

YAMAHA



UCABG

MCX-2000



MCX-2000

Digital Audio Server



OWNER'S MANUAL

© 2005 YAMAHA CORPORATION All rights reserved.

YAMAHA ELECTRONICS CORPORATION, USA 6660 ORANGETHORPE AVE., BUENA PARK, CALIF. 90620, U.S.A.
 YAMAHA CANADA MUSIC LTD. 135 MILNER AVE., SCARBOROUGH, ONTARIO M1S 3R1, CANADA
 YAMAHA ELECTRONIK EUROPA G.m.b.H. SIEMENSSTR. 22-24, 25462 RELLINGEN BEI HAMBURG, GERMANY
 YAMAHA ELECTRONIQUE FRANCE S.A. RUE AMBROISE CROIZAT BP70 CROISSY-BEAUBOURG 77312 MARNE-LA-VALLÉE CEDEX02, FRANCE
 YAMAHA ELECTRONICS (UK) LTD. YAMAHA HOUSE, 200 RICKMANSWORTH ROAD WATFORD, HERTS WD18 7GQ, ENGLAND
 YAMAHA SCANDINAVIA A.B. J A WETTERGRENS GATA 1, BOX 30053, 400 43 VÄSTRA FRÖLUNDA, SWEDEN
 YAMAHA MUSIC AUSTRALIA PTY. LTD. 17-33 MARKET ST., SOUTH MELBOURNE, 3205 VIC., AUSTRALIA

YAMAHA CORPORATION



WF 37460

Printed in Malaysia



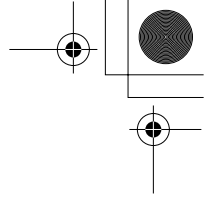

Table of Contents

Table of Contents	2	Applications	46
Preface	3	Playing Audio Sources	46
What's Included	4	Playing Archived Music	46
Feature Overview	4	Adding a Bookmark to a Song.....	50
Audio Playback Functions.....	4	Play Information and Controls.....	50
Audio Recording Functions.....	5	Playing a CD	51
Music Archiving Functions.....	5	Notes on Playing an MP3 CD.....	52
CD Recording Functions.....	5	Listening to a Radio Broadcast	54
Music Streaming Functions.....	6	Listening to FM Radio.....	54
Timer Function.....	6	Listening to XM Radio (US model only).....	55
		Listening to Internet Radio.....	59
		Using the Presets List.....	59
		Playing External Audio Signals.....	63
		Playing Audio Content on the Computer.....	64
		Recording Audio Sources	66
Preparations and Setup	7	Recording Songs from a Music CD.....	66
Panel Descriptions: MCX-2000	7	Recording from FM Radio or External Audio Signals.....	69
Front Panel.....	7	Duplicating a Music CD.....	71
Back Panel.....	9	Recording Archived Songs to a CD.....	73
Panel Descriptions: Remote Control	11	Editing the Library	75
Connecting External Devices	13	Typing Text Characters.....	75
Connecting to the AC Power	13	Editing Song Data.....	77
Remote Control Features and Operations	16	Using a Playlist.....	82
Setting Batteries.....	16	Registering an Internet Radio Station.....	84
Operating on the Remote Control.....	16	Renaming Items from the Radio Presets List.....	85
Using as a Universal Remote Control.....	17	Operating a Client Remotely	87
Menu Operation Basics	19	Selecting the Client Audio Source.....	88
MCX-2000 Menu Tree	22	Setting the Timer Playback.....	89
		Other Features	91
		Setting Date and Time.....	91
Configuring Your MusicCAST Network	23	Using the Online CDDDB Database.....	93
Network Basics.....	23	Defining User Interface.....	93
Configuring a MusicCAST-only Network	25	Selecting Playback Options.....	95
Configuring a MusicCAST Network for PC Network and Internet Access	26	Selecting Recording Options.....	96
		Using the Timer Playback	97
Using Easy Setup	27	Using a Yamaha AV Receiver	98
Easy Setup Overview	28	Managing an Existing MusicCAST Network	100
Date and Time.....	28	Checking the Network Status.....	100
MusicCAST System Configuration.....	28	Initializing Network Settings.....	100
Network Connection (stand-alone, without clients).....	28	Managing the MCX-2000 System	101
Network Connection (with clients).....	29	Viewing System Information.....	102
Network Configuration.....	29	Resetting the MCX-2000 for Factory Settings.....	103
For the MCX-2000 to access the Internet via an existing PC network.....	30	Updating the MCX-2000 Firmware.....	103
For automatic configuration of a MusicCAST network.....	30	Limiting Local Operations on the MCX-2000.....	104
Automatic Configuration of a MusicCAST Network	31	Compatible Media (CD/CD-R/CD-RW)	105
Preparation on the MCX-2000.....	32	About Digital Recording with MusicCAST	107
Preparation on Each Client.....	33	Troubleshooting	108
Automatic Registration of Clients.....	34	Glossary	111
Manual Configuration of a MusicCAST Network	35	Specifications	113
Checking Out Parameter Values.....	35		
Settings on the MCX-2000.....	36		
IP Address.....	37		
Wireless LAN.....	37		
Settings on Each Client.....	39		
Mode.....	40		
Server ID.....	40		
DHCP.....	41		
IP Address.....	41		
Subnet Mask.....	41		
ESS ID.....	42		
WEP Key.....	42		
Manual Registration of Clients.....	43		
Confirming Network Status	44		
Updating Client Firmware	45		

The illustrations and operation screens as shown in this owner's manual are for instructional purpose only, and may appear somewhat different from those on your products.





Preface

Thank you and congratulations on your purchase of the Yamaha MCX-2000 Digital Audio Server!

The MCX-2000 is a music server that enhances the concept of MusicCAST, a digital music delivery method over a personal network.

MusicCAST delivers a new listening style for the digital era. It allows you to record various audio sources, including music CDs, onto the music server, and enjoy streamed playback on a client device (MCX-A10 or MCX-C15, sold separately) placed anywhere in your home, using wired and wireless computer networking technologies.

There are many ways to use the MusicCAST network and the MCX-2000 music server.

Use the MCX-2000 to collect and centralize all music sources in your home. Then, simply place a client device in every room of your house—instead of buying a separate stereo or audio set for each of your family members. This setup lets each member of the family enjoy their own favorite music—in any room at the same time. Naturally, the music server can also be set to stream the same music to each client, so that you can walk around your house and have the same music play no matter where you go.

The MCX-2000 has other great features. It can also stream music or audio programs from the built-in FM radio tuner anywhere in your home via the MusicCAST network. Locally on the MCX-2000, you can also enjoy Internet radio programs. You can also use the MCX-2000 to record audio content from old analog tapes. Once recorded, they can be streamed via the MusicCAST network and burned onto CD-R/RW media for storage purposes, together with songs from music CDs.

The above are just a few examples to show how you can use the MusicCAST network and the MCX-2000 music server. You'll find additional ones throughout this manual, too—so, keep the manual in a safe place and read it thoroughly in order to get the most out of your new MCX-2000.

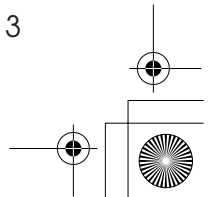
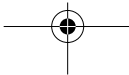
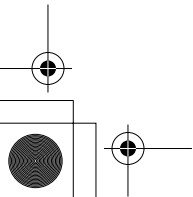
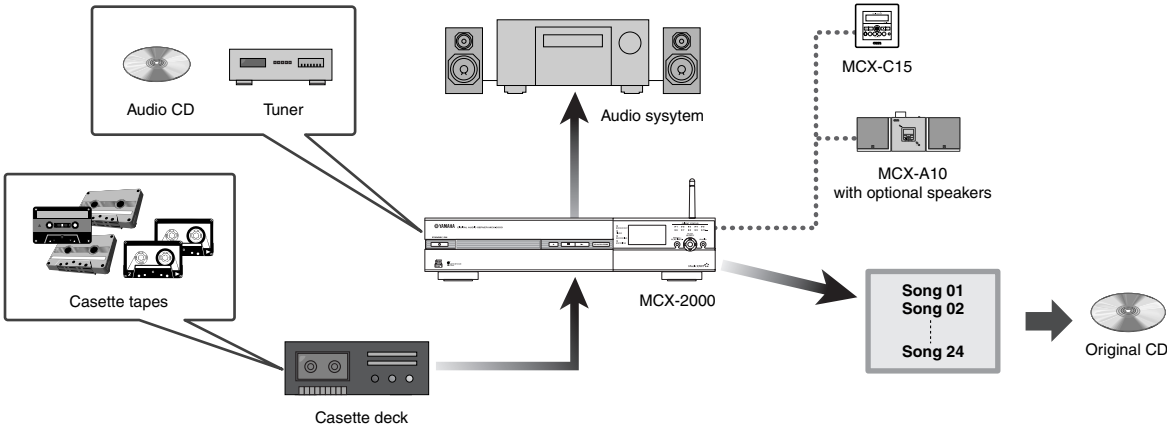
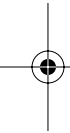

What's Included

The MCX-2000 product package contains the following items. When you open the box, first check they have all been included. If something is missing, please contact the dealer from whom you purchased the product.

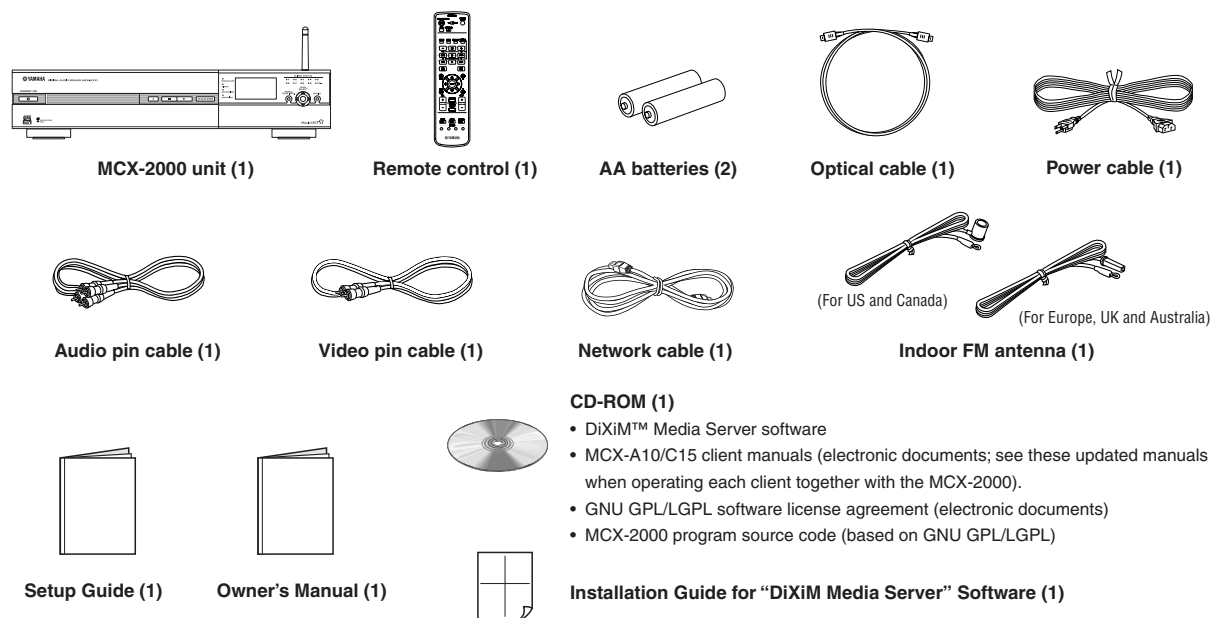

Feature Overview

Designed to be a comprehensive, ultimate audio center for your home, the MCX-2000 incorporates a wide variety of features and functions. Here, we'll take a look at some of ways you can use these features.

Audio Playback Functions

The MCX-2000 lets you play a wide variety of audio sources, including commercial music CDs, your own original MP3 CDs (CD-ROM), external audio signals, and radio programs from the built-in FM tuner. You can also listen to audio content stored on your Windows computer if you connect the MCX-2000 to your computer network (LAN). Since the MCX-2000 can access the Internet through your computer network, you can even enjoy music from your favorite Internet radio stations. When you play these audio sources on the main MCX-2000 itself, connect a speaker system (power amplifier and speakers, or powered speakers) to the unit.

- Playing Archived Music (page 46)
- Playing a CD (page 51)
- Listening to FM Radio (page 54)
- Listening to Internet Radio (page 59)
- Playing External Audio Signals (page 63)
- Playing Audio Content on the Computer (page 64)

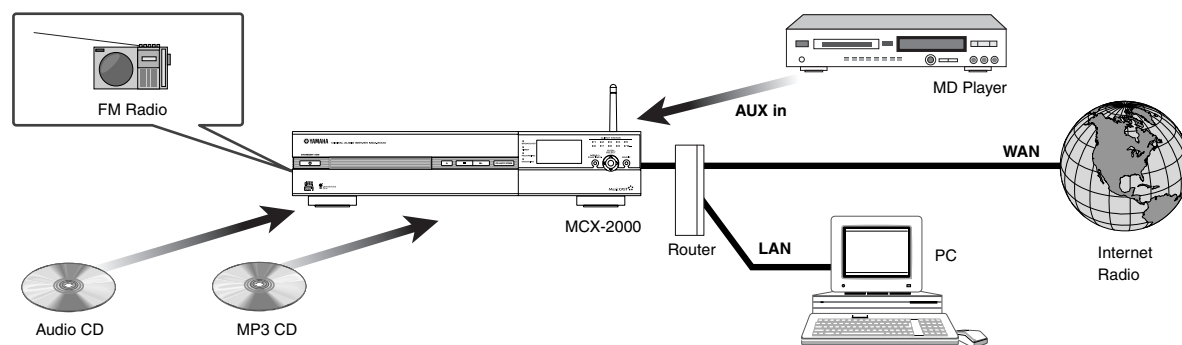

Audio Recording Functions

The MCX-2000 incorporates a large-capacity 160GB hard disk drive, allowing up to 200 hours of digital recording in linear PCM format (16-bit/44.1kHz) or up to 2,000 hours in MP3 format (160kbps bit rate). Recordable audio sources include commercial music CDs, external audio signals, and radio programs from the built-in FM tuner.

- Recording Songs from a Music CD (page 66)
- Recording from FM Radio (page 69)
- Recording External Audio Signals (page 69)

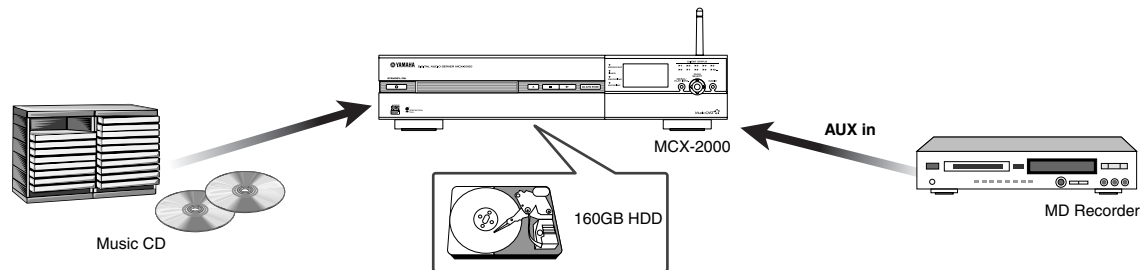

Music Archiving Functions

When recording audio sources, you can add information to each song—such as the song title, artist name, album name and genre—then store it to the music archive in the MCX-2000 hard drive. This information can then be used to find specific songs you want to play. Because the MCX-2000 incorporates a special song database system (based on Gracenote CDDB®), this information will be set automatically if your songs are from popular music CDs. Other useful functions include Playlist and Bookmark, letting you create custom song lists appropriate to specific occasions (such as parties, morning ‘wake-up’ music, etc.) and allowing you to mark your favorite tunes for quick access.

- Adding a Bookmark to a Song (page 50)
- Typing Text Characters (page 75)
- Editing Titles (page 77)
- Changing Song Attributes (page 77)
- Using a Playlist (page 82)
- Registering an Internet Radio Station (page 84)

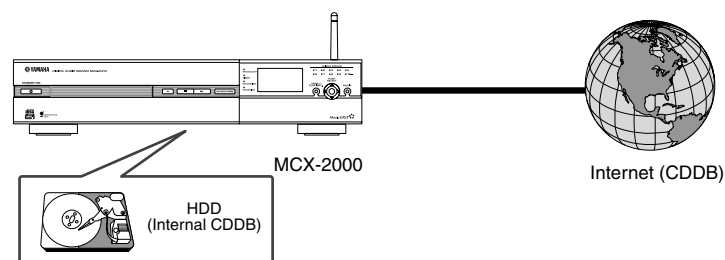

CD Recording Functions

This function lets you create a music mix CD of your own selections by arranging archived songs in your favorite order. You can also use this function to duplicate existing music CDs, allowing you to copy your personal mixes to CD and give it to your friends.

- Recording Archived Songs to a CD (page 73)
- Duplicating a Music CD (page 71)

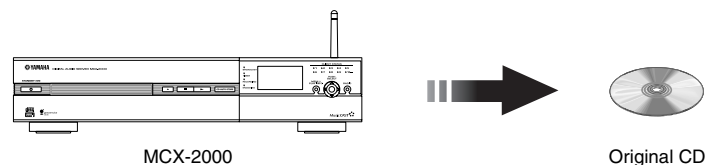

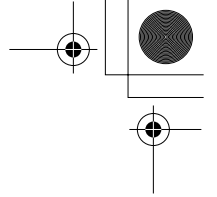

Music Streaming Functions

Once songs are archived (recorded) on the MCX-2000 hard drive, you can stream them to up to 15 clients via the MusicCAST network. The MCX-2000 can deliver the same music to each client simultaneously (broadcast). It can also deliver different songs to different clients at the same time, at the request of each client. In addition, the MCX-2000 supports remote control of clients via the MusicCAST network, allowing you to operate them without having to go to each unit individually.

- MusicCAST as an Integrated Music Delivery System (page 89)
- Operating a Client Remotely (page 87)

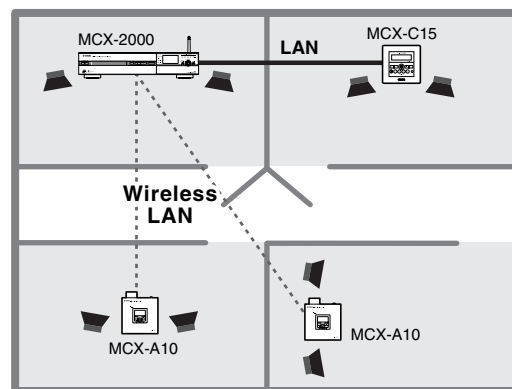

Timer Function

The MCX-2000 and clients incorporate a timer that enables song playback at a specified time. You can program up to ten playback timer instances for each MusicCAST device.

- Setting the Timer Playback (page 89)
- Using the Timer Playback (page 97)

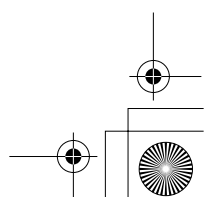
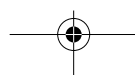
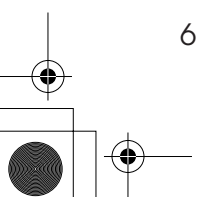
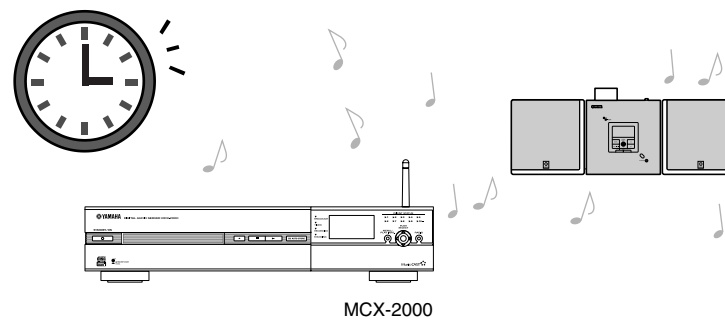

Preparations and Setup

This section explains how to connect peripheral devices to your MCX-2000 and set it up as a music server, and how to create a MusicCAST network in conjunction with clients (MCX-A10 or MCX-C15, sold separately).

Panel Descriptions: MCX-2000

Front Panel

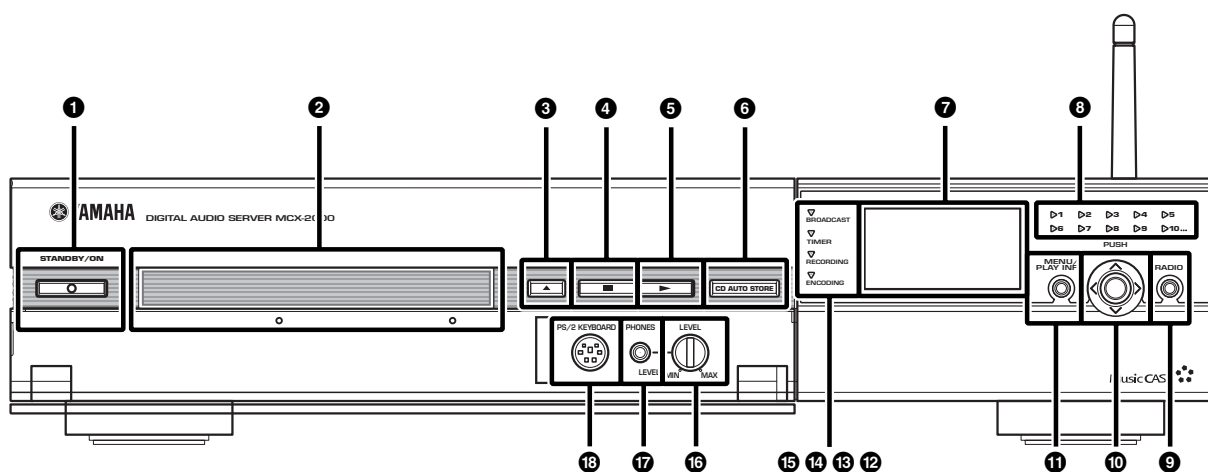

1 STANDBY/ON button

Use this button when switching among the MCX-2000 operating modes. The button indicator light changes color, showing the unit's current operating mode (green: active mode, amber: sleep mode, red: standby mode).

- Connecting to the AC Power (page 13)

2 Disc tray

3 Open/Close button (▲)

Use these when setting a CD in the MCX-2000. Press this button to open the tray, set a CD with its label side facing up, and press the button again to close the tray.

4 Stop button (□)

5 Play button (▷)

Press the Play button to start playback of the current song from the beginning. Press the Stop button to stop playback of the current song that's being played. These buttons similarly works with all other audio sources available on the MCX-2000 (CD, archived songs, radios, external inputs).

6 CD AUTO STORE button

Use this button when recording (storing) all songs from a music CD at a time. Since importing an entire CD is possible with a single click of the button, you can quickly store a number of songs from a pile of music CDs into the MCX-2000 music archive.

- Importing a Music CD Automatically (page 68)

7 Display

Shows the current MCX-2000 status or menu screen.

8 CLIENT STATUS indicators (1~10)

Each indicator is associated with a client registered to the MCX-2000. A client whose indicator lights up in green is properly connected, and can receive audio streams from the MCX-2000. The 10th indicator (10...) shows the operating status for the 10th and following clients all together. You can view detailed information of each client's status in the Client Control screen.

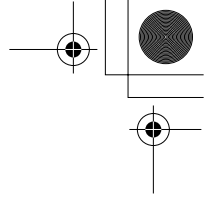

9 RADIO button

Press this button to fast access the last selected radio station. Every time you press this button, the radio type cycles through FM, XM, Internet Radio and Presets (XM is for US model only).

10 Cursor controller

Delivers the same functions with the center controller on the remote control. You can move the highlight (selection) onto a target item by pushing the center stick upward, downward, leftward or rightward. When you press this stick vertically, it determines to select the current item (PUSH SELECT).

11 MENU/PLAY INFO. button

Press this button to toggle between the last selected menu screen and the Play Information screen for the current song. Continue pressing this button for the Top Menu screen.

12 BROADCAST indicator

Lights up in blue while the MCX-2000 is broadcasting to clients.

13 TIMER indicator

Lights up in amber while the MCX-2000 is waiting or operating in timer playback mode.

14 RECORDING indicator

Lights up in red while the MCX-2000 is recording (storing) an audio source or writing onto a CD-R/RW disc.

15 ENCODING indicator

Lights up in green while the MCX-2000 is encoding recorded audio into MP3 format.

16 LEVEL knob

17 PHONES jack

Connect a pair of headphones here to listen to sounds being played on the MCX-2000. You can adjust the playback volume using the LEVEL knob.

18 PS/2 KEYBOARD port

Connect a generic PS/2 keyboard designed for PC here. A connected PS/2 keyboard lets you control the MCX-2000 in the same way as the supplied remote control. It also lets you type words (such as song titles) quickly when editing song information. In addition, the MCX-2000 doesn't support a PS/2 mouse. So, don't connect a PS/2 mouse to this port.

- Typing Text Characters (page 75)

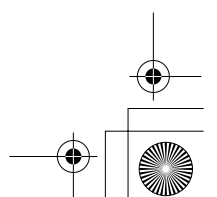
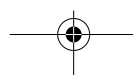
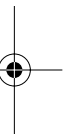

Back Panel

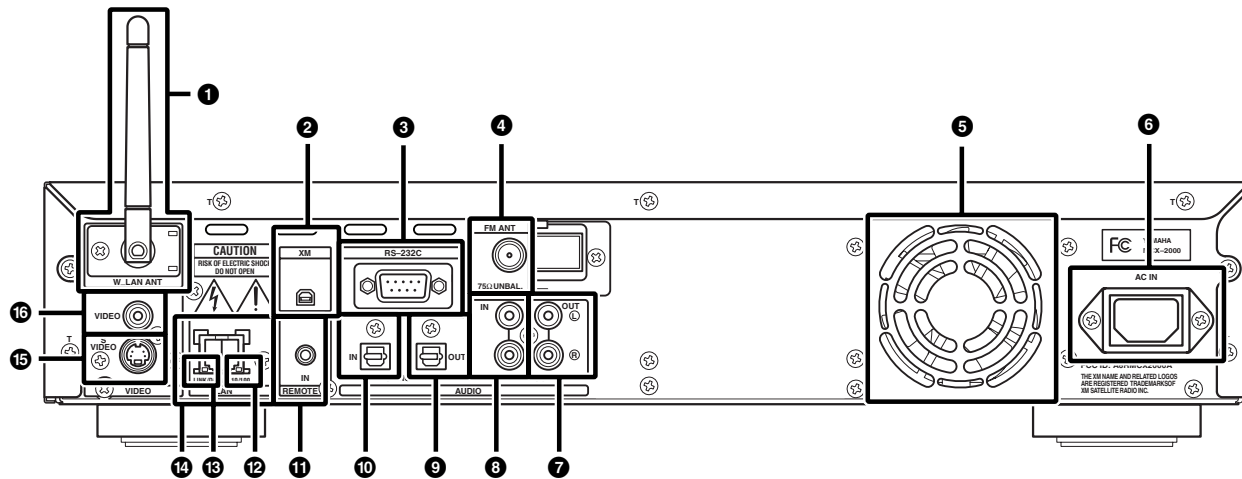

1 W_LAN ANT

A movable antenna for the wireless network. When you stream audio to clients over the wireless network, adjust the antenna angle for best results.

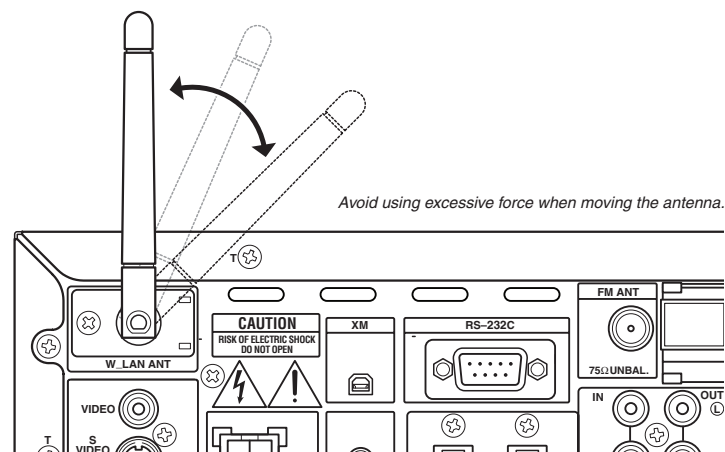

2 XM jack (US model only)

If you live in the United States and want to listen to XM Satellite Radio on the MCX-2000, connect your XM Connect-and-Play antenna here (page 55).

3 RS-232C port

Use this port when connecting the MCX-2000 to a compatible Yamaha AV receiver using an RS-232C cross cable. With this setup, you can synchronize both units' power on/off timing or automatically select a surround program on the AV receiver to match the genre of a song you select on the MCX-2000.

- Using a Yamaha AV Receiver (page 98)

4 FM ANT terminal

Connect the supplied indoor FM antenna here when using the MCX-2000 built-in FM tuner.

5 Fan opening

To effectively cool down the inside of the MCX-2000, be sure not to shut off the airflow from this opening. When placing the MCX-2000 near a wall, make sure there is enough room behind the back panel.

6 AC IN socket

Connect the supplied power cable here.

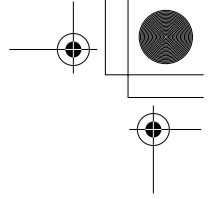

7 ANALOG OUT jacks (stereo)

9 OPTICAL OUT jack (stereo)

Audio playback signals on the MCX-2000 are output from these jacks. Use the supplied optical digital cable (or one purchased separately) to connect the OPTICAL OUT jack to a digital audio input on an external device. Use the supplied stereo pin cable (or one purchased separately) to connect the ANALOG OUT jacks to analog audio input jacks on an external device.

8 ANALOG IN jacks (stereo)

10 OPTICAL IN jack (stereo)

Audio sources called 'external input' in this manual are incoming audio signals via these jacks. Use the supplied optical digital cable (or the one purchased separately) to connect the OPTICAL IN jack to a digital audio output on an external device. Use the supplied stereo pin cable (or one purchased separately) to connect the ANALOG IN jacks to analog audio output jacks on an external device.

11 REMOTE terminal

This terminal is designed for professional expansion purposes, not for consumer use of the MCX-2000.

12 10/100 indicator

13 LINK/DATA indicator

14 LAN (Ethernet) port

Connect a network cable (CAT-5 straight cable) to the Ethernet port when creating a wired network with clients or connecting the MCX-2000 to your home network. The LINK/DATA indicator lights up when the wired connection is properly working, and flashes when data traffic over the network is being done. The Ethernet port is automatically configured to match the speed of a connected network (10 or 100 Mbps); the 10/100 indicator lights up when the Ethernet port is configured for 100 Mbps, and is unlit for 10 Mbps.

15 S-VIDEO port

16 VIDEO port

These ports output the MCX-2000 operating screen displays (OSD) to an external TV monitor. Connect either port to your TV monitor's video input (yellow-coded composite port for VIDEO, or 4-pin S port for S-VIDEO). The VIDEO and S-VIDEO ports output the same displays.

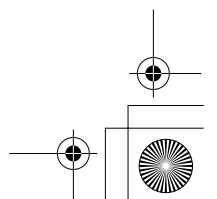
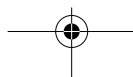
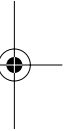

Panel Descriptions: Remote Control

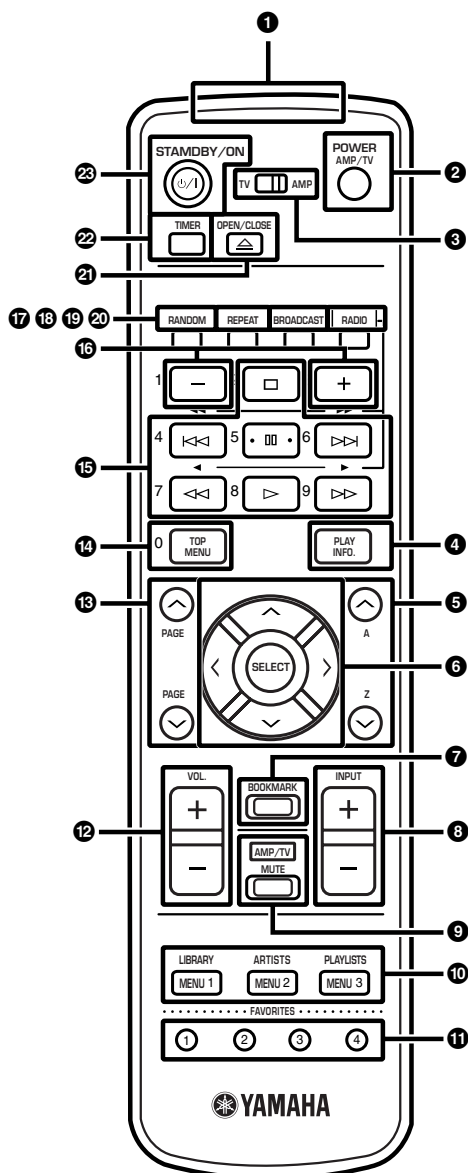

1 IR transmitter

Infrared (IR) remote control signals are transmitted from here. When operating the remote control, point this part at the IR receiver on the target unit.

4 PLAY INFO. button

Press this button to show the Play Information (song data) screen for the current song on the TV monitor.

5 Alphabetical index search buttons (^ / v)

You can find a recorded (archived) song from one of groups (artists, albums, genres or all songs). Whichever group you select, its contents (artist names, album titles, genres or song titles) are listed in alphabetical order. You can then press either button to jump to the first item in each alphabetical index. Use the down arrow button to jump in an A-to-Z direction, or the up arrow button to jump in a Z-to-A direction.

- Selecting a List Item (page 48)

6 Cursor controller

Provides the same functions as the controller on the MCX-2000 front panel. Use the up, down, left and right arrow buttons to move the highlight (selection) onto a target item, and then press the center SELECT button to select or determine it.

7 BOOKMARK button

Press this button to add or remove the bookmark to the current song.

- Adding a Bookmark to a Song (page 50)

2 POWER AMP/TV button

3 TV/AMP switch

8 INPUT buttons (+/-)

9 MUTE button

12 VOL. buttons (+/-)

In addition to operating the MCX-2000, the supplied remote control also lets you operate compatible Yamaha AV receivers and TV monitors from other manufacturers (page 17). Slide the TV/AMP switch to TV to control the TV monitor, or to AMP to control a Yamaha AV receiver. You can then use the POWER AMP/TV button to turn the target device on or off, the VOL. buttons to adjust the volume level of the target device, and the MUTE button to temporarily turn off the target device volume. Press the MUTE button again to cancel muting. The INPUT buttons let you switch the input source on the target device. So, you can even route a different audio source from the Yamaha AV receiver to the MCX-2000 external input. In addition, directional switching with the INPUT +/- buttons only works with Yamaha AV receivers. TV input will be switched in the same direction with either INPUT button.

- Using as a Universal Remote Control (page 17)

10 MENU 1~3 buttons

Use the MENU 1~3 buttons to fast access the Library, Artists and Playlists menu screens.

11 FAVORITES 1~4 buttons

The FAVORITES 1~4 buttons are reserved for future use (no functions).

13 PAGE scroll buttons (^ / v)

When a list of items (such as songs from a CD) cannot be displayed at a time, press either button for a scrolled view of the list.





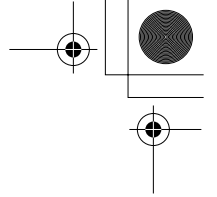

14 TOP MENU button

Press this button to immediately access the Top Menu screen whatever screen is shown on the TV monitor.



15 Playback control buttons

You can control playback on the MCX-2000 using:

- Pause button () to pause or resume playback of the current song
- Skip backward button () to go to the beginning of the previous song (or the current song during playback)
- Skip forward button () to go to the beginning of the next song
- Stop button () to stop playback of the current song and rewind to its beginning
- Backward button () to scrub playback toward the beginning of the current song
- Forward button () to scrub playback toward the end of the current song
- Play button () to start playback from the beginning of the current song

16 Group selection buttons (-/+)

Press this button to select the previous (-) or next (+) group within the currently selected group (album, artist, genre or the like).

17 RANDOM button

Every time you press this button, you can change the playback order of songs from the current group (album, artist, genre or all songs) as listed, or at random.

- Play Information and Controls (page 50)

18 REPEAT button

Every time you press this button, you can change how to repeat playback of the current song(s).

- Play Information and Controls (page 50)

19 BROADCAST button

Press this button to start or stop broadcasting to selected clients.

- MusicCAST as an Integrated Music Delivery System (page 89)

20 RADIO button

Press this button to fast access the last selected radio station. Every time you press this button, the radio type cycles through FM, XM, Internet Radio and Presets (XM is for US model only).

21 OPEN/CLOSE button

Like the Open/Close button on the MCX-2000 front panel, use this button when setting a CD in the MCX-2000. Press this button to open the tray, set a CD with its label side facing up, and press the button again to close the tray.

22 TIMER button

Press this button to enable or disable the MCX-2000 Timer function.

- Using the Timer Playback (page 97)

23 STANDBY/ON button

Use this button when switching the MCX-2000 operating modes.

- Operation Modes on the MCX-2000 (page 14)

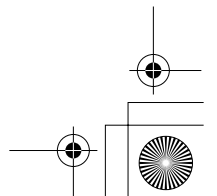
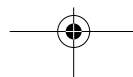
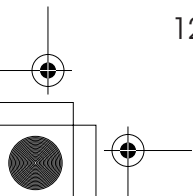
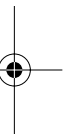
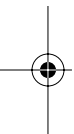

Connecting External Devices

Connect all relevant devices referring to the section “Panel Descriptions” (page 7) and the setup illustration below. Make sure each device is turned off before making connections.

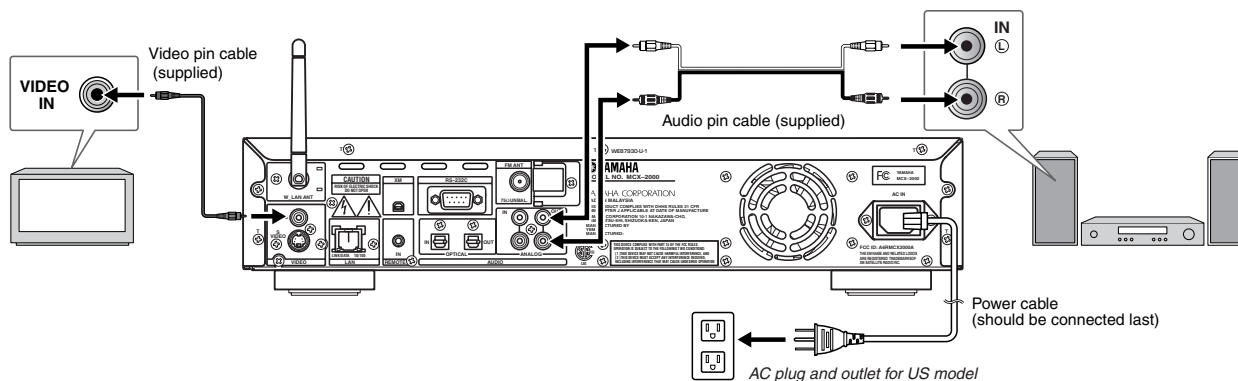

- The MCX-2000 is designed to connect to a TV monitor for easy operation. Though you can still operate the unit while viewing its front panel display, a large TV display offers more operation information at a time.
- The MCX-2000 accepts a generic PS/2 keyboard. This enables faster, more convenient operation than the remote control or front-panel buttons, especially when you edit song information or other text data.
- The MCX-2000 is designed to become active immediately after the power cable is connected to the AC power source. Make sure to connect to the AC power source only in the last step after all other devices are connected.

Connecting to the AC Power

When relevant external devices are all connected, turn on these devices first, and then connect the MCX-2000 power cable to the AC power source.

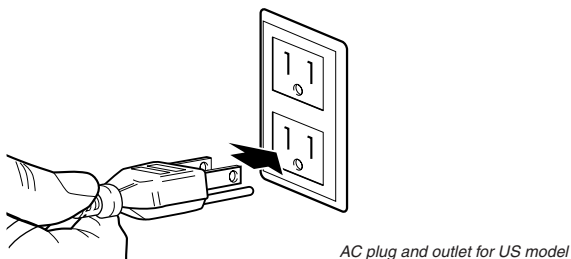

The front panel STANDBY/ON button indicator will light up in green. On the TV monitor, switch the video input source to the MCX-2000 video output (VIDEO or S-VIDEO). If the following screen is shown on the TV display, connection to the TV monitor has been successful.

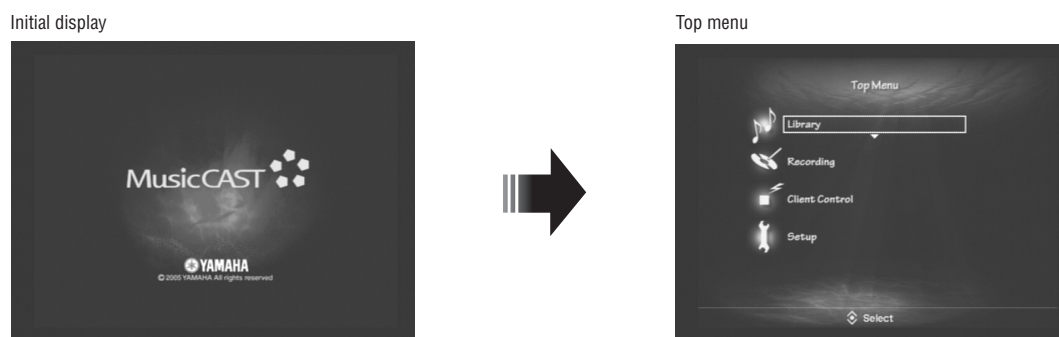

You can call up any necessary operation by selecting a menu item from the Top Menu. In addition, when you turn on the MCX-2000 for the first time after purchase, or after the system reset operation (page 103), the Easy Setup screen (page 27) will appear instead of the Top Menu screen.



NOTE If the indicator light of the STANDBY/ON button turns amber or red, press the button to continue working on the MCX-2000. The unit is designed to automatically go into an energy saving mode if no operations have been performed for a while. Read the following column for more information.

Operation Modes on the MCX-2000

The MCX-2000 has no switch to completely turn the unit off. When you connect the MCX-2000 to the AC power source, the front panel STANDBY/ON button indicator lights up in green and the MCX-2000 enters active mode. In this mode, you can record or play an audio source while viewing the built-in display or the TV monitor.

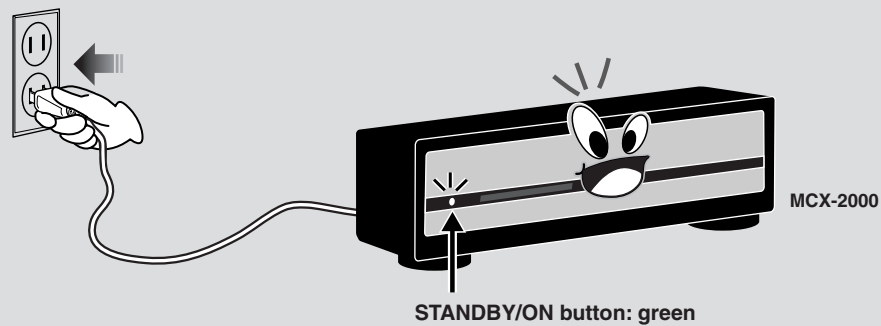

When you press the STANDBY/ON button on the remote control or the unit's front panel, the front panel STANDBY/ON button indicator light turns amber, and then the MCX-2000 enters sleep mode. In this mode, the MCX-2000 stops showing a screen on the TV monitor and built-in display, waiting for a client request or your remote control operation.

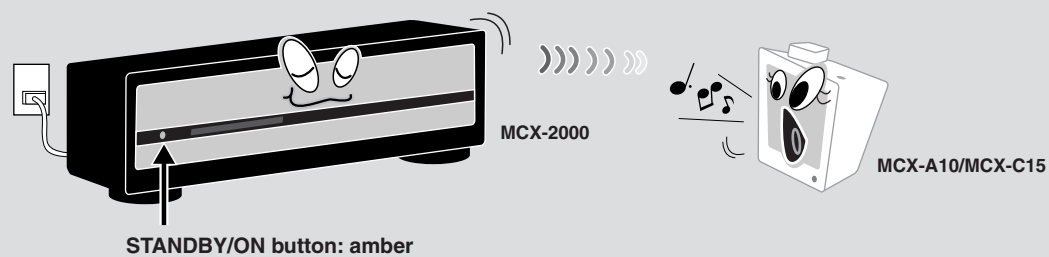

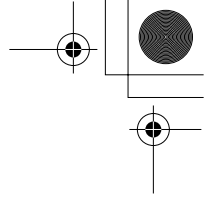

When you press the power switch on a client, it immediately establishes a network connection with the MCX-2000 and enters active mode. (The corresponding CLIENT STATUS indicator lights up on the MCX-2000.) The client shows Top Menu in the backlit display, and gets ready to play a streamed song from the MCX-2000.

As mentioned above, even in sleep mode, the MCX-2000 can still respond to a request from any registered client. This is because the MCX-2000 maintains network connections with clients. As long as network connections are maintained, the MCX-2000 can continue streaming music to clients. In fact, clients can continue playing a streamed song if the MCX-2000 later enters sleep mode.

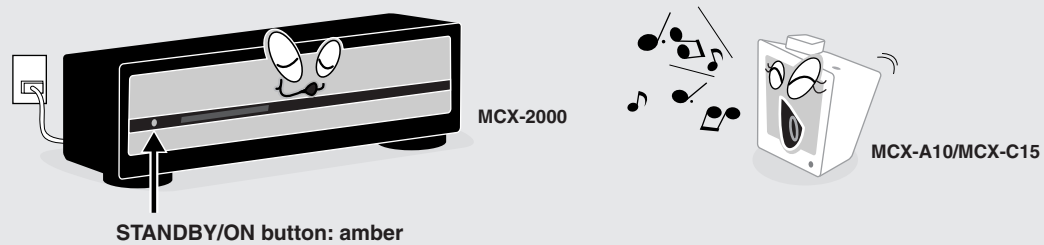

If you hold down the STANDBY/ON button for more than 3 seconds when the MCX-2000 is in active or sleep mode, the indicator light turns red and the MCX-2000 enters standby mode, where the unit consumes less power. In standby mode, network activities between the MCX-2000 and clients stop. (All CLIENT STATUS indicators go off on the MCX-2000.) In this process, all active clients also enter sleep mode (Remote Sleep). They stop playing a streamed song (because of no network connection with the MCX-2000), and show the current time in the display without backlight. In sleep mode, clients wait for your operation and can awake the MCX-2000 to resume music streaming.

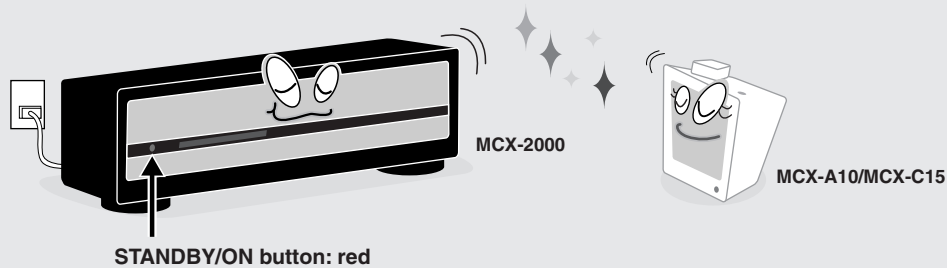

Let's say, standby mode is deep sleep. When a client sends a request, the MCX-2000 in standby mode notices it and enters 'lighter' sleep mode. (The STANDBY/ON indicator light turns amber.) Otherwise, you can press the STANDBY/ON button to completely awake the MCX-2000 and make it enter active mode. (The STANDBY/ON indicator light turns green.) But, when the MCX-2000 directly enters active mode from standby mode, it first must re-establish network connections with clients, taking more time to resume network activities or music streaming.

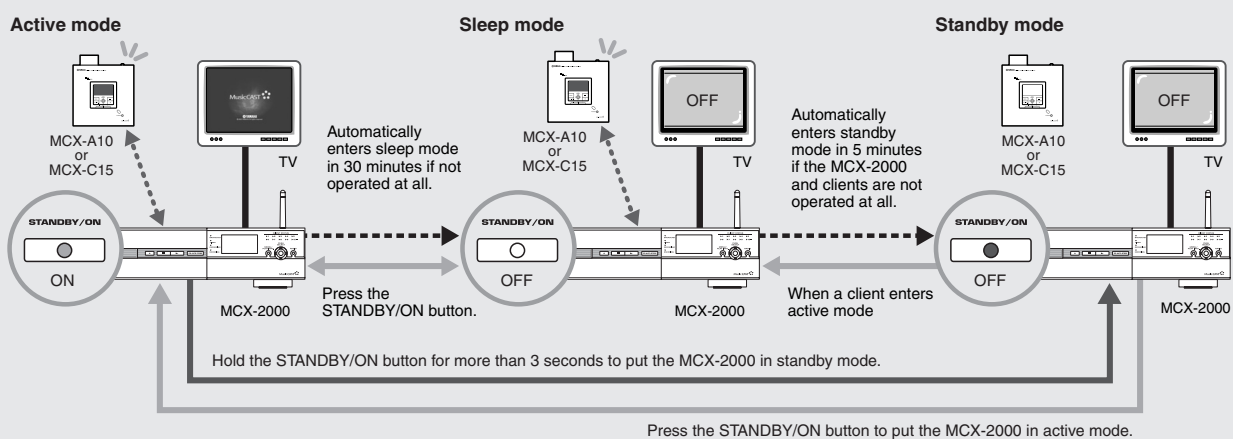

NOTE The MCX-2000 enters standby mode if it's been idle (with no operation on the unit or no network activities) for one hour.

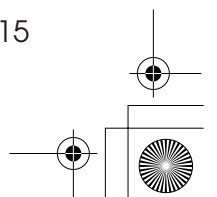
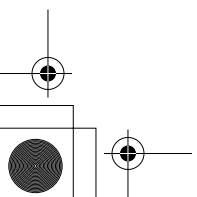

Remote Control Features and Operations

You can use the supplied remote control to do most of the MCX-2000 operations (such as selecting a menu item or determining a setting value). Prepare the remote control before operations.

Setting Batteries

Set batteries inside the remote control as shown below.

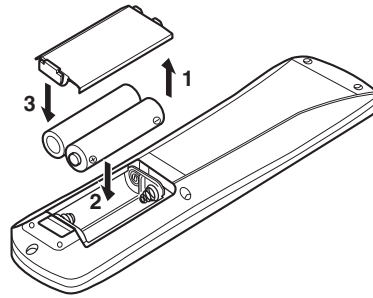

- 1 Remove the bottom cover of the remote control.
- 2 Set two AA batteries (supplied) in appropriate directions, according to the illustration in the compartment.
- 3 Slide the cover until it snaps into place.

NOTE If the remote control doesn't work well, the batteries may be weak. Replace them with generic two AA batteries. Always handle batteries appropriately, according to the safety precautions at the beginning of this manual.

Operating on the Remote Control

When operating on the remote control, direct the IR transmitter to the IR receiver on the MCX-2000 front panel.

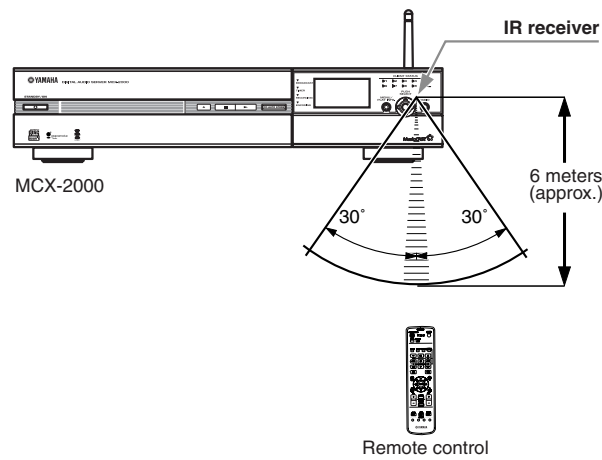

Using as a Universal Remote Control

The supplied remote control can be used as a universal (multi-platform) remote control, letting you operate TV monitors from other manufacturers. The remote control supports TV monitors from manufacturers (brands) in the following list. So, if your TV monitor is applicable, select and register the corresponding preset setting to enable the universal control feature.

NOTE The supplied remote control also supports a compatible Yamaha AV receiver that's connected to the MCX-2000 using an RS-232C cross cable (page 98). You can use the remote control for power on/off, volume adjustment (including mute) and input selection on the connected AV receiver.

	ID					
Yamaha	42	87	92	53		
Admiral	16	92	93			
Aiwa	76	83	94			
Akai	95	96				
Alba	96					
AOC	97					
Bell&Howell	92					
Bestar	98					
Blaupunkt	22	29				
Blue sky	98					
Brandt	23					
Brocsonic	97					
Bush	96					
Clatronic	98					
Craig	24					
Croslex	25					
Curtis Mathis	26	97				
Daewoo	24	27	28	97	98	
Daytron	39					
Dual	98					
Dwin	81	93				
Emerson	24	32	39	97		
Ferguson	23	65	66			
First line	98					
Fisher	33	95				
Fraba	98					
Fujitsu	89					
Funai	77	78				
GE	34	35	36	93	97	
Goodmans	23	96	98			
Grundig	29	49				
Hitachi	39	42	43	97		
ICE	96					
Irradio	96					
Itt/Nokia	44					
JC Penny	34	37	93	97		
JVC	46	47	96			
Kendo	98					
KTV	39	97				
LG/Goldstar	37	39	97	98		
Loewe	48	98				
LXI	25	26	33	93	97	
Magnavox	25	39	97			
Marantz	10	98				
Matsui	95					
Memorex	16	97				
Mitsubishi	59	87	97			
Nad	26	55				
NEC	52	82	97			
Nokia	44					
Nokia Oceanic	44					
Nordmende	65	66				
Onwa	96					
Panasonic	34	35	36	53		
Philco	25	39	97			

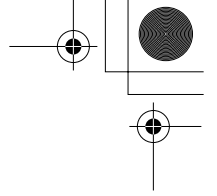

Philips	25						
Pioneer	26	35	54	55	68		
Portland	56	97					
Proscan	21	31	41	51	93		
Proton	50	60	70	97			
Quasar	34	35					
Radio Shack	87	93	97				
RCA	21	34	56	57	58	93	97
Runco	20	30	71				
SABA	23	65	66	69			
Sampo	80	81	97				
Samsung	39	48	62	75	97		
Sanyo	33	73	79	95			
Schneider	96						
Scott	97						
Sharp	32	39	92				
Siemens	29						
Signature	16	92					
Sony	63						
Sylvania	25	97					
Symphonic	17	18	19				
Telefunken	64	65	66	69			
Thomson	23	66					
Toshiba	26	67	92				
Videch	42	97					
Wards	16	32	39	97			
Zenith	16	61	71				

NOTE Your TV monitor may not be fully controllable even when it's from a manufacturer (brand) in the above list, depending on the model type or production year. If this is the case, use the remote control for your TV monitor.

Registering Your TV Monitor to the MCX-2000

To enable universal operations from the supplied remote control, select the preset setting for your TV monitor brand.

- 1 Press the TOP MENU button on the remote control to show the Top Menu screen.
- 2 Input a 2-digit brand code for your TV monitor from the above list, using group selection, playback control and TOP MENU buttons (these buttons work as numeric keys; see the corresponding number printed on the left of each button) while holding down the POWER AMP/TV button.

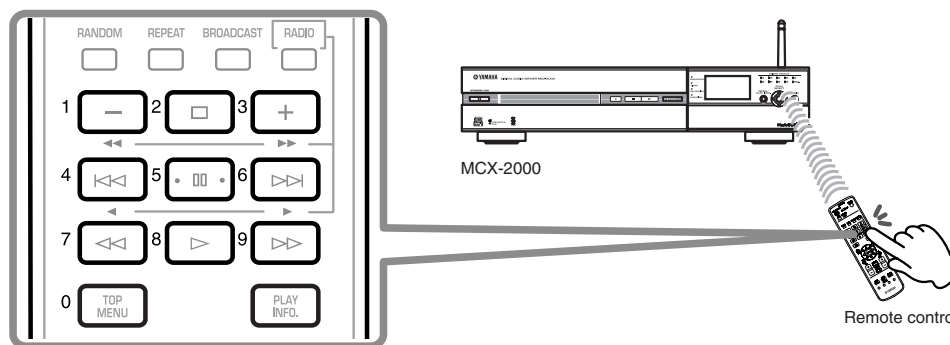

- 3 If the brand code is successfully registered, a message will be shown telling it on the TV monitor and the MCX-2000 built-in display.
- 4 Set the AMP/TV switch to TV, and try operating your TV monitor. If the universal feature is fully working, you can remote control of power on/off, switching of video inputs, volume and muting on your TV monitor.

NOTE If there are two or more brand codes available for TV monitor, register one at a time in the above steps. Use the one that best works for your TV monitor.

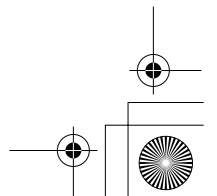
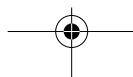
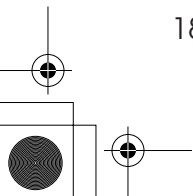

Menu Operation Basics

The MCX-2000 has a menu tree that categorizes all commands, functions and settings relevantly. You can access them by simply selecting a necessary menu item starting with Top Menu. For example, if you want to listen to a music CD, select Library from Top Menu, and then select CD in the next screen.

- 1 Set a music CD in the MCX-2000 first, and then press the TOP MENU button on the remote control to view the Top Menu screen.

For quick access to Top Menu

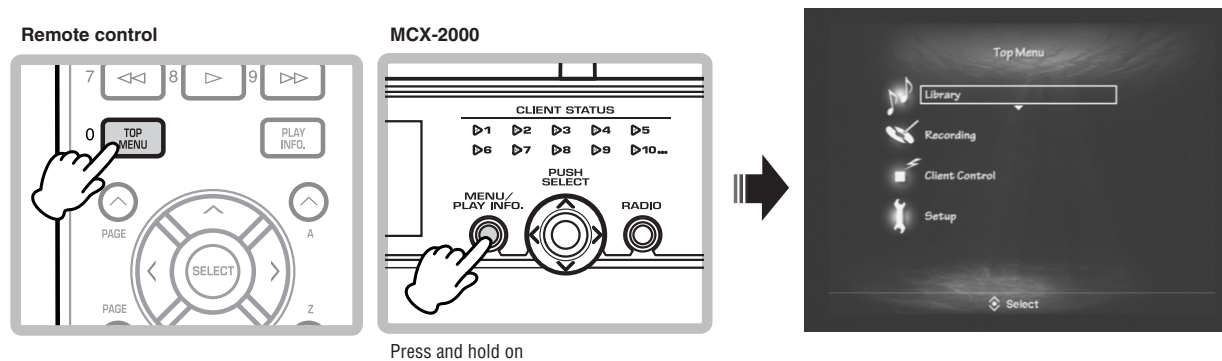

- 2 Select Library from Top menu.

To select a menu item, use the cursor controller on the remote control or the MCX-2000 front panel. Vertically move the highlight (selection) by pressing the up or down arrow buttons on the remote control, or by pushing the center stick upward or downward on the front panel, and then determine your selection by pressing the center SELECT button on the remote control or by 'vertically' pushing the stick (PUSH SELECT) on the front panel.

Selecting a menu item

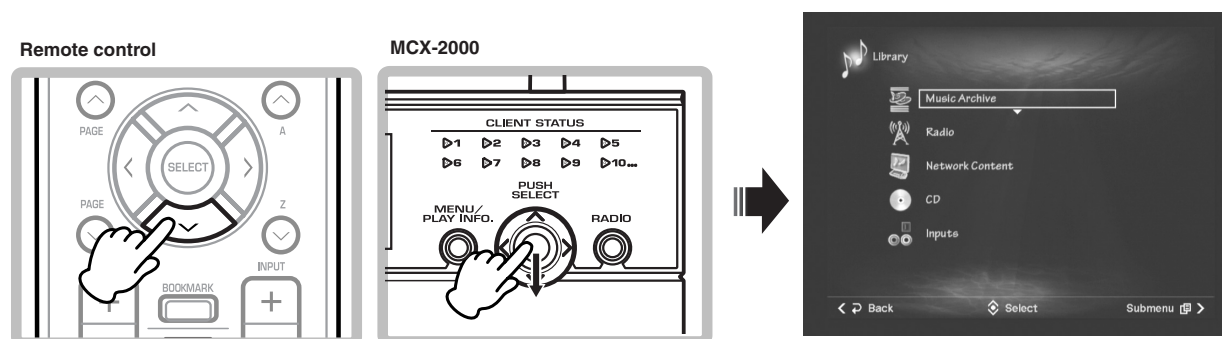

- 3 To return to the previous screen (Top Menu in this case), press the left arrow button on the remote control, or push the center stick leftward on the front panel.

Returning to the previous screen

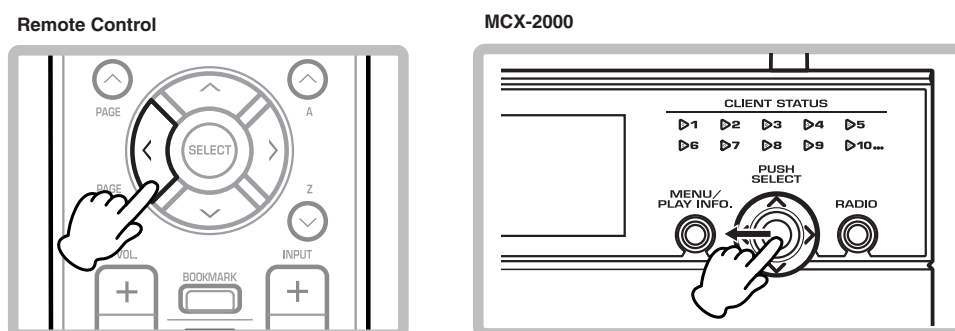

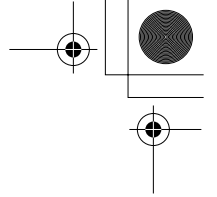

- 4 Now you learned how to go back and forth between screens. Re-select Library from Top Menu, and then select CD as target audio source. Your TV monitor and the built-in display will show a list of songs from the music CD.

TV monitor:

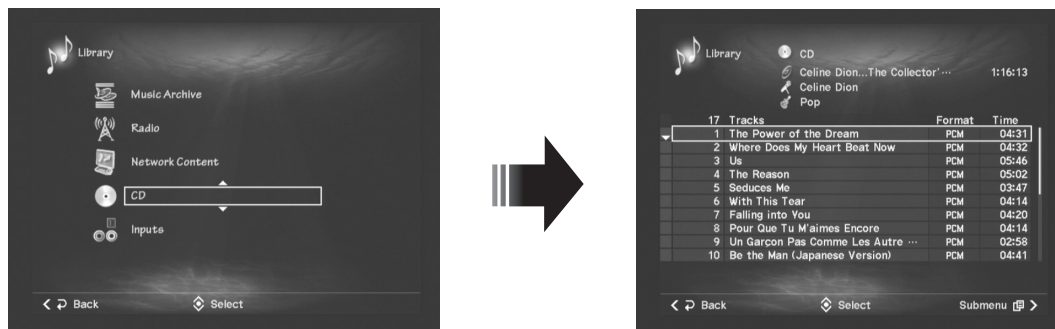

Built-in display:



- 5 You can start playing the CD, from the first song in the list, by pressing the Play button on the remote control or on the MCX-2000 front panel. Otherwise, you can first select your favorite song from the list using the cursor controller, and then start playback from that song.

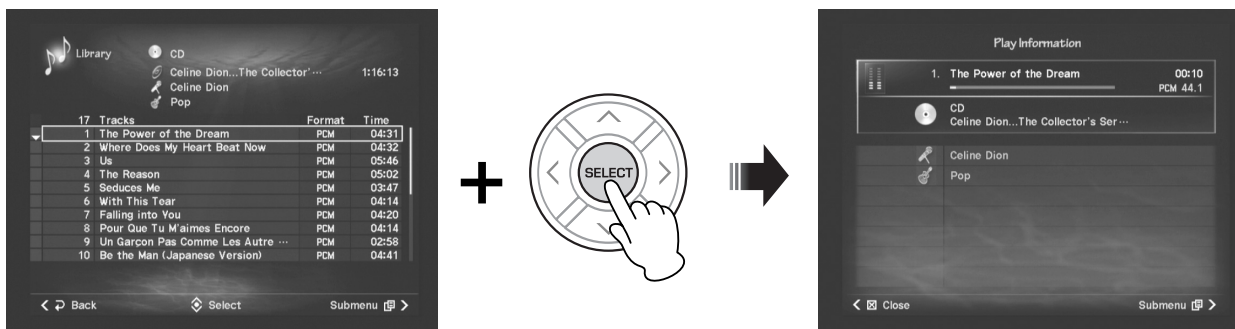

The MCX-2000 also offers Submenu. When the current screen shows "Submenu" in the lower right corner, try pressing the right arrow button on the remote control, or try pushing the center stick rightward on the front panel cursor controller. For example, you can see the following Submenu commands from the CD song list screen.

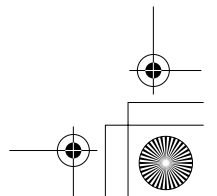
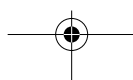
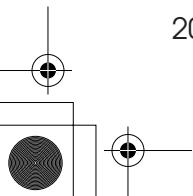

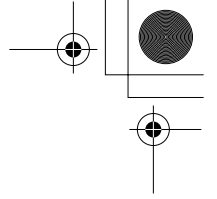

Submenu is context-sensitive, so available menu commands may change depending on which screen or item you open the menu from. You can always do relevant operations to the current selection, such as song playback or recording when you open the Submenu from the CD song list screen. We urge you to check what commands are available from which item or screen every time you find “Submenu” in the lower right corner of a screen. In addition, you can always close the Submenu by pressing the left arrow button on the remote control, or by pushing the center stick leftward on the front panel cursor controller.

NOTE Some screens offer a context-sensitive menu guided with a different name (such as Fix), depending on their functions. But, you can operate all menu commands similarly.

You may see one or more guide icons at the bottom of each MCX-2000 screen. These allow you to perform certain operations by pressing guided buttons on the cursor controller. In most cases, you can return to the previous screen (left arrow button), open the Submenu (right arrow button) and move the highlight between items (up and down arrow buttons) on the cursor controller.

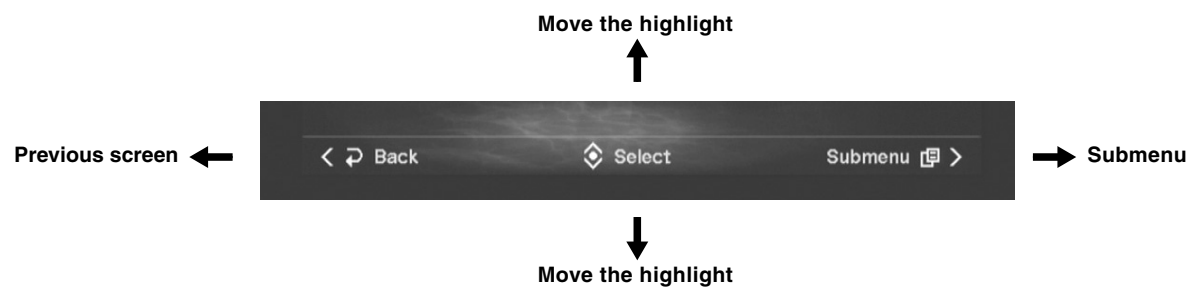

If a screen has setting options or other configurations, the MCX-2000 will show OK and Cancel at the bottom of the screen, asking your confirmation. In this case, you need to select either to exit from the screen. When you select OK (move your selection to OK and press the SELECT button), the MCX-2000 saves the current settings, and then you will return to the previous screen. When you select Cancel, setting changes (if any) are discarded, and then you will return to the previous screen.



NOTE Other special operations include typing text through a character palette (page 75).

In any case, you can perform most operations of the MCX-2000 using the cursor controller to simply move to a target item and select it. Simple and easy!

In addition, this manual describes menu operations to access a specific item in the order of ‘what you select next’. For example, menu operations to the CD song list screen are described as: Top Menu > Library > CD. You can also refer to the MCX-2000 menu tree on the next page to locate each function.

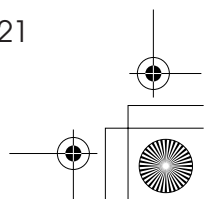
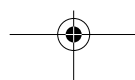
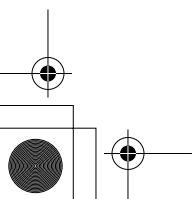

MCX-2000 Menu Tree

This helpful menu tree shows all of the operation screens of the MCX-2000 in hierarchical order. Page numbers are given for convenient reference.

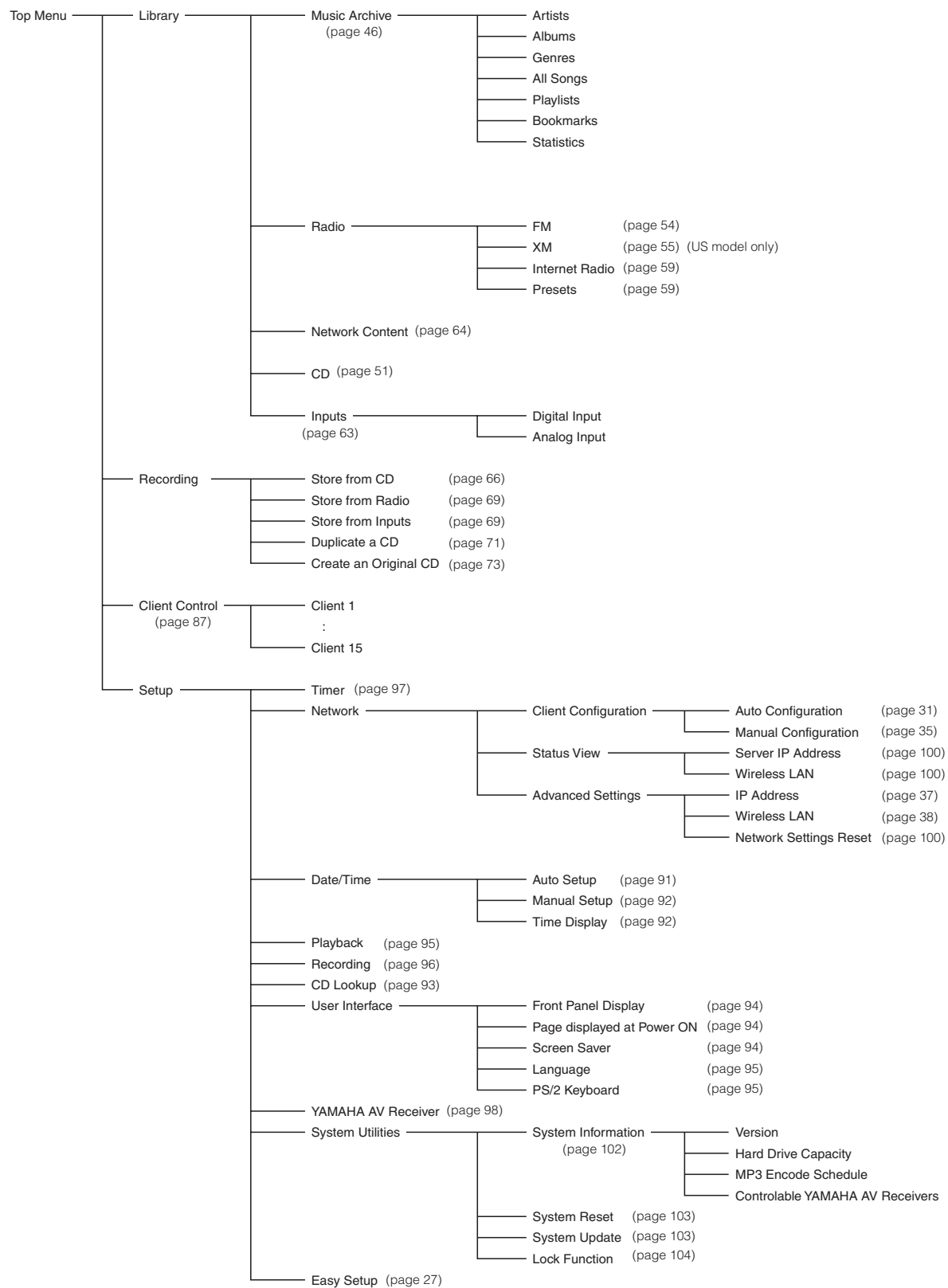

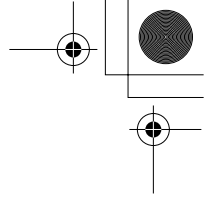

Configuring Your MusicCAST Network

After connecting necessary devices and cables to the MCX-2000 music server and clients (optional MCX-A10 or MCX-C15, or both), you can now configure a MusicCAST network customized for your specific needs. The MusicCAST network uses standard wired and wireless PC networking technologies, and the MCX-2000 allows both wired and wireless connections at the same time. The unit can also connect to the Internet and an existing computer network, enabling exceptionally flexible configuration of your MusicCAST network. In this section, we'll explain some network basics and give some configuration examples for different purposes. Examine these and see which MusicCAST network is best for you.

NOTE The MCX-2000 incorporates the Easy Setup feature (page 27) that helps you configure the best MusicCAST network for your environment. Since configuring a MusicCAST network requires some knowledge about computer networking, we recommend using Easy Setup for optimum results. When you configure a MusicCAST network for the first time, you need to manually operate the MCX-2000 and clients. For this reason, regardless of where each client is finally to be placed, bring the MCX-2000 and all of its clients together in one place to make these processes easier.

Network Basics

You can easily configure a MusicCAST network using the built-in networking features of the MCX-2000 and clients. The more you learn here about basic networking mechanism and terms, the more you will get out of your MusicCAST systems. Take the time to read this section carefully before configuring your MusicCAST network.

The MCX-2000 finds each client (or each client finds the music server) using a unique address assigned to the companion. This address is called *IP address* and is similar to the physical address of your house. We'll take this analogy a little bit farther and compare the server-client network relationship to the communication between you and your neighbor friend living on the same street.

An IP address is comprised of a *network address* and a *host address*, which are comparable to your street address and home address. The MCX-2000 can only communicate with clients that live on the same street (or have the same network address). Naturally, they are separate entities, and so each has its own unique host address in the same network.

If the MCX-2000 and its clients have a slightly different network address (or, in other words, have a different street, town, city or country name), they are no longer neighbors living on the same street.

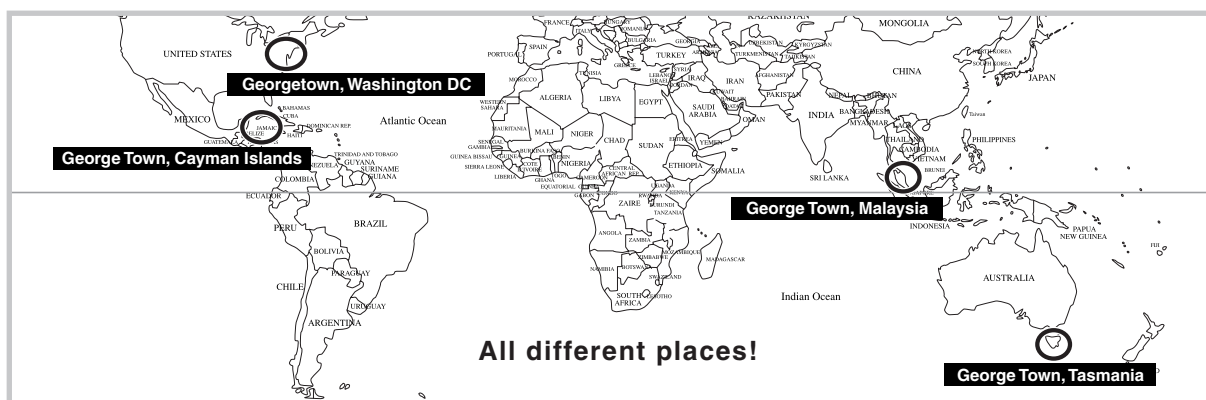

Fortunately, the MCX-2000 and its clients are designed to automatically have the same network address (factory settings). So, the first step of configuring a MusicCAST network is easily cleared. In other words, they are designed to live on the same street. The second step is to determine and assign a unique host address to each of them.

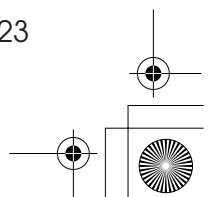
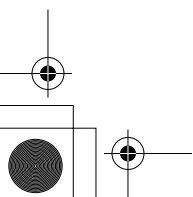

During automatic configuration of a MusicCAST network, the MCX-2000 utilizes a technique called DHCP (Dynamic Host Configuration Protocol) to assign a unique IP address to each client (DHCP server feature) and define where they are in the MusicCAST network. Once the music server and clients have a unique address in the MusicCAST network, they can find each other, and music streaming and other network communication becomes possible.

Configuration of a MusicCAST-only network

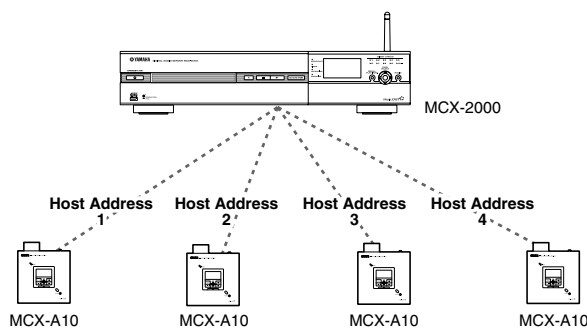

If you want to use the MCX-2000 for listening to music stored on a Windows PC, or if you want to connect the MCX-2000 to the Internet, you need to set the same network address to the Windows PC, the MCX-2000 and its clients. Once you do this, your MusicCAST network becomes integrated into your PC network.

You can easily create this integrated network. If your PC network is already connected to the Internet, simply connect the MCX-2000 to the PC network hub using a standard network cable. In this configuration, the MCX-2000 and its clients are automatically assigned a unique host address from the DHCP server in the PC network. As a result, your Windows PC, the MCX-2000 and its clients all belong to the same LAN.

Configuration of a MusicCAST network for PC network and Internet access

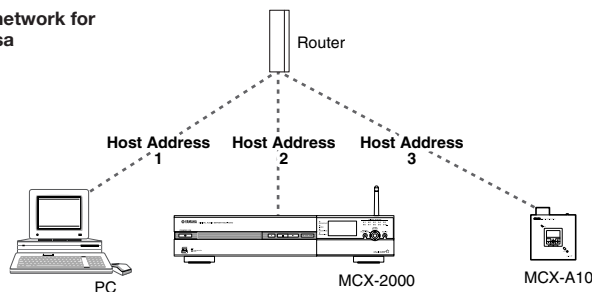

The DHCP server in your PC network might be a dedicated DHCP server (PC running DHCP server software). For most customers, the easiest way to deploy a DHCP service for a personal network is to use an equivalent feature of a commercial router product. (You may already have one for broadband Internet access.) The router is a dedicated device that sends and receives necessary information between networks while limiting unnecessary information or blocking unauthorized access from one network to another. Standard router products also offer a DHCP server feature.

Now perhaps you understand the basics of computer networks. The above two examples are typical (and among the easiest) configurations of your MusicCAST network. Of course, you can create other configurations based on your networking needs. In the following sections, we'll explain how to configure your MusicCAST network based on the above two examples.

NOTE You cannot set up the MCX-2000 (MusicCAST network) to directly connect to the Internet. Always use a router to bridge your MusicCAST network and the Internet.

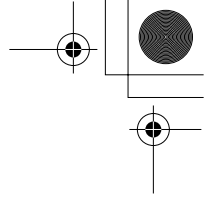

Configuring a MusicCAST-only Network

The simplest and easiest way is to network the MCX-2000 and its clients in a wireless configuration. In a wireless MusicCAST network, the MCX-2000 can stream music to up to five clients within a range of 30 meters from the server. This is ideal for most houses, since the MusicCAST network can extend to any room without using a single network cable. With the wireless setup, you don't need to place the MCX-2000 and clients on the same floor. However, if there is an obstacle that blocks radio signals between the MCX-2000 and clients, music streaming may fail even though the devices are theoretically placed closely enough.

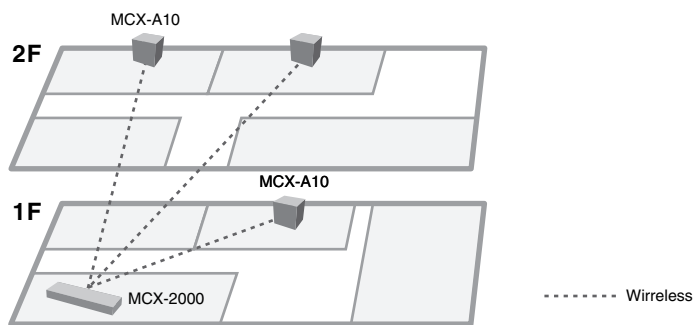

If you are planning to use the MusicCAST systems in a multi-floor shop (for example, in building larger than a family house), you may want to connect more clients using network cables. In addition to the five wireless clients, the MCX-2000 can support up to ten wired clients at the same time. The server can stream a different song to each client, or broadcast the same music to several clients. You can use these functions to create different moods in different rooms by streaming separate music to clients on each floor, all the while broadcasting the same music to maintain a unified image for the shop. You can even use the timer playback feature (page 97) to stream the same audio message to all clients at the specified time while they normally play different music.

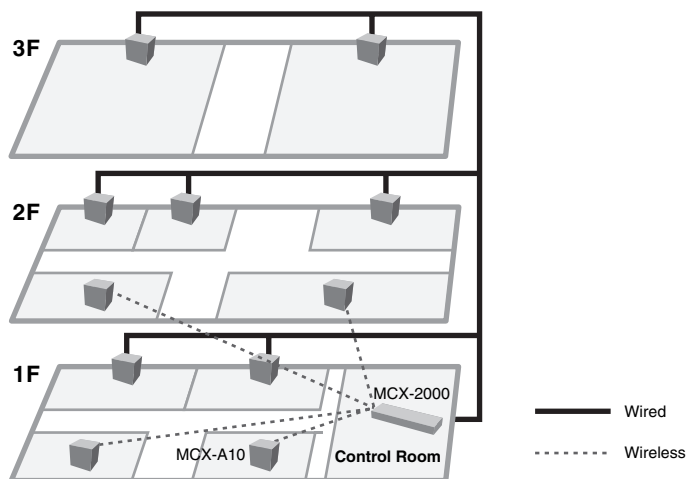

These two MusicCAST networks are easily configured using Easy Setup (page 27).

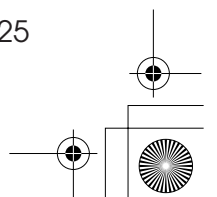
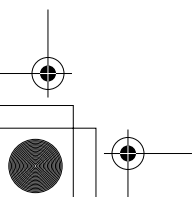

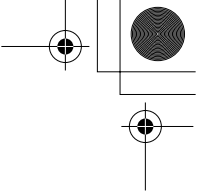

Configuring a MusicCAST Network for PC Network and Internet Access

Recently, many people are enjoying music using their computers. If you're managing a music collection on a Windows PC, you can also listen to songs from the collection on the MCX-2000. To enable this, just start networking between that PC and the MCX-2000 (page 31). If you already have a home network, simply connect the MCX-2000 to that network using a standard network cable. Next, install the supplied software application to the music PC, open the application, and you're ready to go. When you select "Network Content" for audio source on the MCX-2000, the unit automatically locates the music PC in the network and displays a list of songs from the PC music collection. Simply select a song you want to listen from the list, and start playback (page 64). Once the MCX-2000 and PC is networked, you can also edit song data for the music archive on the MCX-2000 using a standard web browser on a computer in the PC network (page 76).

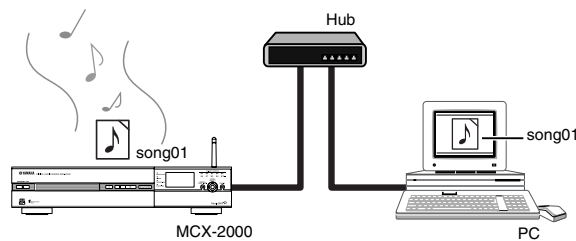

As a computer user, you're maybe using the Internet, or maybe sharing a broadband Internet connection with two or more computers in the same PC network. If this applies to you, we recommend to configure your MusicCAST network so that the MCX-2000 can access the Internet via your PC network (page 31). In this configuration, you can broadcast an Internet radio program to multiple clients (page 59), automatically get the latest song data from the online CDDB database, and regularly set accurate time to the MCX-2000 and clients using a public time server (page 91).

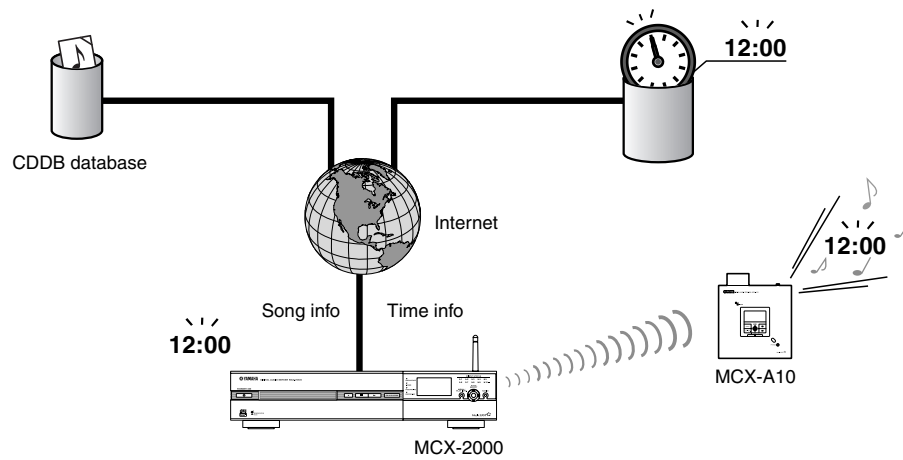

These two MusicCAST networks are easily configured using Easy Setup (page 27).

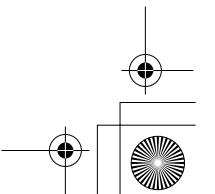
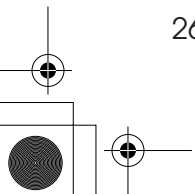

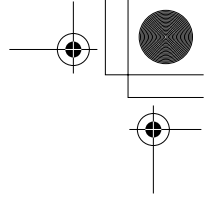

Using Easy Setup

You have many options to set up the MCX-2000 (setting parameters), and they serve as switch or data to make the MCX-2000 the best music server for you. So, you need to understand what each parameter does and set it up appropriately to create your MusicCAST network as purposed. You can manually set up all parameters one by one, but it's so painful. That's why we've prepared the Easy Setup feature as one of menu items. Using Easy Setup, you can set up the MCX-2000 quickly and create a purposed MusicCAST network very easily.

NOTE The front panel display doesn't show the Easy Setup screens. Operate the MCX-2000 watching your TV monitor that's connected to the MCX-2000 video output.

- 1 Press the TOP MENU button on the remote control, and select Top Menu > Setup > Easy Setup.

NOTE Skip this operation when you turn on the MCX-2000 for the first time after purchase, or after the system reset operation (page 103) because the Easy Setup screen will appear instead of the Top Menu screen.

- 2 In the first screen, you're asked to select a language used for menus and messages. Move the selection (highlight) to your desired language and press the SELECT button. (Turn on its radio button.)



- 3 When you go the next screen, you can see notes on Easy Setup. Read notes and, if you're ready, go to the next screen.

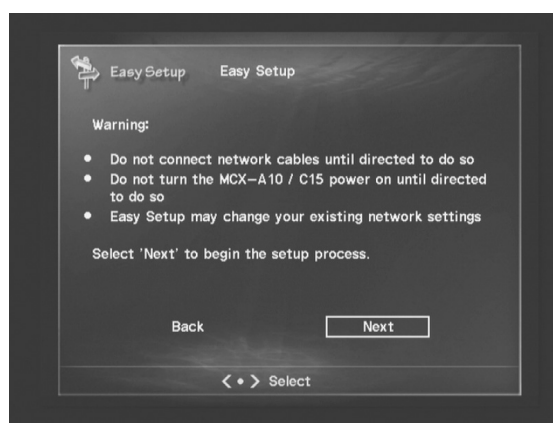

As above, Easy Setup lets you configure the MCX-2000 interactively. Simply continue selecting your preferred option(s) in each screen. And, you'll complete necessary settings for your MusicCAST network. We introduce several Easy Setup screens on the following pages. For details, see the guide messages shown in each Easy Setup screen.

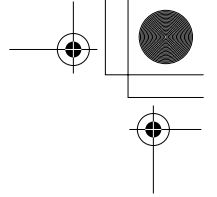

Easy Setup Overview

Date and Time



Move the highlight to a parameter you want to edit, and press the SELECT button. Scroll and display a desired value, and determine it using the SELECT button.

NOTE The MCX-2000 can get an accurate time from a public time server on the Internet (page 91).

MusicCAST System Configuration

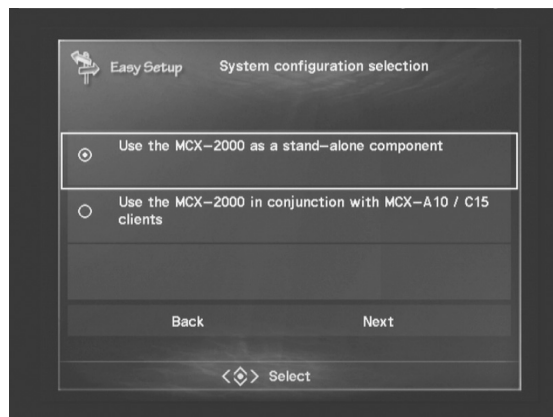

Select from Stand-alone (no MusicCAST network) or Together with Clients (to enable music streaming).

Network Connection (stand-alone, without clients)

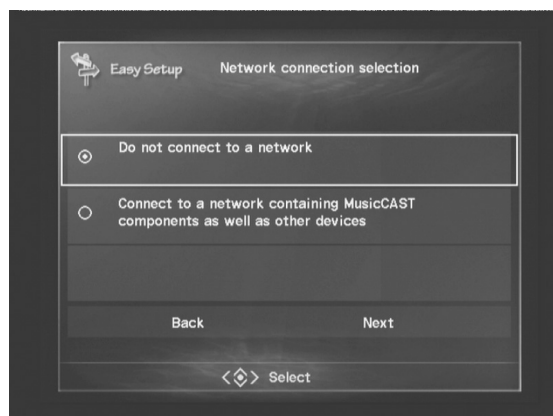

Select from No Connection (no PC or Internet access) or Existing Network (to enable PC or Internet access).

NOTE When using the MCX-2000 solely without clients, PC and Internet, Easy Setup finishes with this screen.

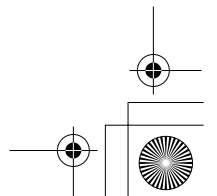
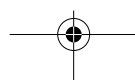
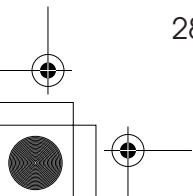

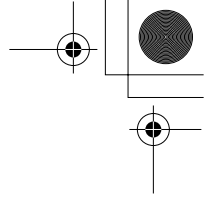

Network Connection (with clients)

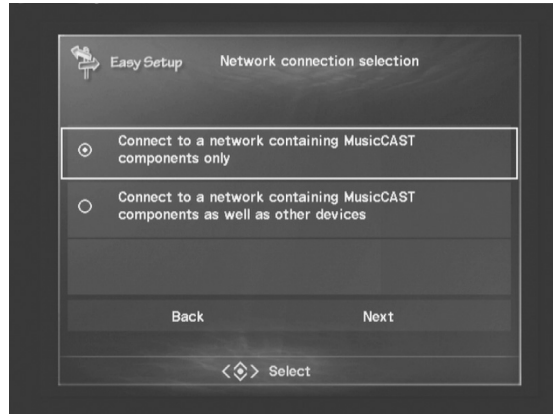

Select from MusicCAST Only (no PC or Internet access) or PC Network Integration (to enable PC or Internet access).

Network Configuration

Available network configuration options may vary according to your selections.

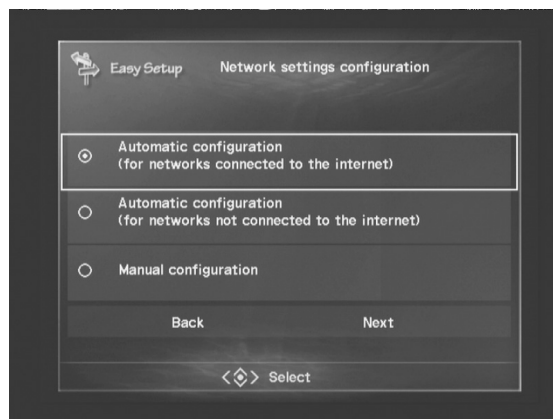

Select from Automatic (with Internet access), Automatic (without Internet access) or Manual. It's recommended to select one of the Automatic settings (depending on your need) if you're unfamiliar with networking.

NOTE If you select Manual, Easy Setup finishes with this screen. You need to set up your MCX-2000 and MusicCAST network parameters manually. See "Manual Configuration of a MusicCAST Network" (page 35) for details.

While you answer these questions, Easy Setup determines network configurations you need. Unless you select to manually configure network parameters, Easy Setup finally shows a diagram of required physical network connections. (Your diagram may be different from the following ones.)

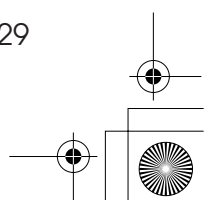
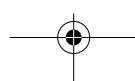
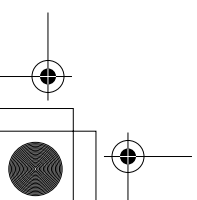

For the MCX-2000 to access the Internet via an existing PC network

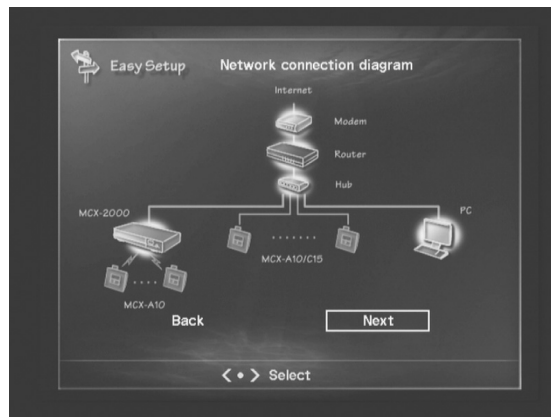

According to the diagram, connect the MCX-2000 Ethernet port to the network hub (or the one equipped with your router) using a standard network cable (CAT5 straight cable). Also, connect all wired clients (using a network cable for each) to the network hub connected to the MCX-2000.

NOTE When you have specified to use the MCX-2000 as a stand-alone unit with PC or Internet access, Easy Setup finishes after setting up network parameters.

For automatic configuration of a MusicCAST network

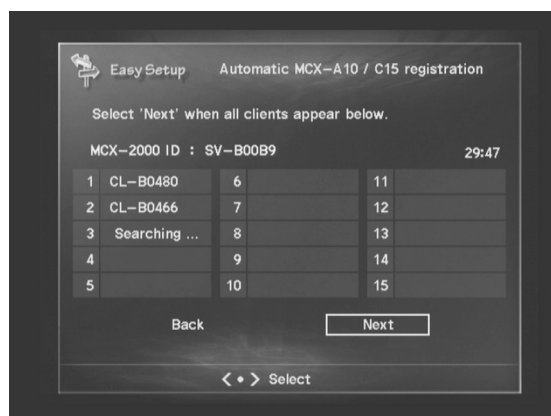

Consecutively, Easy Setup lets you register clients (page 32) and update their firmware (page 45). Easy Setup finishes when these processes are all complete.

Automatic Configuration of a MusicCAST Network

Your MusicCAST network is created when you register clients to the MCX-2000. Once this process is complete, the MCX-2000 and clients can quickly resume network connections even after you reconnect their power cable or awake the MCX-2000 from standby mode (page 14).

NOTE This section describes the procedure of Client Registration that's also available as a final step of Easy Setup (page 27). Though we explain here the procedure starting from the menu item selection, the registration process is identical. So, read this section as supplemental information when using Easy Setup.

Configuration examples:

MusicCAST-only network (without Internet access)

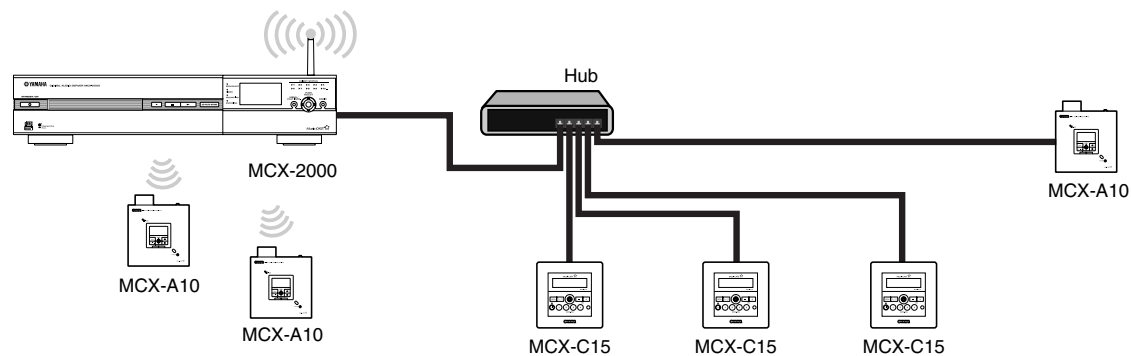

MusicCAST network integrated into a PC network (with Internet access)

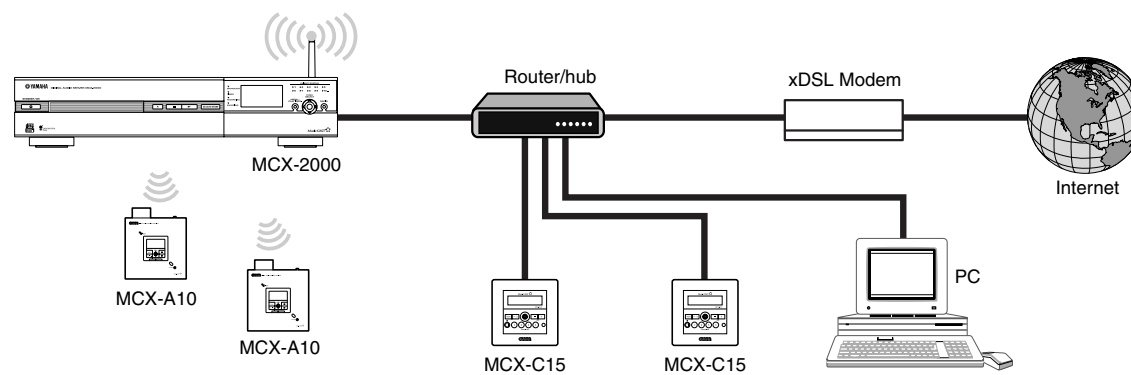

NOTE When you configure a MusicCAST network for the first time, you need to manually operate the MCX-2000 and clients. For this reason, regardless of where each client is finally to be placed, bring the MCX-2000 and all of its clients together in one place to make these processes easier.

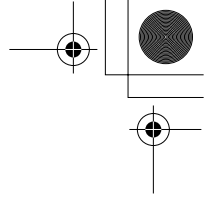

Preparation on the MCX-2000

- 1 Select Top Menu > Setup > Network.



- 2 From the Network menu, select Client Registration > Auto Configuration.

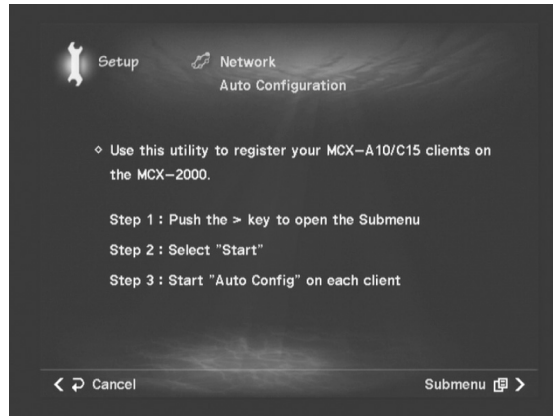

- 3 Open the Submenu in the Auto Configuration screen. Select Start from the menu.

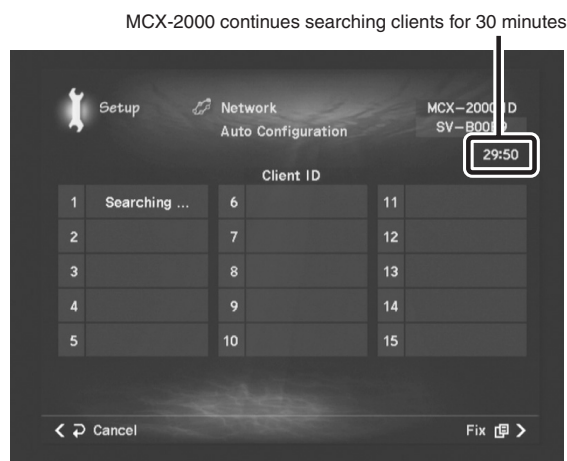

When the MCX-2000 starts searching available clients, register them within 30 minutes. With this screen shown on the MCX-2000, go and prepare each client.

NOTE When you see the "Cannot confirm IP address" message in the screen, there is no external DHCP server that assigns IP addresses to the MCX-2000 and MusicCAST clients. In this case, the MCX-2000 automatically enters DHCP Server mode (page 37). Simply select OK in the dialog box to continue auto configuration. Select Cancel if you want to set up an external DHCP server. Auto Configuration is canceled.

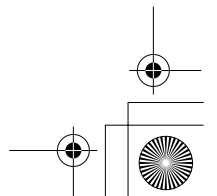
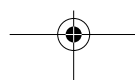
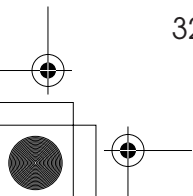

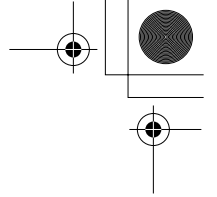

Preparation on Each Client

- 1 Turn on the client.

The front panel display lights up, showing the initial screen, followed by a "Connecting..." message.

NOTE If the client display shows the current time without backlight, it's in sleep mode. If this is the case, press the center stick of the cursor controller. The client wakes up and shows the above message.

- 2 The "Connecting..." message indicates the client is searching a MusicCAST server to establish a network connection. At this point, however, we have not completed any network configuration. So, when the client display shows a network icon, push the controller stick upward or downward to cancel the message. The client stops searching.

wireless network icon (no signal)



wired network icon (disconnected)



NOTE The wireless network icon doesn't appear on the MCX-C15 that supports only wired networking.

- 3 From Top Menu, select Setup > Network > Manual Setup > DHCP. Make sure the DHCP is enabled (ON).

DHCP ON is selected (factory setting)



- 4 Push the controller stick leftward twice to go back to the Network screen. Select Auto Configuration (Top Menu > Setup > Network > Auto Configuration).

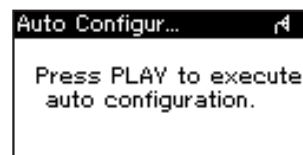

With this screen shown on each client, you can start automatic configuration of a MusicCAST network.

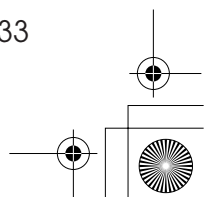
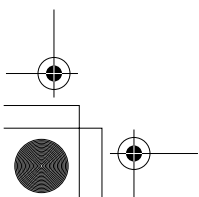

Automatic Registration of Clients

Before configuring a MusicCAST network through automatic Client Registration, be sure to connect any wired clients to the network hub connected to the MCX-2000. (If you want to integrate your MusicCAST network into an existing PC network, connect both the MCX-2000 and wired clients to the PC network hub.)

- 1 On each client, press the front panel Play button as the Auto Configuration screen is shown. Notice the client display shows the following messages in a short period.

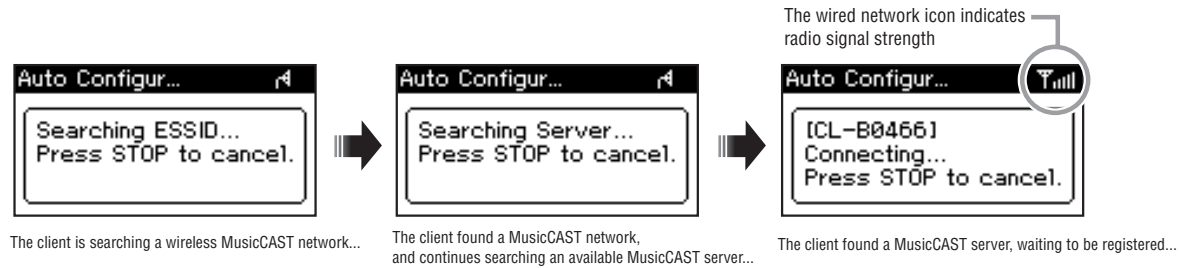

- 2 As soon as the client display shows its ID (CL-XXXXX: a 5-digit unique number to each client), the MCX-2000 will also show the same client ID in the registration screen.

Clients (ID) found in the process

Client ID	
1	CL-B0466
2	Searching ...
3	
4	
5	

MCX-2000 ID: SV-B00B9
28:02

Cancel Fix

NOTE Each client display continues showing "Press STOP to cancel" during the registration process. If you press the Stop button, the registration process for that client will be canceled. Normally, you don't need to operate clients after you pressed the Play button in step 2.

- 3 When the MCX-2000 found all clients, open the Submenu (Fix) in the registration screen. Select OK from the menu. The MCX-2000 shows "Saving..." and registers the clients it found. Each client display shows "Complete!" for a second.

Now that the MCX-2000 and each client recognized and memorized each other, your MusicCAST network is successfully created. Go to Applications section (page 46) and enjoy MusicCAST.

NOTE When networked with the MCX-2000 for the first time, your clients must be updated before actual use (page 45).

Manual Configuration of a MusicCAST Network

There may be a case you need to assign a fixed IP address to the MCX-2000 and clients to integrate a MusicCAST network into a PC network that has no DHCP server. You can solve it by manually configure some or all of network parameters of the MCX-2000 and clients. We explain here several points you should remember when configuring a MusicCAST network manually.

Configuration example:

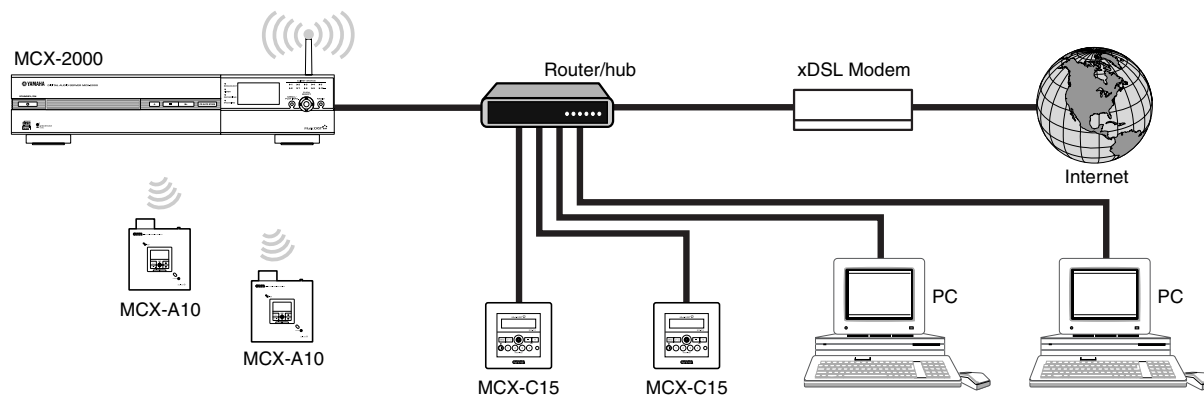

NOTE Though the MCX-2000 has two physical network ports (wired and wireless), these ports internally share a single (identical) IP address. So, you cannot use these ports for two separate network connections. In addition, the MCX-2000 doesn't support music streaming to a remote client over the router (Internet). Always use the MCX-2000, its clients and a PC that's used to communicate with the MCX-2000 within the same network (LAN).

Checking Out Parameter Values

Before manually setting up the MCX-2000 and clients, check out the following values for MusicCAST and PC network integration:

- IP addresses (unique values, not used with other devices in the PC network)
- Subnet mask (the same value as used with other devices in the PC network)
- Gateway (router IP address; essential to connect the MCX-2000 to the Internet)
- DNS server (name server IP address; at least one DNS server is necessary to specify an NTP server (page 91) with its domain name for retrieving accurate time for the MCX-2000 date and time settings)

Network parameter values shown above are very important for successful networking. You must consider how your MusicCAST network is configured for your specific need, and define each parameter value to set up your network as purposed. It's recommended to write down your network plan with appropriate values in the following chart.

System Unique Information	Server/Client ID	MCX-2000	Client (1)	Client (2)	Client (3)	Client (4)
		SV-_____	CL-_____	CL-_____	CL-_____	CL-_____
Network Settings	Setting Method	DHCP Server / DHCP Client / Manual (Specify a valid IP address below with Manual.)	DHCP Client / Manual (Specify a valid IP address below with Manual.)	DHCP Client / Manual (Specify a valid IP address below with Manual.)	DHCP Client / Manual (Specify a valid IP address below with Manual.)	DHCP Client / Manual (Specify a valid IP address below with Manual.)
	IP Address (when DHCP is disabled)
	Subnet Mask
	Gateway Address
	Primary DNS	. . .	—	—	—	—
	Secondary DNS	. . .	—	—	—	—
	NTP Server (only when used) (Server domain name when DNS is specified; Server IP address when DNS is not specified.)	. . .	—	—	—	—
Wireless LAN	ESS ID (up to 13 ASCII characters)					
	WEP Key (up to 13 ASCII characters)					
	Channel		—	—	—	—

NOTE If you have more than 4 clients, copy the blank chart above and substitute the appropriate client numbers as needed.

Settings on the MCX-2000

- 1 Select Top Menu > Setup > Network > Advanced Settings.

Advanced Settings menu



- 2 From the above menu, select IP Address or Wireless LAN as needed, and set up the relevant parameters shown in the screen.

NOTE If you reconfigure your MusicCAST network because you have changed the target PC network configurations, you may want to clear existing MCX-2000 network settings using the Network Settings Reset command from the above menu (page 100).

IP Address

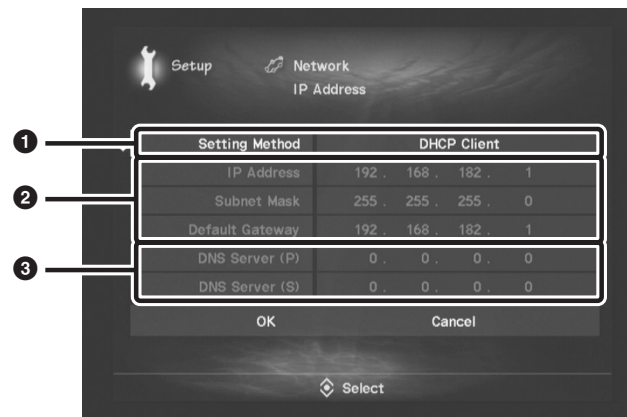

1 Setting Method

Specifies a DHCP operation of the MCX-2000. When the MCX-2000 has a 'wired' connection to a PC network and finds a DHCP server there, it enters DHCP Client mode and gets an IP address from the server. (Accordingly, clients will also get an IP address from the same server.) If the MCX-2000 finds no DHCP server in the connected network, it automatically enters DHCP Server mode. (Clients will get an IP address from the MCX-2000.) Because of this scheme, you normally don't need to change this setting as long as you want to automatically configure a series of network parameters. Select Manual if you really need them to set up manually.

NOTE When you select Manual, you must assign each of the MCX-2000 and clients a unique IP address conforming to the connected PC network (page 23).

2 IP Address, Subnet Mask, Default Gateway

When selecting DHCP Server or Manual for Setting Method, specify an IP address within the network address of the connected PC network. Among these three parameters, only IP Address takes a 'unique' value to the MCX-2000. Subnet Mask and Default Gateway should take the same values with a PC that's manually configured to access the Internet via the connected network. Default Gateway normally takes an IP address set to the router LAN port (supposing the router WAN port is connected to a broadband modem).

3 DNS Server (P), DNS Server (S)

When selecting DHCP Server or Manual for Setting Method, specify IP addresses of primary (P) and secondary (S) DNS servers provided from your Internet service provider. These values (at least one) are necessary if you use URL to specify an Internet resource (server) available to the MCX-2000, such as a public NTP server to get accurate date and time (page 91). If you specify such a resource using the IP address, you can leave these values blank.

When you complete necessary settings, select OK at the bottom of the screen. When the "Network rebooting..." message is shown and your settings are stored, you will return to the Advanced Settings menu.

Wireless LAN

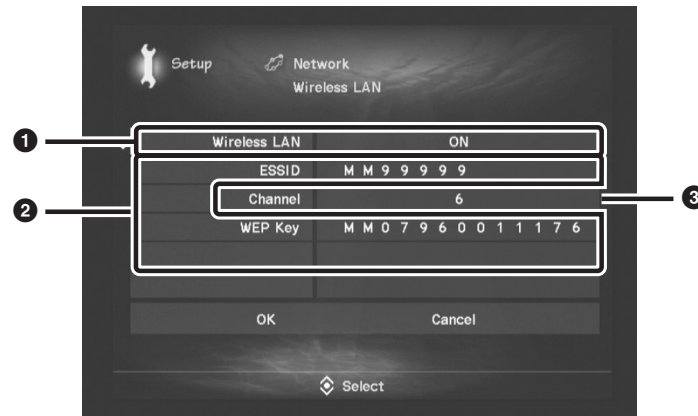

1 Wireless LAN

If you use the wireless functions in your MusicCAST network (or you have a client wirelessly communicating with the MCX-2000), specify ON to enable the wireless access point feature built into the MCX-2000.

2 ESS ID, WEP Key

ESS ID is a name of the wireless network configured by the MCX-2000 wireless access point feature, and WEP Key is a password for clients to log onto the network. If you're using a wireless access point for PC networking, MusicCAST clients only connect to the wireless access point created by MusicCAST servers including the MCX-2000. Since each MusicCAST server is preconfigured with unique ESS ID and WEP Key values, you normally don't need to change them.

NOTE The MCX-2000 supports a 104-bit WEP key (precisely, a 128-bit long key with initialization data), which is equivalent to 13 ASCII characters. If your 'password' is less than 13 characters, the MCX-2000 will internally complement it. In addition, the MCX-2000 doesn't support hexadecimal WEP keys.

3 Channel

The Channel parameter is used to avoid radio interference between the MCX-2000 and a device that uses the same 2.4 GHz radio signal range (such as microwave oven, wireless handset, or other wireless access point). You don't need to change the Channel value unless you're experiencing a problem such as interrupted playback of streamed music or unstable wireless networking.

When you complete necessary settings, select OK at the bottom of the screen. When the "Network rebooting..." message is shown and your settings are stored, you will return to the Advanced Settings menu.

NOTE If you want to access the MCX-2000 from a wireless computer to edit names or titles (page 76), install a wireless access point in your PC network. The wireless access point feature built into the MCX-2000 is available only for MusicCAST clients registered to the MCX-2000 (through automatic or manual configuration).

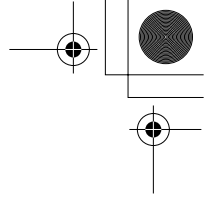

Settings on Each Client

- 1 Turn on the client.

The front panel display lights up, showing the initial screen, followed by a "Connecting..." message.

NOTE If the client display shows the current time without backlight, it's in sleep mode. If this is the case, press the center stick of the cursor controller. The client wakes up and shows the above message.

- 2 The "Connecting..." message indicates the client is searching a MusicCAST server to establish a network connection. At this point, however, we have not completed any network configuration. So, when the client display shows a network icon, push the controller stick upward or downward to cancel the message. The client stops searching.

Wireless network icon (no signal)



Wired network icon (no connection)



NOTE The wireless network icon doesn't appear on the MCX-C15 that supports only wired networking.

- 3 From Top Menu, select Setup > Network > Manual Setup.

Manual Setup menu



From the above menu, select a parameter and set it up as needed.

NOTE You may perhaps choose manual configuration of network parameters just because you want to get on top of your MusicCAST network. It's, however, not so practical with MusicCAST clients. They're designed to get appropriate parameter values during automatic registration process (page 31), so manual configuration should be done to 'edit' retrieved settings according to your special needs.

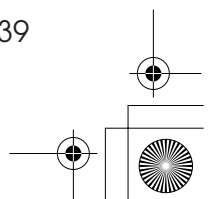
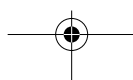
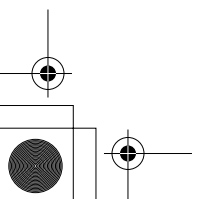

Mode

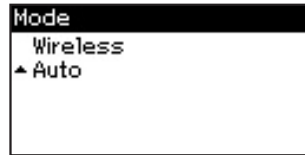

Specify how this client can connect to a MusicCAST network. With Wireless, its wireless network port is only enabled, disabling its wired (Ethernet) network port. With Auto, the client connects to the MCX-2000 via either active network port (factory setting). When using the wireless port, the ESS ID and WEP Key parameters should be configured according to the target MCX-2000 server.

When you select and determine a value, the “Press PLAY to system restart, STOP to cancel.” message is shown. If you press the front panel Play button, the client will restart to enable the change. Press the front panel Stop button to abort your change. Push the controller stick leftward to go back to the Manual Setup menu.

NOTE Wired-only clients (MCX-C15) don't have this parameter.

Server ID

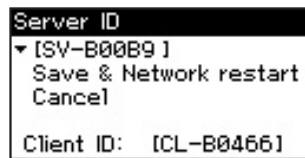

Specify the target MCX-2000 with its ID (SV-XXXXX: a 5-digit unique number to each server). You can confirm the MCX-2000 server ID on your TV monitor, by selecting Top Menu > Setup > Network > Client Configuration > Manual Configuration. You can also confirm client IDs in the MCX-2000 screen if you previously performed the automatic registration (page 34). Client IDs will be required later in manual registration process (page 43), so it's recommended to write them down in your setup chart (page 36) at this point.

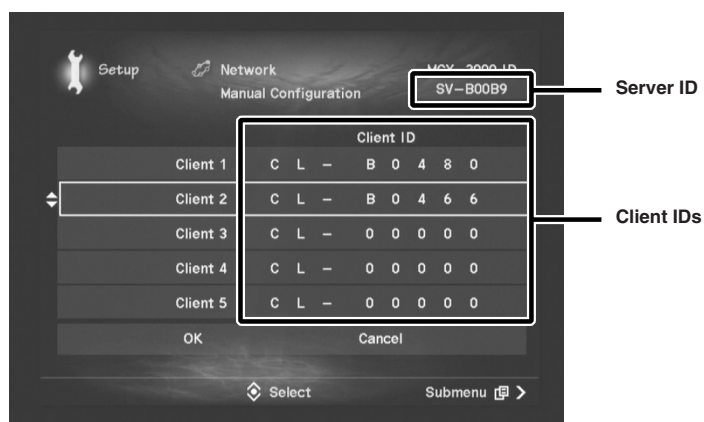

When you have finished, select and determine Save & Network Restart. When the “Please wait.” message is shown and your setting is stored, you will go back to the Manual Setup menu. If you abort your change, select Cancel or push the controller stick leftward.

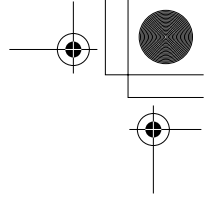

DHCP



Specify ON to automatically get an IP address from the MCX-2000 or a DHCP server (or an equivalent router function) in your PC network (factory setting), or OFF to manually specify on this client. When you select OFF, you need to specify appropriate values to the IP Address and Subnet Mask parameters.

When you select either value, the "Please wait." message is shown. When your setting is stored, you will go back to the Manual Setup menu.

IP Address

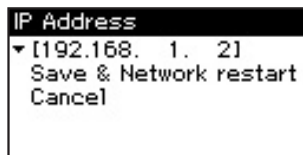

Specify an IP address within the same network address as the target MCX-2000. This value must be unique and shouldn't duplicate the one used for the MCX-2000, other MusicCAST clients or devices in the target PC network. The specified IP address only works when the DHCP parameter is set to OFF (when this client doesn't get an IP address from the MCX-2000 or a DHCP server in your PC network).

When you have finished, select and determine Save & Network Restart. When the "Please wait." message is shown and your setting is stored, you will go back to the Manual Setup menu. If you abort your change, select Cancel or push the controller stick leftward.

Subnet Mask

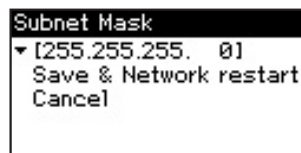

Specify the same subnet mask value as the target MCX-2000. The specified subnet mask value only works when the DHCP parameter is set to OFF (when this client doesn't get an IP address from the MCX-2000 or a DHCP server in your PC network).

When you have finished, select and determine Save & Network Restart. When the "Please wait." message is shown and your setting is stored, you will go back to the Manual Setup menu. If you abort your change, select Cancel or push the controller stick leftward.

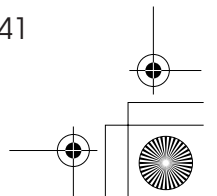
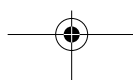
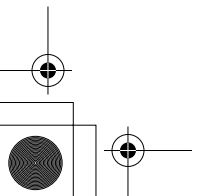

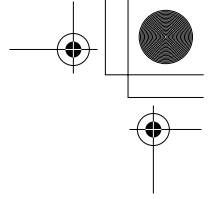

ESS ID

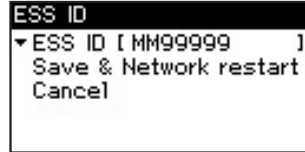

Specify the ESS ID for the wireless network created by the target MCX-2000. You can confirm the MCX-2000 ESS ID, by selecting Top Menu > Setup > Network > Advanced Settings > Wireless LAN.

When you have finished, select and determine Save & Network Restart. When the “Please wait.” message is shown and your setting is stored, you will go back to the Manual Setup menu. If you abort your change, select Cancel or push the controller stick leftward.

NOTE Wired-only clients (MCX-C15) don't have this parameter.

WEP Key

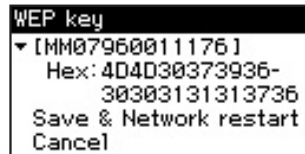

Specify the WEP key for the wireless network created by the target MCX-2000. You can confirm the MCX-2000 WEP key, by selecting Top Menu > Setup > Network > Advanced Settings > Wireless LAN. In addition, you can also view the WEP key in hexadecimal (HEX) in the client display (just for confirmation).

When you have finished, select and determine Save & Network Restart. When the “Please wait.” message is shown and your setting is stored, you will go back to the Manual Setup menu. If you abort your change, select Cancel or push the controller stick leftward.

NOTE Wired-only clients (MCX-C15) don't have this parameter.

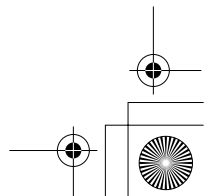
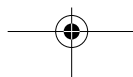
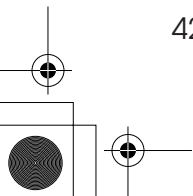

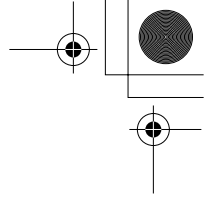

Manual Registration of Clients

Unlike automatic registration (page 34), configuring a MusicCAST network through manual registration is completed with setup on the MCX-2000 only.

- 1 Select Top Menu > Setup > Network.

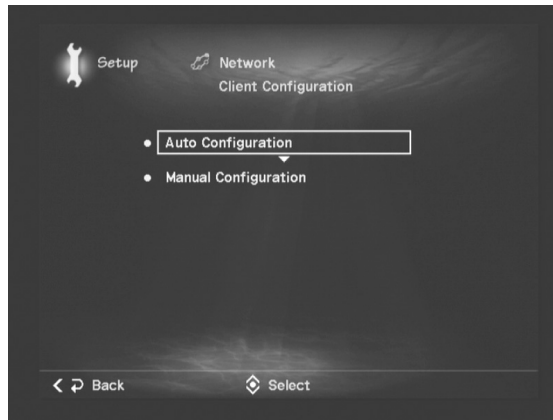

- 2 From the Network menu, select Client Configuration > Manual Configuration.



- 3 Input each client ID to one of the Client 1 to Client 15 columns (up to 15 units), while viewing the setup chart. You can input your client ID to any column. (Client numbers correspond to the front panel CLIENT STATUS indicators.)

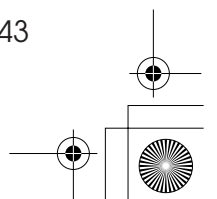
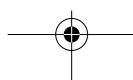
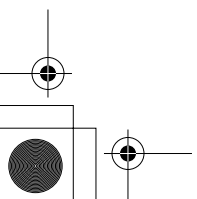
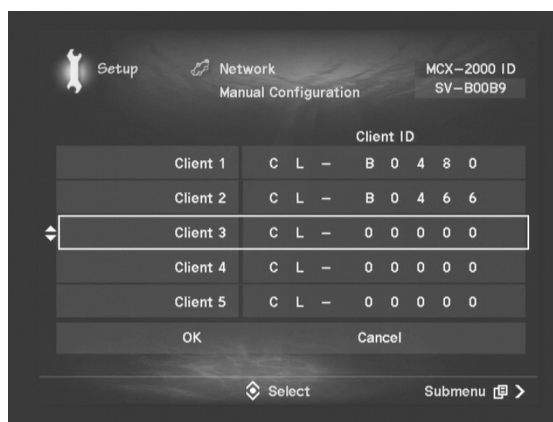

Move the highlight (selection) using the up and down arrow buttons on the cursor controller, press the SELECT button to select a column. Input a 5-digit ID number after "CL-". Use the left and right arrow buttons to move between digits, and the up and down arrow buttons to select a character. When you've finished, press the SELECT button to determine it.

NOTE While you're moving the highlight (not actually editing), you can access the Submenu. The Reset this Client command lets you reset the ID number in the current column to an initial value (CL-00000). The Reset all Clients command lets you clear all clients currently registered to the MCX-2000, resetting all ID numbers at a time. You can also use the Change Client order command to arrange the order of listed clients. Changing the client order resets each client name to the default (Client #). So, be sure if you've renamed them in the Client Control screen (page 87).

4 When you have finished specifying all of your clients, select OK at the bottom of the screen. After showing the "Network rebooting..." message, the MCX-2000 restarts itself attempting to create a MusicCAST network with registered clients. Confirm your manual registration has been successful in the next section.

Confirming Network Status

During and after manual registration, your MusicCAST clients don't show any message like "Complete." in automatic registration. So, you need to confirm they're successfully registered and able to communicate with the MCX-2000 over the network.

- 1** Make sure each registered client is turned on.
- 2** On the MCX-2000, select Top Menu > Client Control for the following screen.

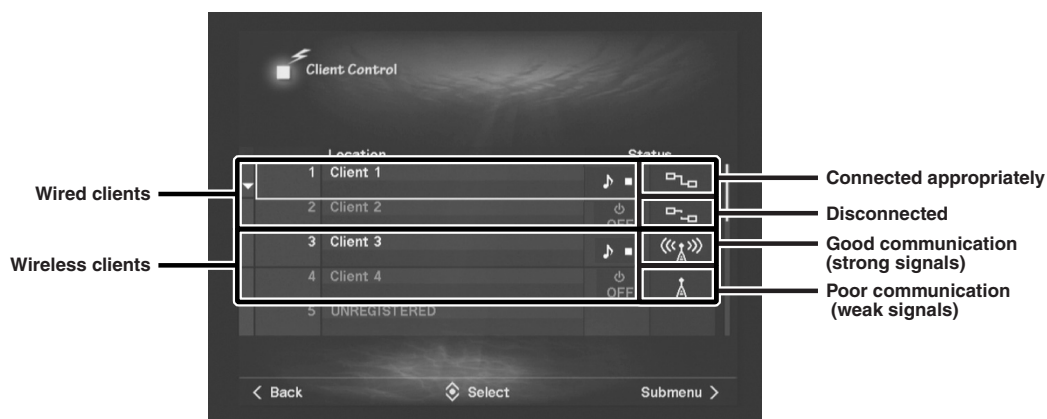

In this screen, you can view the current status of your MusicCAST network (connected clients). When the network icon in the Status column is an appropriate one, the MCX-2000 and that client is well communicating over the MusicCAST network.

NOTE If a wireless client is shown with weak signals, it might be caused by how and where you placed that client. If you start music streaming from the MCX-2000 and experience a problem such as interrupted playback, consider relocating it or connecting to the MCX-2000 using a network cable. If a client is obviously turned on (active), but shown with a 'no signal' wireless icon or a 'disconnected' wired icon, you might have misconfigured. Check the network settings with your setup chart.

When the MCX-2000 and each client are well communicating, your MusicCAST network has successfully been created. Go to Applications section (page 46) and enjoy MusicCAST.

NOTE When networked with the MCX-2000 for the first time, your clients must be updated before actual use (page 45).

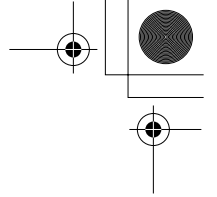

Updating Client Firmware

To fully enjoy music streaming over a MusicCAST network, you must first update all of your MusicCAST clients to match up to the latest features the MCX-2000 delivers. Update each client firmware in the following procedure. (You don't need to operate the MCX-2000.)

NOTE If you already updated the client firmware using Easy Setup, this process isn't necessary.

- 1 Select Top Menu > Setup > System > System Update.

Current firmware version and its creation date

```
System Update
Version: 1.2.2b
Date: 2004/07/06
      19:13:59
Press PLAY to update.
```

- 2 With the above screen shown, press the front panel Play button.

Receiving the latest firmware

```
System Update
Receiving...
```

Your client receives the latest firmware from the MCX-2000, and then updates the content in its flash memory. During the update process, the client display shows several messages. When the "Update OK" message is finally shown, your client restarts itself.

- 3 When the client establishes a network connection with the MCX-2000 and shows the Top Menu screen, the update process is complete. If you're using two or more clients, repeat the above procedure.

NOTE We endeavor to keep our products better. When a future version of the MCX-2000 firmware is available, first update your MCX-2000 with the specified procedure (page 103), and then update your client firmware with the above procedure.

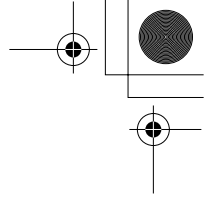

Applications

Once you've finished setting up your MCX-2000 (and MusicCAST clients), you can start using it as a music server. This section explains how you can play and record audio sources on the MCX-2000, and stream music to the clients over the MusicCAST network.

Playing Audio Sources

The MCX-2000 supports playback of five different audio sources, and they are accessible from the Library screen opened from the Top Menu. Select Top Menu > Library for the following screen.



CD

Select this when listening to a CD set in the MCX-2000. Supported CDs are music CDs (CD-DA) and MP3 CDs (CD ROM). Since the MCX-2000 can track the file hierarchy in an MP3 CD (up to eight levels), you can play songs organized in folders or directories.

Inputs

Select this when listening to incoming analog or digital audio signals from an external device. Playback control for these external inputs should be done from the external device.

NOTE The MCX-2000 can play any one of the above audio sources while streaming a different archived song to each client in your MusicCAST network.

Playing Archived Music

To enjoy listening to songs from the music archive, you need to record them beforehand onto the MCX-2000 (page 66). You can add unique data to each song or audio program to easily find it later in the music archive. In fact, the song data gives a great help to categorize or group archived songs.

NOTE Music streaming will start when you select and play (request) a song on each client. While song selection and playback control of streamed music are based on client operations, you can still control each client remotely from the MCX-2000 (page 87).

- 1 Select Top Menu > Library > Music Archive to open the following Music Archive menu screen.

Music Archive menu



Music Archive

Select this when listening to music recorded from sources such as music CDs, radios or external audio signals. When you record these audio sources, the MCX-2000 lets you add information such as song title, artist name, album name and genre to each song (or audio program), allowing you to quickly find the music you want to listen to.

Radio

Select this when listening to a radio broadcast. You can select one of main radio sources at any time: the built-in FM tuner, XM Satellite Radio (US model only) and Internet radio.

Network Content

Select this to receive and play audio content from a Windows PC in the network where the MCX-2000 is connected. The supplied software program must be installed beforehand on that computer (page 64).

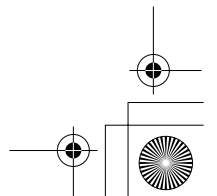
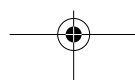
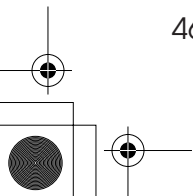

2 From this menu screen, you can select an archived song in a specific category. Try tracking down each category from the menu.

The first four categories (Artists, Albums, Genres and All Songs) let you sift applicable songs out from the music archive. For example, a song titled “Blue in Black” from the “Chelsea” album of a jazz group called “Alley Cats” can be found from any one of the first four categories (menu items).

The other three categories provide additional methods to enjoy more of your music archive. Use the Playlists menu to create and play your own music program, where you can collect archived songs based on your specific theme (such as party songs). Use the Bookmarks menu to view and play a list of songs you have set the bookmark (page 50), or save the current bookmark list as a new playlist. The Statistics menu lets you see or play a list of songs the MCX-2000 automatically collects based on different criteria, such as songs with a large number of play count, songs recently played, albums recently archived, and albums or songs yet to be given appropriate song data.

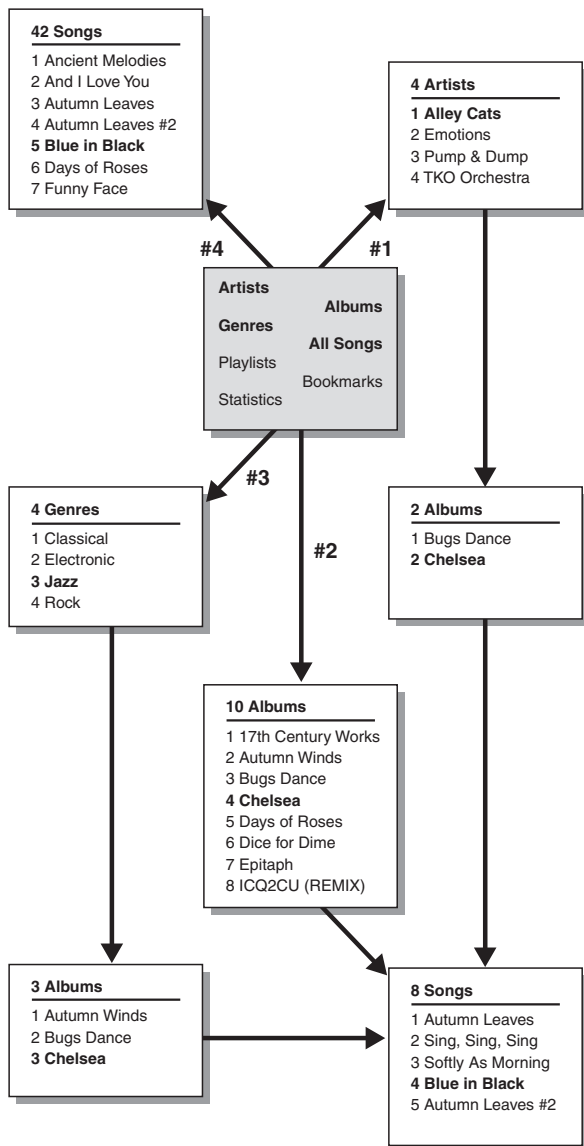

Route #1: Starting from Artists, select Alley Cats from the musician list, next select Chelsea from the album list, and then select Blue in Black from the song list.

Route #2: Starting from Albums, select Chelsea from the album list, and then select Blue in Black from the song list.

Route #3: Starting from Genres, select Jazz from the genre list, next select Chelsea from the album list, and then select Blue in Black from the song list.

Route #4: Starting from All Songs, select Blue in Black from the song list.

- 3** Move the selection (highlight) to a list item from each screen (artist, album, genre, playlist or statistic information). If you press the Play button on the remote control or the MCX-2000 front panel, you can start playback with the first song in the current group. Otherwise, press the SELECT button on the remote control for further sifting.

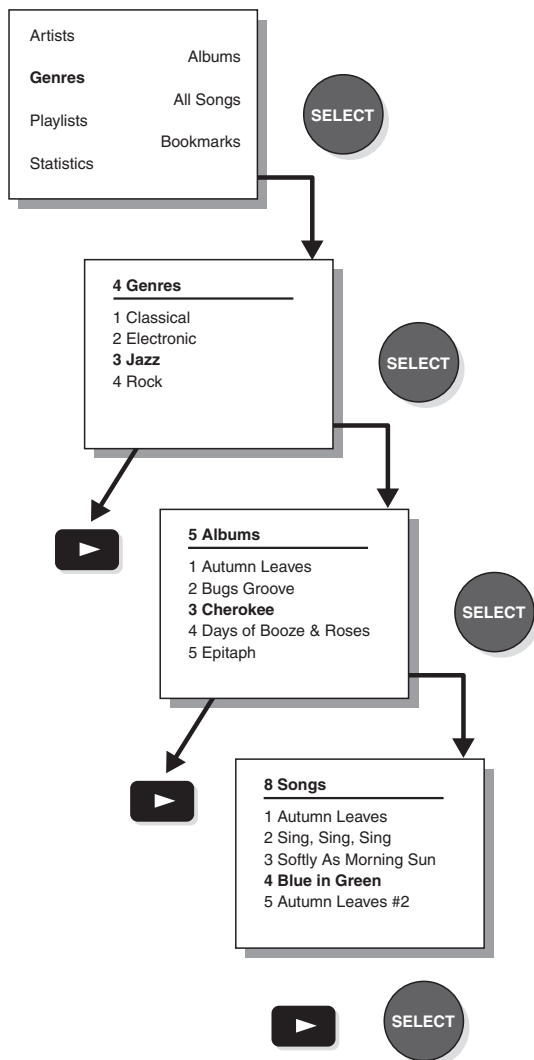

NOTE You can immediately start playback by pressing the Play button on the remote control or the MCX-2000 front panel, or by selecting the Play command from the Submenu in each screen. Use playback control buttons on the remote control to pause, resume or stop playback, or play the current song forward or backward, or skip forward to the next song or backward to the previous song. Similar playback controls are available from the Submenu in the Play Information screen (page 50).

Using the List View

Selecting a List Item

When a certain group in the music archive is listed, names or titles of artists, albums or songs (list items) are sorted in alphabetical order. You may easily find a target artist or song as long as you have a small number of songs in your music archive. But, as your archive grows, it may become more difficult to find a target item. You can solve this problem by using the PAGE scroll buttons on the remote control.

PAGE Scroll Buttons

If you select Artists for the search category, you will see a list of artists whose songs are stored in your music archive. Since a total count of artists is shown in the list header (in sky blue), you can expect how many screens you must scroll through to see the entire list.



In the above screen, you know there are 13 artists in the list so you can see all their names by scrolling down the list once. (The monitor screen shows up to ten list items at a time.) Every time you press a PAGE scroll button, you can see the next or previous ten items in the list. If you press the down arrow button at the last item, the list 'wraps around' back to the first item of the list. Oppositely, you can quickly wrap around to the last item by pressing the up arrow button at the first item of the list. When you find a target artist name in the list, just move the selection (highlight) there, using the up or down arrow buttons on the cursor controller.

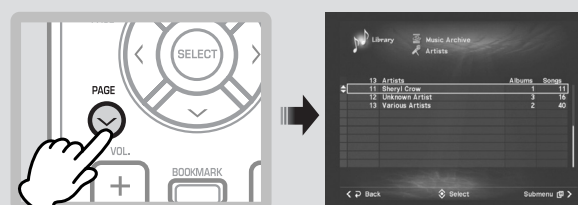

The PAGE scroll buttons work with any list view, regardless of whether the list is sorted in alphabetical order or not. In addition to searching in a list from your music archive, you can also use the PAGE scroll buttons to easily search in a long song list from a music CD or an MP3 CD.

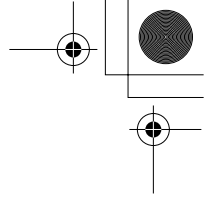

Alphabetical index search Buttons

Unlike the PAGE scroll buttons, the Alphabetical index search buttons only work with lists that sort items in alphabetical order. If you select All Songs for the search category, you will always have an alphabetical list of all archived songs, and this list may be long enough—spanning across multiple screens, depending on how many songs you have.



NOTE The alphabetical order of the MCX-2000 list view sorts items according to the following order: ASCII-based English first, followed by other Latin languages and Japanese Kana-Kanji characters.

In the above screen, you know there are a total of 196 songs and you must scroll down the list no fewer than 19 times to see all song titles, even if you use the PAGE scroll buttons. If you know a target song's title, however, you can conveniently use two Alphabetical index search buttons to quickly find the song. Use the down arrow button to jump in an A-to-Z direction, or use the up arrow button to jump in a Z-to-A direction, to the first song in each alphabetical index.

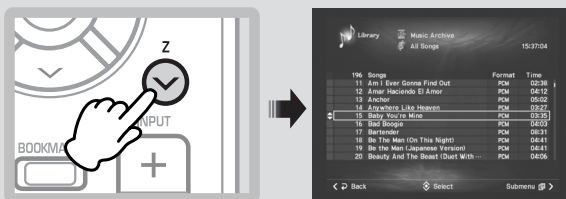

Identifying an List Item

If there are two or more songs (or albums) that have a duplicate name in your music archive, they might be confusing in a list view of All Songs (or Albums). You must play them just for identification? No. Simply use the Information command from the Submenu in each list view screen.



Move the selection (highlight) to your target item, and then select Information from the Submenu. A dialog box appears, showing detailed information of the current item. If it is an album, you can see information including how many song the album contains, who performed the album songs, which genre the album has been categorized into, and when the album has been archived. If the current item is a song, in addition to the album information, you will see the audio format (data format for archiving the song) and how many times it was played.

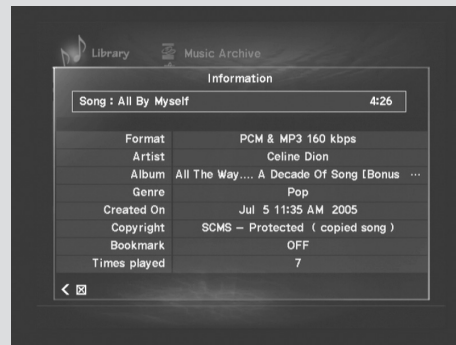

By confirming such detailed information, you can identify each list item even though it has a duplicate name with others. You don't always need to play it just for identification.

You may also encounter a duplicate name if the MCX-2000 couldn't get song data while importing a music CD into the music archive. In this case, the MCX-2000 has given a generic name "Unknown" to the album title, as well as "Track" to each song in the album. As a result, you may have a number of "Unknown" albums and "Track" songs in your music archive. To solve this problem, move the selection (highlight) to a list item with a generic name, and then select CDDB Info from the Submenu. If the CDDB database has been updated since you archived the album, the MCX-2000 will be able to retrieve appropriate song data and update titles of the relevant album and songs.

NOTE For quicker access of CDDB data, the MCX-2000 is designed to keep song data for last 100 music CDs (maximum) retrieved from the online CDDB database. However, you can ignore existing data by retrieving the latest data using the CDDB Info command available from the Submenu in several Music Archive screens.



NOTE Don't worry if you still see generic names after executing the CDDB Info command. The rest of the Submenu commands let you manually edit the title or name of a list item currently selected. But, be careful when using these commands. They can break links in the song data—relationship among song title, album title, artist name and categorized genre—or even delete song audio data itself. See "Editing the Library" (page 75) on how to use these Submenu commands.

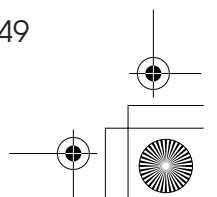
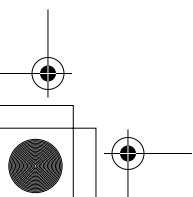

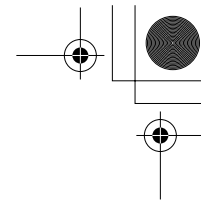

Adding a Bookmark to a Song

Starting from one of the four categories in the Music Archive menu, you can continue sifting and finally reach a song-level list view. Press the BOOKMARK button on the remote control, or select Bookmark from the Tool menu. A sky-blue arrow appears at the left of a song name that's currently selected. It's the bookmark.



You can use the bookmark to mark songs for your specific purpose, such as 'Theme Songs for My Life' or 'Songs for the Next Party' or anything you want. To remove the bookmark, once again move the selection (highlight) to the song and press the BOOKMARK button on the remote control or select Bookmark from the Submenu.

You can see a list of bookmarked songs by selecting Bookmarks from the Music Archive menu.

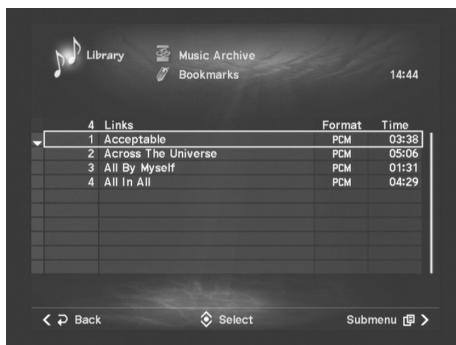

From this list, you can selectively play bookmarked songs. The Submenu commands let you view detailed information for the current song, open its source album, organize the current bookmark list by removing the bookmark from the current song (the current song will disappear from the list), and even save the current list as a new playlist (by naming it as 'Theme Songs for My Life' if you like). In addition, you can arrange the song order by editing the stored playlist.

NOTE Because you can also add or remove the bookmark using the relevant Submenu command in the Play Information screen, you can decide to add or remove it while listening to each archived song.

Play Information and Controls

When you start playback of archived music from a group list (a list view of artists, albums, genres or all songs), a Play Information screen appears. This screen provides the unique song data of the current song, such as the song title, audio format, source album, performing artist and genre, as well as the group from which you started playback. (Song data will be shown in a different order depending on where song playback is started.)

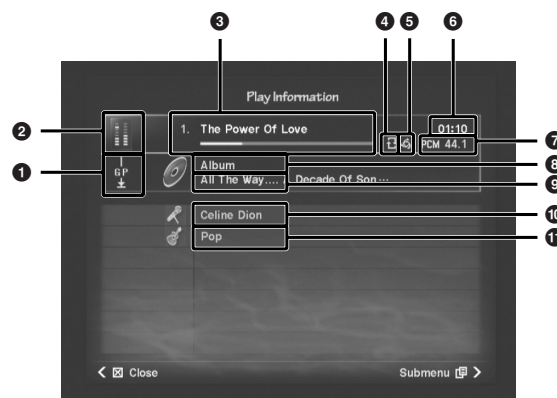

- 1 Playback methods
- 2 Stereo level indicators
- 3 Song title
- 4 Repeat mode
- 5 Random mode (ON)
- 6 Time display
- 7 Audio format
- 8 Category (or audio source) where playback started
- 9 Album title
- 10 Artist name
- 11 Categorized genre

The Submenu commands in the Play Information screen for archived songs:

Playback: Provides the same playback control functions as available on the remote control. So, you can control the song playback simply using the cursor controller on the front panel or from a PS/2 keyboard (only with cursor and enter keys). Group selection buttons (+/-) only work when you can access the next or previous group, such as other albums from the same artist or genre. On-screen group selection buttons turn gray and don't work if you start playback from All Songs.

Repeat: Select the repeat playback mode. Select Single () to repeat a single song from the current group, or All () to repeat all songs from the current group. Select OFF to stop repeat playback.

Random: Turns the random playback mode on or off.

Group: Select Single to play only the current group, or All to play all other groups in the same category.

Time view: Switches the playback time display between elapsed or remaining time.

Bookmark: Adds or removes the bookmark to the current song.

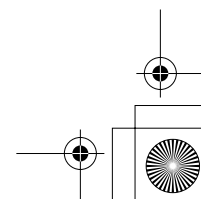
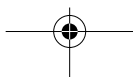
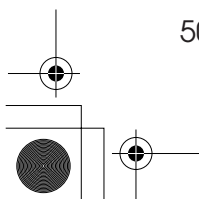

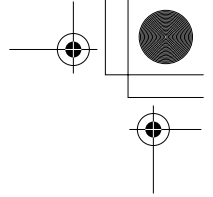

Broadcast: Streams a song currently played on the MCX-2000 to MusicCAST clients specified in a dialog box (page 89).

Recall Play: Makes the MCX-2000 start 'continued' playback of a song currently playing on a client specified in a dialog box (page 90).

NOTE Create and enjoy a wide variety of playback patterns by combining repeat, random and group playback modes. In addition, the Group playback option isn't available in the Submenu if you start playback from All Songs (which is always the same with Group-All selected).

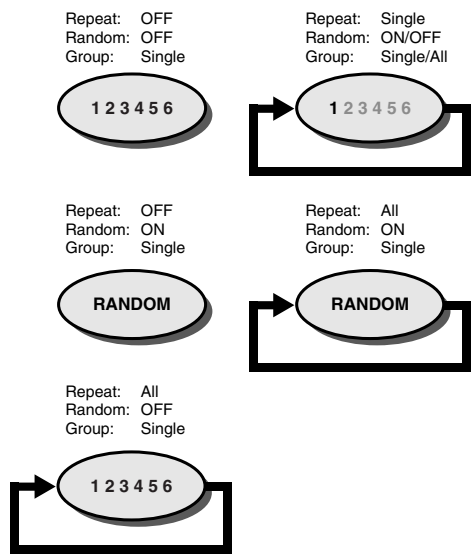

Playing a CD

The CD (compact disc) is one of the most basic and popular media for listening to music. The MCX-2000 even enhances the way you enjoy music from the CD. In addition to simply playing a CD set on the tray, the unit lets you quickly import marked songs to the music archive or start broadcasting any CD song over the MusicCAST network (page 89).

- 1 When listening to a CD, select Top Menu > Library > CD. A song list appears if you've already set a CD in the MCX-2000. If not, your TV monitor will show "No disc present" instead.

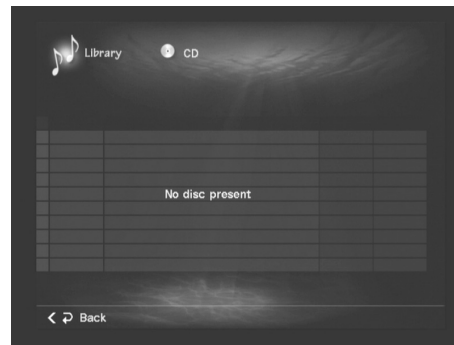

- 2 Press the OPEN/CLOSE button on the remote control and open the CD tray. Set a music CD with its label side facing up. Press the same button again to close the tray.

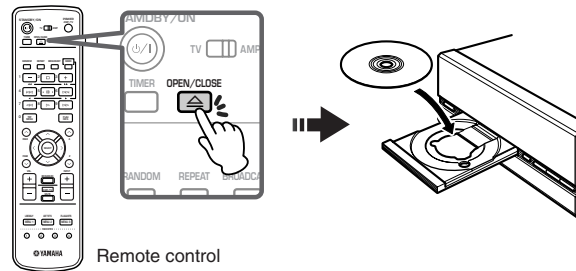

NOTE Supported CD types are music CD (CD-DA) and MP3 CD (CD-ROM). If you set other CD or DVD, the MCX-2000 will show "No Audio CD present" after attempting to read it. For MP3 CDs, see "Notes on Playing an MP3 CD" (page 52).

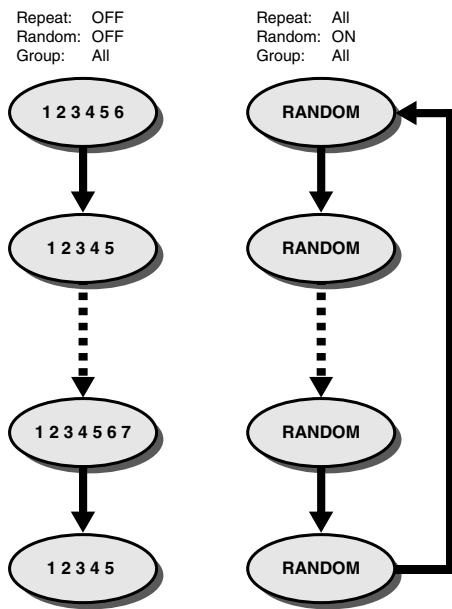

○ = group (artist, album or genre)

NOTE Without the Play Information screen shown, you can still set the repeat or random playback mode, or turn broadcast playback on or off. Press the REPEAT, RANDOM or BROADCAST button on the remote control for a relevant dialog box.

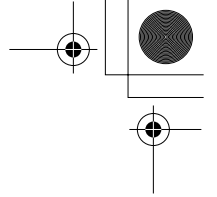

3 When you set a music CD, a “Reading data” message appears in the screen and the MCX-2000 starts querying the CDDB database. (See the CDDB logo animation shown in the upper left corner of the screen.) If appropriate CD data is found, the MCX-2000 will present a CD song list.

4 Move the selection (highlight) to a song you want, and then press the SELECT or Play button on the remote control, or select Play from the Submenu. The Play Information screen appears, starting playback of the current song.



- 1 Album title
- 2 Artist name
- 3 Categorized genre
- 4 Total playback time
- 5 Track count
- 6 Song title
- 7 Audio format (PCM)
- 8 Playback time

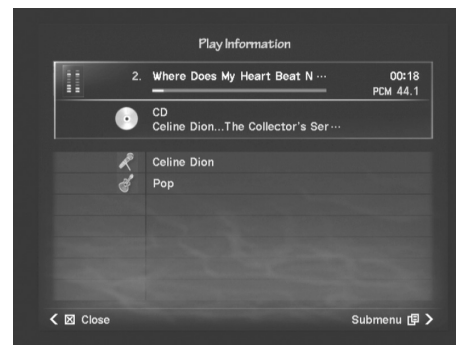

NOTE The Play Information screen for CD provides similar information and Submenu commands for the music archive. See “Play Information and Controls” (page 50).

Notes on Playing an MP3 CD

When you insert an MP3 CD, the MCX-2000 will start checking its directory structure and then show each folder name in a hierarchical view, starting from Root.

The Submenu commands in the song list screen for a music CD:

Play: Starts playback from the currently selected song.

Open REC page: Moves to the “Store from CD” screen (page 66) to import the CD songs to the music archive.

CDDB Info.: Retrieves song data from the built-in or online CDDB database.

CD-TEXT Info.: Displays song data using CD-TEXT information (page 53) stored on the music CD (if available).

Clear CD Info.: Displays song data using generic names. (You can use this when the retrieved song data is incorrect.)

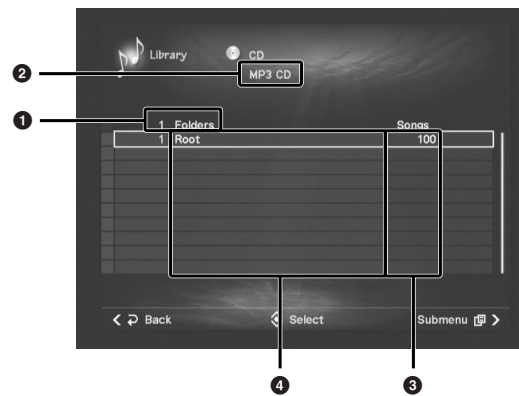

- 1 Folder count (total of folders in the CD)
- 2 Volume name (MP3 CD)
- 3 Song count (total of songs in the folder)
- 4 Folder name

NOTE The MCX-2000 handles each folder in the MP3 CD as a separate album. If your MP3 CD contains 32 folders, think you have 32 albums in the listed order. Ignore each folder’s hierarchical position.

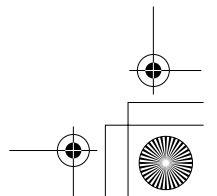
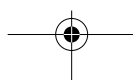
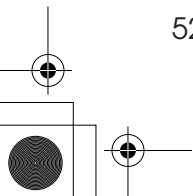

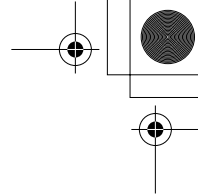

From the folder list view, you can press the Play button on the remote control or select Play from the Submenu to start playback from the first song in the current folder (album). Otherwise, you can press the SELECT button on the cursor controller to open the current folder (album) to see a list of contained songs.



- 1 Volume name (MP3 CD)
- 2 Current folder name
- 3 Song count (total of songs in the current folder)
- 4 Song name
- 5 Audio format (MP3)

Move the selection (highlight) to a song you want, and then press the SELECT or Play button on the remote control, or select Play from the Submenu. The Play Information screen appears, starting playback of the current song.

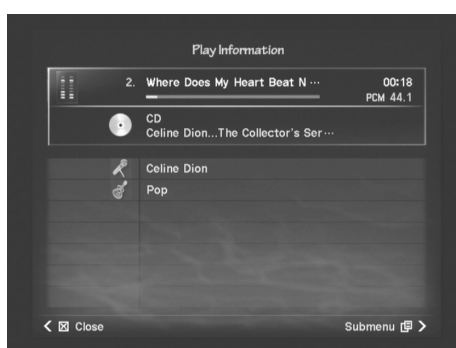

While the Play Information screen is shown, you can skip to the next or previous folder (in the folder list view) by pressing a group selection button (+/-) because each folder is handled as a separate album (group). You can also switch the group playback mode (Single for the current folder; All for all folders). There is one exception: if you start playback from the Root folder, the MCX-2000 behaves as if you start playback of archived songs by selecting Top Menu > Library > All Songs.

NOTE The Play Information screen for CD provides similar information and Submenu commands for the music archive. See "Play Information and Controls" (page 50).

Retrieving Song Data

When you select "CD" for the playback source, the MCX-2000 automatically searches and displays song data such as song title, artist name and album title. Here we introduce this mechanism and relevant keywords.

What is Gracenote CDDB?

Gracenote CDDB is a database system you can use to retrieve information on songs, albums, artists and genres for music CDs. The MCX-2000 incorporates a part of CDDB licensed from Gracenote. The unit attempts to retrieve song data for your music CD from the built-in database. But, since the partial database is limited, there may be cases you cannot retrieve correct song data, especially when your CD has just been released or is one from a private label. If this is the case, you can attempt retrieving the latest or updated song data for your CD from the online CDDB database over the Internet (page 93). Even if it doesn't work, don't be disappointed. You can manually edit any title or name in your music archive (page 75).

NOTE Support for the online CDDB database may be discontinued without prior notice.

What are ID3 Tags?

ID3 tags are various kinds of meta text data that can be embedded into MP3 files. The MCX-2000 supports ID3v1.1, 2.2 though 2.4 tag standards and can display song titles in the list view when you play an MP3 CD. The MCX-2000 supports an MP3 CD that meets the following specifications:

Supported MP3 CD or Songs

Disc format: ISO 9660 level 1 or 2 multisession Juliet/Romeo format (The MCX-2000 doesn't support packet written CDs.)

File hierarchy: Up to eight folder levels; up to 300 files (with an mp3 or MP3 extension)

File format: MPEG-1 Layer 3 standard; all bit rates between 32 to 320 kbps*

ID3 tag version: 1.1, 2.2 through 2.4

(*) The MCX-2000 also supports MP3 songs recorded using Variable Bit Rate (VBR), but may not display the data rate or playback time of such songs correctly.

What is CD-TEXT?

Some music CDs contain text information such as song and album titles, artist names, and genre names. This information is called CD-TEXT. The MCX-2000 can read and display CD-TEXT data, and can import it together with song audio data to the music archive. But, the MCX-2000 doesn't import copy-prohibited CD-TEXT data. In this case, retrieve your CD and song data from the Gracenote CDDB.

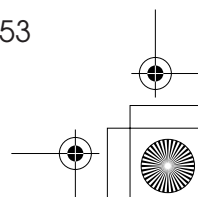
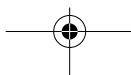
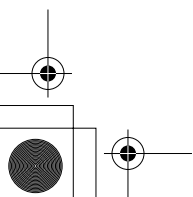
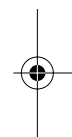

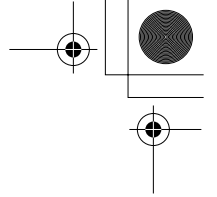

Listening to a Radio Broadcast

Before listening to the radio on the MCX-2000, you need to do some preparation for each radio type—connecting the supplied antenna for the FM radio (page 4), or making the MCX-2000 accessible to the Internet, if you want to listen to Internet radio broadcasts (page 31). In addition, if you're a US resident and want to listen to a radio program from XM Satellite Radio, you also need to connect a third-party XM 'Connect-and-Play' antenna (sold separately) to an MCX-2000 US model and become a subscription member of XM radio (as described in the XM radio section). Once you complete these preparations, you can start listening to a radio broadcast, regardless of where it's from—FM, Internet or XM (US model only).

- 1 Select Top Menu > Library > Radio to open the following Radio menu screen.



FM

Select this for an FM broadcast. Use the Submenu command to directly play the current selection (the last selected FM radio station).

XM (US model only)

Select this for an XM radio program. Use the Submenu command to directly play the current selection (the last selected XM radio station).

Internet Radio

Select this for an Internet radio broadcast. Use the Submenu command to directly play the current selection (the last selected Internet radio station).

Presets

Select this when you want to choose a preset radio station from the list. The MCX-2000 lets you register up to 100 radio stations in 10 groups (up to 10 stations per group). Use the Submenu command to directly play the current selection (the last selected preset radio station).

NOTE You can directly start playing the last selected radio station from FM, Internet Radio or XM (US model only) by pressing the RADIO button on the remote control or on the MCX-2000 front panel. This operation simply switches the playback source on the MCX-2000 to Radio, and doesn't affect playback source on each client (except while the MCX-2000 is broadcasting). Every time you press the RADIO button, the radio type cycles through FM, XM, Internet Radio and Presets with the last selected station for each radio type.

Listening to FM Radio

The FM tuner built into the MCX-2000 provides a set of simple, yet comprehensive functions. You can select a desired FM station in one of two ways: manual tuning and auto scan tuning. Plus, you can even register your favorite FM stations beforehand using the FM Auto Preset feature (page 62), allowing you to directly select a station from the Presets list.

- 1 From the Radio menu screen, select FM. The Play Information screen appears and starts playing the last selected radio station (or just the first FM frequency signals available in your area; no sound if no station is assigned).

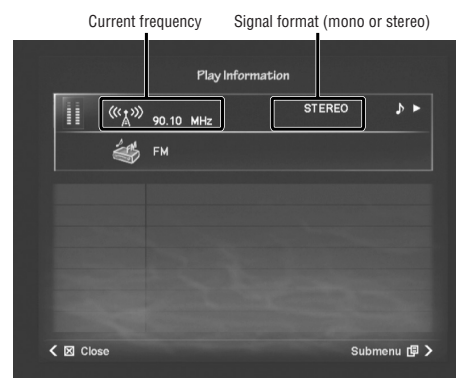

NOTE If you live in Europe and are using an MCX-2000 Europe model, you can enjoy the Radio Data System feature while listening to the FM radio. For details of the MCX-2000 Radio Data System feature, see the following column.

- 2 Use the remote control to tune in to a desired FM station.

When you press either group selection button (-/+), the MCX-2000 starts scanning available stations while decreasing or increasing the frequency; the MCX-2000 automatically stops scanning if a radio station is tuned in; you can also manually stop scanning by pressing either group selection button.

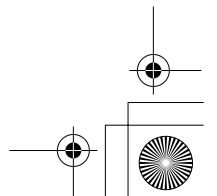
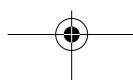
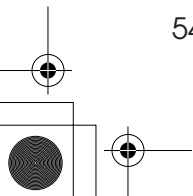
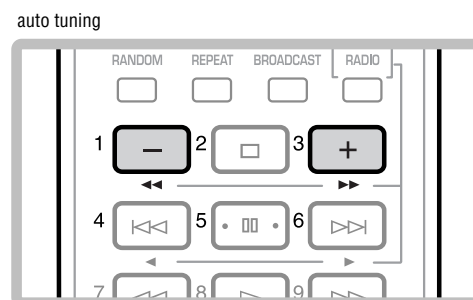

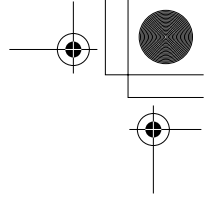

Every time you press the skip backward or forward button (◀◀/▶▶), you can manually decrease or increase the frequency to search for an available station.

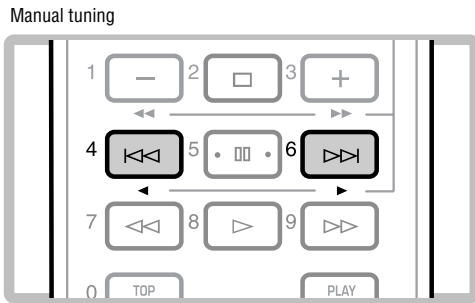

The Submenu commands in the Play Information screen for the FM radio:

Playback: Provides the same tuning and playback control functions as available on the remote control. So, you can control these functions using the cursor controller on the front panel or from a PS/2 keyboard (only with cursor and enter keys). On-screen buttons shown in gray provide no function for the FM radio; the same buttons on the remote control don't work either.

Save to Preset: Registers the current radio station to the Presets list in two steps (page 59).

Broadcast: Streams a radio program currently being received on the MCX-2000 to MusicCAST clients specified in a dialog box (page 89).

Recall Play: Makes the MCX-2000 start 'continued' playback of a song currently played on a client specified in a dialog box (page 90).

Listening to XM Radio (US model only)

The MCX-2000 U.S. model comes standard with an XM Satellite Radio tuner. If you live in the United States and are a subscriber of this paid radio service, you can simply attach a third-party XM Connect-and-Play antenna (sold separately) to your MCX-2000 and start enjoying a wide variety of satellite radio programs.

What is XM Satellite Radio?

XM Satellite Radio is a satellite radio service with millions of listeners across the United States, broadcasting live daily. XM's channel lineup includes more than 150 digital channels of choice from coast to coast: 68 commercial-free music channels, featuring hip hop to opera, classical to country, bluegrass to blues; 33 channels of premier sports, talk, comedy, children's and entertainment programming; and more than 20 channels of traffic and weather information for major metropolitan areas nationwide.

Because XM Satellite Radio is a subscription service, you will need to set up an account and activate service with XM using your XM Satellite Radio ID number. To check your ID number, see the instructions in "Activating Your XM Satellite Radio Account." For further information on XM Satellite Radio services, see the XM Satellite Radio website (www.xmradio.com).

Information from XM Satellite Radio, Inc.

Hardware and required basic monthly subscription sold separately. Premium Channel available at additional monthly cost. Installation costs and other fees and taxes, including a one-time activation fee may apply. Subscription fee is consumer only. All fees and programming subject to change. Subscriptions subject to Customer Agreement available at xmradio.com. Only available in the 48 contiguous United States. © 2005 XM Satellite Radio Inc. All rights reserved. All other trademarks are the property of their respective owners.

Using Radio Data System Information (Europe model only)

Radio Data System is a data transmission system used by FM stations in many European countries. The MCX-2000 can receive Radio Data System data including Program Service Name (PS), Program Type (PTY) and Radio Text (RT) from Radio Data System broadcasts, and provide Play Information for a radio program currently being received.

Receiving a Radio Data System broadcast



- 1 FM station name (program service name)
- 2 Genre (program type)
- 3 Song data (radio text)

Connecting an XM Connect-and-Play Antenna

To receive XM Satellite signals, you will need to use a third-party XM Connect-and-Play antenna. For more information about available XM compatible antenna products, visit the XM Satellite Radio website (www.xmradio.com) or your local XM Ready products dealer. Connect your XM Connect-and-Play antenna to the XM jack on the MCX-2000 back panel. For details, see the instructions provided with your XM Connect-and-Play antenna.

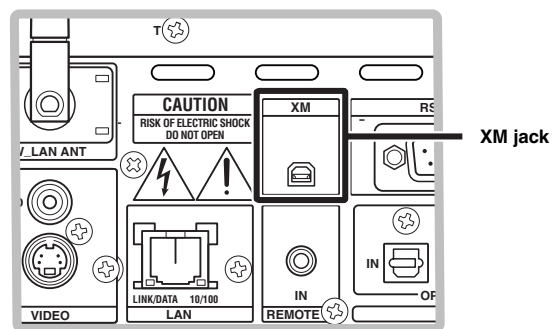

NOTE To ensure optimal reception of XM's satellite signals, your XM Connect-and-Play antenna should be placed at or near a window facing south. Make sure that there is nothing obstructing radio signals from the sky. The antenna may be mounted indoors or outdoors.

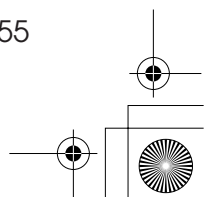
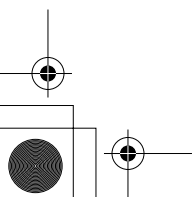

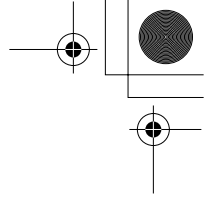

Activating Your XM Satellite Radio Account

To sign up for an XM Satellite Radio service account, you need to have your XM Satellite Radio ID number. Follow the procedure below to check your ID number, and then access the website (activate.xmradio.com) or call 1-800-XM-RADIO (1-800-967-2346) to sign up for the service. (A major credit card is required.)

- 1 Press the RADIO button several times on the remote control or on the MCX-2000 front panel, until the MCX-2000 shows the XM Play Information screen. You can also open this screen from the menu (Top Menu > Library > Radio > XM).

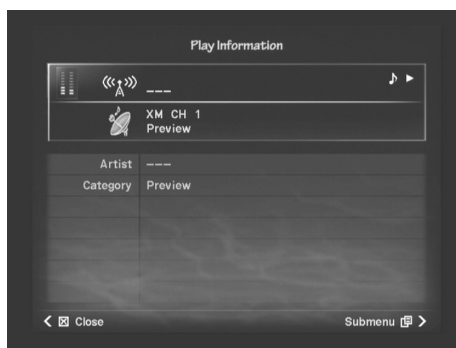

When you first access the XM radio function, Channel 1 is automatically selected.

NOTE If the "CHECK ANTENNA" message appears on the screen, your XM Connect-and-Play antenna may not be connected to the XM jack on the MCX-2000 back panel. Make sure the antenna is properly connected.

- 2 Select Channel 0 using the skip backward or forward button (←/→) on the remote control. Check your XM Satellite Radio ID number shown in the screen and write it down. Now you can activate your XM Satellite Radio account.

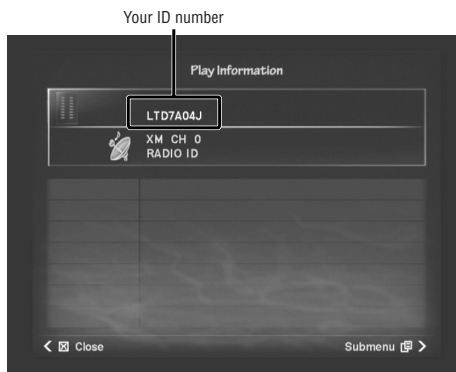

NOTE If you cannot change the channel, first select Search all channels mode (page 57). Then attempt the above steps once again.

Receiving XM Radio Broadcasts

Once you've activated your XM subscriber account, you can start enjoying XM Satellite Radio as another radio source on the MCX-2000. Follow the procedure below.

- 1 From the Radio menu screen (page 54), select XM. The Play Information screen appears and starts playing the radio station last selected. (You may hear no sound if the selected channel has no radio station assigned.) It also shows information of the music currently playing.

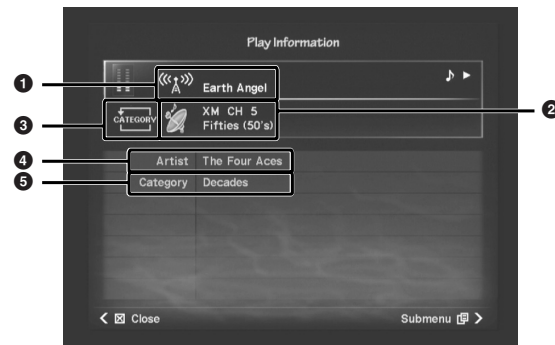

- 1 Song title
- 2 Channel number and radio station name
- 3 Search category mode (icon)
- 4 Artist name
- 5 Category name

- 2 Use the remote control to tune in to a desired radio channel. Press either group selection button (-/+) to select the previous or next category, or press the skip backward or forward button (←/→) to select the previous or next radio channel. You can even select the desired channel specifically using the relevant Submenu commands.

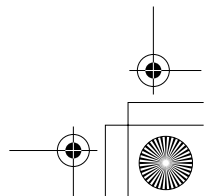
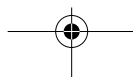
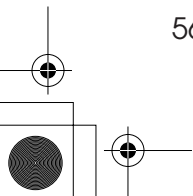

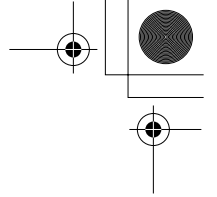

The Submenu commands in the Play Information screen for the XM radio:

Playback: Provides the same tuning and playback control functions as available on the remote control. So, you can control these functions using the cursor controller on the front panel or from a PS/2 keyboard (only with cursor and enter keys). On-screen buttons shown in gray provide no function for XM radio control; the same buttons on the remote control don't work either.

Direct Access: Lets you specify a radio station channel number in a dialog box (page 58).

Search Mode: Switches how you can search a radio station using the skip backward and forward buttons (see the following column).

Save to Preset: Registers the current radio station to the Presets list in two steps (page 59).

Broadcast: Streams a radio program currently being received on the MCX-2000 to MusicCAST clients specified in a dialog box (page 89).

Recall Play: Makes the MCX-2000 start 'continued' playback of a song currently playing on a client specified in a dialog box (page 90).

Channel Search and Direct Access

The MCX-2000 lets you search for the XM radio channel you want to listen to. There are two different search modes you can select from, depending on your preferences. You can also select a desired channel by directly entering the relevant channel number.

From the Submenu in the Play Information screen for XM radio, locate Search Mode and select one of the following options:



Search all channels

With this option selected, you can use the skip backward and forward buttons (◀◀/▶▶) to search for a radio station from all available channels. Pressing either group selection button (-/+) lets you jump to the previous or next category, so that you can skip multiple channels at a time while searching for the desired station.

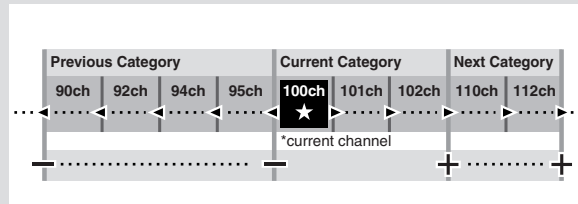

Search category

With this option selected, the Search category mode icon appears in the screen and you can use the skip backward and forward buttons (◀◀/▶▶) to cycle through available channels within the current category. Pressing either group selection button (-/+) lets you jump to the previous or next category, allowing you to perform a cycle search in another category.

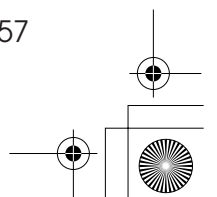
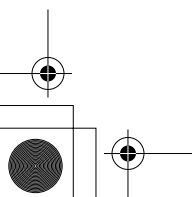
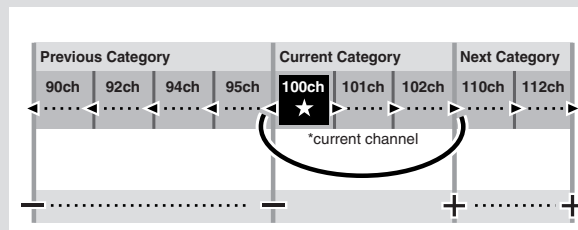

Also in the Submenu, you can select Direct Access if you know the desired channel number.

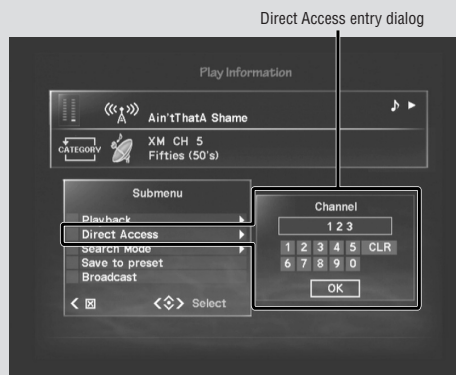

Specify the desired channel number by pressing the on-screen numeric buttons, followed by OK. Press CLR to clear your entry. Wait for a few seconds until the MCX-2000 automatically tunes in to that channel.

NOTE Pressing any buttons other than the numeric buttons cancels Direct Access entry.

Screen Messages for XM Radio

The MCX-2000 may show one of the following messages in the Play Information screen for XM radio. Read each description and handle each situation as recommended.

Message	Description	Action/Solution
CHECK ANTENNA	Your XM Connect-and-Play antenna is not connected, or does not work properly.	Check that your XM Connect-and-Play antenna is properly connected.
UPDATING	The XM user encryption code is being updated.	Wait until the encryption code is completely updated.
NO SIGNAL	The signal is too weak.	Check the XM Connect-and-Play antenna connections and position the antenna for the best reception.
LOADING	The audio or text data decoding process takes longer than four seconds.	Wait until the decoding process is finished.
OFF AIR	The XM Satellite Radio channel you selected is not currently broadcasting any signal.	Check the channel number or select another XM Satellite Radio channel.
CHANNEL - - - - - -	The channel station ID (SID) is no longer available.	Check the channel number or select another XM Satellite Radio channel.
- - -	No artist name/feature or song/program title is available.	Artist name is not sometimes available through a satellite signal for display.
- - -	No channels are available for the selected category.	Category name is not sometimes available through a satellite signal for display.

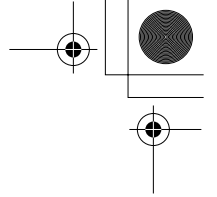

Listening to Internet Radio

In addition to retrieving the latest CD information from the online CDDB database (page 53) and accurate date and time data from a public time server (page 91), the MCX-2000 can also receive online radio broadcasts by accessing to the Internet. Since the MCX-2000 comes with several Internet radio sites preassigned, you can enjoy listening to online radio programs right away once you've set up the unit for Internet access (page 31).

NOTE The MCX-2000 only supports Internet radio stations that stream music and audio in MP3 format.

- 1 From the Radio menu screen (page 54), select Internet Radio. A list of Internet radio sites is shown in the screen.

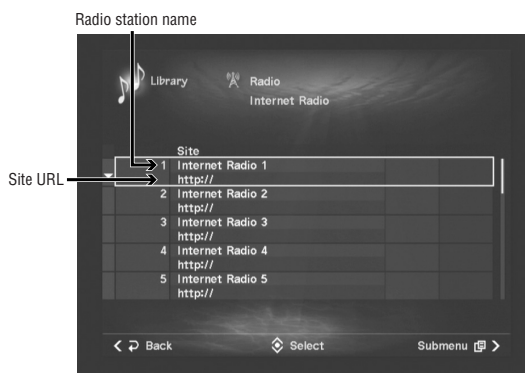

- 2 Move the selection (highlight) to the desired Internet radio station, and then press the SELECT or Play button on the remote control or select the Play command from the Submenu.

NOTE Other Submenu commands, such as Edit Site title, Edit URL and Clear this Site, let you newly register or edit an Internet radio site (page 84).

- 3 The Play Information screen appears. The MCX-2000 accesses the specified Internet radio site and starts receiving its radio stream. Use the skip forward or backward button (⏮/⏭) on the remote control to select the next or previous radio station from the above site list.



The Submenu menu commands in the Play Information screen for the Internet radio:

Playback: Provides the same tuning and playback control functions as available on the remote control. So, you can control these functions using the cursor controller on the front panel or from a PS/2 keyboard (only with cursor and enter keys). On-screen buttons shown in gray provide no function for Internet radio control; the same buttons on the remote control don't work either.

Save to Preset: Registers the current radio station to the Presets list in two steps (page 59).

Broadcast: Streams a radio program currently being received on the MCX-2000 to MusicCAST clients specified in a dialog box (page 89).

Recall Play: Makes the MCX-2000 start 'continued' playback of a song currently playing on a client specified in a dialog box (page 90).

Using the Presets List

The Presets list is where you can store up to 100 radio stations in 10 groups (up to 10 stations per group). Once you've registered your favorite stations in the Play Information screen, you can select and tune in to them right away or manage the list by editing each group and station name. In addition, you can use the Presets list to register available FM stations through an auto scanning process for your own FM Presets list.

NOTE The timer playback feature lets you start playing a specific radio station at a specific time (page 97). If you want to use this feature, first register that radio station in the Presets list.

Registering a Radio Station to the Presets List

Regardless of the radio type, you can register your favorite radio stations to the Presets list directly from each radio's Play Information screen. First, open the Play Information screen with a radio station you want to register, following the procedure explained in each radio section.



NOTE When you want to quickly register a number of FM stations, use the FM Auto Preset command (page 62).

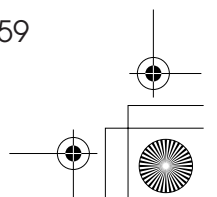
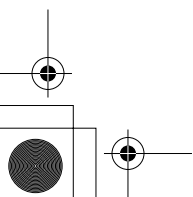

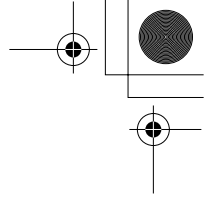

- 1 Select the Save to Preset command from the Submenu. A group selection dialog box appears, where you can assign the current radio station into a specific group.

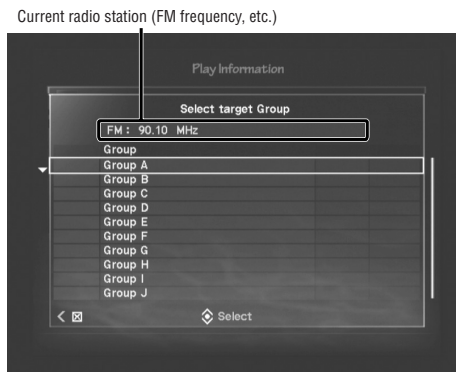

NOTE There are no limitations on which group and position the current radio station should be registered to. You can register radio stations even at random; however, unlike playlist songs, you cannot change the group and position of radio stations after registration. For this reason, you should consider beforehand how to categorize radio stations in the Presets list.

- 3 Move the selection (highlight) to the desired position, and then press the SELECT button on the cursor controller. The selected position flashes several times with a station code. When you return to the Play Information screen, registration is complete.

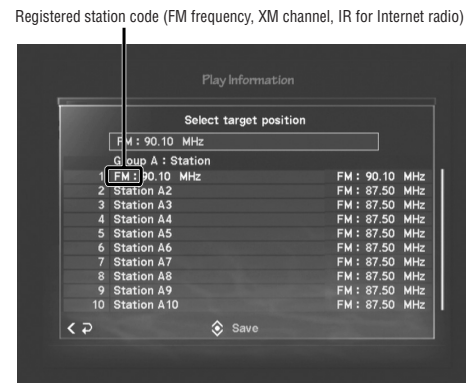

NOTE Any existing station in the selected position is overwritten when you press the SELECT button. You can edit group and station names later in the Presets screen (page 85).

- 2 Move the selection (highlight) to the desired group, and then press the SELECT button on the cursor controller. The second dialog box appears, where you can place the current radio station into the selected group.

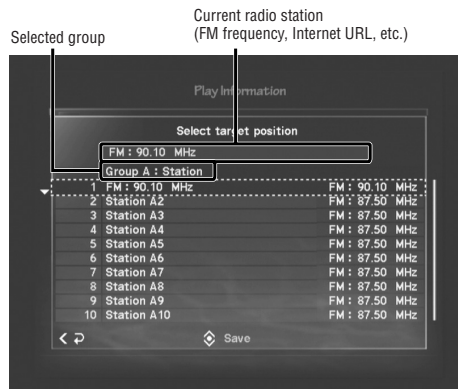

NOTE You can re-select another group if you go back to the previous dialog box, by pressing the left arrow button on the cursor controller. If you cancel the registration, simply press the right arrow button (Quit).

Playing a Radio Station from the Presets List

It's exceptionally easy to select and play a radio station from the Presets list.

- 1 From the Radio menu screen (page 54), select Presets. A list of preset groups is shown in the screen. Move the selection (highlight) to the desired group.

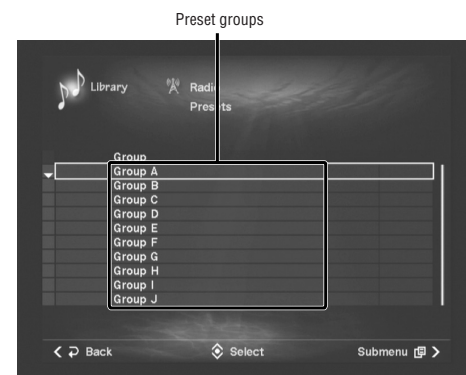

NOTE When you press the Play button on the remote control or select the Play command from the Submenu, the MCX-2000 starts receiving a broadcast from the radio station last selected in the current group. In addition, you can edit group names using the Edit title command (page 85).

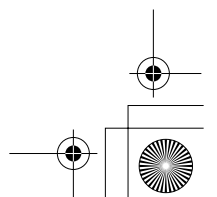
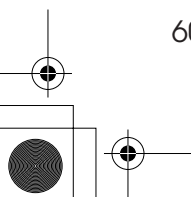

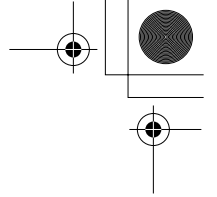

- Press the SELECT button to view a list of radio stations registered in the selected group.

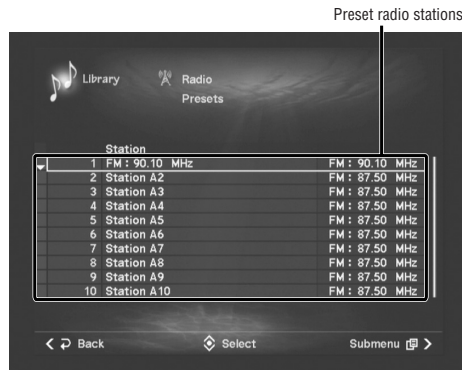

NOTE In this screen, you can create a Presets list of FM radio stations using the FM Auto Preset command from the Submenu (page 62). You can also edit station names using the Edit title command (page 85).

- Move the selection (highlight) to the desired station, and then press the SELECT or Play button on the remote control or select the Play command from the Submenu. The MCX-2000 shows the Play Information screen and starts playing a radio program from the station.

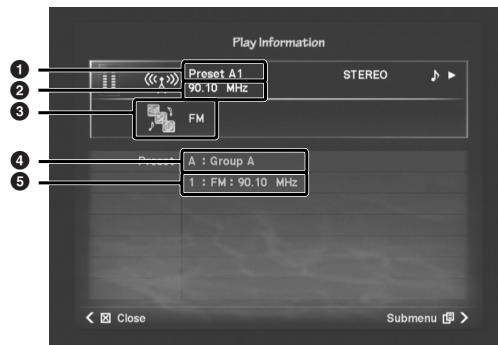

- Preset code (group and position)
- Radio station (FM frequency, etc.)
- Radio type
- Group name
- Station name

The Submenu commands in the Play Information screen for the Preset radio stations:

Playback: Provides the same playback control functions as available on the remote control. Group selection (-/+) and skip backward and forward (◀/▶) buttons can be used to switch radio stations registered in the Presets list (as explained in the following column). On-screen buttons shown in gray provide no function for the currently selected radio station; the same buttons on the remote control don't work either.

Broadcast: Streams a radio program currently being received on the MCX-2000 to MusicCAST clients specified in a dialog box (page 89).

Recall Play: Makes the MCX-2000 start 'continued' playback of a song currently playing on a client specified in a dialog box (page 90).

Getting the most out of the Presets List

Since the MCX-2000 remembers which radio station is last played (selected) at multiple levels—for each group, and for the entire Presets list, you can quickly access radio stations you frequently listen to.

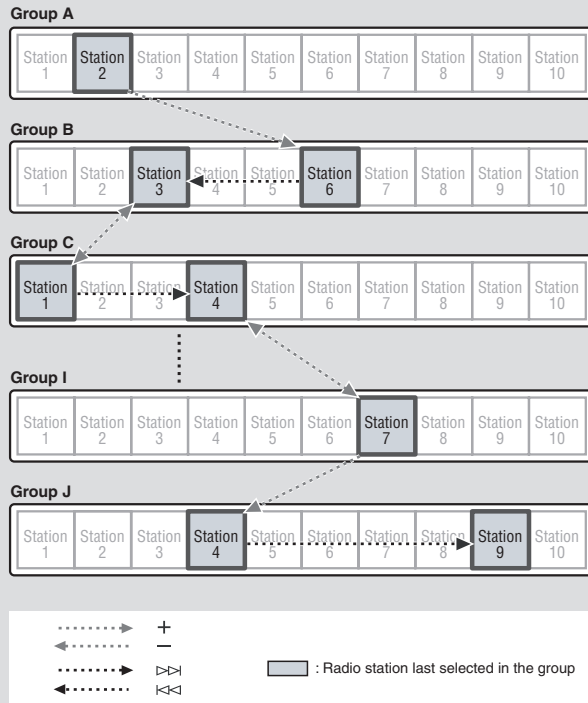

If you use groups (at least) to categorize radio stations with a specific theme (such as genre), you can conveniently switch themes using the group selection buttons (+/-) while selecting radio stations categorized with each theme using the skip backward and forward buttons (◀/▶).

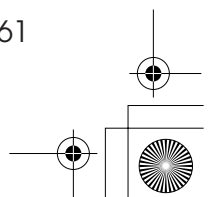
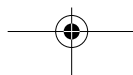
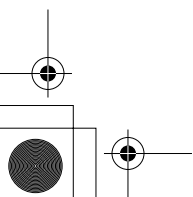

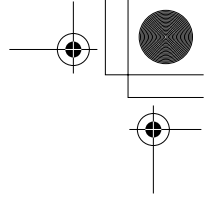

Registering FM Stations Automatically to the Presets List

You can search for an FM radio station in the Play Information screen, which is a basic radio tuning function. In the Preset station list screen, you can use a similar scanning process to locate all available stations within a specific frequency range and register them all in the Presets list—in a single automatic process. This lets you easily create your own FM preset list.

- 1 From the Radio menu screen (page 54), select Presets. Consecutively press the SELECT button on the remote control until you see a list of preset stations in the screen. (You can select any preset group.)

Station list

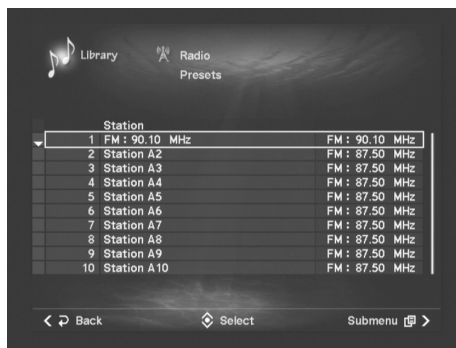

- 2 Select the FM Auto Preset command from the Submenu for the following dialog box.

FM Auto Preset dialog box



- 3 Select and specify the Starting Frequency value where the MCX-2000 starts scanning at, and the Starting Preset position where you want FM stations found in the scanning process to be registered from. Use the up and down arrow buttons (↑/↓) on the cursor controller to change values, as well as the left and right arrow buttons (←/→) to move between group (A~J) and position (1~10).

- 4 Select Start in the dialog box to start automatic scanning and registration of FM stations. The station list of the specified group is shown with “Searching...” at the specified position.



Searching for an FM station to be registered at this position

The progress bar indicates the scanning is ongoing while increasing the frequency. Each station that's found is automatically registered to the current position, and “Searching...” moves to the next position.

NOTE Any existing station in the “Searching...” position is overwritten when a new station is registered. When registration reaches to the last position (J10), the FM Auto Preset process finishes at that point. If you want to cancel the process, press the Stop button or the left arrow button on the cursor controller.

- 5 When “Complete” is shown at the progress bar, the FM Auto Preset process is finished. You will return to the station list screen (the last registered station will be highlighted).



NOTE You can also edit station names using the Edit title command (page 85).

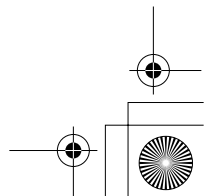
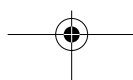
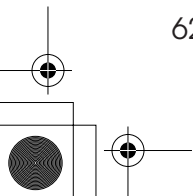

Playing External Audio Signals

As a music server designed to seamlessly integrate all of your audio sources, the MCX-2000 comes standard with analog and digital audio input connectors on the back panel (ANALOG IN and OPTICAL IN). If you have already connected them to the relevant audio output connectors on external equipment (page 9), you can simply select and play external audio signals as another audio source of the MCX-2000. Of course, you can also record them into the music archive (page 69).

- 1 Make sure that audio signals from the external device are set to an appropriate line level, especially when the output level can be controlled from the device (such as a mixer).

NOTE If the external audio signals come from fixed-level output jacks (such as AUX OUT or OPTICAL OUT on a tape deck), this step may not be necessary.

- 2 Select Top Menu > Library > Inputs to open the following menu screen.

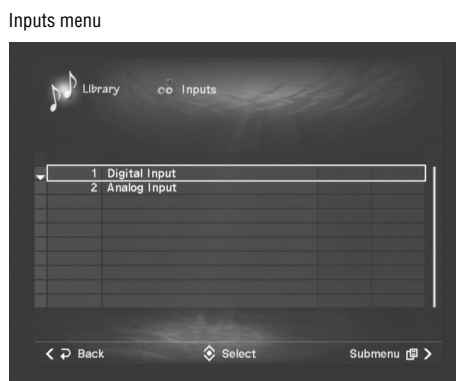

Digital Input

Select this when playing audio signals from the OPTICAL IN jack.

Analog Input

Select this when playing audio signals from the ANALOG IN jacks.

- 3 Move the selection (highlight) to either option, and then press the SELECT or Play button on the remote control, or select the Play command from the Submenu. The Play Information screen for external inputs appears.

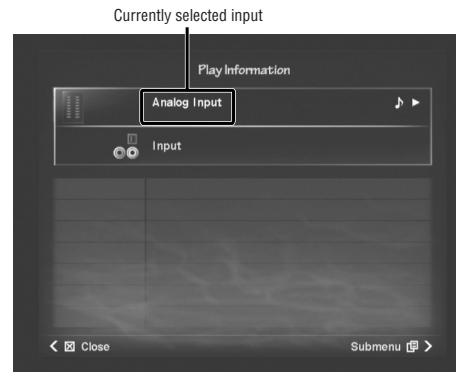

- 4 Start playback on the external output device connected to the currently selected input. For analog signals, you can use the Input Level command to adjust the input level. For optimum results, first adjust the output level from the external device, and then adjust the input level on the MCX-2000.

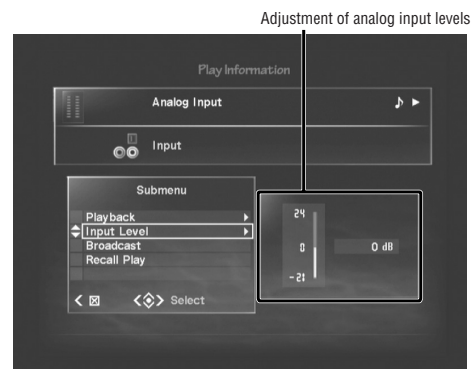

The Submenu commands in the Play Information screen for external audio signals:

Playback: Provides the same playback control functions (Play and Stop) as available on the remote control. On-screen buttons shown in gray provide no function for external audio signals; the same buttons on the remote control don't work either.

Input Level: Adjusts the level for the MCX-2000 to receive external audio signals, within a range between -21 dB and +24 dB (factory setting: 0 dB). The MCX-2000 receives external digital audio signals as they're output from the external device (this command is unavailable.)

Broadcast: Streams external audio signals currently being received on the MCX-2000 to MusicCAST clients specified in a dialog box (page 89).

Recall Play: Makes the MCX-2000 start 'continued' playback of a song currently playing on a client specified in a dialog box (page 90).

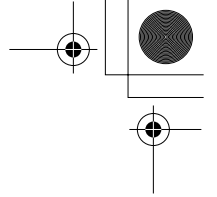

Playing Audio Content on the Computer

If your MCX-2000 has network connectivity to a Windows PC (page 26) that you're using to manage music files, you virtually have a 'second' music server. Your MCX-2000 works as a client to your Windows PC and can search, select and play MP3, WAV and Windows Media Audio (WMA) music files and playlists (text files with the M3U extension) collected or created on that PC over the network. The supplied CD-ROM contains dedicated software named DiXiM™ Media Server for this application.

- 1 Set the supplied CD-ROM to your Windows PC and install the DiXiM Media Server software. You're allowed to install the software to a single computer.

NOTE For PC system requirements and explanation on how to install and use the software, see the supplied manual titled Installation Guide for DiXiM Media Server Software.

- 2 Once your PC is ready to stream music to the MCX-2000, select Top Menu > Library > Network Content for the following screen.

Network Content menu

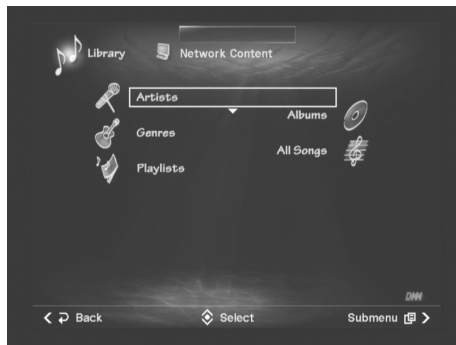

When you attempt to select one of the main categories (Artists, Albums, Genres and All Songs), the MCX-2000 shows a dialog box with a list of available Windows PC(s) running the DiXiM Media Server software, prompting you to select which computer you want to connect as a main PC music server. You can also select the main server (or switch to another DiXiM server) by opening the same dialog box using the Submenu.

NOTE The MCX-2000 remembers the specified main server. If you later change its name (up to 64 characters) within the DiXiM Media Server software, select again the server computer using the above dialog box.

Server selection dialog box

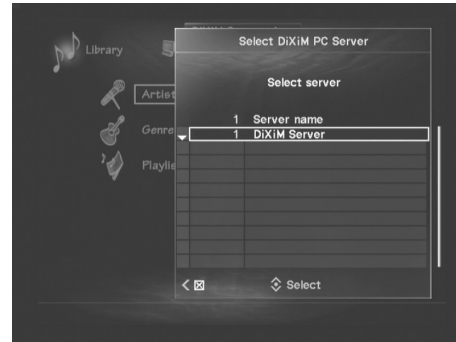

The Network Content menu provides a similar user interface to the Music Archive menu, and lets you select music or audio content from four main categories (Artists, Albums, Genres and All Songs). You can use these categories to sift out your target file(s) in the same manner as you select songs from the Music Archive menu (page 46).

- 3 Move the selection (highlight) to a list item from each screen (artist, album, genre, playlist information). You can start playback with the first song in the current group by pressing the Play button on the remote control or the MCX-2000 front panel or by selecting the Play command from the Submenu in each screen. Otherwise, press the SELECT button on the remote control for further sifting.



NOTE Albums that contain various artists and genres are categorized into the first song's artist or genre. If a song is stored without ID3 tag information, the name of a folder (directory) where that song is placed in becomes the album title for that song. In addition, the MCX-2000 can track the music file hierarchy up to two levels in depth.

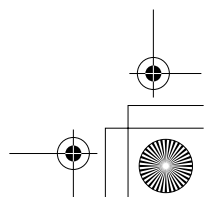
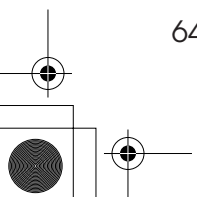

- 4 When you start playback of an MP3, WAV or WMA audio file from the PC, the MCX-2000 shows the Play Information screen as follows.

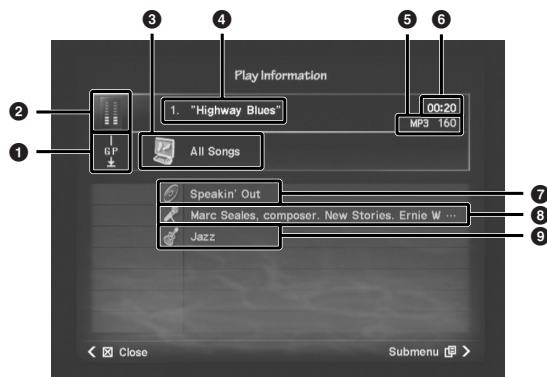

- 1 Playback methods
- 2 Stereo level indicators
- 3 Category where playback started
- 4 Song title
- 5 Audio format
- 6 Time display
- 7 Album title
- 8 Artist name
- 9 Categorized genre



Notes on Playing the Network Content

When using the Network Content feature, you should remember the following:

- **WMA audio files are shown as PCM in the Play Information screen.**
It's because the DiXiM Media Server converts WMA audio into PCM format before it's streamed to the MCX-2000.
- **Network content files cannot be accessed from MusicCAST clients.**
Use the Broadcast feature. The MCX-2000 can broadcast a music or audio file from the DiXiM Media Server to multiple clients, just as broadcasting an Internet radio program.
- **You cannot view digital photo and movie files.**
Though the DiXiM Media Server allows its PC clients to view them over a local network, the MCX-2000 (another DiXiM client) doesn't support a viewing function.
- **The DiXiM Media Server only serves local media files.**
Since the DiXiM Media Server doesn't support 'relaying' network files, you cannot play shared music and audio files from other PCs. (You cannot add folders on a network volume to the server.)

The Submenu commands in the Play Information screen for audio content from a networked PC:

Playback: Provides the same playback control functions as available on the remote control. So, you can control the song playback simply using the cursor controller on the front panel or from a PS/2 keyboard (only with cursor and enter keys). Group selection buttons (+/-) only work when you can access the next or previous group. On-screen group selection buttons turn gray and don't work if you start playback from All Songs.

Repeat: Select the repeat playback mode. Select Single () to repeat a single song from the current group, or All () to repeat all songs from the current group. Select OFF to stop repeat playback.

Random: Turns the random playback mode on or off.

Group: Selects Single to play only the current group, or All to play all other groups in the same category.

Broadcast: Streams a song currently playing on the MCX-2000 to MusicCAST clients specified in a dialog box (page 89).

Recall Play: Makes the MCX-2000 start 'continued' playback of a song currently playing on a client specified in a dialog box (page 90).

NOTE You can create a wide variety of playback patterns by combining repeat, random and group playback modes using the relevant Submenu commands, just like when you play songs from the music archive (page 51). You can also set the repeat or random playback mode, or turn broadcast playback on or off using the relevant remote control buttons (REPEAT, RANDOM and BROADCAST).

Recording Audio Sources

You can expand your music archive by recording (or importing) songs and other audio programs from commercial music CDs, external audio signals, and FM radio programs from the built-in tuner. You can record these audio sources to the MCX-2000 internal hard drive with up to 200 hours in linear PCM format (16-bit/44.1kHz) or up to 2,000 hours in MP3 format (160kbps bit rate) by default. You can adjust recording options (page 96) balancing your preferred sound quality and total recording time. In addition, you can confirm how long recording is possible now in a System Information screen (page 102). When selecting Top Menu > Recording, you will see the following screen.

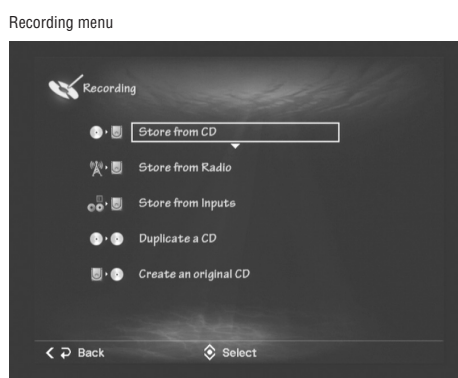

Store from CD

Select this when importing songs from an audio CD (CD-DA). For most commercial music CDs, the MCX-2000 automatically retrieves song data such as artist name, album title and each song title from the CDDb database (page 53).

Store from Radio

Select this when you want to 'air check' an FM radio program. You can adjust the recording level and select recording modes such as Manual and Synchro (Full Auto or Auto Track Marking) for your preferences.

Store from Inputs

Select this when recording incoming audio signals via the MCX-2000 analog or digital input jacks. Using the same recording interface as FM radio recording, you can easily record songs or other audio programs from an old analog tape or other media.

Duplicate a CD

Select this when you want to duplicate an existing audio CD (CD-DA). For duplication, you need a CD-R/RW disc for audio recording.

Create an original CD

This is a special feature that lets you create your original CD from an album or a playlist in your music archive. To get the most out of this feature, you may want to read "Editing the Library" (page 75) after importing necessary songs (or source audio materials) in PCM format.

Recording Songs from a Music CD

In general, music CDs are the easiest and simplest way to create your music archive. Once CD songs are imported, the MCX-2000 lets you manage them using playlists and other editing features (page 75).

- 1 From the Recording menu screen, select Store from CD. A song list will appear if you've already set an audio CD in the MCX-2000. If not, the unit shows "No Audio CD present" along with "Insert Audio CD" in yellow.

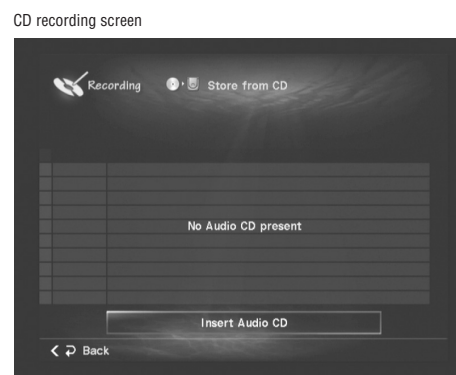

- 2 Press the OPEN/CLOSE button on the remote control and open the CD tray. Set an audio CD with its label side facing up. Press the same button again to close the tray.

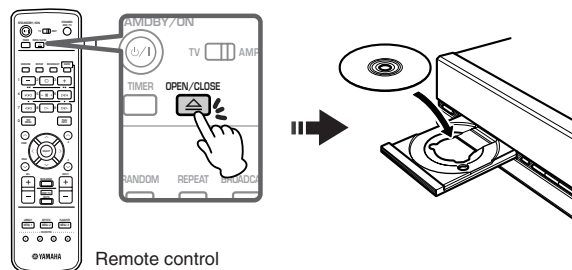

NOTE The MCX-2000 only supports audio CDs (CD-DA) for importing songs. If you set any other CD or DVD, the unit will show "Insert Audio CD" again after attempting to read it.

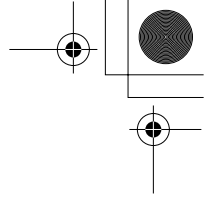

3 The MCX-2000 shows “Checking disc...” in yellow and starts querying to the CDDB database. If appropriate CD data is found, the MCX-2000 will present a list of song names.

4 If there is a song you don't want to import, move the selection (highlight) to that song, and remove the check mark by pressing the SELECT button on the remote control. You can restore the mark by pressing the SELECT button again. You can also use the Select all or Clear command for your selection.



- 1 Album title
- 2 Artist name
- 3 Categorized genre
- 4 Total playback time
- 5 Track count
- 6 Song title
- 7 Playback time



5 After selecting the songs you want to import, select the Start command. You can stop recording at any time by selecting the Stop command.

If appropriate CD data is unavailable, the song list appears with generic names such as “Track” and “Unknown” (page 49). If your MCX-2000 is configured to be able to access the Internet, you can set a CD Lookup option to use the online CDDB database (page 93) and then, in the above screen, try using the CDDB command as shown below to retrieve the latest information from the online database. If your audio CD contains CD-TEXT data (page 53), song data can be retrieved from it using the CD-TEXT command. Feel free to give generic names using the “Do not use” command. Use this if the retrieved song data is incorrect. You can edit it later after importing songs (page 75).



NOTE Song data retrieved from copy-protected CD-TEXT data is only temporary. The MCX-2000 cannot copy and store it for archived songs.

The MCX-2000 shows a progress bar for each of the selected songs.

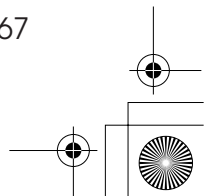
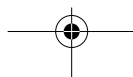
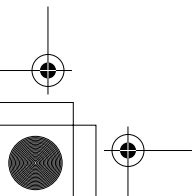

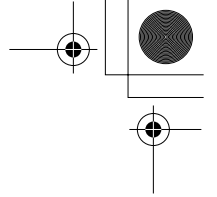

6 When all selected songs are imported, the MCX-2000 shows the following dialog box, asking what you want to do next.

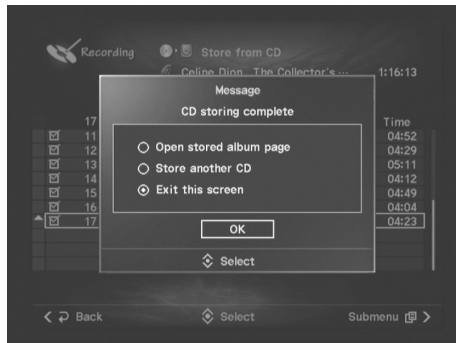

3 When the RECORDING indicator goes off, the MCX-2000 shows the following dialog box, asking what you want to do next.

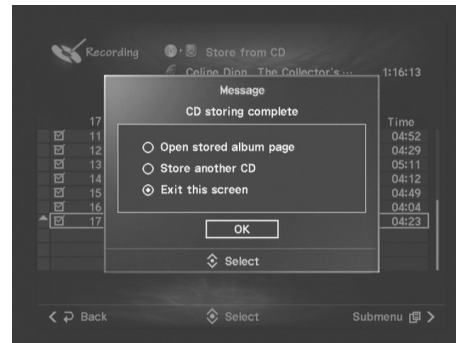

Open stored album page: Select this to automatically locate the album you've just imported. You can browse and play the songs from the album like other archived songs (page 46).

Store another CD: Select this when importing another CD. The MCX-2000 automatically opens the tray and lets you repeat the above procedure from step 1.

Exit this screen: Select this to simply close the dialog box, and perform any other operation you need to manually.

Open stored album page: Select this to automatically locate the album you've just imported. You can browse and play the songs from the album like other archived songs (page 46).

Store another CD: Select this when you import another CD. The MCX-2000 automatically opens the tray and lets you repeat steps 2 to 3 above.

Exit this screen: Select this to simply close the dialog box, and perform any other operation you need to manually.

Importing a Music CD Automatically

If you have a large collection of music CDs and want them all in the MCX-2000 music archive, you may want to skip operating steps required in the CD recording screen in the previous section. This method is just for you.

- 1** Have all the music CDs you want to import ready and close by the MCX-2000. It's important to save time and efficiently import your CDs.
- 2** Use the Open/Close button on the unit's front panel to open the tray; set a music CD on the tray with its label side facing up; press the CD AUTO STORE button on the unit's front panel (the tray closes by itself). After showing a list of CD songs for a few seconds, the MCX-2000 starts importing all songs on the CD.

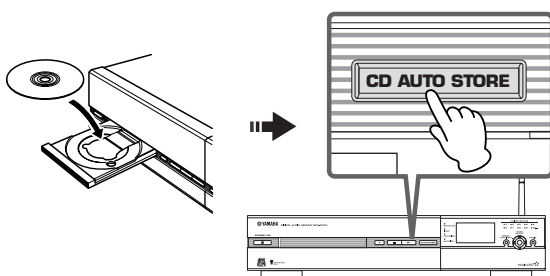

You'll find this operation extremely quick and easy. In addition, since this CD import procedure has no operation screen, you can continue playing audio sources (except for CDs, of course) while importing your music CDs—without interruption.

NOTE If you need to change song data (artist name, album or song title, etc.), see "Editing the Library" (page 75).

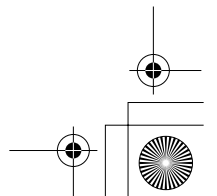
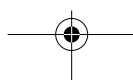
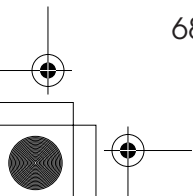

Recording from FM Radio or External Audio Signals

Any incoming audio signals can serve as recordable audio sources for the MCX-2000. If you've appropriately set up the FM antenna (page 4) or connect external audio equipment to the analog and/or digital input jacks (page 9), you can record their sounds at any time using the same recording interface.

NOTE You need to register desired FM stations to the Presets list before recording (page 59).

- 1 From the Recording menu screen, select Store from Radio if you want to record an FM radio program, or select Store from Inputs if you want to record audio signals from external equipment. In either case, the MCX-2000 shows a similar recording screen as follows.

FM station selected from the Preset list

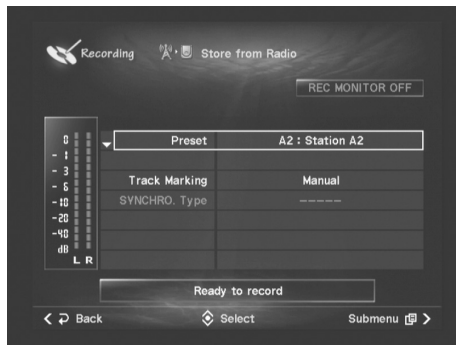

Input selection



- 2 Press the SELECT button on the remote control at the first parameter in the recording screen—Preset or Input, then specify the target FM station or input. If you're in the FM recording screen, you can select an FM station from the Presets list, through the group/station selection dialog box.

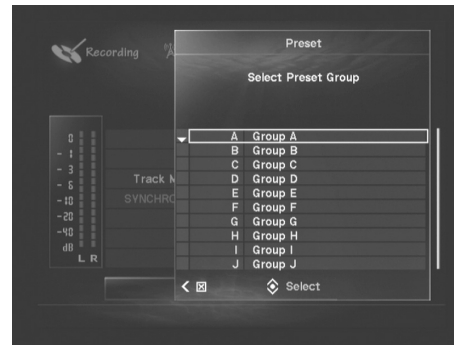

NOTE Internet or XM radio stations (US model only) are shown in gray in the Presets list, indicating they're unavailable for recording. If you select one of these gray items, the MCX-2000 will show "—" at the Preset column indicating no FM radio station is selected. (You cannot start recording.)

- 3 After selecting the target, move the selection (highlight) to the next parameter in the recording screen, Track Marking. Set your preferred recording method as needed. The following parameters are common to both recording screens.

1 Track Marking

Specify how you want to 'divide' the recording. Select Manual if you want to divide the recording manually inserting a track mark, or when you want to manage, for example, a radio program or sounds from a live show as a single song in the music archive. With Manual the MCX-2000 creates a large song file at the point you stop recording. On the other hand, if you want separated songs after the recording, select SYNCHRO. With this option selected, the MCX-2000 automatically inserts a track mark at a predefined silent level (track gap) to separate songs. In either case, you can manually insert a track mark at any point using the Track Marking command from the Submenu.

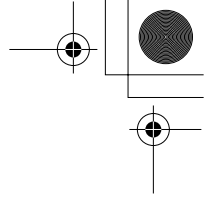

2 SYNCHRO.Type

This parameter is only available when SYNCHRO. is selected for Track Marking above. Select Full Auto if you want fully automatic recording. With this option selected, the MCX-2000 starts recording as soon as it detects the first track gap from incoming signals, and inserts a track mark at the second and following track gap points, then stops recording if a level of silence is maintained for a predefined period. With Full Auto selected, start playing from the 'previous' song on the external audio equipment and the MCX-2000 automatically starts recording at the beginning of the 'next' song—the first song you want to record. When Auto Track Marking is selected, the MCX-2000 only inserts track marks; hence, you should start and stop recording manually.

NOTE If you have no 'previous' song from the source audio, you may want to select Auto Track Marking. Such cases include when you want to record from the beginning of an analog tape played on external equipment or when you want to record a talk program from FM broadcast.

6 When you're ready, move the selection (highlight) to Recording and select Start. If you've selected Full Auto in step 3, the yellow "Ready to Record" message changes to "Pause" and recording will start from the beginning of the next song (Track 0001). Otherwise, the MCX-2000 immediately starts recording with Track 0001.



4 Open the Submenu to set REC Monitor to ON. Simultaneously, REC Monitor becomes available.

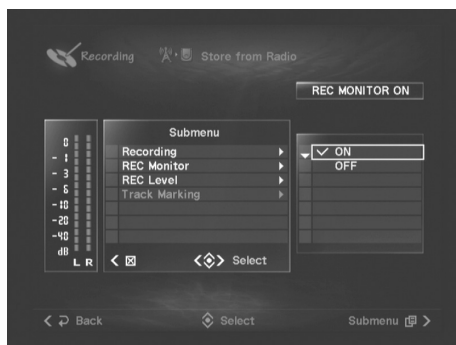

During recording, the track number is incremented every time the MCX-2000 detects a track gap (in Full Auto or Auto Track Marking mode), or when you manually insert a track mark by 'clicking' the Mark button in the Submenu (in all modes).



If you're in the FM recording screen, you can hear a radio broadcast from the selected FM station. If you're in the Inputs recording screen, start playback on the external equipment connected to the selected input jack(s).

5 Adjust the recording level as required, using the bar graph meter, accessible from REC Level in the Submenu. Use the up or down arrow button on the cursor controller to increase or decrease the recording level.

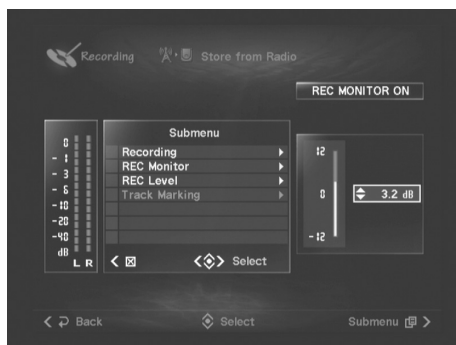

NOTE You can exit the recording screen and enjoy playing other audio sources, unless you need to stay there to monitor recording or manually insert track marks. You can still select the currently recorded audio source from the Library menu; however, changing its settings directly affects the recording.

NOTE You may want to adjust maximum recording levels to go between -3 dB to 0 dB, to gain the volume competing with an average commercial CD.

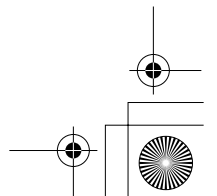
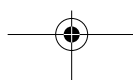
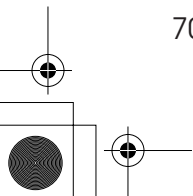

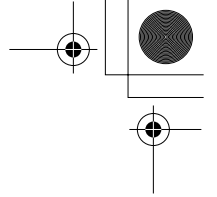

- 7 When the recording is finished automatically, or manually using the relevant Submenu command, you can now exit the recording screen to confirm the recorded results. Select Top Menu > Library > Music Archive > Statistics > Recently Stored Albums.



In this screen, you can locate and confirm what you've recorded. It's in the album named "Album Stored from (...)" and you can select it to confirm the recorded tracks. Try playing them using the relevant Submenu command.

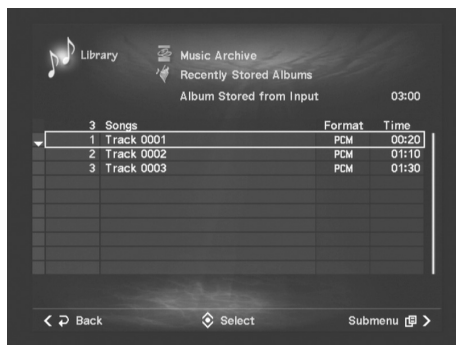

NOTE Because the album name is generic, you can use the Information command to see when the album was created. These albums and tracks are also accessible from other categories in the Music Archive menu (categorized under the "Unknown" artist and genre).

Duplicating a Music CD

This function is useful when you want to make a backup copy of your music CD (CD-DA). When you create an original compilation CD, you can also create as many copies as you want (page 73) ONLY during that creation process. This duplication feature lets you make additional copies LATER from an original CD.

- 1 From the Recording menu screen (page 66), select Duplicate a CD for the following screen.

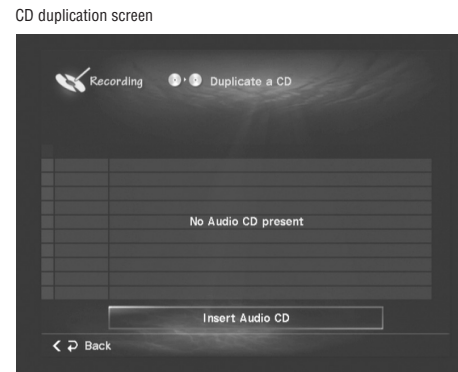

- 2 Set a music CD on the tray, with its label side facing up. Use the OPEN/CLOSE button on the remote control for tray operations. When the MCX-2000 recognizes it as an audio CD (CD-DA), the screen message changes as follows.

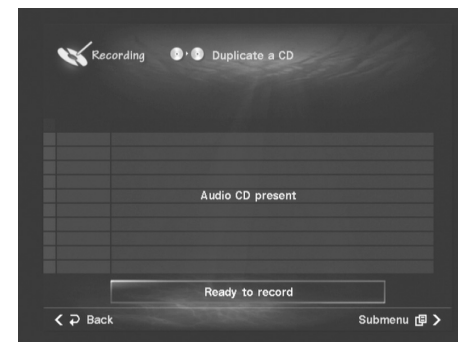

NOTE You will not see any song data (album title, artist name, etc.) in the CD duplication screen.

- 3 Open the Submenu to start CD duplication. The MCX-2000 starts importing the audio data from the CD and creates a temporary disc image file. Select Cancel from the Submenu if you want to cancel the process.

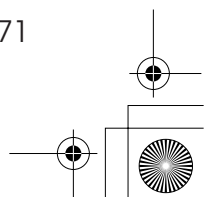
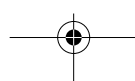
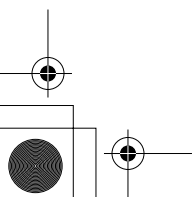

4 When the image file is created, the MCX-2000 shows the following dialog box. To continue the process, open the tray and set a CD-R/RW disc for audio recording with “Change disc and proceed with recording” selected. Select OK in the dialog box.

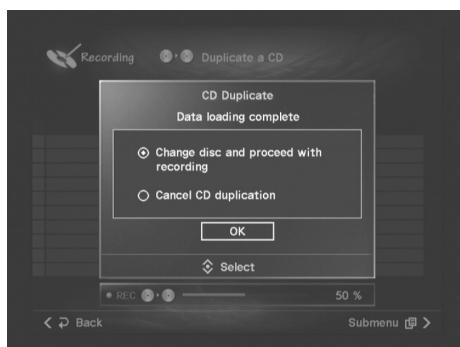

6 When the MCX-2000 detects an appropriate blank disc, it automatically starts writing the image file on that disc.



5 If you set a CD other than one specified, the MCX-2000 prompts you to set a blank disc. In addition, you cannot record onto a CD-R disc that's already been recorded.

If you set a CD-RW disc that's already been recorded, the MCX-2000 shows the following dialog box, asking your answer.

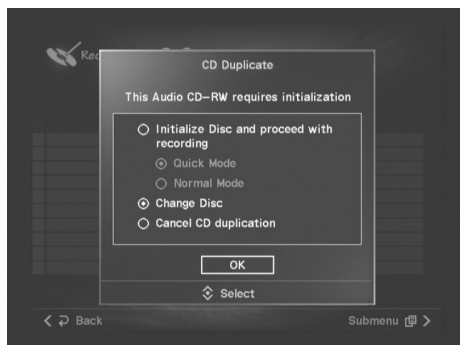

7 When the CD duplication process is finished, the MCX-2000 shows the following dialog box, asking what you want to do next.



Initialize Disc and proceed with recording

Quick Mode: Select this to quickly erase the current disc content and continue the process.

Normal Mode: Select this to completely erase the current disc content (which could take a long time) and continue the process.

Change Disc: Select this if you want to replace the disc with a blank CD-R/RW disc.

Cancel CD duplication: Select this to cancel the process.

Change discs if necessary, using the OPEN/CLOSE button on the remote control for tray operations.

Open CD screen: Select this to finish the process, and open the CD song list screen (page 52) to confirm a list of songs on the duplicated CD.

Create another CD-R/RW: Select this if you want to duplicate another music CD. The MCX-2000 automatically opens the tray and lets you repeat the above procedure from step 2.

Exit this screen: Select this to finish the process.

NOTE When you cancel or finish the process, the original disc image file is automatically erased.

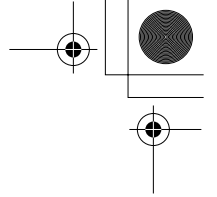

Recording Archived Songs to a CD

As long as you're keeping PCM song data in the MCX-2000 internal hard drive (factory setting), you can create an original music CD based on a playlist or an album from your music archive at any time. It's another great feature the MCX-2000 delivers as your music collection center.

According to your selection, the MCX-2000 shows a dialog box, where you can search for the desired album or playlist in the same manner you search for a song in the music archive.

- 1 From the Recording menu screen (page 66), select Create an original CD for the following screen.



When Album is selected

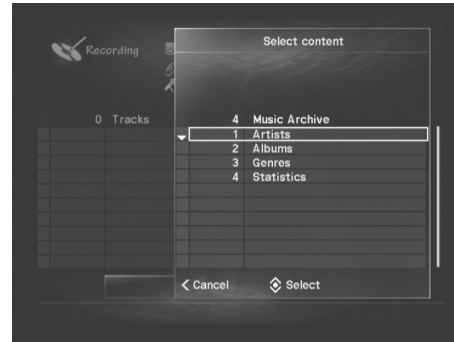

Songs in the selected album or playlist



- 2 According to message shown in yellow, set a blank CD-R/RW disc for audio recording on the tray, with its label side facing up. Use the OPEN/CLOSE button on the remote control for tray operations. When the MCX-2000 recognize it as an appropriate recordable disc, the yellow screen message changes to "Audio CD-R/RW present".

NOTE The MCX-2000 continues showing the same messages above until you set an appropriate disc. In addition, unlike when you duplicate an audio CD (page 72), the MCX-2000 doesn't let you initialize a CD-RW disc that's already recorded.

NOTE When the selected album or playlist contains an MP3-only song (because you selected NOT to keep its PCM song data or deleted it using relevant Submenu commands), the MCX-2000 shows an alert message and discards your selection.

- 3 Specify a playlist or an album you want to record onto the disc, by selecting either Album or Playlist from the Submenu.

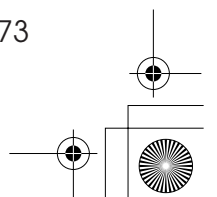
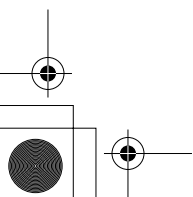

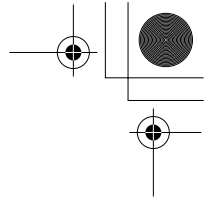

4 A list of songs will be shown in white (only when “Ready to record” is shown). If you want, edit the album title and/or artist name for the CD you’re going to create using the following two commands from the Submenu.

6 When the CD recording process is finished, the MCX-2000 shows the following dialog box, asking what you want to do next.

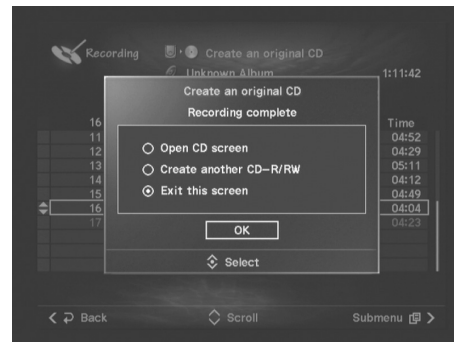

Either command opens the character palette. So, you can type necessary text characters using the palette, or using a PS/2 keyboard connected to the MCX-2000 front panel (page 75).

Open CD screen: Select this to finish the process, and open the CD song list screen (page 52) to confirm a list of songs on a music CD you’ve just created.

5 When you’re ready, start recording by selecting the relevant command from the Submenu. The MCX-2000 writes the songs at 4x speed.

Create another CD-R/RW: Select this if you want to make another CD. The MCX-2000 automatically opens the tray and lets you repeat the above procedure from step 3.

Exit this screen: Select this to finish the process.



NOTE If you cancel the process or exit the operation screen before proceeding to step 5, you may see songs selected in the last session the next time you open this screen. You can clear them by selecting Clear content from the Submenu. You can easily replace songs by selecting another playlist or album using the Select content command from the Submenu (as in step 3 above).

NOTE Archived songs are analog recorded onto a CD-R/RW disc.

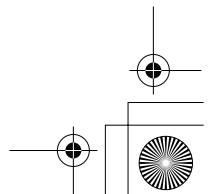
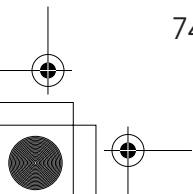

Editing the Library

As you collect more music and audio and expand your MCX-2000 library, you may feel like arranging the content for various purposes—for example, manually edit song data of your favorite CD because it's too new to retrieve correct data from CDDB, or because it's a homemade demo CD from your musician friend. There may also be cases in which you want to change attributes (album or artist) of specific songs to compile your original CD, or you want to delete existing PCM song data to open up space on the MCX-2000's built-in hard drive. In daily use, you may often create several playlists for archived songs, or register a new Internet radio station to the Presets list. This section explains how to customize your music library to your own needs and preferences.

Typing Text Characters

While editing song data from the music archive or while configuring the MCX-2000, you may be asked to specify items (parameter values) with typed text. To facilitate this, the MCX-2000 allows you to type text using the on-screen character palette or a PS/2 keyboard, according to your preference.

Character Palette

When you select Submenu commands such as Edit or New (target), or other parameters that require a text-based value such as Internet URL, you're prompted with a special dialog box as shown below.

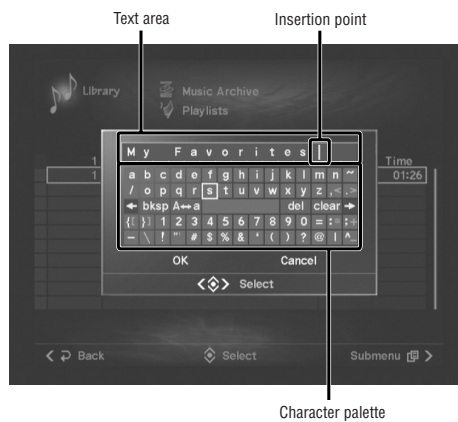

NOTE Text characters shown on the character palette is determined with the Language setting (page 95).

This on-screen keyboard lets you type text only using the cursor controller (arrow keys and SELECT keys). Simply move the selection (highlight) to the character you want to enter at the insertion point, and then press the SELECT key while controlling using the six control keys:

- ← : Moves the insertion point to the left.
- : Moves the insertion point to the right.
- bksp**: Deletes a character on the left of the insertion point.
- del** : Deletes a character on the right of the insertion point.
- clear**: Deletes all characters in the text area at a time.
- A↔a** : Modifies character key functions (uppercase, lowercase and other symbols); currently available characters are indicated in white.

PS/2 Keyboard

Another way to type text characters is to use a PS/2 keyboard connected to the MCX-2000. If you're familiar with typing through a PC keyboard, this option is probably quicker and easier than using the on-screen character palette.

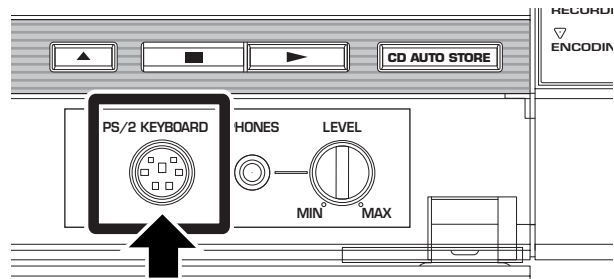

NOTE Always put the MCX-2000 in sleep or standby mode before connecting or disconnecting the PS/2 keyboard. Otherwise, the unit may be damaged.

Simply use the PS/2 keyboard when you're prompted to type characters, together with the character palette. Move the insertion point in the text area using two arrow keys on the character palette (you cannot move the insertion point from the PS/2 keyboard), and then edit or type text characters together with Shift, Caps Lock, Delete and Backspace keys on the PS/2 keyboard. When typing is complete, simply use cursor keys to move the selection (highlight) to OK and press Enter key.

F1	TOP MENU
F2	LIBRARY
F3	MUSIC ARCHIVE
F4	PLAY INFO.
F5	▶ PLAY
F6	⏸ PAUSE
F7	⏹ STOP
F8	RADIO
F9	Edit title (not present on the remote control)
F10	Clear (during title input) (not present on the remote control)
Delete	Delete (not present on the remote control)
Page Up	PAGE ^
Page Down	PAGE v
← ↑ ↓ →	^ / < / > / v (cursor)

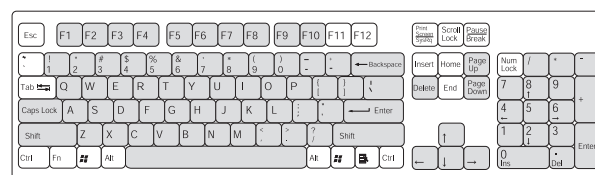

Example of an English PS/2 keyboard

NOTE The MCX-2000 doesn't support text entry using any other keys not mentioned here (such as Ctrl, Alt, Insert, Esc and function keys). In addition, you can use Page Up and Page Down keys in a list view instead of the PAGE scroll buttons on the remote control (page 48).

Web Browser

If you've configured your MCX-2000 to be accessible from your PC network, you can edit existing text information in your music archive using a standard web browser that's running on a computer in the PC network. Text information includes song data (artist name, album title, song title, etc.), playlist name, Internet radio station name and URL, as well as group and station names from the Presets radio list. This feature is very useful when you need to edit a large amount of text information.

To access the MCX-2000 music archive from a web browser, confirm the MCX-2000 IP address in the Server IP Address screen (page 100) and type that address in the URL area of your web browser window and press Enter key on your computer keyboard.

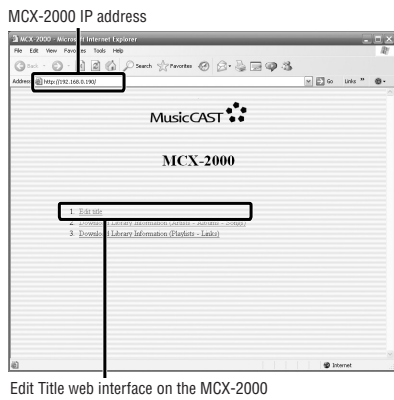

Edit Title web interface on the MCX-2000

From the web interface above, you can perform one of the operations below.

Edit Title

This allows you to edit song data or other text information in the MCX-2000 music archive. When you select a category from a drop-down list, a list of items in that category is shown in the pane. Click a list item to show it in the edit area. From there, you can edit the title or name by typing text on your keyboard. Click OK to determine your edits, or click Cancel to discard them.

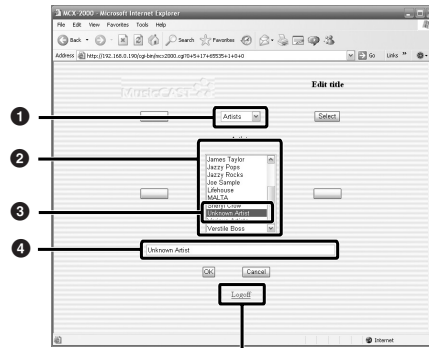

Always Click Log Off when you finish editing

- 1 Category selection (Artists, Albums, Genres, All Songs, Playlists, URLs, Groups and Clients)
- 2 List of items in the current category
- 3 Current selection
- 4 Edit area

If there are over 50 items included in the current category, you can press the "Next 50" button to scroll down the list (or "Prev. 50" button to scroll up the list). If you select Artists, Albums, Genres or Groups for the category, you can track down to 'child' items included in the current item, such as albums in the current genre or artist, songs in the current album, or radio stations in the current group, by clicking the "Select" button. (You can go back to the parent item by clicking the "Back" button.) When you select URLs for the category, you have two edit areas for Internet radio station name and its site URL.

NOTE Library editing is possible for a single computer at a time. If you fail to click "Log Off" when you finish editing, the MCX-2000 doesn't allow editing from a second computer within next 10 minutes.

Download Library Information (Artists - Albums - Songs)

Download Library Information (Playlists - Links)

Each of these lets you download relevant text information from the MCX-2000 music archive in the form of CSV files. You can import these files to your spreadsheet application for management purposes.

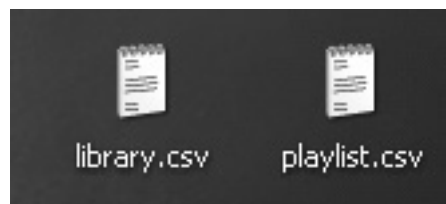

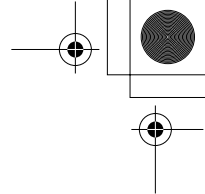

Editing Song Data

Each archived song has unique song data—a series of ‘attributes’ including artist name, album title, genre name and song title—and you can combine these attributes together to use as keywords when finding a song from the music archive. In that sense, song data (as a combined result) is so important to identify a song, that you may need to edit incorrect or generic names and titles to maintain the MCX-2000 music archive as a truly valuable digital music collection.

Editing Titles

When you set a music CD on the MCX-2000, it normally attempts to retrieve song data from the built-in or online CDDB database. If it’s successful, the MCX-2000 shows a list of songs with their titles, artist name and original album title. If the song list is occupied with generic names such as “Track” and “Unknown” and the CDDB Info command from the Submenu cannot update song data (page 93), you can use the Edit title command from the Submenu after importing these songs to the MCX-2000 music archive. When you record songs or audio programs from radios or external inputs, they’re also given a generic “Track” name and sent to a generic album named “Album Stored from (...)” that’s categorized in the “Unknown” genre. Though you cannot retrieve their song data from the CDDB database, you can still change their titles using the Edit title command. In addition, you can even re-categorize renamed songs into an existing or new album, artist and genre (see the next section).

If you see a generic-named item in a list view, just move the selection (highlight) to that item and then select the Edit Title command from the Submenu.



The character palette appears, prompting you to type a new name or title. You can type characters using the palette in the specified manner or using a PS/2 keyboard connected to the MCX-2000, and then select OK in the character palette (page 75).

NOTE If you have a number of generic-named songs, it’s a good idea to start off renaming operations from their album titles. Since the MCX-2000 remembers which “Track 01” song is from which “Unknown” album even after giving the same generic name, you can easily differentiate one “Track 01” song from other “Track 01” songs when opening a song list from Albums (Top Menu > Library > Music Archive > Albums).

Changing Song Attributes

If you’re collecting songs performed by your favorite drummer from a number of albums, you may only import his or her songs to the music archive. This may often produce a situation like too many albums, genres and original artists for a number of songs, but without the drummer’s name at all. More concretely, you have collected several songs performed by your favorite drummer, say, Versatile Boss. Those songs are released from three bands (artists) named Jazzy Rocks, Jazzy Pops and Pop Rockers, and their albums are categorized in three genres—Jazz, Rock and Pop. Your songs are organized in the music archive as below.

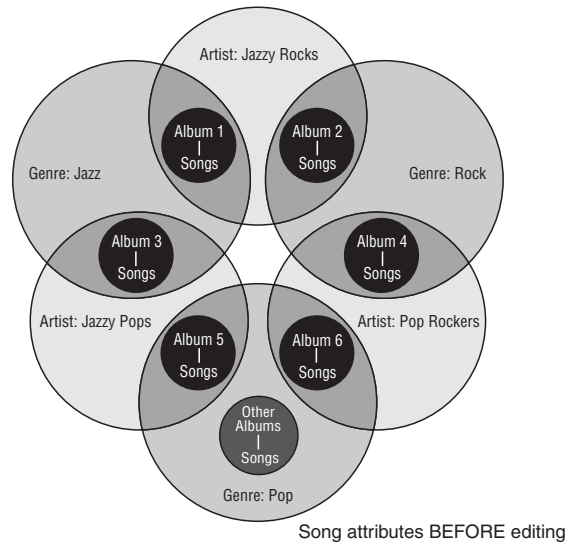

You can solve this problem by collecting the drummer’s songs in a playlist (page 82), but it’s more convenient if you can re-organize those songs with a ‘new’ album, artist or genre created for that drummer as shown below.

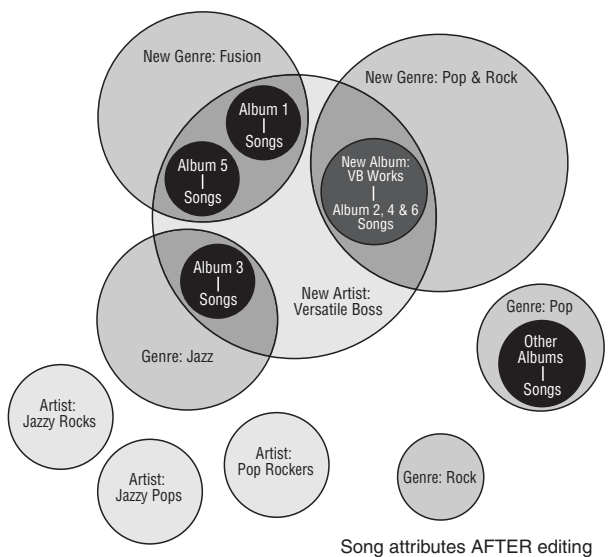

For such purposes, the MCX-2000 even lets you change song attributes—relationships among song, artist, album and genre—to organize your music archive as you wish. From the relevant list view screens, you can access several Submenu commands to manage song attributes:

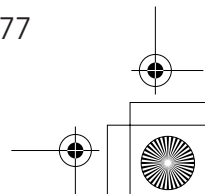
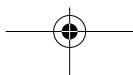
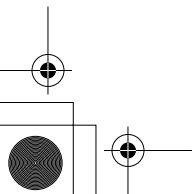

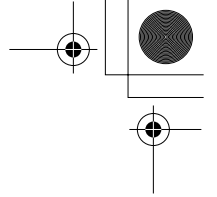

Change Artist: Lets you change the artist for the current album (Music Archive > Artists > selected artist's album list view).

Change Album: Lets you change the album for the current song (Music Archive > Albums > selected album's song list view; Music Archive > Artists > Albums > selected album's song list view; Music Archive > Genres > Albums > selected album's song list view).

Change Genre: Lets you change the genre for the current album (Music Archive > Genres > selected genre's album list view).

New Artist: Lets you add a new artist to the music archive.

New Album: Lets you add a new album to the music archive.

New Genre: Lets you add a new genre to the music archive.

Delete this Artist: Lets you delete the selected artist (and its albums and contained songs).

Delete this Album: Lets you delete the selected album (and contained songs).

Delete this Genre: Lets you delete the selected genre (and its albums and contained songs).

Open source Album: Lets you show the album associated with the current song (Music Archive > All Songs > song list view).

■ Example: How to Organize the Music Archive

Here's a sample procedure to re-organize your music collection as shown in the previous two diagrams, using the relevant Submenu commands.

1 Create three new items (artist, album and genre) using the New (...) command from the Submenu in the relevant list view screen.

- **Versatile Boss:** Top Menu > Library > Music Archive > Artists > artist list view – New Artist
- **Fusion:** Top Menu > Library > Music Archive > Genre > genre list view – New Genre
- **VB Works:** Top Menu > Library > Music Archive > Albums > album list view – New Album

The character palette appears, prompting you to type the name or title for the new item. Select OK after specifying the name or title. Scroll through the current list view to check whether or not each item has been successfully added.

NOTE When you create a new album, you're asked to specify a title and then associate the new album with an 'existing' artist and genre. Hence, in this case you should create Versatile Boss (artist) and Fusion (genre) before VB Works (album).

2 Change the artist for Albums 1, 3 and 5 to Versatile Boss you've just created.

- **Album 1:** Top Menu > Library > Music Archive > Artists > artist list view > Jazzy Rocks > album list view – Change Artist
- **Albums 3 and 5:** Top Menu > Library > Music Archive > Artists > artist list view > Jazzy Pops > album list view – Change Artist

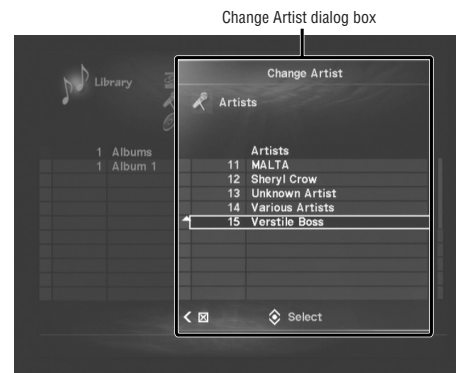

In the Change Artist dialog box, move the selection (highlight) to Versatile Boss and then press the SELECT button on the remote control. Confirm the current album moved under Versatile Boss.



3 Change the genre for Albums 1 and 5 to Fusion you've just created.

- **Album 1:** Top Menu > Library > Music Archive > Genres > genre list view > Jazz > album list view – Change Genre
- **Album 5:** Top Menu > Library > Music Archive > Genres > genre list view > Pop > album list view – Change Genre

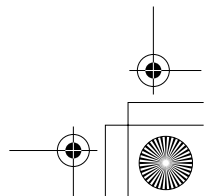
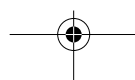
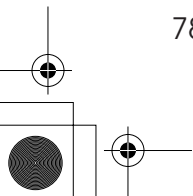

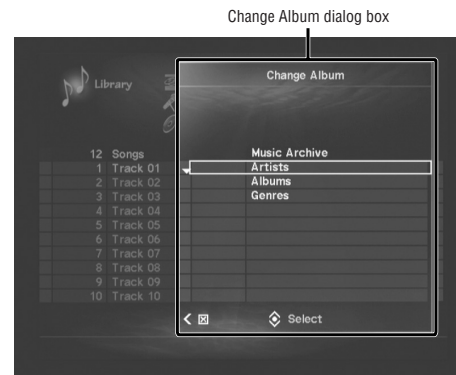
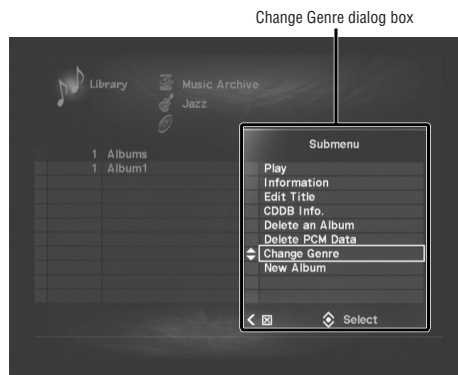
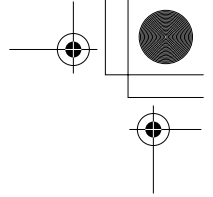

In the Change Genre dialog box, move the selection (highlight) to Fusion and then press the SELECT button on the remote control. Confirm the current album moved under Fusion.

In the Change Album dialog box, you can select a target album by navigating down from Artists, Albums or Genres. In this case, you know the target album title (VB Works) so that it's easiest to navigate down from Albums and select VB Works directly from an album list view. Move the selection (highlight) to VB Works and then press the SELECT button on the remote control. Confirm the current song moved to the end of the VB Works song list.



Now, Albums 1, 3 and 5 are associated with the new artist Versatile Boss and categorized in their corresponding genres. (Album 3 is categorized in its original genre; only its artist has been changed.)

Now, songs from Albums 2, 4 and 6 are compiled into the new album VB Works (associated with Versatile Boss and Pop & Rock). In addition, you can arrange the song order of the VB Works album (or any other album) while showing its song list view. Use the Change Song Order command from the Submenu. You can move the current song to any position in the song list.

4 Change the album for each song from Albums 2, 4 and 6 to VB Works you've just created. You can do this in a song list view accessed from:

- **Artists:** Top Menu > Library > Music Archive > Artists > artist list view (to select Jazzy Rocks or Pop Rockers) > album list view (to select Album 2, 4 or 6) > song list view – Change Album
- **Albums:** Top Menu > Library > Music Archive > Albums > album list view (to select Album 2, 4 or 6) > song list view – Change Album
- **Genres:** Top Menu > Library > Music Archive > Genres > genre list view (to select Pop or Rock) > album list view (to select Album 2, 4 or 6) > song list view – Change Album

Move to a desired position and press the SELECT button on the remote control.



NOTE You can confirm whether song attributes have been changed as you intended, using the Information command from the Submenu in the artist, album, genre or song list view screen (accessed from Top Menu > Library > Music Archive > Artists, Albums or Genres), or the Open source Album command from the Submenu in the song list view screen (accessed from Top Menu > Library > Music Archive > All Songs).

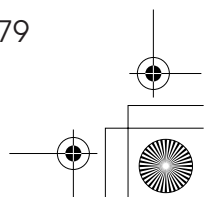
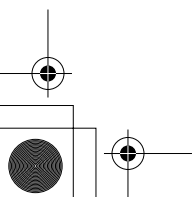

5 When the above procedure is finished, select Top Menu > Library > Music Archive > Artists for the artist list view screen. Notice that the 'previous' artists, Jazzy Rocks, Jazzy Pops and Pop Rockers, have no associated albums or songs.

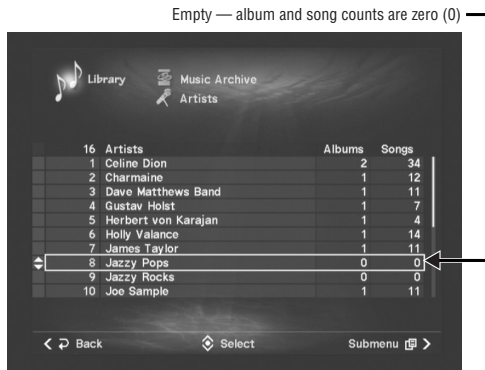

If you have no plan to add songs for these artists, you can delete them one at a time using the Delete this Artist command from the Submenu. Select OK in a confirmation dialog box that appears, and the selected artist is deleted from the list view.



Next, check the 'previous' genres, Rock and Pop, in the genre list view by selecting Top Menu > Library > Music Archive > Genres. Notice that Rock is empty, but Pop still has albums from other artists. You can delete Rock using the Delete this Genre command from the Submenu; but if deleting Pop, you will lose other artists' albums and songs.

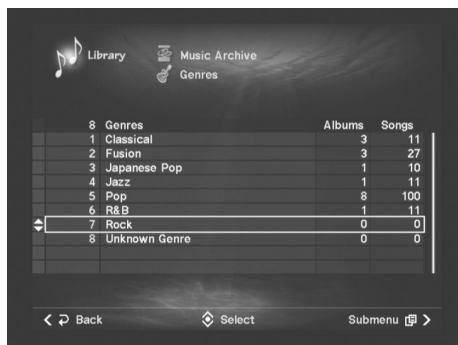

Here, we've shown the general concepts of editing your MCX-2000 music archive. Proper use of the Submenu commands such as New, Change and Delete (...) help you re-organize your music collection.

NOTE Additional Submenu commands, Change Song Order and CDDB Info, are available from the song list view of the "VB Works" album that you've recently created. Though you can arrange the song order using the Change Song Order command, the CDDB Info command doesn't work any longer because VB Works is your own 'private' album.

Deleting the PCM Data

When you record or import CD songs or other audio, the MCX-2000 normally stores them both in PCM and MP3 formats (factory setting), since the unit currently supports original CD creation by compiling PCM song data. If you have no plan to create your original CD and want to save the space on the built-in hard drive, you can use a recording option (page 96) to set the MCX-2000 to import songs only in MP3 format. Keep in mind, however, that this setting change doesn't apply to existing songs (their PCM data still remains). In other cases, you may need PCM data for songs recorded from old analog tape, but not for CD songs. To ensure flexibility for all these requirements, the MCX-2000 lets you delete PCM data for each song individually.

1 Open a song list view screen.



NOTE If you want to delete PCM data for songs from a specific album, open its song list view from Top Menu > Library > Music Archive > Albums. If you want to delete PCM data for any selected songs, open its song list view from Top Menu > Library > Music Archive > All Songs.

2 If necessary, confirm which song has both PCM and MP3 data. Move the selection (highlight) to a target song, and then select the Information command from the Submenu.

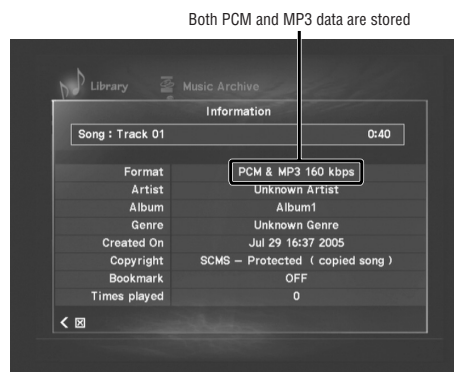

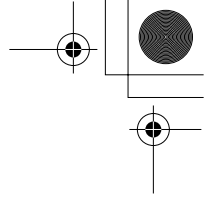

- 3 Select the Delete PCM data from the Submenu. A dialog box appears, where you can specify target songs.

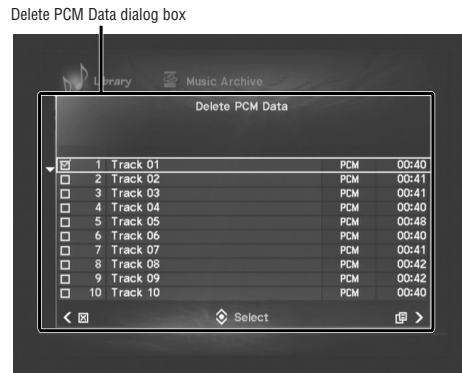

Other Song Delete Options

You can selectively delete PCM song data in the above procedure. If you want to delete all existing PCM song data at a time, go to the Library menu screen (Top Menu > Library). When you move the selection (highlight) to Music Archive, the relevant Submenu commands become available.

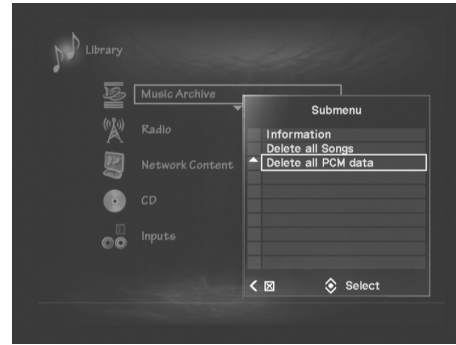

- 4 Move the selection (highlight) to a song whose PCM data you want to delete, and add a check mark by pressing the SELECT button on the remote control. You can remove the mark by pressing the SELECT button again, if you want to keep the song's PCM data.

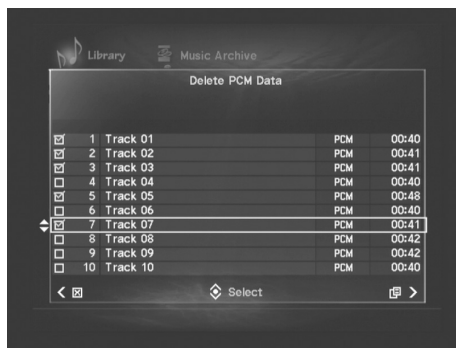

Select the Delete all PCM data command for this purpose. Select OK in a confirming dialog box that appears, and the MCX-2000 will delete all PCM song data. In addition, you can delete all existing songs from the music archive using the Delete all Songs command. It lets you delete both PCM and MP3 data for all archived songs at a time—useful if you want to renovate the music archive with a completely new set of songs or a different MP3 data rate setting (page 96).

You can also use the Delete Songs command that's available from the Submenu in a song list view screen, to delete both PCM and MP3 data for one or more songs in the current song list. Using a similar interface when you import songs from a music CD (page 66), you can select or deselect target songs by adding or removing the check mark using the SELECT button on the remote control, or using the Select all or Cancel all commands from a 'mini' Submenu. Finally select OK from the 'mini' Submenu. Selected songs will be deleted from the music archive right away.

- 5 After you've selected or deselected songs, press the right arrow button on the remote control (like when you open the Submenu) and select OK. When a confirmation dialog box appears, select OK if you're sure.

- 6 A progress bar appears with a "Please wait a moment" message. When the deleting operation is finished, you return to the song list view. If you like, use the Information command from the Submenu to confirm PCM data for the specified songs has been deleted.

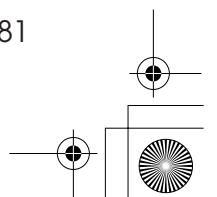
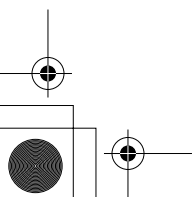

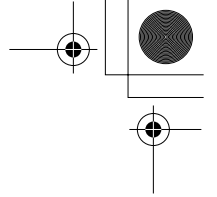

Using a Playlist

The playlists on the MCX-2000 give you new and creative ways to enjoy the songs you've stored to your music archive. Each playlist simply lets you combine and arrange archived songs as you like, but a finished playlist can be used in many ways. Not only can playlist songs be played on the MCX-2000 itself, but they can also be streamed to any MusicCAST client (page 88), if required, along with the timer playback feature (page 89). You can even use playlists to compile your own custom CDs (page 73). This section shows you how to manage your playlists.

Creating a Playlist

You can create a playlist in one of two ways. The most seamless way is to save a bookmark list as a playlist; you can simply add the bookmark to songs in a song list view or each song's Play Information screen, and then go to the Bookmarks screen and save the current bookmark list as a playlist using the relevant Submenu command (page 50). The other way is to create a 'blank' playlists first with a suitable name, and then you can edit or compile it by adding necessary songs later. Here, we explain how to create a blank playlist.

- 1 Select Top Menu > Library > Music Archive > Playlists for the following screen.

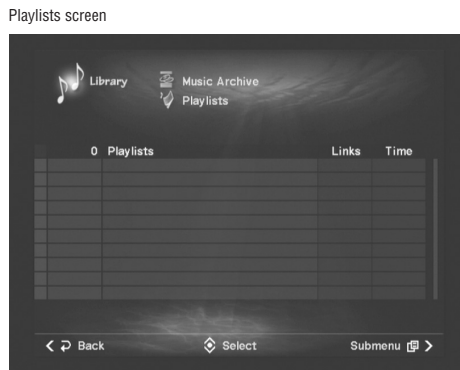

- 2 Select the New Playlist command from the Submenu. The character palette appears, prompting you to type the name for a new playlist. Specify the name using the palette or using a PS/2 keyboard connected to the MCX-2000, and then select OK in the character palette (page 75).



- 3 Confirm the new playlist appears in the Playlists screen.

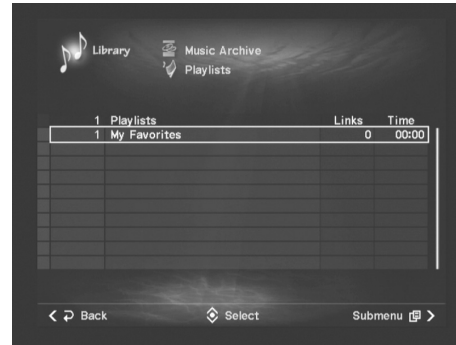

Other Submenu commands available from the Playlists screen:

Play: Lets you play the selected playlist, from the first song in the list. In the Play Information screen, you can select other playlists using the group selection buttons (+/-). For other playback controls, see "Play Information and Controls" (page 50).

Information: Shows a dialog box that provides detailed information about the selected playlist.

Add Link: Lets you add a song to the selected playlist. You can search for the desired song by navigating down from a 'mini' Music Archive menu, in the same manner you search for a song in the music archive.

Edit title: Lets you edit the selected playlist's name using the character palette or a PS/2 keyboard connected to the MCX-2000 (page 75).

Delete this Playlist: Lets you delete the selected playlist and its content (links). When you select this command, a confirmation dialog box appears. Select OK if you're sure. Deleting a playlist doesn't delete the original song data.

NOTE Once created, each playlist shown in the Playlists screen is managed in the same way. You can add or remove songs from a playlist, even when it was 'converted' from a bookmark list.

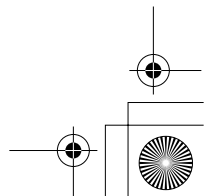
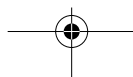
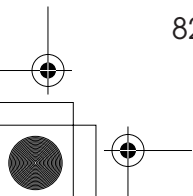

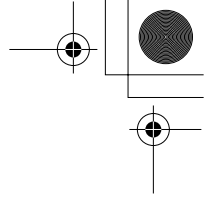

Editing a Playlist

Each song title in the playlist is simply a reference point (link) to its original song data. In other words, the actual song data is not affected when you add, remove or move songs to the playlist; only the links are changed. The MCX-2000 even allows you to add or remove links while playing the current playlist, and the unit continues playing according to a resulting playlist.

NOTE You cannot edit a playlist that's being used to create (record) your original CD.

- 1 From the Playlists screen, select a playlist you want to edit. If you move the selection (highlight) to an empty playlist and press the SELECT button on the remote control, the MCX-2000 prompts you to use the Add Link command from the Submenu.

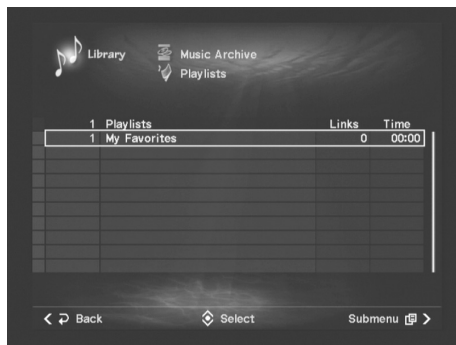

No other Submenu commands available



If the selected playlist is not empty, the MCX-2000 shows songs linked from that playlist.



- 2 From the song list view, you can perform the following operations using the relevant Submenu commands.

Play: Lets you play the current playlist, starting from the selected song. In the Play Information screen, you can select other playlists using the group selection buttons (+/-). For other playback controls, see "Play Information and Controls" (page 50).

Information: Shows a dialog box that provides detailed information about the selected song.

Add Link: Lets you add a song to the current playlist. You can search for the desired song by navigating down from a 'mini' Music Archive menu, in the same manner you search for a song in the music archive.

Remove Links: Lets you delete one or more links from the current playlist. Select or deselect target links by adding or removing the check mark using the SELECT button on the remote control, or using the Select all or Cancel all commands from a 'mini' Submenu. Finally select OK from the mini Submenu. Selected links will be removed right away. Deleting a link doesn't affect the original song.

Change Link order: Lets you move the position of the selected song in the current playlist. Move the song to the desired position using the up or down arrow button on the remote control, and then press the SELECT button.

Open source Album: Opens the album associated with the selected song.

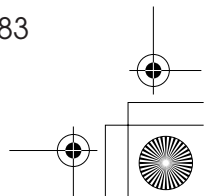
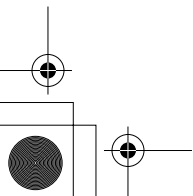
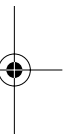

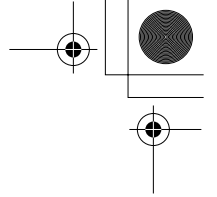

Registering an Internet Radio Station

The MCX-2000 comes with five Internet radio stations preassigned. But, not to mention, there're hundreds of thousands of online radio stations all over the Internet, and you may already enjoy some of them on your computer. Now you can even add your favorite online radio stations to the MCX-2000 library, and enjoy them together with other audio sources.

- 1 Select Top Menu > Library > Radio > Internet Radio, for the list of Internet radio sites.

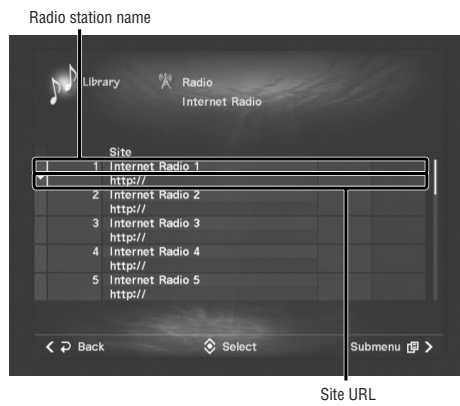

- 3 Specify a new radio site using the following two Submenu commands. Either command opens the character palette. So, you can type necessary text characters using the palette, or using a PS/2 keyboard connected to the MCX-2000 front panel (page 75).



Edit Site title: Specify the radio station name here.

Edit URL: Specify the radio station site URL (server name) or IP address here. In either case, this parameter value must be specified starting with "http://" and ending with a slash (/), even though the column accepts any text character (no alert appears if text is invalid).

Clear this Site: Select this if you want to delete an existing Internet radio station registered at the current column. When a confirmation dialog box appears, select OK if you're sure. The column becomes unregistered.

NOTE When you specify a radio station site with a URL, you should also specify at least one active DNS server for the MCX-2000 to successfully find the specified site (page 37).

- 2 Move the selection (highlight) to a column where you want to add a new Internet radio station. The site list can hold up to 40 online radio stations, so scroll through the list as required.

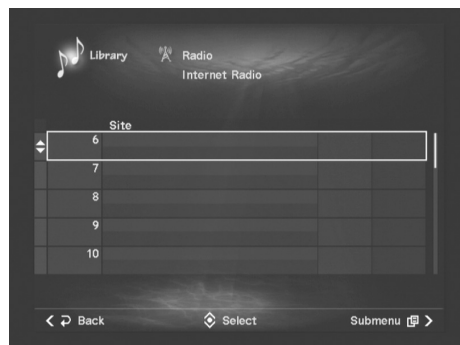

- 4 Repeat steps 2 to 3 as required.

In addition to the above procedure, Internet radio stations can be registered or edited through a web browser (page 76). When you find a new radio station on the web, simply copy its URL and paste it to the site list opened in a web browser.

NOTE You can overwrite an existing station. If the old station is registered to the Presets list (page 59), the new station replaces it when you select it from the Presets list.

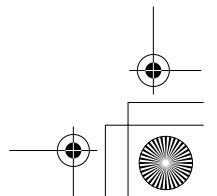
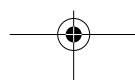
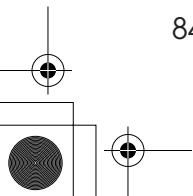
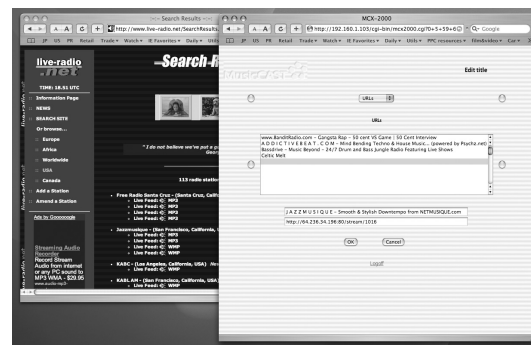

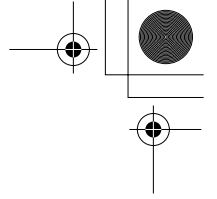

Renaming Items from the Radio Presets List

You may have already registered a number of radio stations using the Save to Preset command while listening (page 59), or using the FM Auto Preset command (page 62) when you previously opened the Presets list screen to cover all FM stations in your area. These two commands are convenient, but they simply add radio stations to the Presets list, leaving default names such as Group and Station (or FM frequency for an FM station). As the Presets list is used for recording or timer playback, you may want to give each list item a more comprehensible name. Here's how to do it.

- 1 Select Top Menu > Library > Radio > Presets, for the Presets list screen.

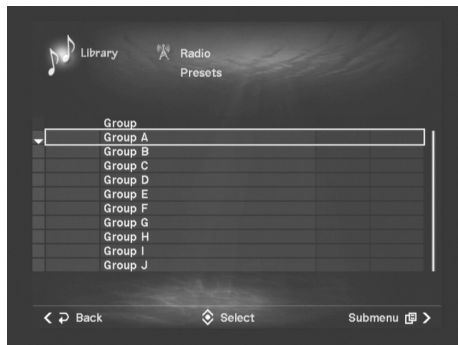

- 2 Move the selection (highlight) to a radio station group whose name you want to change, and then select the Edit title command from the Submenu. When the character palette appears, type a new name using the palette, or using a PS/2 keyboard connected to the MCX-2000 front panel (page 75). Select OK in the palette when you finish typing.



- 3 When you return to the group list view, repeat step 2 for other groups. Otherwise, select a group that lists stations you want to rename.

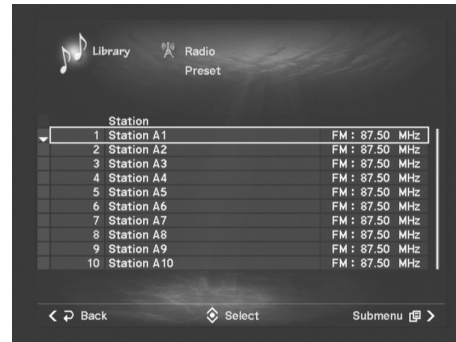

- 4 Move the selection (highlight) to the radio station whose name you want to change, and then select the Edit title command from the Submenu. You can rename it in the same manner as you did in step 2 above. Select OK in the palette when you finish typing.

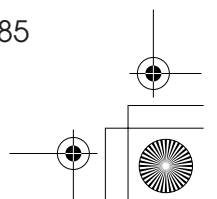
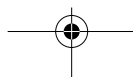
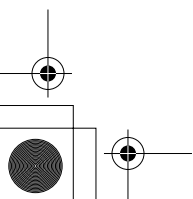
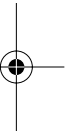
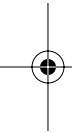

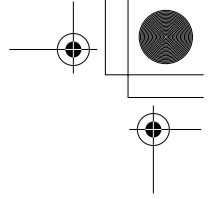

5 When you return to the station list view, repeat step 2 for other stations.

You can repeat steps 2 to 5 above to completely rename up to 100 radio stations from 10 station groups—however, that’s too laborious and time-consuming (if you do it at a time). A much easier and faster way is to rename items on a computer, using a web browser (page 76).

Click Select for a station list view.

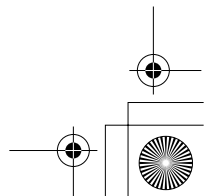
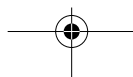
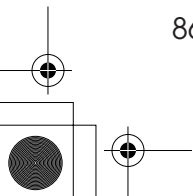
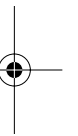
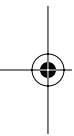
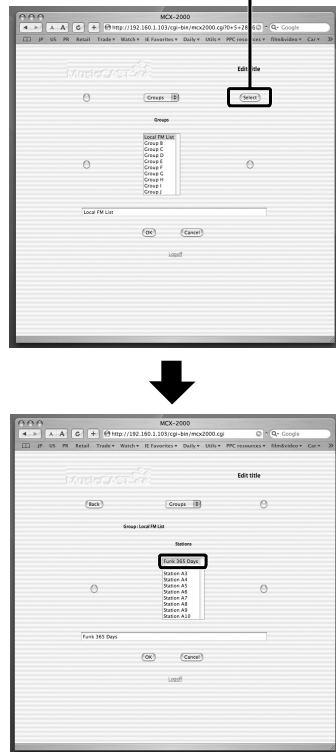

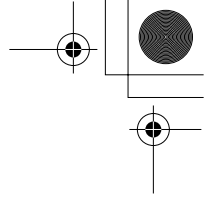

Operating a Client Remotely

Once you've created a MusicCAST network, each MusicCAST client becomes able to access the MCX-2000 and share most audio sources on the server, including the music archive, FM radio stations and audio signals from external inputs. In fact, each client automatically retrieves the latest catalog of songs, artists, albums, genres and radio stations, and lets you initiate audio streaming by selecting an audio source on the client side (client request).

You can also initiate audio streaming to each client from the server side. Besides the Broadcast feature that streams a single audio source selected on the MCX-2000 to one or more clients at the same time (page 89), you can even issue a client request on the server side—using one of the Client Control functions. It's another value of the MCX-2000 as the center controller in your MusicCAST network. This section describes how you can manage your MusicCAST clients remotely.

NOTE For more information on how to stream audio to your clients, based on the client request, see the manual that came with your MusicCAST client.

- 1 Select Top Menu > Client Control for the following screen.

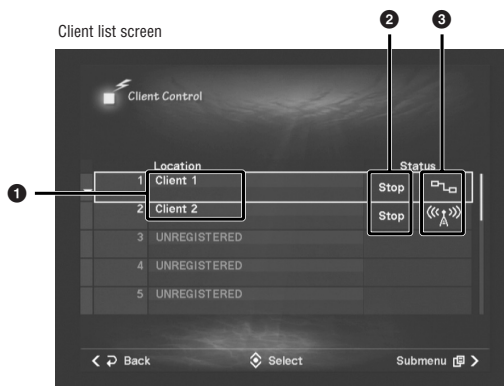

- 1 Client name
- 2 Activity
- 3 Network connection

This client list screen lets you view the current status of each registered client. While checking each client status, you can remotely control general client activities using the Submenu commands in this screen. Move the selection (highlight) to one of registered clients, and select a Submenu command you want to use:



View Play Info: Shows the Play Information screen for the selected client. If the audio source selected on the client is a song from the MCX-2000 music archive, you can further add or remove the bookmark using the Submenu > Bookmark command in the Play Information screen as using the BOOKMARK button on the client remote control.

Playback: Lets you start or stop playback of the audio source currently playing on the selected client.

Timer: Lets you turn on or off the timer playback feature (page 89) on the selected client.

Power: Lets you turn on or off the selected client, or change its power mode. If you select Sleep, the client enters sleep mode showing "Remote Sleep" (forced sleep mode by the MCX-2000 operation). You can awake the client by pressing its controller button if it's not locked (see Lock).

Lock: Use this to prevent operations on the selected client. With ON, the client only accepts volume control with the VOL -/+ and MUTE buttons, time display (when the MENU button is double clicked for the current time) and stop playback of what's being played (you cannot resume playback). This function is useful if your client is in a public place.

Edit Client title: Lets you edit the selected client's name using the character palette or a PS/2 keyboard connected to the MCX-2000 (page 75). Read the following note.

Receive PCM Stream: Lets you specify whether the selected client prioritizes PCM song data for playback of archived songs. With ON, the MCX-2000 streams PCM data for the selected archived song to the client. However, PCM songs can simultaneously be streamed to up to 3 clients—3 wired clients, or 2 wired clients plus a single wireless client. So, even if you've enabled this parameter for two or more wireless clients, the MCX-2000 will stream songs in MP3 format to the second and following wired clients.

Recall Play: Makes the selected client start 'continued' playback of a song currently playing on the MCX-2000 server or another client specified in a dialog box (page 90).

Control all Clients: Provides options to control all clients at a time—starting or stopping playback of the audio source currently selected at each client, as well as enabling or disabling the timer playback feature on each client (page 89).

NOTE If you arrange the client list using the Change Client order command from the Submenu in the Manual Configuration screen (page 43), client names you specified with the above Edit Client title command will be reset to the default (Client #).

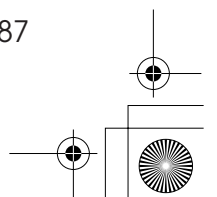
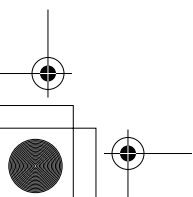

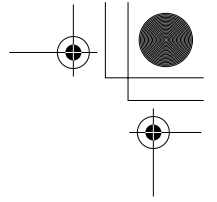

Selecting the Client Audio Source

Furthermore, when selecting a client by pressing the SELECT button on the remote control, you can specify the audio source to be streamed to that client in the following screen.

When selecting Radio, the MCX-2000 shows the Presets radio station list. You can select a preset FM station for the selected client in the same manner as for the MCX-2000 (page 60).

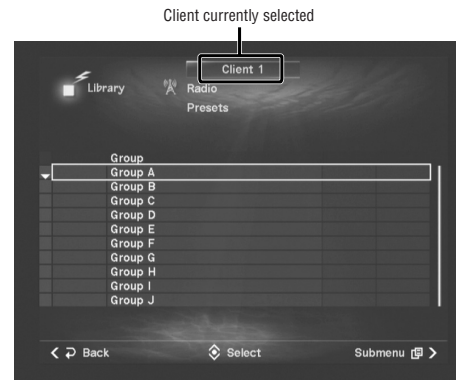
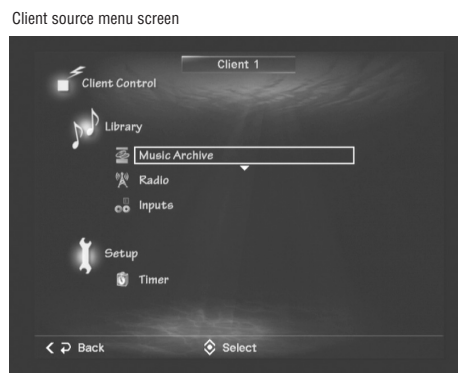

This menu screen has two sections, where you can specify the audio source to be streamed to the selected client. Select one of three audio sources under Library: Music Archive, Radio and Inputs.

When selecting Inputs, you can access the Inputs menu (page 63). Of course, audio signals from these input jacks are shared between the MCX-2000 and all clients. You can select a different input for each client, and the MCX-2000 can stream both digital and analog input signals to different clients at the same time.

When selecting Music Archive, you can browse and select archived songs or playlists from seven distinct categories through the familiar Music Archive menu interface (page 46).

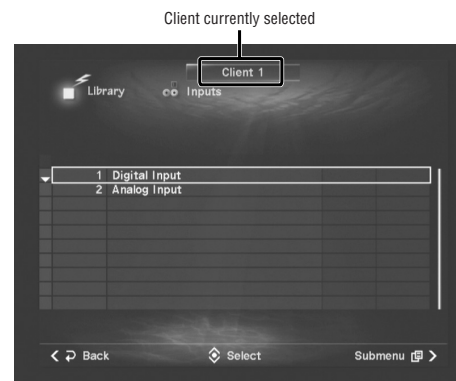

For detailed procedure and notes, refer to the relevant sections in "Playing Audio Sources" (page 46).

NOTE As a general rule, you should note that archived 'on-demand' songs can be separately selected and streamed to clients. But, incoming 'relayed' sources such as radio and input signals are shared with all clients (and MCX-2000) and, therefore, have some limitations in streaming:

A single FM radio station is shared between the MCX-2000 and all clients. Naturally, the built-in FM tuner receives a single station at a time, so it tunes in to the FM station last selected. If the MCX-2000 (or other client) is playing an FM broadcast program and a second unit selects another FM station, the server (as well as all other clients) immediately starts playing the last selected station.

Internet radio stations cannot be 'selected' from clients. If you attempt to select an Internet radio station from the Presets list, it's shown in gray indicating it's unavailable for clients. However, you can still stream Internet radio programs by broadcasting them to any selected clients. (Select an Internet radio station on the MCX-2000 and start broadcasting using the relevant Submenu command in the Play Information screen.)

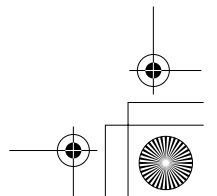
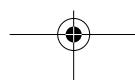
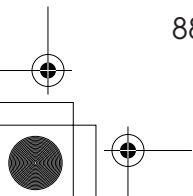

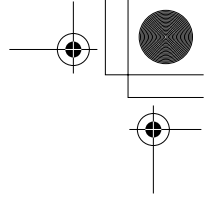

Setting the Timer Playback

At the lower section in the client source menu screen, you can access the timer playback feature for clients, the same feature available for the MCX-2000 when you select Top Menu > Setup > Timer. When you select Timer, the timer playback list screen appears, where you can create up to 10 timer programs by specifying a playlist or a preset radio station to be played at the specified time on the specified date.



Move the selection (highlight) to a column to specify a timer program, and then press the SELECT button on the remote control for the timer program list screen. You can create a timer program for the selected client here, in the same manner as for the MCX-2000 (page 97).

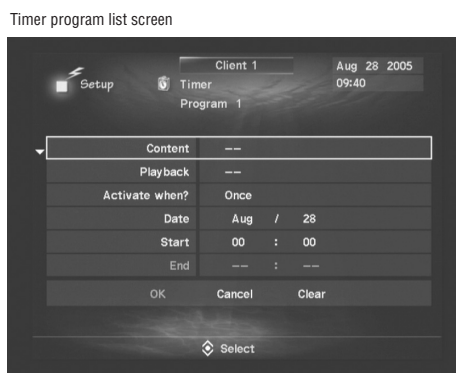

NOTE Internet radio stations cannot be selected from the Presets list. See also the previous note (page 88).

For detailed procedure and notes, refer to the relevant sections in “Using the Timer Playback” (page 97).

NOTE While you're editing (or simply viewing settings) in the timer program list screen, the MCX-2000 doesn't activate existing timer programs.

MusicCAST as an Integrated Music Delivery System

While playing music on the MCX-2000 itself, you can seamlessly initiate music streaming to any MusicCAST client. Everybody can just operate a MusicCAST client to browse through audio sources on the server and select a desired item—artist, album, genre, song, playlist, or radio station—to listen to it on the client. On the other hand, you can limit operations from the client side using the Lock command from the client list screen (page 87) if you use MusicCAST clients in a public space, such as show room or shop floor.

Other convinient features for the MCX-2000 and MusicCAST clients are found in the Broadcast and Recall Play commands available from Submenu in the Play Information screens.

Broadcast

As its name implies, the Broadcast command lets you stream a audio source selected (and playing) on the MCX-2000 to all specified clients. When you select the command, the MCX-2000 shows the following dialog box.

Broadcast dialog box

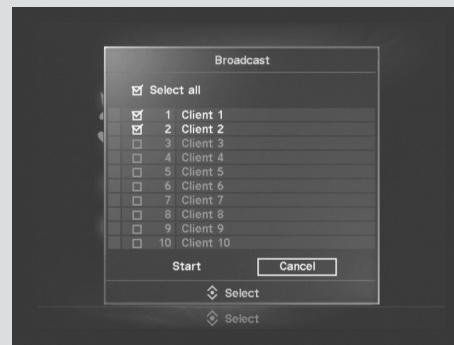

Add a check mark to clients to which you want to broadcast the audio source currently playing (or selected) on the MCX-2000. When you select OK, broadcasting is initiated and selected clients start playing the same audio source.

Now broadcasting

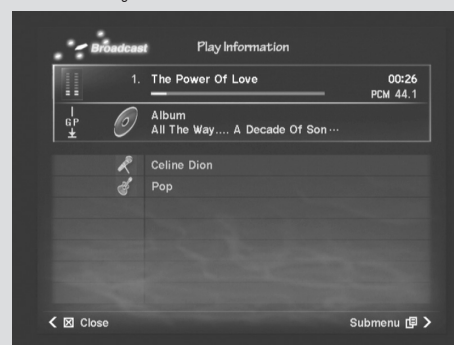

You can stop broadcasting any time by pressing the BROADCAST button on the remote control. Select OK in the dialog box that appears. When broadcasting is stopped, the MCX-2000 and selected clients stop playback. Other clients (not selected for broadcasting) continue playing.

NOTE Though Internet radio stations cannot be selected or requested from the client side or through the client source menu screen (page 88), they can be easily streamed using the Broadcast command on the MCX-2000 side.

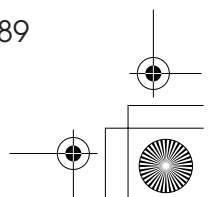
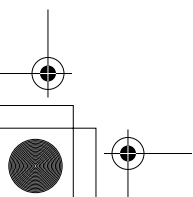

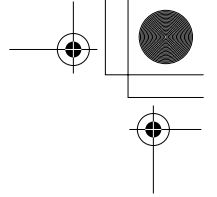

Recall Play

This feature lets you relay the audio source being played (or last selected) on a MusicCAST system to another MusicCAST system. When you select the Recall Play command, the MCX-2000 shows the Recall Play dialog box with a list of MusicCAST clients.

Recall Play dialog box for the MCX-2000

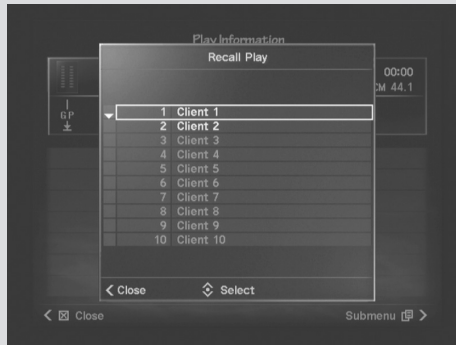

Submenu in the client list screen (page 87) provides access to the Recall Play feature on each MusicCAST client. When you select the Recall Play command for the selected client, the Recall Play dialog box also appears with a similar list including the MCX-2000 (Server).

Recall Play dialog box for clients



In either dialog box, you can specify a 'source' system for continued playback (whose current song and the current playback point will be relayed to the 'destination' system—a MusicCAST system you're operating). Keep this in mind especially when you're remotely operating a client and specify another client as the source system.

NOTE If you attempt to relay an Internet radio station currently played on the MCX-2000 to one of MusicCAST client, you will see the "Playback unavailable" message on that client. See also the previous note (for the Broadcast feature).

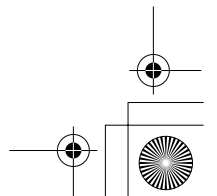
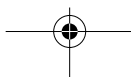
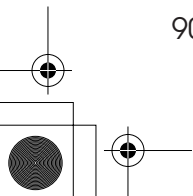

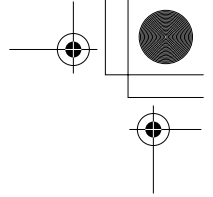

Other Features

Your MCX-2000 is fully functional simply configured with Easy Setup. But, it becomes more convenient and useful if you fine tune the unit to suit your need. If you have a broadband Internet connection and already made it accessible from the MCX-2000 via your PC network (page 26), you may want this configuration to fully work. Plus, if you're such an audiophile as to own a high-end audio system with a Yamaha AV receiver, you have a good reason to integrate your MCX-2000 there. Furthermore, you can use the timer playback feature to automatically start music on the MCX-2000 and any MusicCAST client at the specified time. This section explains how to set up and use the MCX-2000 for such nifty functions.

Setting Date and Time

Every MusicCAST client can automatically correct its internal clock to match that of the MCX-2000, over the MusicCAST network. Because this mechanism sets each MusicCAST system the same time, accuracy of the MCX-2000 internal clock becomes the more important. When you select Top Menu > Setup > Date/Time, you can configure the server's internal clock in several ways.



Auto Setup

PC users may know their computers can retrieve accurate date and time settings from the Internet. There are special servers called NTP (network time protocol) servers on the Internet, which publicly serve accurate time retrieved from a GPS system or an atomic clock. Since the MCX-2000 can access one of these servers to correct its internal clock, other MusicCAST clients can then correct their date and time settings accordingly.

Manual Setup

When you turned on the MCX-2000 for the first time, Easy Setup lets you specify several basic settings including date and time (page 28). If you don't use automatic correction using a time server, manually adjust date and time once in a while.

Time Display

You can specify how the MCX-2000 internal clock shows the current time. Since your settings are transferred to each client over the MusicCAST network, you can automatically unify the clock display on all MusicCAST systems.

Correcting Date and Time Automatically

- 1 Select Top Menu > Setup > Date/Time > Auto Setup.



- 2 Select the first item, "Use NTP Server" and set to ON. When you set this parameter to ON, the following three parameters become available.

NOTE When you use an NTP server (ON), manual setup of date and time are disabled.

1 Server Address

Specify an NTP server you want to use for date and time correction with its URL (server name) or IP address. When URL is specified, it's necessary that the MCX-2000 can connect at least one active DNS server to find the time server (page 37).

2 Time Zone

Specify from the list where you're using the MCX-2000 and clients. If your locale isn't in the list, select the closest city or a time difference value from GMT (Greenwich mean time) for your locale.

3 Daylight Saving

Select this to ON if your locale where you use the MCX-2000 and clients is in daylight saving time. (Time goes fast by one hour.) If not, set this parameter to OFF.

NOTE If you're using a time server on your computer, specify the same values to the above parameters. In addition, you should specify a public NTP server. Don't specify a private one.

- 3 When you select OK, the "Saving..." message is shown and the MCX-2000 immediately starts querying to the specified NTP server. When the MCX-2000 receives the response from the server, its internal clock is corrected right away and the result is soon reflected on each MusicCAST client.

NOTE Once the MCX-2000 starts using the NTP server, its internal clock will automatically be corrected every one hour.

Setting Date and Time Manually

- 1 Select Top Menu > Setup > Date/Time > Manual Setup.



NOTE If you specified to use an NTP server (ON) in the Auto Setup screen, manual setup is disabled. (You will see an alert message telling so.)

- 2 Change each parameter value as needed, and specify the current date and time.

1 Year

Available values: 2005~2030 (factory setting: 2005)

2 Month

Available values: 1~12 (factory setting: 1)

3 Day

Available values: 1~31 (factory setting: 1)

4 Hour

Available values: 0/12 AM ~ 11 AM, 0/12 PM ~ 11 PM; 0~23 (factory setting: 0 AM; 12-hour clock for US and Canada models, 0; 24-hour clock for other models)

5 Minute

Available values: 0~59 (factory setting: 0)

- 3 When you select OK, the "Saving..." message is shown. The MCX-2000 immediately resets its internal clock as specified, and the result is soon reflected on each MusicCAST client.

NOTE When you set the date in the order of year, month and day, available Day values are within a 'reasonable' range for the specified Month. If you specify June ("6" for Month), the maximum Day value becomes "30". If you specify February, the maximum Day value becomes "28" or "29" depending on the Year value. If you set each date value at random, you can even specify June 31. Since incorrect date settings are 'translated' into the correct ones after saving operation, June 31 becomes July 1. In addition, the Hour values automatically change in 12-hour or 24-hour clock (plus, 0 or 12 for noon and midnight) according to the Time Display format.

Selecting the Time Display

- 1 Select Top Menu > Setup > Date/Time > Time Display.



- 2 Change each parameter value as needed.

1 24 or 12 hours

Select either 12-hour or 24-hour clock for the time display (factory setting: 12). When "12" is specified, the next parameter becomes available.

2 Noon & Midnight

Select either 00:00 or 12:00 for noon and midnight (factory setting: 00:00).

- 3 When you select OK, the "Saving..." message is shown. The specified format is immediately applied to the time display on the MCX-2000 and each MusicCAST client.

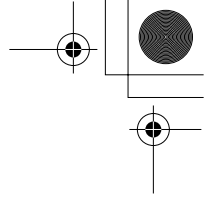

Using the Online CDDB Database

The MCX-2000 incorporates a part of Gracenote CDDB database and uses it to retrieve and display song data for music CDs (factory setting). The online CDDB database is, however, always being updated according to the latest CD releases in the whole world. So, if you have an Internet connection and make it accessible from the MCX-2000, you can be sure to retrieve song data for your CDs.

- 1 Select Top Menu > Setup > CD Lookup.

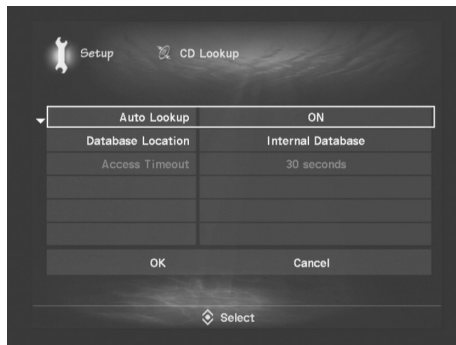

- 2 Change each parameter value as needed.

1 Auto Lookup

Specify whether the MCX-2000 automatically starts searching song data in the CDDB database when you set a music CD on the unit (factory setting: ON). With OFF, the MCX-2000 doesn't start automatic search, so that all song data will be shown with generic names (Unknown or Track). If you want to start playing or recording (importing) a music CD as soon as you set it (because you know song data can be retrieved later, even when CD tracks are archived), specify this parameter to OFF.

2 Database Location

Specify which CDDB database to be used for retrieving song data. If you only use the built-in database, select Internal Database (factory setting). With this option selected, the following Internet-relevant parameter become unavailable. Oppositely, if you select Internet Database, the MCX-2000 doesn't use the built-in database at all. You may select Internal Database if you're using the MCX-2000 without Internet connection.

3 Access Timeout

Specify how long the MCX-2000 is allowed to wait after querying to the online CDDB database, within a range between 30 to 300 seconds. If your Internet access is fast enough, you can leave this value as it is (factory setting: 30 seconds) because the online database normally responds in a few seconds. But, if you specify a small value for slow Internet access (such as modem dial-up access), there may be a case the MCX-2000 stops waiting before the CDDB response is returned. This results in no applicable song data. So, specify a value that's large enough for your Internet access speed.

- 3 When you select OK, the "Saving..." message is shown. The MCX-2000 afterward retrieves song data in the specified manner.

NOTE For quicker access of CDDB data, the MCX-2000 is designed to keep song data for last 100 music CDs (maximum) retrieved from the online CDDB database. However, you can ignore existing data by retrieving the latest data using the CDDB Info command available from the Submenu in several Music Archive screens.

Defining User Interface

Your MCX-2000 becomes more usable if you customize the unit according to your preferences. Select Top Menu > Setup > User Interface, find how you can customize the MCX-2000.

User Interface menu



Front Panel Display

You can adjust brightness and contrast of the MCX-2000 front panel display.

Page displayed at Power ON

When connected to the AC power source or waking up from sleep or standby mode, the MCX-2000 normally displays the Top Menu screen. You can change it to a screen last shown before the display goes off.

Screen Saver

The MCX-2000 operation screens (on the TV monitor) goes off when the unit enters sleep or standby mode. In addition to this, you can set the screen display to automatically go off after the specified duration. Use this feature to prevent monitor burnout.

Language

You can select a language used to show text messages in the front panel display and TV monitor screens. This is the same parameter you first set with Easy Setup (page 27). Use this when you want to change the user interface language.

PS/2 Keyboard

You can select the type of your PS/2 keyboard connected to the PS/2 port on the MCX-2000 front panel. This is an essential setting for your keyboard to properly work.

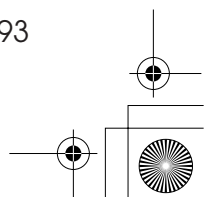
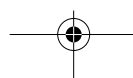
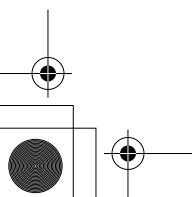
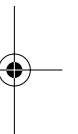

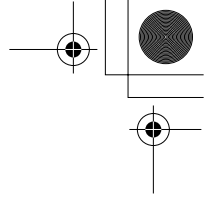

Front Panel Display

- 1 From the User Interface menu, select Front Panel Display.

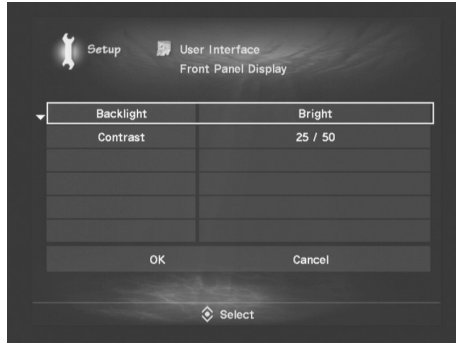

- 2 Change each parameter value as needed.

1 Backlight

Make the display backlight either Bright or Dark.

2 Contrast

Set the display contrast as you can clearly see it (0-50; factory setting: 25). Be sure that an extremely high or low value makes your display hard to be seen.

- 3 Your change is reflected in real time. When you select OK, the "Saving..." message is shown and new settings are stored.

Page Displayed at Power ON

- 1 From the User Interface menu, select Page displayed at Power ON.

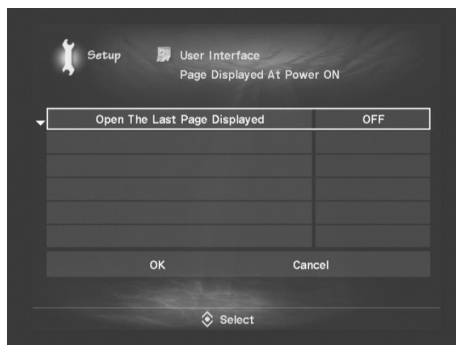

- 2 You have just one parameter, Open the last page displayed, for this setting. Select ON if you want the last shown screen to be displayed when the MCX-2000 is connected to the AC power source or waking up from sleep or standby mode. Select OFF if you want the Top Menu screen to be displayed (factory setting).

- 3 When you select OK, the "Saving..." message is shown. The MCX-2000 afterward shows a screen as specified here.

Screen Saver

- 1 From the User Interface menu, select Screen Saver.

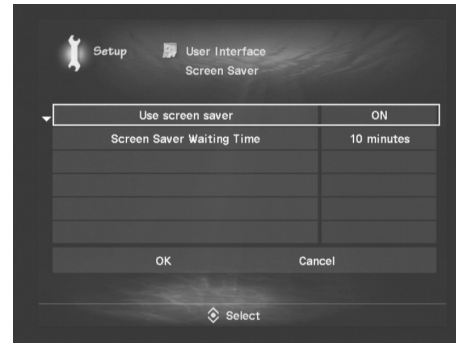

- 2 Change each parameter value as needed.

1 Use Screen Saver

Specify whether you use the screen saver. Select ON if you want the screen display to go off after the specified duration even while the MCX-2000 is active (factory setting). Select OFF if you want the screen display to go off only when the MCX-2000 enters sleep or standby mode. If you select ON, specify the duration with the following parameter (unavailable with OFF).

2 Delay before activation

Specify the duration of the screen display before the screen saver is activated (1 minute ~ 60 minutes; factory setting: 10 minutes).

- 3 When you select OK, the "Saving..." message is shown. The MCX-2000 afterward turns on and off the display as specified here.

NOTE When shipped, the MCX-2000 is set to activate the screen saver in 10 minutes. So, your TV monitor screen will automatically go off in 10 minutes after your last operation, even while the MCX-2000 continues working and doesn't enter sleep mode. When you operate the MCX-2000 at this point, the unit cancels the screen saver and displays the last shown screen.

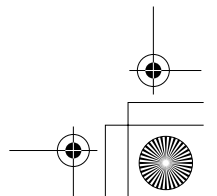
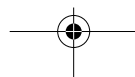
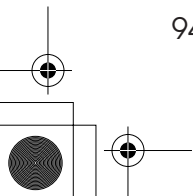

Language

- 1 From the User Interface menu, select Language.

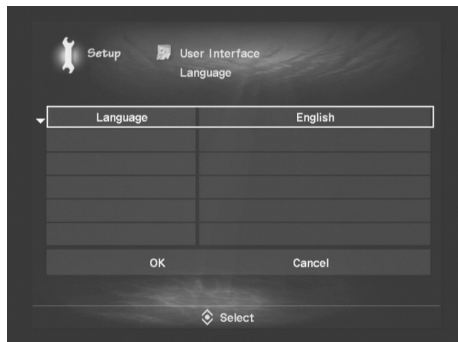

- 2 You have just one parameter, Language, for this setting. Select your preferred user interface language from the list.
- 3 When you select OK, the “Saving...” message is shown. When you return to the User Interface menu, confirm the language has changed. The MCX-2000 afterward uses the language specified here to show text messages in each operation screen (and the front panel display).

PS/2 Keyboard

- 1 From the User Interface menu, select Language.

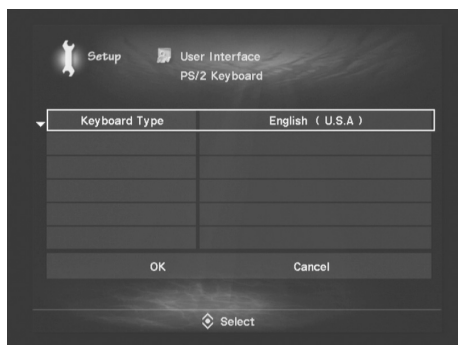

- 2 You have just one parameter, Keyboard Type, for this setting. Select from the list the language type of your PS/2 keyboard that's to be connected to the PS/2 port on the MCX-2000 front panel.
- 3 When you select OK, the “Saving...” message is shown. The MCX-2000 afterward recognizes a PS/2 keyboard connected to the PS/2 port, as specified here.

NOTE Be sure to connect your PS/2 keyboard while the MCX-2000 is in sleep or standby mode. If you connect it while the MCX-2000 is active, both units may be damaged. If your keyboard is already connected, the selected keyboard type immediately becomes valid. (You don't need to restart the MCX-2000.)

Selecting Playback Options

Select any desired audio source at any time, or program your own playlists with any combination of songs from the music archive — these are the best part of listening experience on the MCX-2000. You can use two playback options to make such listening experience, literally, more seamless.

- 1 Select Top Menu > Setup > Playback.

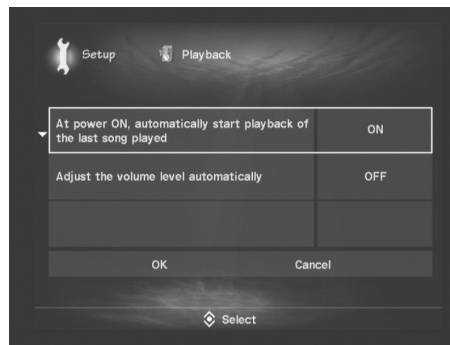

- 2 Change each parameter value as needed.

1 At power ON, automatically start playback of the last song played

With this parameter set to ON, the MCX-2000 automatically starts playing the last played (or selected) song when it wakes up from sleep or standby mode. With OFF, automatic playback doesn't occur (factory setting).

NOTE The last 'song' is namely the last 'audio source' played or selected. With this parameter set to ON, the MCX-2000 memorizes what was selected or played from which audio source. For example, if the last song was from the music archive, the MCX-2000 remembers which category, group or playlist the current song has been selected from. In fact, automatic playback will occur only when the same audio source is 'still' available when the MCX-2000 becomes active. So, automatic playback will not occur if you have set a second CD after listening the first and, without selecting or playing from the second, put the MCX-2000 in standby mode, and then awake the unit back again.

2 Adjust the volume level automatically

With this parameter set to ON, the MCX-2000 plays archived songs at an average volume level. You can use this parameter to compensate the volume difference of songs from different artists, albums or genres when playing them together. But, there may be cases a loud rock song is turned down or a calm classical tune becomes loud. With OFF, the MCX-2000 plays each archived song at its original volume level (factory setting).

NOTE Volume change with this parameter is valid only with playback on the MCX-2000, and this parameter setting doesn't affect streamed music to clients. (Each client has a similar parameter at Setup > Auto Level Control.)

- 3 When you select OK, the “Saving...” message is shown. The MCX-2000 afterward plays archived songs as specified here.

Selecting Recording Options

Regardless of its type, such as music CD, radio or external input, the MCX-2000 records or imports an audio source using common manners and formats. For optimum archiving, the MCX-2000 provides two recording options.

NOTE PCM is an uncompressed, raw audio format while MP3 is a compressed audio format. The MCX-2000 uses a CD-quality, 16-bit/44.1 kHz stereo PCM format, which creates digital audio data of about 10 megabytes per minute (1411.2 kbps data rate). Converting this raw audio into MP3 format, you can dramatically reduce the amount of data (approximately 1/5 to 1/10) maintaining the sound quality to some degrees.

1 Select Top Menu > Setup > Recording.

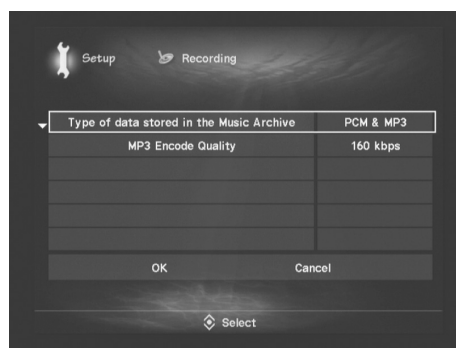

2 Change each parameter value as needed.

1 Type of data stored in Music Archive

Select PCM & MP3 to keep the recorded audio data in both formats (factory setting), or MP3 Only to keep compressed audio data only. The former setting keeps two different files per song, which virtually reduces the number of song you can keep on the MCX-2000 internal hard drive. The latter setting automatically deletes the PCM audio data after converting it into MP3 format, which saves the internal hard drive space. The MCX-2000 lets you make your original CD that compiles archived songs, which requires original PCM audio data. So, you're advised to select the former setting if you intend to create your own CD.

NOTE When you select to keep MP3 audio data only, it doesn't delete PCM data for existing archived songs. You can check which song has PCM data using the Information command from a song list screen's Submenu (audio format is PCM & MP3). To delete unnecessary PCM data for an archived song, use the Delete PCM Data command from the Submenu.

2 MP3 Encode Quality

Select the data rate used for MP3 conversion from 160, 256 or 320 kbps (factory setting: 160 kbps). Theoretically, the larger data rate is used, the higher sound quality is obtained. In reality, you should consider type and quality of the original PCM sound. If you select 320 kbps data rate for, say, a full-volume rock tune or a pop song with trebly notes and boom bass sounds, resulting sounds may be heard nearly the same with their 160 kbps versions, or may become noisier than original PCM versions. Higher data rates are rather suitable for, say, classical tunes with a wider dynamic range (volume difference between loudest and quietest sounds) or with ambience or subtle nuances.

NOTE A higher data rate produces more data per song, which virtually reduces the number of song you can keep on the MCX-2000 internal hard drive. (A 320 kbps MP3 song occupies twice as large space on the hard drive as a 160 kbps version of the same song.) In the System Information screen, you can confirm 'remaining recording time' based on the above two parameter settings (page 102). So, you may want to set temporary values here, confirm available recording time in the System Information screen, and finally determine suitable values here again. Otherwise, you can often change the above parameter values according to audio sources you're going to record.

3 When you select OK, the "Saving..." message is shown. The MCX-2000 afterward records audio sources as specified here.

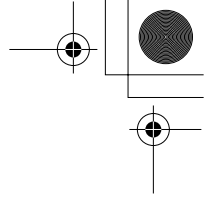

Using the Timer Playback

The MCX-2000 lets you program when your favorite music or radio station automatically starts playing — using the timer playback feature. It opens more possibilities to how to use the MCX-2000 and MusicCAST clients in your personal life (or even business). If you've programmed a playlist named Wake-up BGM, you can start every morning with songs in that playlist. If you don't want to miss a radio program, get prepared by registering the radio station at the specified time on the specified date to the timer playback list.

- 1 Select Top Menu > Setup > Timer for the following screen.

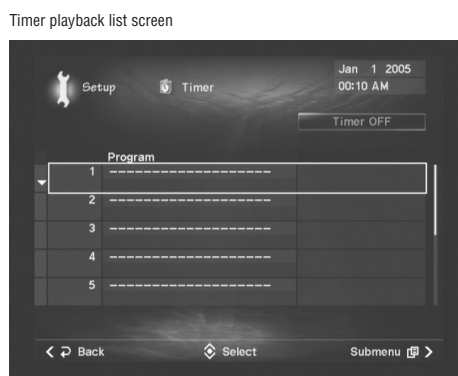

- 2 Move the selection (highlight) to a column to specify a program for timer playback, and then press the SELECT button on the remote control.



NOTE Because the MCX-2000 automatically selects and plays a program in the order of specified date and time, you don't need to care about the list position to register a program.

- 3 Select each parameter below and specify what and when you want to play. During programming, you should note the current date and time indication in the upper right corner of the screen.

1 Content, Playback

Select between Radio Preset and Playlist. According to your selection, use the Playback column to specify a radio station from the Presets list (page 60) or a playlist currently stored in the music archive. For Playback, select a target item using a dialog box that appears.

2 Activate when?, Date

Specify when you want to play the content specified above. When you select Once, also specify a specific date at the Date column. Other Activate options include Every Day and each day of the week (from Sunday to Saturday) for you to create a 'daily' or 'weekly' program. The Date column becomes unavailable (-----) when you select other than Once.

NOTE Of course, you cannot 'backdate' a timer program. So, if you specify July 1st on July 2nd, the program will start playback in one year later.

3 Start, End

Specify when you want to start playing the above program and then stop it. Based on your settings, the playback timer supports up to 24-hour continuous playback (when you set the same time value to both Start and End parameters). If you want to control the playback duration based on the content length (how many songs in the specified playlist, etc.), simply specify "--:--" for the End time. Then the MCX-2000 just triggers playback of the content specified above and removes the program from the program list if it has been specified as Once (one-time playback).

NOTE Time indication is based on the Time Display setting (page 92). If you're using 12-hour clock, always note the AM or PM display at the End parameter. If you want a one-hour timer playback, say, by specifying 9:00 to 10:00, you need to match AM or PM for both Start and End parameters. Otherwise, you may have a 13-hour continuous playback.

4 OK, Cancel, Clear

If you save this program, select OK. Selecting Cancel to abort all changes. Select Clear if you want to delete the current program. In any case, you will return to the timer playback list screen.

NOTE While you're editing (or simply viewing settings) in the timer program list screen, the MCX-2000 doesn't activate existing timer programs.

- 4 Confirm that a new timer program appears in the list screen. If required, continue creating other programs by repeating steps 2 to 3. You can create up to 10 timer programs for the MCX-2000.

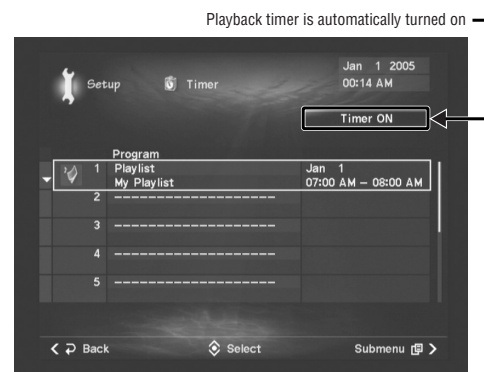

When you add a new timer program, the playback timer is automatically turned on. It keeps active as long as the program list contains programs. In addition, you can manually turn off or on the playback timer using the Timer command from the Submenu.



NOTE Timer ON/OFF commands activates and deactivates the playback timer itself, not individual timer programs. If you want to deactivate a specific timer program, open the timer program list screen to specify other playback time or delete the program by selecting Clear.

When the specified start time arrives, the MCX-2000 automatically starts playing the content, showing the Play information screen according to the content.

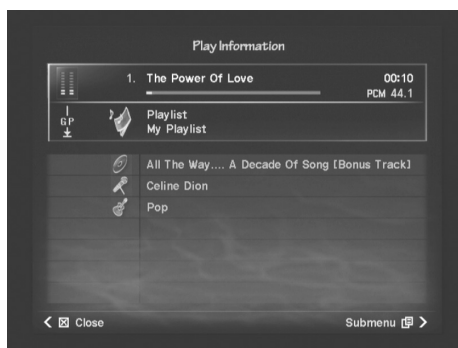

NOTE The specified content will continue playing until the specified end time arrives. If the content is a playlist shorter than the duration specified with the Start and End parameters, playback will stop without waiting for the end time. In this case, the program still remains in the timer program list. In addition, if you use any playback controls (start, stop, skip forward or backward, etc.) or change playback modes (repeat, random and broadcast) AFTER the MCX-2000 starts the timer playback, the timer playback is immediately canceled and the current program disappears right away from the program list. So, if you want to use playback modes along with the playback timer, set them BEFORE the timer starts playback. In this case, the MCX-2000 plays the content according to the current playback mode settings.

Using a Yamaha AV Receiver

If you're using one of supported Yamaha AV receiver products (page 102), you can connect it with the MCX-2000 for integrated operations including synchronized power on/off or processing the MCX-2000 audio signals using a suitable surround program on the AV receiver. For this application, you need additional cable connections as in the diagram below.

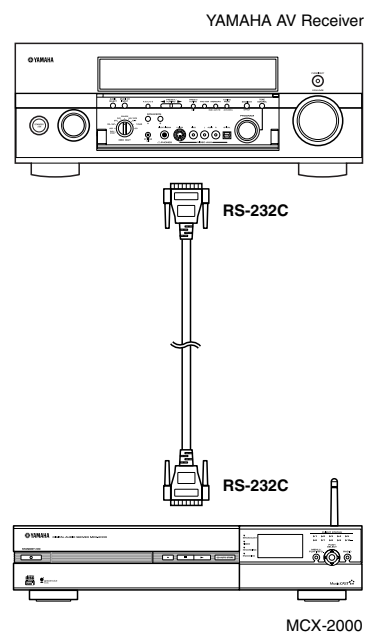

Use an RS-232C cross cable (sold separately) and connect RS-232C ports on both units. Also connect the MCX-2000 analog or digital output to suitable input jack(s) on the AV receiver. Note this jack name because you need to specify it for the Receiver Input parameter (see below).

- 1 Select Top Menu > Setup > YAMAHA AV Receiver for the following screen.

AV receiver setup screen

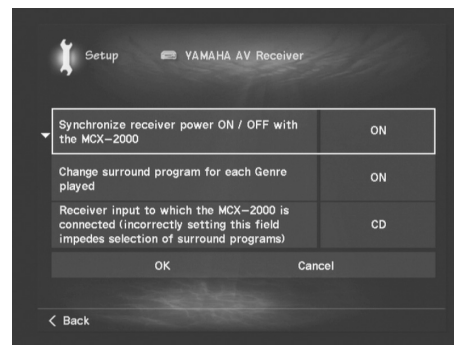

NOTE The above setup screen doesn't appear if you've not connected a supported Yamaha AV receiver to the MCX-2000. You will see an alert message instead.

2 Move the selection (highlight) to each parameter below and specify how you want both units to work together.

1 Synchronize receiver power ON/OFF with the MCX-2000

Select ON if you want the AV receiver power modes to match those of the MCX-2000. With this parameter enabled, the AV receiver wakes up from standby mode at the same time when the MCX-2000 wakes up and enters active mode. When the MCX-2000 enters sleep or standby mode, the AV receiver enters standby mode as long as its current input selection matches the Receiver Input value specified below (therefore, when the AV receiver is ready to play or has been playing audio signals from the MCX-2000).

NOTE You cannot control the MCX-2000 power modes remotely from the AV receiver.

2 Change surround program for each Genre played

Select ON if you want to change surround programs on the AV receiver according to what music is played on the MCX-2000. With this parameter enabled, the Set Surround Program command is newly available in the Submenu of the genre list screen (see below), where you can specify which surround program is applied to music from a specific genre.

3 Receiver input to which the MCX-2000 is connected

Select from the list an AV receiver input where you've connected the MCX-2000 audio output. This parameter is essential for integrated operations of the MCX-2000 and the AV receiver, so be sure to select the correct input name.

NOTE The MCX-2000 automatically recognizes the connected AV receiver and changes available values (AV receiver input names in the list).

3 Select OK to save your settings. Now the MCX-2000 is ready for synchronized operations with the AV receiver.

If you've specified to link the MCX-2000 genres to the AV receiver surround programs, open the genre list screen by selecting Top Menu > Library > Music Archive > Genres.

Genre list screen



Move the selection (highlight) to each genre, and then select the Set Surround Program command from the Submenu. Specify a surround program from the list for the current genre. (Available surround program names are varied according to the AV receiver model that's connected to the MCX-2000.)

4 To confirm integrated operations between the units, select the AV receiver's current input for the MCX-2000 (Receiver input) and then try:

- Pressing the STANDBY/ON button
- Selecting a song from the music archive

NOTE Automatic selection of a surround program is possible only when you select an archived song, but the selected surround program is continuously applied to other audio sources as long as they're output via the AV receiver. When the next (or previous) song is from a different genre, you may experience 'longer' silence between the songs, which comes from the AV receiver's surround program switching and is normal.

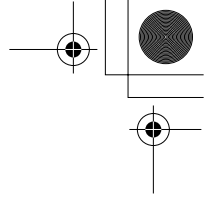

Managing an Existing MusicCAST Network

Network activities, such as streaming music to clients over a MusicCAST network or editing the music archive using a computer in a PC network, are very essential part of how you can use the MCX-2000 in your daily life. This section explains the MCX-2000 networking on the system side. Read this section when you want to know how to check the networking status of the MCX-2000 and each client and how to initialize network parameters for troubleshooting.

Checking the Network Status

You can use the Client Control screen to check the current status of each client, streamed music and MusicCAST networking. In addition to this, you can use the Status View screens to check basic network connections and the accurate IP address currently assigned to the MCX-2000.

- 1 Select Top Menu > Setup > Network > Status View.

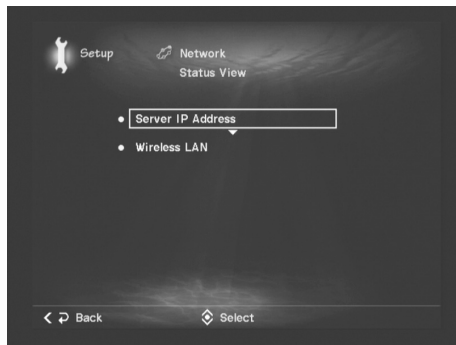

- 2 Select each item to see relevant information.

Server IP Address

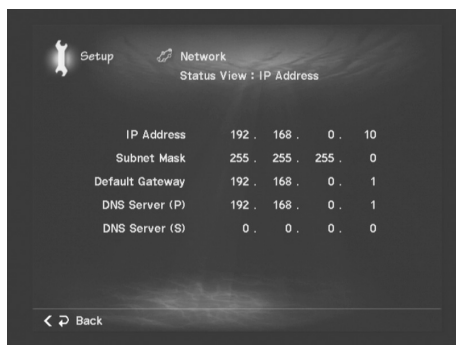

In this screen, you can confirm the current MCX-2000 IP address, subnet mask, gateway address and referent DNS servers (primary and secondary) that have been determined by the Setting Method (page 37) and other network parameter values (specified automatically or manually). When you want to access the MCX-2000 from a computer in your PC network, specify the IP address shown in this screen.

Wireless LAN

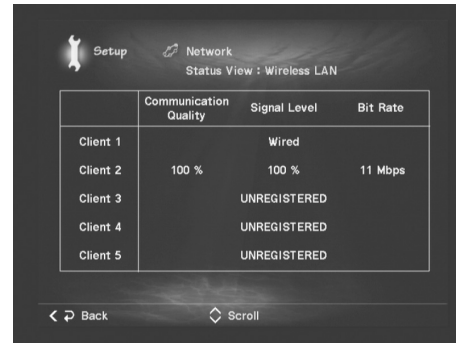

In this screen, you can confirm the networking status of each client in your MusicCAST network. Wireless clients might have a value of communication quality, signal level or bit rate (data rate; 11 Mbps at maximum) lower than shown above, because of how and where you placed clients. But, you don't need to care about each value unless you experience a problem such as interrupted playback of streamed music. If a wired client is shown with a 'disconnected' wired icon, you need to check its network cable. In each case, you should double-check the client status in the client list screen (page 87).

Initializing Network Settings

You don't need to change network parameters configured using Easy Setup (page 27) as long as the MCX-2000 and your MusicCAST network are working properly. You may, however, need to change the current network configurations of the MCX-2000 and clients if you move to a new house and change your network environment accordingly, or if you have reconfigured a PC network that the MCX-2000 is connected to. In such cases, you may want to initialize the MCX-2000 network parameters rather than manually edit each of them, and reconfigure the music server along with your MusicCAST network.

NOTE As long as you have automatically configured your MusicCAST network, reconfiguration of your PC network normally doesn't affect the MCX-2000 network connectivity, such as the MCX-2000 Internet access or PC accessibility to the MCX-2000. Most problems caused by network reconfiguration may occur if you have configured your MusicCAST network manually. In addition, you can add MusicCAST clients without changing MCX-2000 network parameters. New clients are easily registered to the MCX-2000 through Auto Configuration (page 31) and can immediately start playing streamed music via an existing MusicCAST network.

- 1 Select Top Menu > Setup > Network > Advanced Settings > Network Settings Reset.

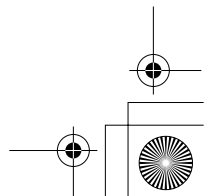
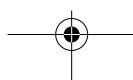
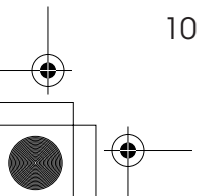
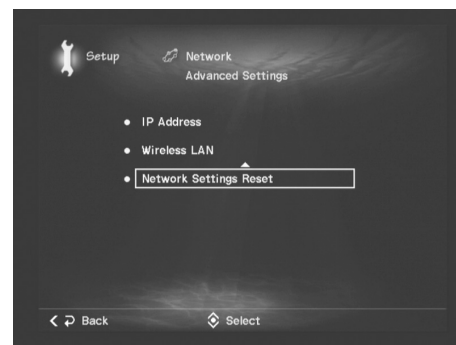

- 2 To initialize the MCX-2000 network parameters and recall their factory settings, select the Rest command from the Submenu.
- 3 A confirmation dialog box appears. When you select OK, the “Network rebooting...” message is shown and the MCX-2000 restarts itself.

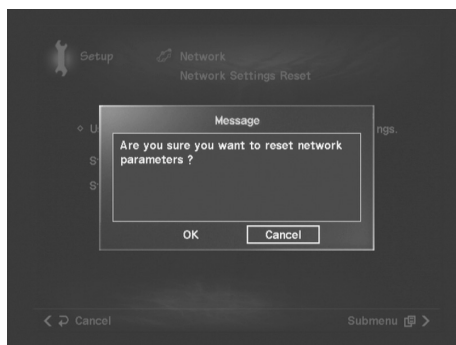

When the Top Menu screen is shown, start reconfiguration of your MusicCAST network. For detailed procedures, see the following sections.

- Using Easy Setup (page 27)
- Automatic Configuration of a MusicCAST Network (page 31)
- Manual Configuration of a MusicCAST Network (page 35)

Managing the MCX-2000 System

Not so popular as recording and playback of audio sources, editing archived song data or playlists, music streaming to clients, System Utilities provides essential functions and information required to maintain your MCX-2000. Select Top Menu > Setup > System Utilities for the following screen.

System Utilities menu

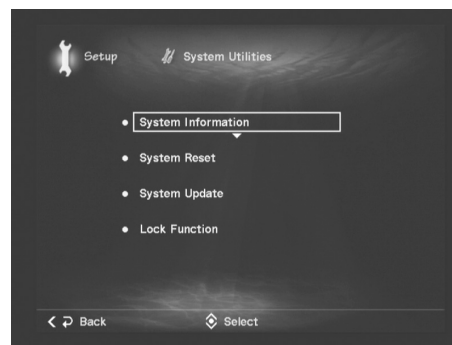

1 System Information

You can view the current activity and status of the MCX-2000 on the system side. Use this when you want to confirm the firmware version, usage of the internal hard drive, MP3 conversion activity of recorded audio sources, and supported Yamaha AV receiver products.

2 System Reset

You can access here a function to initialize all MCX-2000 parameters and recall their factory settings. Use this function when the MCX-2000 became unstable or when firmware update is applied to the unit. If you want to reconfigure your MusicCAST network because you got a new network environment (after move or relocation), initialize only network parameters, not the entire MCX-2000 system (page 100).

3 System Update

If you got the latest MCX-2000 firmware from Yamaha, you can use this function to update the unit.

4 Lock Function

Want to limit access to the MCX-2000? Then use this password-lock feature to prevent others from management operations on the MCX-2000. Lock function is especially useful if you're using the MCX-2000 in a public space.

Viewing System Information

- 1 From the System Utilities menu, select System Information.

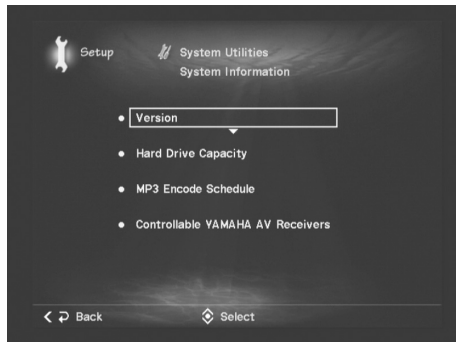

- 2 Select each item to see relevant information.

Version

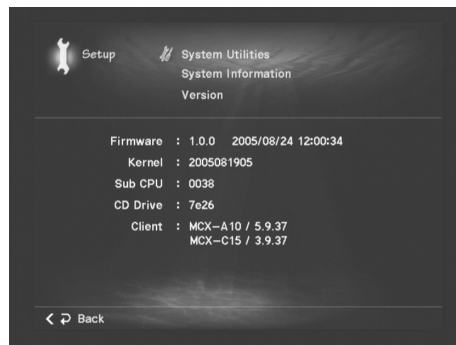

NOTE Each version number may be different from your MCX-2000.

In this screen, you can check version numbers of the MCX-2000 hardware and software components. Use this information when you confirm after firmware update or when you ask Yamaha for technical support.

Hard Drive Capacity



In this screen, you can view information about the 160GB hard drive inside the MCX-2000. At Hard Drive Size, you can know the currently used drive space as capacity and percentage to the entire drive capacity (less than 160GB after formatting). At Available Time, you can know the remaining drive space as available recording time if the recorded audio is kept in both PCM and MP3 formats, and kept only in MP3 format. Available recording time varies depending on the recording option settings (page 96).

MP3 Encode Schedule

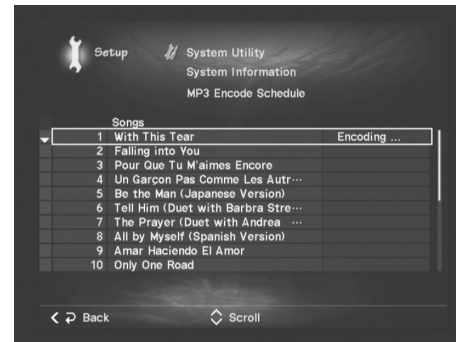

The ENCODING indicator on the MCX-2000 front panel lights up while the unit is converting the recorded audio into MP3 format. In this screen, you can view a list of song titles in MP3 conversion schedule. The first song in the list is currently in conversion process and shown with "Encoding" on the right of its title. Songs that finished MP3 conversion automatically disappear from the list, and the ENCODING indicator goes off when the list becomes empty.

NOTE Unlike recording process, you can interrupt conversion process by pressing the STANDBY/ON button to put the MCX-2000 in standby mode. During conversion process, the unit may automatically enter sleep mode, but doesn't automatically enter standby mode until it completes conversion of the scheduled songs. In addition, interrupted conversion process is automatically resumed when the MCX-2000 wakes up from standby mode. No operation is required.

Controllable YAMAHA AV Receivers

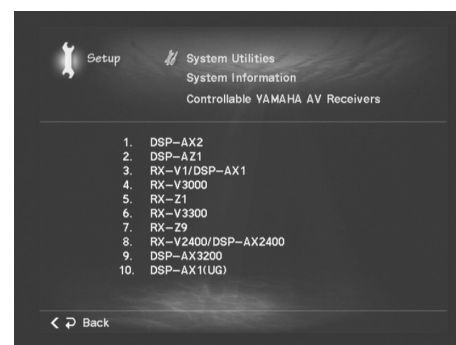

In this screen, you can know Yamaha AV Receiver products that you can integrate with the MCX-2000 using an RS-232C cross cable and relevant parameters (page 98).

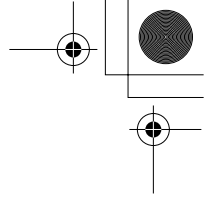

Resetting the MCX-2000 for Factory Settings

- 1 From the System Utilities menu, select System Reset.

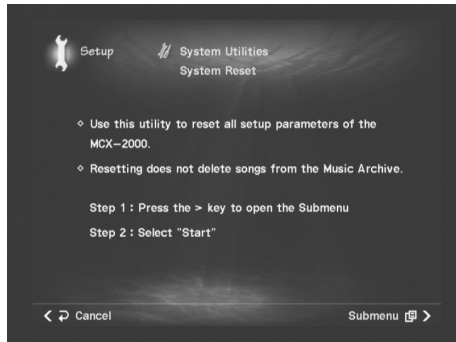

NOTE As shown in the screen, the purpose of resetting the MCX-2000 is to initialize all parameter values. When you reset the MCX-2000, any existing songs, playlists and bookmarks in your music archive are preserved, except for radio presets (initialized to factory settings). The system reset process also initializes the MCX-2000 internal clock, so note that existing timer playback programs are lost and initialized to factory settings. In addition, if you reset the MCX-2000 to reconfigure your MusicCAST network, see "Initializing Network Settings" (page 100). If you just want to manage your music archive (such as deleting unnecessary songs), see "Editing the Library" (page 75).

- 2 To start resetting the MCX-2000, select Start from the Submenu.

- 3 A confirmation dialog box appears. When you select OK, the "Resetting..." message is shown and the MCX-2000 restarts itself.

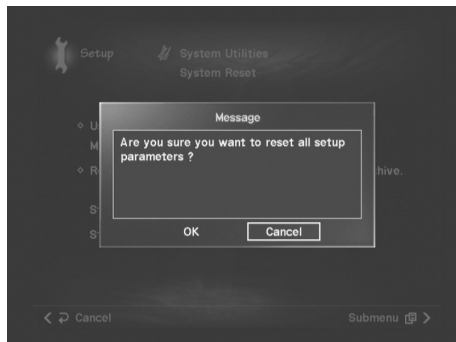

Another confirmation dialog box appears, telling that the internal clock and timer has been reset. When you select OK, the MCX-2000 automatically starts the Easy Setup process, showing the same screen shown when you turned on the MCX-2000 for the first time. Configure the MCX-2000 according to your environment, and newly create your MusicCAST network by registering MusicCAST clients (page 27).

Updating the MCX-2000 Firmware

Notes on Firmware update

When you update the MCX-2000 firmware, be sure to read the document that comes with the firmware update CD. This document contains the latest information on new features and any changes after updating the firmware, other important notices or additional procedure to the following update process.

- 1 Press the OPEN/CLOSE button on the remote control or on the front panel and open the CD tray. Set the firmware update CD with its label side facing up. Press the same button again to close the tray.

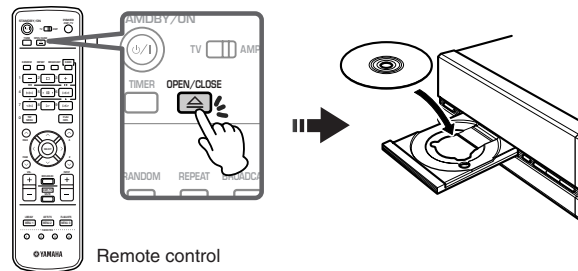

- 2 From the System Utilities menu, select System Update.

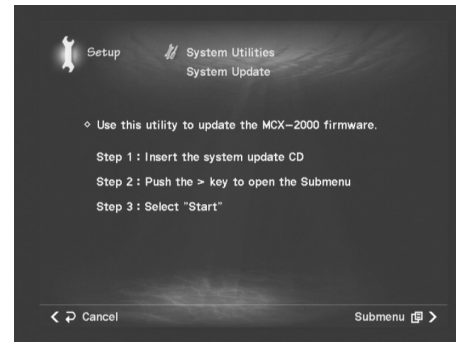

- 3 Update the MCX-2000 firmware according to the message shown in the screen. Normally, update process takes approximately 10 minutes.

NOTE Along with the MCX-2000 firmware update, you may need firmware update of each MusicCAST client. For details, read the document that comes with the firmware update CD.

Limiting Local Operations on the MCX-2000

- From the System Utilities menu, select Lock Function. The password entry dialog box appears, prompting you to enter a predefined password. Select OK after entry.

Password entry dialog box



For password entry, use the on-screen character palette or a PS/2 keyboard connected to the MCX-2000 front panel. Each password character will be shown with an asterisk (*).

NOTE When you use this function for the first time, enter "mcx-2000" in lowercase (factory setting).

- When you enter a correct password, the MCX-2000 shows the following screen where you can specify which operation is password-locked. Select Lock ON if you want to limit access to their relevant operations.

Password-lock selection screen



1 Setup

Limits access to each setup parameter available under Setup (Top Menu > Setup).

2 Edit function

Limits access to all edit functions available under Library (Top Menu > Library). These functions include any edit commands from Submenu (Edit, Delete, Change, Add, Remove, New, etc.) and the BOOKMARK button operations on the remote control.

3 Recording

Limits access to all recording features available under Recording (Top Menu > Recording) and the CD AUTO STORE button operations on the remote control.

4 CD tray open

Limits access to the built-in CD drive and the Open/Close button operations on the remote control and MCX-2000 front panel.

5 Password

Define your own password to lock off functions specified above. Your password must be up to 14 characters (case sensitive).

NOTE If you forgot your password, select Lock Function from System Utilities (step 1 above). Enter all uppercase "MCAST" in the password entry dialog box, and then select OK. This resets the password to its factory setting (mcx-2000), and you can enter the password-lock selection screen. In addition, the password will also be reset if you reset the MCX-2000 (page 103).

Compatible Media (CD/CD-R/CD-RW)

Discs that can be used for recording on this unit

Be sure to use only CD-R and CD-RW discs made by reliable manufacturers.

CD-R and CD-RW digital audio discs that display either of the following marks can be used with this unit.



For consumer
For consumer use
For music use only

Discs that can be used for recording

- CD-R discs can only be recorded on once, and the recorded material cannot be erased.
- CD-RW discs can be recorded on, have the recorded material erased, and then recorded on again any number of times.

Discs that cannot be used for recording on this unit

- Discs bearing marks other than those shown above.
- Discs intended for recording computer data.
- Discs intended for professional use or labeled "FOR PROFESSIONAL USE ONLY".

79-minute CD-R disc

The actual recordable time of the CD-R disc with "80" written on its package is 79 minutes 57 seconds. This manual refers to such CD-R disc as "79-minute CD-R disc".

Finalization of CD-R/CD-RW discs

To play back CD-R discs on a standard CD player and CD-RW discs on CD-RW-compatible players, the server automatically perform the process known as "finalization". In the finalization process, the Table of Contents (TOC) is written onto the discs.

Finalized CD-R discs

- CD-R discs can be played on a standard CD player.
- Further recording onto CD-R discs is not possible on this unit.
- Some CD players may not play back the finalized CD-R discs properly due to differences in the playback systems of different manufacturers.

Finalized CD-RW discs

- CD-RW discs cannot be played on a standard CD player. CD-RW discs can be played back on CD-RW-compatible players such as this unit.

Erasure or loss of data

Yamaha and suppliers accept no liability for the loss of data written on the HDD and CD-R or CD-RW discs, or any problems caused as a result of using this unit. As a precaution, it is recommended that the discs are tested after they have been recorded on. Furthermore, under no circumstances do Yamaha and suppliers guarantee the reliability of the discs.

Discs that can be played back

In addition to CD-R and CD-RW digital audio discs described above, commercially available pre-recorded CDs bearing the marks shown below can also be played on this unit.



NOTE If you use CDs that do not meet the above CD standards, this unit may not operate properly.

Playback on DVD players

Before playing back finalized CD-R or CD-RW discs on a DVD player, please check whether the DVD player is compatible with CD-R or CD-RW discs or not. Refer to the owner's manual of the DVD player for more information. CD-R or CD-RW discs cannot be played on a DVD player that is not compatible with CD-R or CD-RW discs.



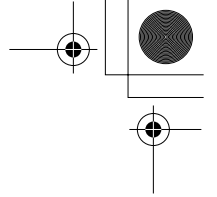

IMPORTANT

Please check the copyright laws in your country to record from records, CDs, radio, etc. Recording of copyright material may infringe copyright laws.



Handling of discs

Heed the following notes on handling of discs to avoid any cause for a recording failure, a loss of the recorded data, or a malfunction of this unit.

- This compact disc recorder is designed for use with CDs (including 8 cm [3"] discs) bearing the , ,  or  marks only. Never attempt to load any other type of disc into this unit.
- CDs are not subjected to wear during play. However if the disc is handled improperly, damage may be created on the disc to adversely affect the disc's play.
- When writing on the label side of CD-R or CD-RW discs, use an oil-based felt-tipped pen.
- Do not use cleaning discs or warped discs. All of these could damage this unit.
- Although playback of CDs is generally not affected by small particles of dust or fingerprints on their playing surface, dust, fingerprints, small scratches and direct sunlight on the recording surface of a CD-R or CD-RW disc may make recording impossible. Therefore, for optimal performance of the recorder and for long-term enjoyment of your CD collection, handle discs correctly as outlined in the following guidelines.

- 1 Hold discs by touching only the edges or center hole.
- 2 When a disc is not currently being used, remove it from the recorder and store in an appropriate case.
- 3 With proper disc maintenance, cleaning should not be necessary. However, should cleaning be required, wipe by using a clean, dry cloth. Do not wipe with a circular motion; wipe straight outward from the center.

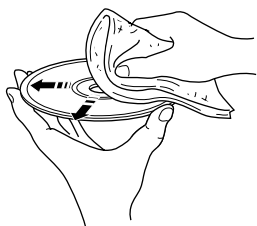

- Do not try to clean the disc's surface by using any type of disc cleaner, record spray, antistatic spray or liquid, or any other chemical-based liquid, because such substances might irreparably damage the disc's surface.
- Do not expose discs to direct sunlight, high temperature, or high humidity for a long period of time, because this might warp or otherwise damage the disc.



To prevent a malfunction of this unit

- Do not use any non-standard shaped CDs (heart shaped, flower shaped, etc.) available on the market, because they are off balance in their weight. If a non-standard shaped CD is loaded into this unit, it may create problems such as improper playback, opening of the disc tray, usual noise, and this unit's failure.

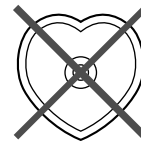

- Be sure to use a felt-tip pen or similar writing tool when writing on the label side of the disc. Do not use a ballpoint pen, pencil, or other hard-tipped writing tool, as these may damage the disc and may adversely affect further recording on the disc.
- Do not use discs with glue left on their surface. They may get stuck in this unit or create damage to this unit.
- When using an 8 cm (3") disc, do not place a normal 12 cm (5") disc on top of it.
- Do not use discs printed with commercially available label printers.

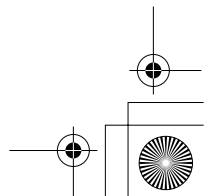
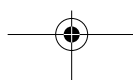
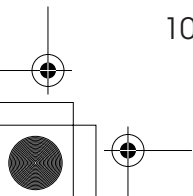
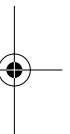

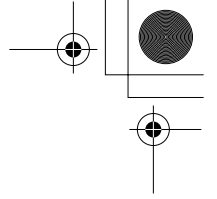

About Digital Recording with MusicCAST

Rules of Digital Recording

SCMS-Serial Copy Management System

As a digital audio component, this unit conforms with the Serial Copy Management System (SCMS) standards. The Serial Copy Management System restricts copies made by recording digital signals to first-generation copies only. The digital program sources that have been recorded cannot be digitally recorded again.

There are two rules as follows:

Rule 1

Digital sources such as commercially available CDs can be copied digitally onto other recordable digital media with this unit (a first-generation digital copy). However, the first generation digital copy cannot be copied digitally any further.

Rule 2

The source that was recorded via the **ANALOG IN** jacks can be copied digitally onto other recordable digital media (a first-generation digital copy). However, the first generation digital copy cannot be copied digitally any further.

The server automatically detects whether it is able to store a CD digitally on its hard disk drive (the default setting is to store digitally).

Source sampling rate conversion

- Digital input of this unit supports sampling frequencies of 32 kHz, 44.1 kHz, 48 kHz, and 96 kHz. This unit converts these inputs to 44.1 kHz, 16-bit digital signals and records them onto the HDD, or a CD-R or CD-RW disc.
- Analog input is also converted to the same digital signal to be recorded.
- This unit outputs the signals at the sampling frequency of 44.1 kHz, 16-bit from its digital output.

Recording of non-audio signals

- This unit is designed exclusively for recording audio signals. Recording is only possible for audio signals.
- When a CD with CD-TEXT is recorded from an external CD player, CD-TEXT cannot be copied even if it is not copy protected. To copy CD-TEXT, select the CD-TEXT option when you store a CD on the hard disk drive of the server.
- If the digital signals contain graphic data such as CD graphics, the non-audio signals will not be recorded.
- It is not possible to record from non-audio sources such as CD-ROM or DVD.
- For the above reasons you may encounter difficulty storing CD-TEXT. We recommend using the internal Gracenote CDDB Music Recognition Service as a source of information when storing CDs.

Notes on the MusicCast system

Number of recordable discs and tracks and their length

- The server can record up to 99 songs to a CD-R or CD-RW.
- The server can store up to 1000 songs in an album.
- Once the maximum number of tracks has been recorded to a disc or album, no further recording is possible, even if space for recording is available.
- The minimum length of one track is 4 seconds. The maximum length of one track is 99 minutes 59 seconds for the HDD.
- The MusicCAST can store up to 10000 albums and 65,000 songs. However the number of albums you can create is also limited by the availability of space on the hard disk drive.
- When recording on a CD-R or CD-RW disc, a 2-second silence is automatically added to the beginning of the first track. Therefore the actual total recordable time will be 2 seconds shorter than the total recordable time of a CD-R or CD-RW disc.

Troubleshooting

Refer to the chart below when the MCX-2000 doesn't appear to be functioning correctly. If the problem you are experiencing is not listed below or if the instructions listed next to the problem don't help, set the MCX-2000 to standby mode, disconnect the power cable from the AC outlet, and contact the nearest authorized YAMAHA dealer or service center.

Symptom	Cause	Remedy
The MCX-2000 does not turn on when you press STANDBY/ON.	The MusicCAST power plug is not inserted into the AC outlet correctly.	Insert the power plug firmly into an AC outlet.
The MCX-2000 does not play CDs.	There is condensation on the laser pickup lens.	Turn off the power, wait 20 or 30 minutes, and then turn power on again.
	The CD is loaded upside-down in the disc tray.	Load the CD in the disc tray label side up.
	The CD is dirty.	Clean the CD.
The MCX-2000 cannot store CDs.	There is no space remaining on the hard disk drive.	Delete songs that you do not need, to make space on the hard disk drive.
	The CD-R/RW loaded in the MCX-2000 is dirty or scratched.	Clean or replace the CD-R/RW.
The MCX-2000 cannot record songs to a CD-R/RW.	The CD-R/RW loaded in the MCX-2000 already has data recorded on it.	Load a blank audio CD-R/RW into the disc tray.
	The CD-R/RW loaded in the MCX-2000 is dirty or scratched.	For CD-Rs, replace the CD-R with a new disc. For CD-RWs, initialize the disc and then record it again.
The MCX-2000 will not record songs longer than 100 minutes in duration on its hard disk drive.	The maximum length for a single song is 99 minutes and 59 seconds.	The MCX-2000 begins recording a new song after recording for 99 minutes and 59 seconds, regardless of the recording mode set
There is a pause starting playback of songs when the MCX-2000 is connected to an amplifier via a digital connection.	The MCX-2000 is playing back tracks recorded with differing emphasis settings.	Connect the analog outputs on the MCX-2000 to the amplifier.
CD-R/RW made on the MCX-2000 will not playback correctly on other CD or DVD players.	The CD or DVD player you are using is not capable of playing CD-R/RW.	Use a CD/DVD player capable of playing back CD-R/RW.
Sound from the MCX-2000 skips during playback.	Either the MCX-2000 or the source component is being shaken or vibrated.	Change the location of your components (unless the source recording was affected by vibrations or shocks).
	The CD is dirty.	Clean the disc.
The MCX-2000 does not operate normally.	The system controller has stopped.	Press and hold the STANDBY/ON button on the front panel for at least 15 seconds.
You can hear the sound of a fan coming from the MCX-2000.	The internal temperature of the MCX-2000 is rising.	The internal fan in the MCX-2000 activates when the internal temperature of the unit rises. This is not a malfunction.
Auto Configuration does not function correctly.	The network settings are incorrect.	Check the network settings.
	Surroundings are interfering with wireless network signals (for wireless connections only).	Change the location of MusicCAST components.
		Try using a different wireless network channel.
	Use wired network connections to connect MusicCAST components.	
Either the MCX-2000 or the MCX-A10 is not set to Auto Configuration mode.	Check the connection procedure and try again.	
The client is storing or recording songs.	Try again when recording is complete.	
You cannot start playback on the clients.	Configuration has not finished.	Carry out the Auto Configuration process.
	The network settings are incorrect.	Check the network settings.
	There are no songs which the MCX-2000 has finished encoding to MP3 format in the MCX-2000 library.	Wait until MP3 encoding is complete.
	Surroundings are interfering with wireless network signals (for wireless connections only).	Change the location of MusicCAST components.
		Try using a different wireless network channel.
Use wired network connections to connect MusicCAST components.		

Symptom	Cause	Remedy
There are skips or pauses during playback from the clients.	Surroundings are interfering with wireless network signals (for wireless connections only).	Try using a different wireless network channel, or use a wired network connection.
	The network is extremely congested (for wired network connections).	Place your MusicCAST components under a different subnet.
	Thick walls, televisions, microwave ovens, and devices such as cellular telephones that transmit radio signals may interfere with or block the wireless network signals from the MusicCAST system.	Relocate your client, or use a wired network connection to connect the client to the MCX-2000.
The server does not appear to find the correct album, or finds no albums at all, when you attempt to store an album.	The MCX-2000 is set not to access the Gracenote CDDB	Set the MCX-2000 to access the Gracenote CDDB.
	The MCX-2000 is only accessing its built-in Gracenote CDDB.	The built-in Gracenote CDDB database on the MCX-2000 may not contain data on some CDs. Set the MCX-2000 to access the Gracenote CDDB via the Internet (note: connect the MCX-2000 to the Internet first).
	The MCX-2000 cannot access the Internet-based Gracenote CDDB service even though it is set to do so.	Check the network settings.
The MCX-2000 does not display the data it obtains from the Gracenote CDDB correctly.	The MusicCAST supports languages in compliance with ISO-8859-1 standards. Data that is not in accordance with these standards does not display correctly.	Edit the text manually.
The MCX-2000 stops storing songs prematurely.	The hard disk drive is full.	Delete any songs you do not need, or delete PCM versions of songs.
	The MCX-2000 is set to Synch. Recording for signals from external inputs.	Store songs manually.
You are unable to select some songs for recording to the CD.	You are attempting to select songs for which only MP3 files exist.	The server cannot record MP3 files to CD.
You cannot enter the CD creation or CD storing screens after recording from an external device.	The MCX-2000 is already recording something other than the item you are attempting to select.	Stop all other recording.
Volume levels for the analog inputs are too low or too high (distorted).	The current analog input level setting is not appropriate.	Use the "REC Level" in the Submenu to set an appropriate recording level.
You cannot change from external input to another playback option.	The MusicCAST is recording from an external input.	Stop recording from an external source.
Playback changes from the external input for no apparent reason.	Another operator is changing sources.	Stop the operator from changing sources.
The MCX-2000 does not control the AV receiver correctly.	You are using a "straight" RS-232 cable.	Use a "cross" cross-type RS-232 cable.
	You have not set the MCX-2000 to change AV receiver settings.	Set The server to change AV receiver settings.
	The AV receiver 6 channel input parameter, is set to "ON".	Set the AV receiver 6 channel setting to "OFF".
The correct time is not displayed.	The power cable has been disconnected from an AC outlet for more than 6 hour.	The MCX-2000 holds backup data for no longer than 6 hour after the power cable is disconnected from the AC outlet. Disconnecting it for longer than this will reset the internal clock. Reconnect the power cable within one minute of disconnection.
There is a gap between MP3 songs.	MP3 songs are encoded individually.	This is not a defect in the MCX-2000.
There is no sound from analog inputs.	The external component is not connected correctly.	Connect the component correctly.
Playback is delayed or starts at the wrong place on the CD.	The CD is scratched or dirty.	Check the CD, and replace it if necessary.
The speakers emit a humming sound.	Connect your components correctly.	Connect the stereo pin cables firmly.
The remote control does not appear to function correctly.	The batteries in the remote control are exhausted.	Replace both batteries with new ones.
	You are attempting to operate the MCX-2000 from too far away. You are not aiming the remote controller at the MCX-2000.	Use the remote control within a 60 degree arc, no further than 6 meters from the MCX-2000.
	Bright light (such as sunlight or light from a fluorescent lamp) is striking the remote control sensor.	Relocate the MCX-2000 so that no bright light strikes the remote control sensor.
Playback on the clients skips or pauses.	The current state of your network (wired or wireless) is preventing smooth playback.	Try stopping playback and/or recording.
	The MCX-2000 is doing too many tasks, such as streaming to multiple clients (including streaming PCM data), recording or importing music, editing a name or title using the PS/2 keyboard, etc., at the same time.	Reduce simultaneous tasks and 'unload' the MCX-2000.

Symptom	Cause	Remedy
Playback from a wireless client is interrupted or unstable.	Audio streaming from the MCX-2000 is affected with a device that uses the same 2.4 GHz radio signal range (such as microwave oven, wireless handset, or other wireless access point).	Relocate the client or connect it to the MCX-2000 using a network cable.
Little 'longer' silence between songs during PCM audio playback (streaming).	Volume level adjustment on the MCX-2000 or surround program selection on the connected AV receiver is occurring between songs.	Turn off the relevant features.
Retrieved song data is incorrect even when "Internet database" is specified for CD Lookup.	The MCX-2000 refers to the 'cached' song data before accessing the online CDDB database.	Use the CDDB Info command from Submenu to forcibly retrieve the latest song data from the online CDDB database. This command is available in Music Archive or CD playback/import screen.
Cannot connect to the MCX-2000 from a wireless computer.	Normal. Wireless access point (WAP) feature built into the MCX-2000 is only available to MusicCAST clients.	Attach another WAP device to your network to access the MCX-2000 from a wireless computer.
Internet radio is unavailable.	Firewall on your router device is shutting out incoming Internet radio streams.	Allow radio streams to pass through the firewall by specifying their TCP port numbers for allowed incoming data. Typical TCP port numbers used for Internet radio are 8000, 8210, 8765, etc., and are often described in radio station URLs. Note these changes degrade your firewall security levels.
	Misconfiguration of network settings.	Confirm your network settings and Internet access is available to the MCX-2000.
Requesting an Internet radio station from a client returns an "unavailable" message.	Normal. The MCX-2000 doesn't stream Internet radio programs to individual clients.	Internet radio programs are broadcast to all clients specified on the MCX-2000. Use the Broadcast feature.
Network content is unavailable.	Supplied server software isn't installed on your computer.	Install the server software on your Windows PC. This software is contained in the supplied CD-ROM.
	Misconfiguration of network settings.	Confirm your network settings. Your target PC and the MCX-2000 must be in the same network. Check both devices have the same network address and subnet mask values.
Radio Frequency or channel on the MCX-2000 is unexpectedly changed.	A different radio frequency or channel has been selected from the client(s).	Radio is a shared audio source between the MCX-2000 and its clients. If you want to select it only from the MCX-2000, prevent client-side operations using the Lock feature.
External input source (Digital or Analog) is unexpectedly changed.	A different external input source has been selected from the client(s).	External input is a shared audio source between the MCX-2000 and its clients. If you want to select it only from the MCX-2000, prevent client-side operations using the Lock feature.
Song titles correctly shown on the MCX-2000 are incorrectly shown on the client.	MusicCAST clients cannot display some European language characters and Japanese Kana-Kanji characters at the same time.	—

Glossary

This manual uses a number of terms that, though not specific to the MusicCAST system, are not in general everyday use. In addition, some terms are used in a slightly unusual context. These words are listed alphabetically and in context below, along with an explanation of their meaning.

Playback

Album

A collection of songs in the MusicCAST database assigned to a particular artist, and given a name. Each album is assigned to an artist. By default, each CD you store in the server stored as an Album.

Artist

The item in the MusicCAST database to which albums are assigned. The artist of any CD you store in the MusicCAST is stored as the artist to the corresponding album (see album above).

Bookmark list

A list of songs you have designated for easy retrieval.

Genre

The music type to which the albums stored in the server are assigned. Examples include Jazz, Rock, and Classical.

Group

The category which you are operating your MusicCAST component in. For example, if you play an album without selecting a song, then you are operating within the "album" category. If you play a genre without selecting a song, you are operating within the "genre" category.

Playlist

A list of songs you designate using the server for playback in a given sequence.

Song

A single continuous track, equivalent to a single track from a CD, cassette, or other source, stored on the server.

Recording

CDDB

The CDDB (Gracenote CDDB Music Recognition Service) is a database which you can access to gain information on the songs, artists, genre, and album names for music CDs.

CD-TEXT

Data encoded on some CDs which contains information on its song titles, album, artist, and genre names.

Encoding

The process of converting PCM data stored from a CD into MP3 data.

MP3 format

A data format used to store music on the hard disk drive in the server. MP3 files take roughly one tenth of the space that PCM files take to store the same song. However, sound quality is not as good as that of PCM files, and the server cannot record MP3 files to a CD-R.

PCM format

A data format used to store music on the hard disk drive in the server. PCM files provide CD quality audio playback but require a lot of space on the hard disk drive.

Storing

Copying the tracks on a CD onto the hard disk drive in the server.

Network connections

Connections

The links between the components in your MusicCAST network which allow them to exchange information. MusicCAST components can make both wired and wireless connections.

DHCP

A system of automatically assigning IP addresses to components in a LAN. A server component running a DHCP service assigns an IP address to components when they are switched on.

DNS

An abbreviation for Domain Name System.

DNS server

A computer that is running a DNS service (see DNS).

ESS ID

The ID of the channel that your MusicCAST system uses to transmit data when using wireless connections.

Gateway

The IP address of the component on a network through which other components on the same network connect to the Internet.

IP address

Four 3 digit numbers that together make up a unique identity number used by a component connected to a network.

Network

A collection of electronic components which share data and resources with one another.

Network cable

A cable for connecting two components on a Local Area Network (LAN).

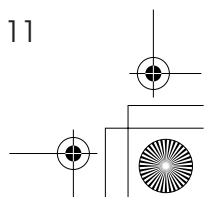
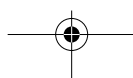
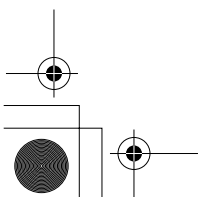
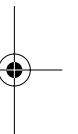
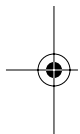

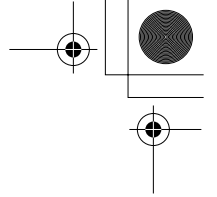
**Subnet mask**

A number identifying the group within a network to which a particular component belongs.

TCP/IP

An abbreviation of Transmission Control Protocol/Internet Protocol, a system of coding information that allows it to be shared efficiently on a network.

WEP

An abbreviation of Wired Equivalent Privacy. This system encrypts data transferred between the components on a wireless network. Components with the same encryption key can share data with each other, but components without this key cannot.

Wireless LAN

A network utilizing weak radio signals to share data between components.

Wired LAN

A network utilizing network cables to share data between components.

Hardware

CD

An abbreviation of Compact Disc. A small plastic disc 12 cm (4.8 in) in diameter encoded with pre-stored data.

CD-R

An abbreviation of Compact Disc Recordable. A small plastic disc identical to a CD in appearance, onto which a device such as the server can record data. The server can only record to Audio type CD-R media.

CD-RW

An abbreviation of Compact Disc Re-writable.

Client

See "Digital Audio Terminal".

Controller

The device on the front panel of the server and client used for entering data and navigating through the menus contained in these two components.

Digital Audio Server

The component in the MusicCAST system that you use to store and playback songs. Other components in the MusicCAST system obtain song data from the server.

Digital Audio Terminal

The component in the MusicCAST system that allows access to songs stored in the server for playback at a distance. Up to 7 Digital Audio Terminals (clients) can access the server at once.

Front panel

The panel on the front of the server and client with the LCD display, controller and various control keys are located.

Hard disk drive

The component within your server used to store the audio material from your CDs as data. Hard disk drive capacity is expressed in gigabytes, with a larger number denoting more storage capacity.

Remote control

A handheld device for operating your MusicCAST components from a distance.

Server

See "Digital Audio Server".

Software

Database

The organized collection of data stored on the hard disk drive in your server. The data is arranged in a logical manner so that it is easy to access, manage, and update.

Menu

A display consisting of a multiple choice style list of options that you can choose from. Menus are displayed on the on-screen displays of the client and server.

On-screen display

The LCD display on the client or the display output to a TV or monitor connected to the server.

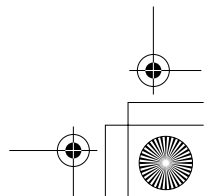
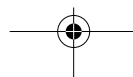
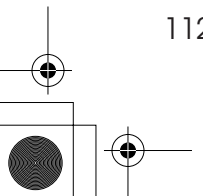
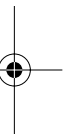

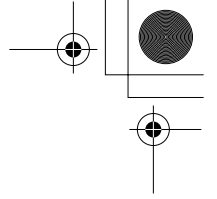

Specifications

■ **Audio Performance**

- Frequency response..... 20 to 20,000 Hz, ±0.5 dB
- S/N ratio (EIAJ)
 - Playback..... 100 dB
 - Recording..... 92 dB
- Total harmonic distortion (1 kHz)
 - Playback..... 0.004 %
 - Recording..... 0.006 %
- Dynamic range
 - Playback..... 100 dB
 - Recording..... 92 dB

■ **Laser Diode Properties**

- Material GaAlAs
- Wavelength 780 to 787 nm
- Pulse durations and max. output at the objective lens of the laser pickup unit
 - DC erase mode Max. 12 mW (Continuous)
 - Write mode..... Max. 70 mW (Max. Cycle 98 ns, Min. Cycle 27 ns at Max. Speed)

■ **Inputs**

- ANALOG IN
 - Input sensitivity 150 mV/22 kΩ

■ **Outputs**

- ANALOG OUT
 - Standard output level (1 kHz, 0 dB)..... 2.0±0.5 Vrms
- VIDEO OUT
 - Signal level
 - Video 1Vp-p/75 Ω
 - S Video
 - [U.S.A. and Canada models]..... Y: 1 Vp-p/75 Ω, C: 0.286 Vp-p/75 Ω
 - [U.K., Europe, and Australia models]..... Y: 1 Vp-p/75 Ω, C: 0.3 Vp-p/75 Ω
- PHONES
 - Standard output level (Input -20dB, 150Ω load) 430 mV/150 Ω

■ **Storage**

- Hard disk drive 160 GB

■ **Network**

- LAN interface Ethernet 10/100 Base-T
- Wireless network interface..... IEEE 802.11b/g

■ **General**

- Power supply
 - [U.S.A. and Canada models]..... AC 120 V, 60 Hz
 - [U.K., Europe, and Australia models]..... AC 100-240 V, 50 Hz
 - Power consumption..... 30 W
 - Power consumption in standby mode..... ≤ 5W
- Operating environment
 - Temperature +5 to 35°C
 - Humidity 30 to 90 % RH (No condensation)
- Dimensions (W × H × D) 435 × 95.5 × 408.5 mm (17-1/8" × 3-3/4" × 16-1/16")
- Weight 6.6 kg (14 lbs 9 oz)

Specifications are subject to change without notice.

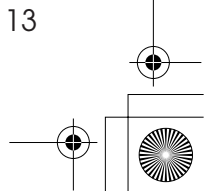
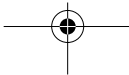
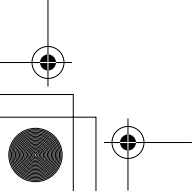
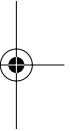

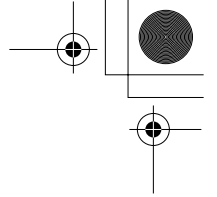

Index

Numerics

10/100 indicator10

A

AC IN socket9
 Access Timeout93
 Album111
 Alphabetical index search buttons11
 ANALOG IN jacks (stereo)10
 Analog Input63
 ANALOG OUT jacks (stereo)10
 Artist111
 Auto Lookup93
 automatic configuration30

B

Back Panel9
 Batteries16
 Bookmark50
 BOOKMARK button11
 Bookmark list111
 BROADCAST button12
 BROADCAST indicator8

C

CD46, 112
 CD AUTO STORE button7
 CDDB111
 CD-R112
 CD-RW112
 CD-TEXT53, 111
 Changing Song Attributes77
 Channel38
 Channel Search57
 Character Palette75
 Client112
 CLIENT STATUS indicators7
 Connections111
 Controllable YAMAHA AV Receivers102
 Controller112
 Create an original CD66
 Creating a Playlist82
 Cursor controller8, 11

D

Database112
 Database Location93
 Date and Time28, 91
 Default Gateway37
 Deleting the PCM Data80
 DHCP24, 41, 111
 DHCP server24
 Digital Audio Server112
 Digital Audio Terminal112
 Digital Input63
 Direct Access57
 Disc tray7
 Display7
 DNS111
 DNS server35, 111
 DNS Server (P)37
 DNS Server (S)37

Duplicate a CD66

E

Easy Setup27
 Editing a Playlist83
 Editing Titles77
 Encoding111
 ENCODING indicator8
 ESS ID38, 42, 111

F

Fan opening9
 FAVORITES 1~4 buttons11
 FM54
 FM ANT terminal9
 Front Panel7
 Front Panel Display94

G

Gateway35, 111
 Genre111
 Getting the most out of the Presets List61
 Gracenote CDDB53
 Group50, 111
 Group selection buttons12

H

Hard disk drive112
 Hard Drive Capacity102

I

ID3 Tags53
 Importing a Music CD Automatically68
 INPUT buttons11
 Inputs46
 Internet access via a PC network30
 Internet Radio54
 IP Address37, 41
 IP address111
 IP addresses35
 IR transmitter11

L

LAN (Ethernet) port10
 Language95
 LEVEL knob8
 LINK/DATA indicator10
 List View48

M

MCX-2000 Menu Tree22
 Menu112
 MENU 1~3 buttons11
 Menu Operation Basics19
 MENU/PLAY INFO. button8
 MP396
 MP3 Encode Quality96
 MP3 Encode Schedule102
 MP3 format111
 Music Archive46

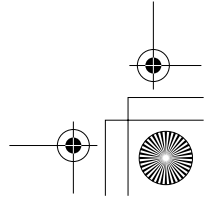
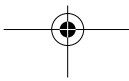
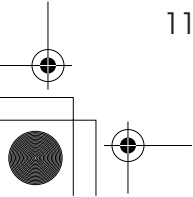
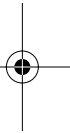

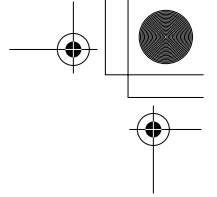

MusicCAST System Configuration28
 MusicCAST-only Network25
 MUTE button11

N

Network111
 Network cable111
 Network Configuration29
 Network Connection (stand-alone, without clients)28
 Network Connection (with clients)29
 Network Content46

O

On-screen display112
 OPEN/CLOSE button12
 Open/Close button7
 Operating a Client Remotely87
 Operation Modes14
 OPTICAL IN jack (stereo)10
 OPTICAL OUT jack (stereo)10

P

Page Displayed at Power ON94
 PAGE scroll buttons11
 PCM format111
 PHONES jack8
 Play button7
 PLAY INFO. button11
 Play Information50
 Playback50
 Playback control buttons12
 Playlist111
 POWER AMP/TV button11
 Preparation on Each Client33
 Presets54
 PS/2 Keyboard75, 95
 PS/2 KEYBOARD port8

R

Radio46
 RADIO button8, 12
 Radio Data System55
 Random50
 RANDOM button12
 Recall Play51
 Recording66
 RECORDING indicator8
 Registering an Internet Radio Station84
 Remote control112
 REMOTE terminal10
 Renaming Items from the Radio Presets List85
 Repeat50
 REPEAT button12
 RS-232C port9

S

Save to Preset55
 Screen Saver94
 Search all channels57
 Search category57
 Server112
 Server Address91
 Server ID40
 Server IP Address100
 Setting the Timer Playback89
 Song111
 STANDBY7
 STANDBY/ON button7, 12

Stop button7
 Store66
 Store from CD66
 Store from Inputs66
 Store from Radio66
 Storing111
 Subnet41
 Subnet Mask37, 41
 Subnet mask35, 112
 S-VIDEO port10
 System Utilities menu101

T

TCP/IP112
 Time view50
 Time Zone91
 TIMER button12
 TIMER indicator8
 TOP MENU button11
 TV/AMP switch11

U

Universal Remote Control17
 Updating Client Firmware45
 Updating the MCX-2000 Firmware103

V

Version102
 VIDEO port10
 VOL. buttons11

W

W_LAN ANT9
 Web Browser76
 WEP112
 WEP Key38, 42
 Wired LAN112
 Wireless LAN38, 100, 112

X

XM (US model only)54
 XM jack (US model only)9
 XM Radio58
 XM Satellite Radio55

Y

Yamaha AV Receiver98

