

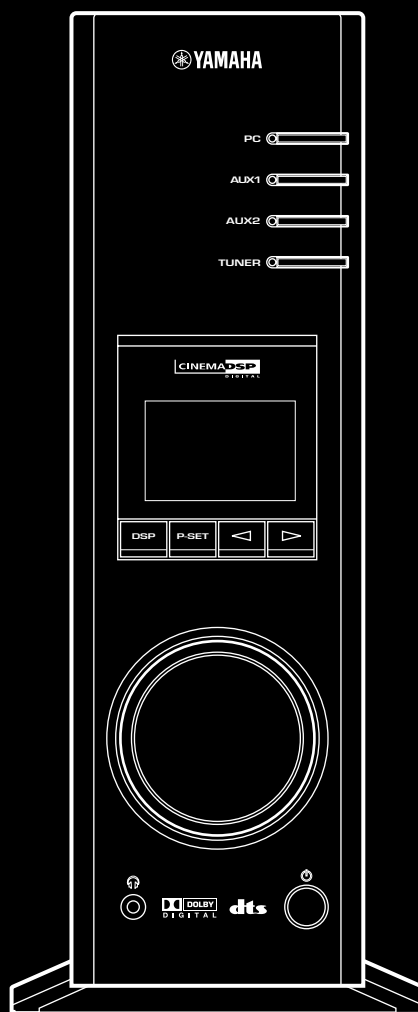

PERSONAL RECEIVER

RP-U200



SET UP MANUAL

MANUEL DE CONFIGURATION

SET UP-HANDBUCH

INSTALLATIONSANVISNING

MANUALE DI IMPOSTAZIONE

MANUAL DE CONFIGURACIÓN

INSTALLATIEHANDLEIDING

The owner's manual for this model consists of two volumes, **“SET UP MANUAL”** and **“OPERATION MANUAL”**.

Le manuel d'utilisation pour ce modèle se compose de deux volumes, le **“MANUEL DE CONFIGURATION”** et le **“MANUEL D'UTILISATION”**.

Die Anleitung für dieses Modell besteht aus zwei Teilen: aus dem **“SET UP-HANDBUCH”** und der **“BEDIENUNGSANLEITUNG”**.

Bruksanvisning för denna apparat består av två delar: **“INSTALLATIONSANVISNING”** och **“BRUKSANVISNING”**

Il manuale di questo modello è composto da due libretti, **“MANUALE DI IMPOSTAZIONE”** e **“MANUALE DELLE ISTRUZIONI”**

El manual de propietario para este modelo consta de dos volúmenes, **“MANUAL DE CONFIGURACIÓN”** y **“MANUAL DE OPERACIONES”**

De gebruiksaanwijzing voor dit model bestaat uit twee handleidingen, de **“INSTALLATIEHANDLEIDING”** en de **“BEDIENINGSHANDLEIDING”**

- * This manual uses terms utilized by the English operating system as shown on the computer monitor. If the operating system you are using is in another language, please replace the English terms with the terms used in your computer's operating system.
- * Ce manuel utilise des termes employés par les systèmes d'exploitation en langue anglaise tels qu'ils apparaissent sur le moniteur d'un ordinateur. Si votre système d'exploitation utilise une autre langue, veuillez remplacer la terminologie anglaise par celle qu'il utilise.
- * In dieser Anleitung werden Ausdrücke verwendet, die – wie auf dem Computermonitor angezeigt – vom englischen Betriebssystem genutzt werden. Wenn Sie ein anderssprachiges Betriebssystem verwenden, ersetzen Sie bitte die englischen Ausdrücke durch die von Ihrem Betriebssystem verwendeten Ausdrücke.
- * I bruksanvisningen används termerna från det engelska operativsystemet för datorn. Om ditt operativsystem använder ett annat språk, måste du ersätta de engelska termerna med de termer som gäller på språket som används.
- * Questo manuale utilizza dei termini utilizzati dal sistema operativo inglese, come è indicato sul monitor del computer. Se il sistema operativo del vostro computer è in un'altra lingua, sostituite i termini in inglese da quelli usati nel sistema operativo del vostro computer.
- * Este manual utiliza términos utilizados por el sistema operativo en inglés, tal como se muestran en el monitor. Si el sistema operativo que está utilizando está en otro idioma, sustituya por favor los términos en inglés por los términos utilizados en el sistema operativo de su ordenador.
- * In deze handleidingen worden de termen van het Engelstalige besturingssysteem gebruikt zoals ze op het computerscherm verschijnen. Als u een besturingssysteem in een andere taal gebruikt, gelieve dan de Engelse termen te vervangen door de termen die in het besturingssysteem van uw computer worden gebruikt.

GETTING STARTED

| | |
|--------------------------------------|---|
| Unpacking | 2 |
| Battery installation | 2 |
| Battery replacement | 2 |
| Remote control operation range | 2 |

GETTING STARTED

CONNECTIONS

| | |
|-------------------------------------|---|
| Terminals and their functions | 3 |
| Connecting your computer | 4 |
| Connecting audio equipment | 5 |
| Connecting speakers | 6 |
| Connecting an FM antenna | 9 |
| Plugging in this unit | 9 |

CONNECTIONS

INSTALLING USB DRIVER AND APPLICATION SOFTWARE

| | |
|--|----|
| Preparations before installation | 10 |
| System requirements | 10 |
| Installing the software | 11 |
| Microsoft Windows 98/98SE or Windows Me | 11 |
| Microsoft Windows 2000 Professional | 14 |
| Macintosh computer | 17 |

INSTALLING USB DRIVER AND
APPLICATION SOFTWARE

English

GETTING STARTED

Unpacking

After unpacking, check that the following items are supplied.

- Remote control
- Batteries (AA, R6, UM-3 type)

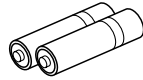
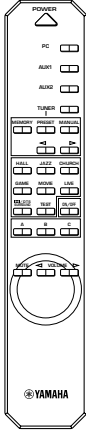

- USB cable

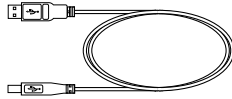

- Indoor FM antenna

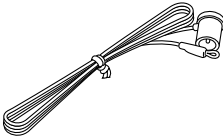

(U.S.A. and Canada models)

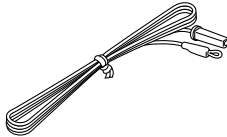

(U.K., Europe and Australia models)

- CD-ROM
The CD-ROM contains the Application Software and online help for controlling this unit from your computer.

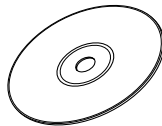

Battery installation

Since the remote control will be used for many of this unit's control operations, you should begin by installing the supplied batteries.

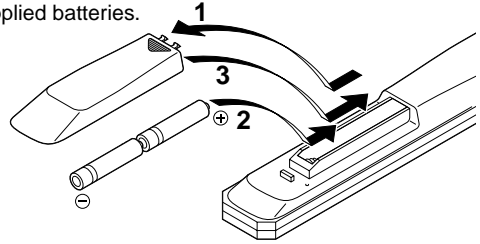

- 1 Turn the remote control over and remove the battery compartment cover by sliding it in the direction of the arrow.
- 2 Insert the batteries (AA, R6, UM-3 type) according to the polarity markings on the inside of the battery compartment.
- 3 Close the battery compartment cover.

Battery replacement

If you notice that the remote control must be used closer to the main unit, the batteries are weak. Replace both batteries with new ones.

Notes

- Use AA, R6, UM-3 batteries.
- Be sure the polarities are correct. (See the illustration inside the battery compartment.)
- Remove the batteries if the remote control is not to be used for an extended period of time.
- If the batteries leak, dispose of them immediately. Avoid touching the leaked material and avoid contact with clothing, etc. Clean the battery compartment thoroughly before installing new batteries.

Remote control operation range

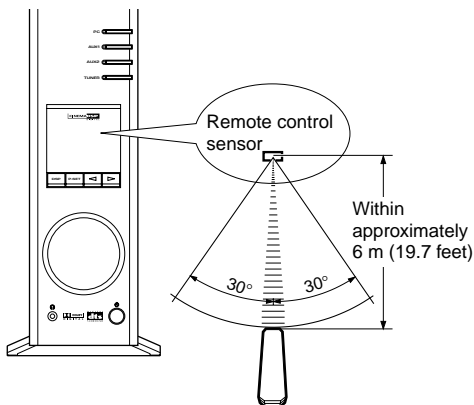

Notes

- The area between the remote control and the main unit must be clear of large obstacles.
- Do not expose the remote control sensor to strong lighting, in particular, an inverter type fluorescent lamp; otherwise, the remote control may not work properly. If necessary, position the main unit away from direct lighting.

CONNECTIONS

Never plug in this unit and other equipment until all connections are completed.



1. Make connections between this unit and other components by following the procedure below.
2. After all connections are finished, check that the connection cables are correctly connected.
3. After all connections are completed, plug in this unit and other equipment.

Note

Also, refer to the owner's manual for other equipment in the system.

Use commercially available connection cables (except the supplied USB cable).

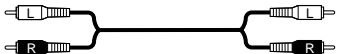
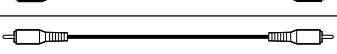
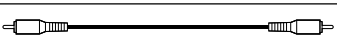
The color of this unit's inputs/outputs and pin-plug connection cables to be used for connecting to them are as follows:

| | | |
|-------|---|--|
| White | Analog audio signals for the left channel (stereo) |  |
| Red | Analog audio signals for the right channel (stereo) |  |
| Black | Analog audio signals (monaural) |  |
| | Digital audio signals (coaxial) |  |

Terminals and their functions

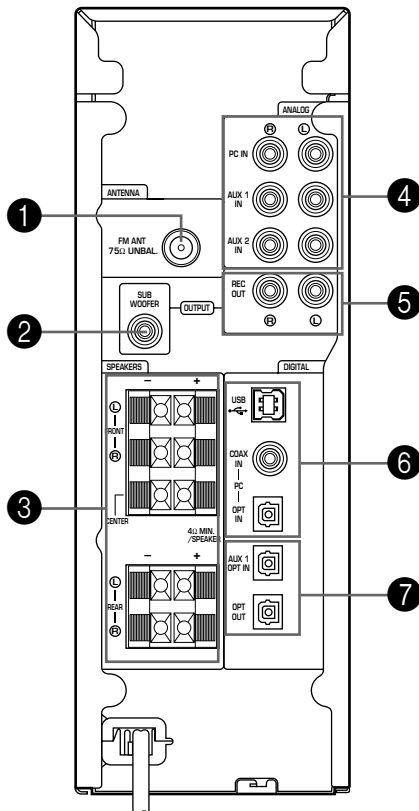

(U.S.A. model)

1 FM antenna connector

This connector is used to connect an FM antenna.

2 SUBWOOFER OUTPUT

This connector can be connected to an optional subwoofer, such as the Yamaha YST-SW45, for enhanced bass performance.

3 SPEAKERS outputs

Up to five speakers, such as the Yamaha NS-U40P speaker system can be connected to the FRONT L, R, CENTER, REAR L and R terminals. Use speakers whose impedance is 4Ω or more.

4 ANALOG inputs

These connectors are used to connect to the analog outputs of a PC sound card, CD player, MD recorder, tape deck, etc.

5 REC OUT

These connectors are used to connect to the analog inputs of an MD recorder or tape deck.

6 PC inputs & output (DIGITAL)

USB: If your computer has a USB port, connect it to this unit, using the supplied USB cable, for remote control of this unit from your computer.

PC COAX IN/OPT IN: These coaxial and optical connectors are used to connect to the digital outputs of a PC sound card, DVD-Video decoder board, etc.

7 Optical input & output (DIGITAL)

AUX 1 OPT IN: This connector is used to connect to an optical output of a CD player, MD recorder, etc.

OPT OUT: This connector is used to connect to an optical input of an MD recorder, a DAT deck, etc.

Connecting your computer

Audio from your computer can be fed to this unit using any of the following connectors: USB, DIGITAL PC COAX IN, DIGITAL PC OPT IN, or ANALOG PC IN. If you use all of these connectors for connection, you can select the connector(s) to use on this unit's front panel or the remote control.

Connecting to the USB port (1)

If your computer has a USB port, connect it to this unit's USB terminal using the supplied USB cable, as shown below.

A single USB connection is all that's required to listen to audio from your computer on this unit, feed audio from an external source connected to this unit to your computer, and control this unit remotely from your computer, using the supplied Application Software.

If your computer doesn't have a USB port, you can still connect it to this unit using the analog or digital input, but in this case you cannot use this unit's Application Software.

Note

Connect the USB cable when installing the USB driver software on your computer. Refer to the section "INSTALLING USB DRIVER AND APPLICATION SOFTWARE".

Connecting to analog inputs (2)

Connect the analog audio outputs on your computer or a PC sound card to this unit's ANALOG PC IN. Use a commercially available pin-plug cable for connection, and be careful not to mix up the left and right connections.

Connecting to digital inputs (3)

To play DVD-Video discs encoded with Dolby Digital or DTS, your computer must have a DVD-ROM drive and DVD-Video decoder board, which should be connected to this unit via the DIGITAL PC COAX IN or DIGITAL PC OPT IN.

Use a commercially available pin-plug cable for connecting to the DIGITAL PC COAX IN, and use a commercially available optical fiber cable for connecting to the DIGITAL PC OPT IN.

Note

The DIGITAL PC OPT IN has priority over the DIGITAL PC COAX IN, so if you connect to both inputs, the signal received at the DIGITAL PC OPT IN is used.

Protective Caps

When connecting to an optical connector, remove its protective cap first. When an optical connector is not being used, replace its cap to prevent dust entering the connector.

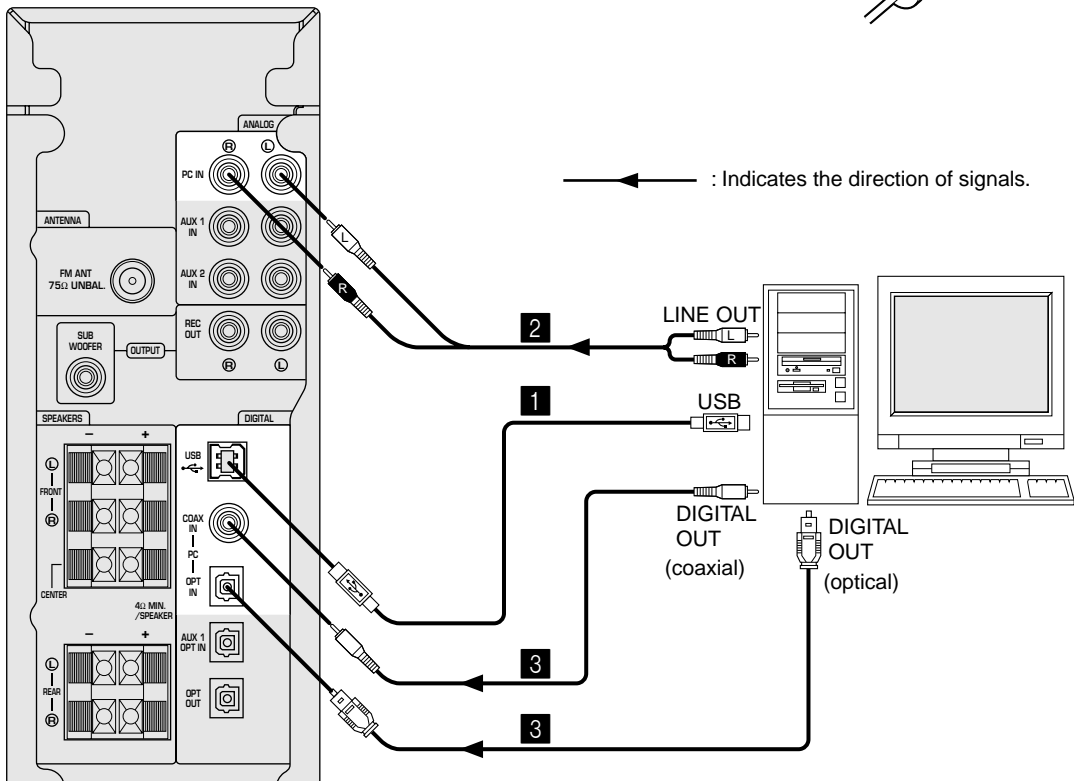
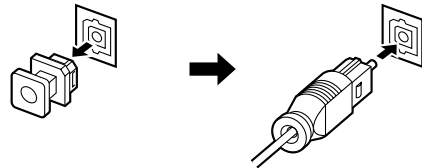

← : Indicates the direction of signals.

Connecting audio equipment

The following illustrations show how to connect a CD player, MD recorder, etc. using both analog and digital connections. However, it's not necessary to make both connections.

Audio connections

- Be careful not to mix up the left and right connections.
- If you wish to record analog sound signals inputted to this unit, connect the analog inputs of a tape deck or MD recorder to this unit's REC OUT.

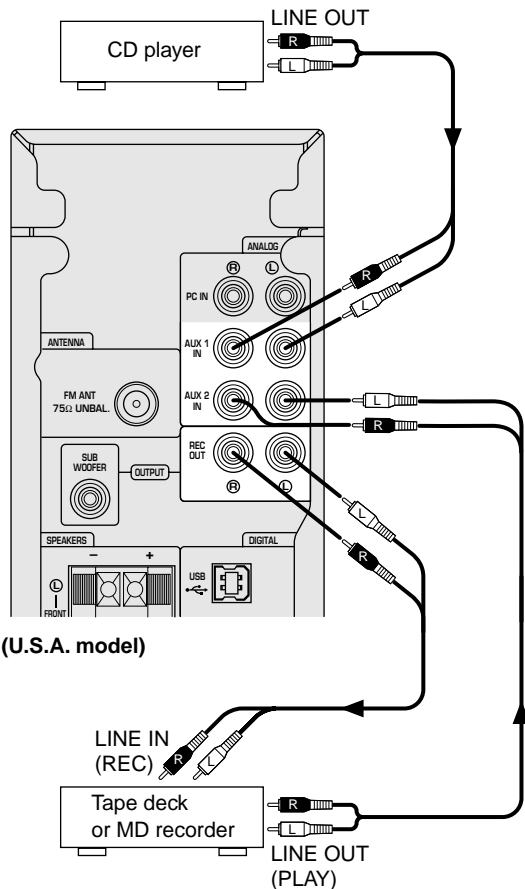

Digital connections

If you wish to record digital sound signals inputted to this unit, connect the optical digital input of an MD recorder or a DAT deck to this unit's DIGITAL OPT OUT.

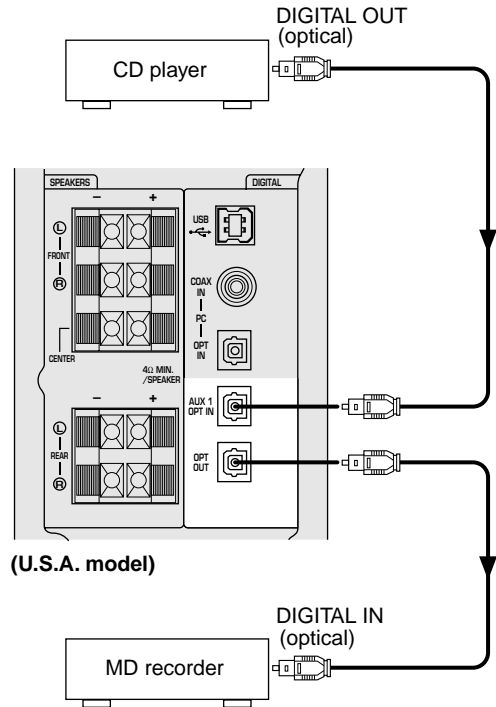

Notes

Notes

Connecting a turntable

- A turntable cannot be connected to this unit directly. Use a commercially available phono preamp to connect a turntable to this unit, or connect a turntable incorporated with a phono equalizer amplifier.
- The REC OUT and DIGITAL OPT OUT can be used at the same time since they output signals independently.

- When playing an ordinary CD on this unit following playback of a CD or an LD encoded with DTS, some operations, such as resetting the input selector keys, may be required.
- If some data processing (e.g. volume level changes) is applied to DTS-encoded signals on the CD, DVD or LD player, this unit will not recognize the signals as DTS-encoded signals. Because of this, this unit cannot reproduce a DTS-encoded source played on such a player even if it is connected to this unit with a digital connection.
- When an error occurs in the player's digital output data during playback of an LD or CD encoded with DTS, playback may be disrupted. If this occurs, stop playback and repower the player.
- When digital sound signals from the computer are played, errors in WAV signals, etc. may occur resulting in noise or a playback failure.

Connecting speakers

To reproduce multi-channel surround sounds with this unit, connect five speakers (Yamaha NS-U40P, etc.) to this unit as follows: a pair of front speakers to the FRONT L and R terminals, a center speaker to the CENTER terminal, and a pair of surround speakers to the REAR L and R terminals. When using only one pair of speakers, connect one speaker to the FRONT L terminal, and the other to the FRONT R terminal.

* When the supplied Application Software is installed on the computer connected to this unit, the Application enables you to make "Speaker Settings". In the settings, you can select the speakers to use and not to use, and also set the sizes of the speakers to use. Refer to page 27 of the separate "OPERATION MANUAL" for details.

Notes

- Use speakers which do not have a built-in amplifier.
- Use speakers whose impedance is 4Ω or more.
- Connect the left speaker to the left speaker connector on this unit and the right speaker to the right speaker connector.
- Make sure that the + and – polarity markings of the speaker cables are observed and set correctly. If these cables are reversed, the sound will be unnatural and lack bass.

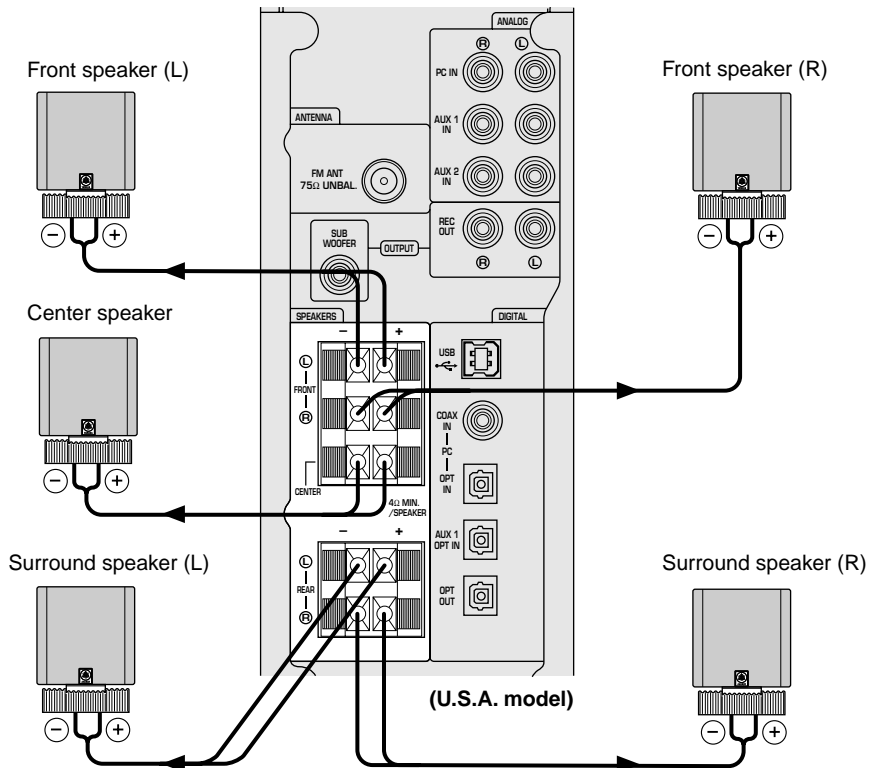

Speaker Cables

Strip 10 mm of insulation off the end of each speaker cable, and then twist the bare wires to prevent loose strands, which can cause short circuits.

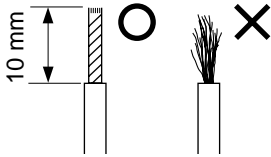

How to connect:

- ① Press and hold the speaker connector levers.
 - ② Insert the bare ends of the speaker cables into the terminal holes.
 - ③ Then release the levers.
- * Try pulling gently on each cable to make sure that it is secure.

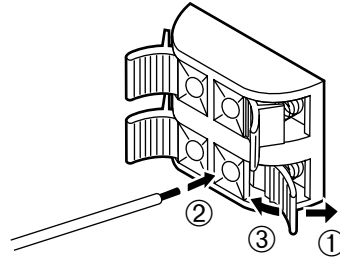

Adding a subwoofer

It is recommended to connect a subwoofer to this unit to enhance the bass performance of your system and reproduce surround sounds of Dolby Digital, DTS and CINEMA DSP effectively.

Notes

- The SUBWOOFER OUTPUT is a line-level output. Use a subwoofer which has its own built-in power amplifier, such as the Yamaha YST-SW45.
- If no sound is reproduced from the subwoofer, check the “Speaker Settings” in the Application Software. Refer to page 27 of the separate “OPERATION MANUAL” for details.

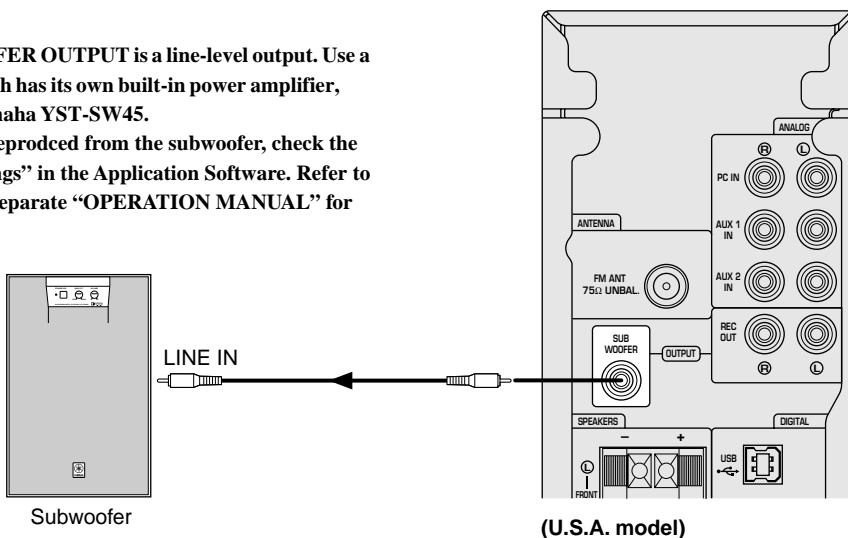

(U.S.A. model)

Setting up the speakers

The role of the respective speakers

In a 5.1-channel surround system, the front speakers are used for reproducing main channel sound (normal stereo sound) and effect sound. The surround speakers are used for surround and effect sounds, and the center speaker is for center channel sound (dialog, etc.). (The center speaker can be omitted if you prefer, however, the best result is obtained with a full five speaker system.)

The subwoofer is used for reproducing low frequency sounds from the front, center and surround channels. The subwoofer also reproduces sounds of the subwoofer channel when a DTS or Dolby Digital encoded source is played.

Recommended speaker placement

Before making connections, place all speakers in their respective positions. The positioning of the speakers is important because it controls the overall sound quality of this system.

Place the speakers depending on your listening position by following the instructions below.

Front speakers:

On both sides of and at approximately the same height as your computer monitor.

The distances from each speaker to the listening position must be the same.

Surround speakers:

Behind your listening position or on both sides of the listening room. According as the condition of your listening room, place the surround speakers on the floor or the shelf, or mount them on the wall.

Center speaker:

Precisely between the front speakers.

* The center speaker can be mounted on the monitor if it is a magnetically shielded type.

Subwoofer:

On the floor. Place the subwoofer on the position where you can get the optimum bass performance from the listening position.

Note

Use magnetically-shielded speakers and subwoofer. If the monitor picture is disturbed even by using the magnetically-shielded speakers, set the speakers apart from the monitor.

A set up example

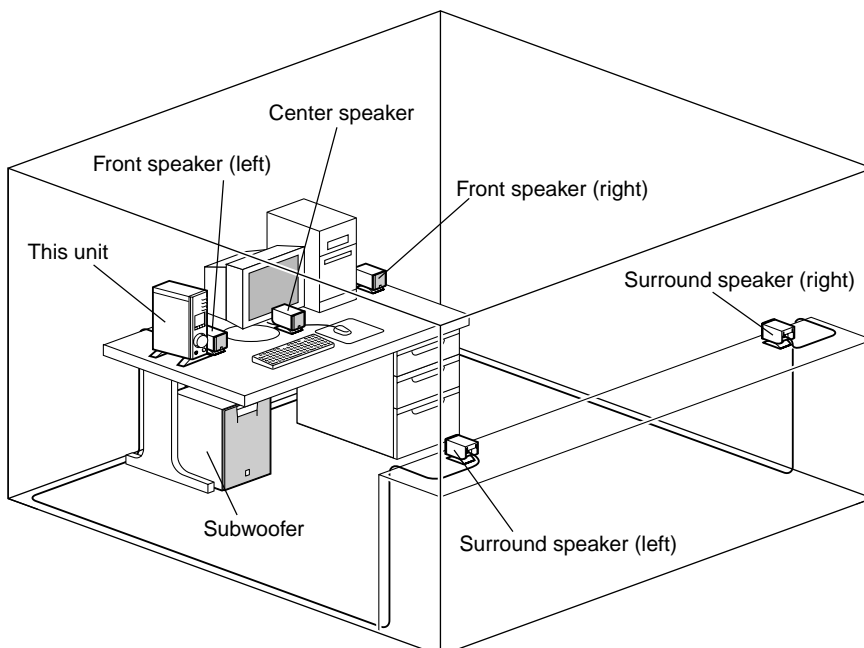

Connecting an FM antenna

Connect an FM antenna to the FM ANT terminal of this unit by following the figure and procedures below.

Indoor FM antenna (supplied)



(U.S.A. model)

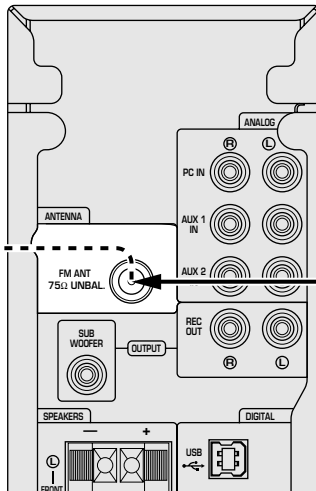

Outdoor FM antenna

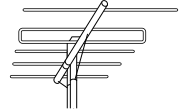

F-type plug adaptor

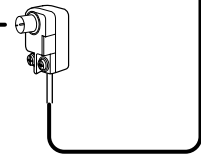

75Ω coaxial cable

It is recommended to use an outdoor FM antenna for good reception.

Depending on the area, good reception may not be obtained because it is far from FM radio stations or obstructed by tall buildings, mountains, and so on. Select a type of antenna suitable for your area.

Also, to minimize the effects of automobile ignition noise, locate the antenna as far away from heavy traffic as possible.

- Use the supplied indoor FM antenna only in areas with exceptionally good reception.

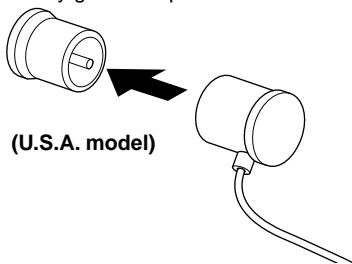

(U.S.A. model)

Insert the antenna connector securely.

- * Set the indoor FM antenna as far away from the computer and the monitor as possible, and set it to a position where the best reception is obtained.

- For connecting an outdoor FM antenna
Use a 75Ω coaxial cable for connecting the antenna. If the antenna is located far from this unit, the use of 5C2V cable is recommended to handle the weak radio signal.

- * If you connect an outdoor FM antenna to this unit, do not connect the indoor FM antenna to this unit.

Plugging in this unit

After completing all connections, plug the AC power cord into a household AC outlet.

Note

Unplug the AC power cord from the AC outlet if this unit is not to be used for a long period of time.

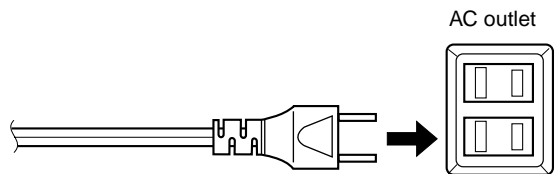

(U.S.A. model)

INSTALLING USB DRIVER AND APPLICATION SOFTWARE

When connecting this unit and your computer with the USB cable and controlling this unit from the computer, you must install the following software on your computer.

- ◆ **USB driver software:** Necessary for this unit to communicate with your computer Use the software originally supplied with the OS (Operating System) running on your computer
- ◆ **Application Software:** Used to control this unit from a computer Download from the supplied CD-ROM
- ◆ **Online help :** Instructions for using the Application Access from the supplied CD-ROM

This section explains how to install the software. The installation method differs from the OS running on your computer. Refer to the instructions suitable for your OS below.

Preparations before installation

- **Make sure that the USB cable is not connected to this unit and that your computer is not activated.**
- Make sure that your computer meets the **system requirements** listed below.
If your computer does not meet the system requirements, you can use the computer as an input source by connecting it to the analog or digital input(s) of this unit. In that case, however, the supplied Application Software cannot be used.
- You may be requested to insert your OS's CD-ROM during the installation, so please have it ready before commencing.
- The installing method may differ from the instructions below depending on the operating environment of your computer. In such a case, follow the instructions shown on the monitor. If you still have any question, inquire at the manufacturer of your computer or a computer dealer.

System requirements

Your computer must meet the following system requirements to use the supplied Application Software.

Microsoft Windows 98/98SE, Windows Me or Windows 2000 Professional

Operating System

Microsoft Windows 98/98SE, Windows Me or Windows 2000 Professional

Computer

A computer with a USB port as a standard equipment and preinstalled with the above OS.

Windows is a registered trademark of Microsoft Corporation in the United States and/or other countries.

Macintosh

Operating System

Mac OS 9.04, 9.1 or greater (except for the OS 9.04 preinstalled on Macintosh computers put on the market in June of 2000 or before)

Computer

Macintosh computer preinstalled with the above OS and equipped with a USB port as a standard equipment

Macintosh is a trademark of Apple Computer, Inc., registered in the U.S. and other countries.

Installing the software

Microsoft Windows 98/98SE or Windows Me

■ Installing and checking the USB driver

1 Turn on your computer and, if it's not running already, start Windows 98/98SE or Windows Me.

2 Plug the AC power cord of this unit into the AC outlet.

This unit can be on or in standby mode when installing the driver.

3 Connect this unit to a USB port on the computer using the supplied USB cable.

Windows automatically detects this unit and installs the necessary driver software. Make operations as indicated in the dialog box. You may be requested to insert your Windows OS CD-ROM.

* The installation may take a longer time depending on the system environment. After the installation dialog box disappears, wait several minutes.

Check that the USB driver has been installed successfully by following the procedure below.

4 Click the Windows "Start" button and select "Settings", and then "Control Panel".

The Control Panel window appears.

5 Double-click the "System" icon.

The System Properties window appears.

6 Click the "Device Manager" tab.

The Device Manager window appears.

7 Click the "View devices by type" option button.

8 Click the "+" symbol next to "Sound, video and game controllers," and make sure that "USB Audio Device" appears in the list, as shown.

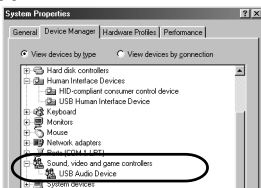

* The screen image is for Windows 98SE.

* When using Windows Me, "?" may be shown at the head of "USB Composite Device" in green. This means the USB driver has been installed with the Generic ID supplied with the operating system. (This is not an error message.)

9 Click the "+" symbol next to "Human Interface Devices", and make sure that "HID-compliant consumer control device" and "USB Human Interface Device" appear in the list, as shown.

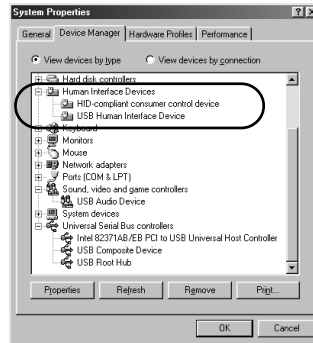

* The screen image is for Windows 98SE.

10 Click the "+" symbol next to "Universal Serial Bus controllers" and make sure that "USB Composite Device" appears in the list, as shown.

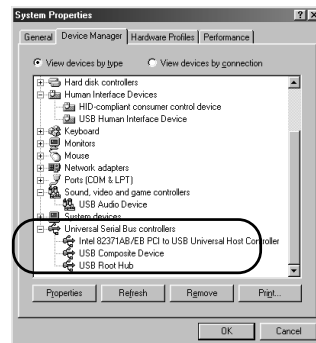

* The screen image is for Windows 98SE.

Notes

- The device list on your computer may differ to that shown here.
- If "!" or "?" is shown at the head of the device name, check the followings:
 - * The USB cable is firmly connected.
 - * The AC power cord of this unit is plugged into an AC outlet.
- If the driver has not been successfully installed, disconnect the USB cable and connect it again. Then try to install the driver again. If installation still fails, restart Windows and try again.

Make the following settings on your computer after the installation of the driver is finished.

**Setting of Audio and Audio CD
[Windows 98/98SE only]**

- * Terminate all the activated applications.
- * When using Windows 98SE, restart Windows, first.

1 Click the Windows “Start” button and select “Settings”, and then “Control Panel”.

2 Double-click the “Multimedia” icon.

3 Click the “Audio” tab and select “USB Audio Device” at “Preferred device” of “Playback”.

- * Usually, this setting is automatically made.
- * If “USB Audio Device” does not appear, restart Windows.

4 Click the “CD Music” tab and select the CD-ROM drive for playing audio CDs.

5 Click the check box of “Enable digital CD audio for this CD-ROM device” to enter the check mark.

- * It may happen that the check box cannot be clicked because some CD-ROM drives cannot be used for playing audio CDs.

6 Click “OK” and close the “Multimedia” setting panel.

7 Restart Windows.

Note

When using two or more drives, you must make the above setting for each drive.

**Checking the Audio setting
[Windows Me only]**

1 Click the Windows Me “Start” button and select “Settings”, and then “Control Panel”.

2 Double-click the “Sounds and Multimedia” icon.

3 Click the “Audio” tab and select “USB Audio Device” at “Preferred device” of “Sound Playback”.

- * Usually, this setting is automatically made.
- * If “USB Audio Device” does not appear, restart Windows.

**Checking sound output and adjusting volume
[Windows 98/98SE and Windows Me]**

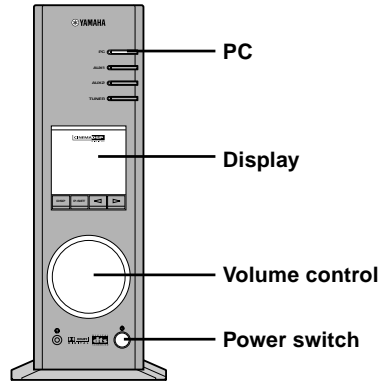

1 Make the following operations on the front panel of this unit.

- a) Press the power switch to turn on this unit. (Some messages are shown on the display.)
- b) Press the PC input selector key repeatedly to select USB as the input source.
- c) Use the volume control to adjust the volume. (Set the control to about “30”.)

2 Adjust the volume on the computer as follows.

- a) Double-click the speaker icon on the task tray, or select “Start”, “Programs”, “Accessories”, “Entertainment” in this order and click “Volume Control”. (The volume adjustment window appears.)
- b) Adjust the volume by dragging the “Volume” slider. Set the slider between the center and max. positions.

- * Do not enter the check mark in the “Mute” check box. If entered, sound output will stop.

3 Click the Windows “Start” button and select “Settings”, and then “Control Panel”.

4 Double-click the “Sounds” (or “Sounds and Multimedia”) icon.

5 Click the “Sounds” tab.

6 Check that the sound is output normally by outputting “Default sound”, etc. from “Events” (or “Sound Events”).

- * If no sound is heard, restart Windows and check again.

Next, install the Application Software and Online Help from the supplied CD-ROM.

■ Installing the Application Software

* Terminate all the activated applications (including virus checkers) on the computer first.

1 Insert the CD-ROM into the CD-ROM or DVD-ROM drive.

If the Windows Autorun feature is turned on, the installation start-up screen appears automatically.

2 Continue with the installation as prompted.

If the Windows Autorun feature is not turned on

Display the contents of the CD-ROM by using "My Computer" etc., and double-click on "Readme.txt". The installation method is described in this file.

■ Using the Application Software and Online Help

This section explains how to start the Application Software and view the online help.

1 Click the Windows "Start" button and select "Programs", "YAMAHA RP-U200", "RP-U200" in this order.

The Application Software starts.

2 To view the online help, click the Windows "Start" button and select "Programs", "YAMAHA RP-U200", "Help" in this order.

The online help, which explains how to use the Application Software, starts.

Note

Never disconnect the USB cable while starting up the Application Software. If disconnected, the computer may freeze.

■ Uninstalling the Application Software

This section explains how to uninstall the Application Software.

1 Terminate the Application Software and online help.

2 Click the Windows "Start" button and select "Settings", and then "Control Panel".

The Control Panel window appears.

3 Double-click the "Add/Remove Programs" icon.

The "Add/Remove Programs Properties" window appears.

4 Select "YAMAHA RP-U200 Application" in the software list.

"YAMAHA RP-U200 Application" is highlighted.

5 Click the "Add/Remove Programs" button and continue as prompted.

Microsoft Windows 2000 Professional

■ Installing and checking the USB driver

1 Turn on your computer and, if it's not running already, start Windows 2000 Professional, and log in with Administrator.

2 Plug the AC power cord of this unit into the AC outlet.

This unit can be on or in the standby mode when installing the driver.

3 Connect this unit to a USB port on the computer using the supplied USB cable.

Windows automatically detects this unit and installs the necessary driver software.

* The installation may take a longer time depending on the system environment. After the dialog box for installation disappears, wait several minutes.

Check that the USB driver has been installed successfully by following the procedure below.

4 Click the Windows "Start" button and select "Settings", and then "Control Panel".

The Control Panel window appears.

5 Double-click the "System" icon.

The System Properties window appears.

6 Select the "Hardware" tab, and click the "Device Manager".

The Device Manager window appears.

7 Select the "View" tab, and click the "Devices by type" option button.

8 Click the "+" symbol next to "Sound, video and game controllers," and make sure that "USB Audio Device" appears in the list, as shown.

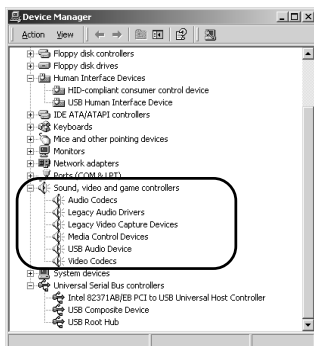

9 Click the "+" symbol next to "Human Interface Devices", and make sure that "HID-compliant consumer control device" and "USB Human Interface Device" appear in the list, as shown.

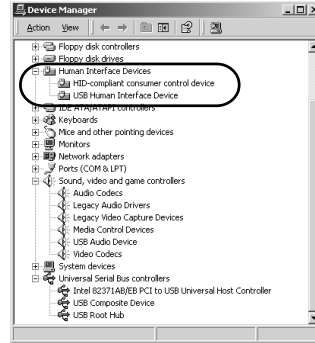

10 Click the "+" symbol next to "Universal Serial Bus controllers" and make sure that "USB Composite Device" appears in the list, as shown.

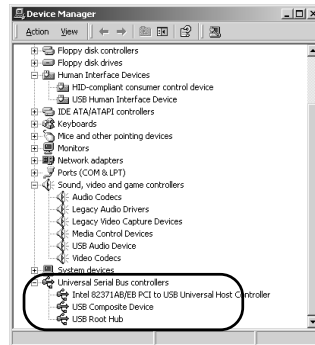

Notes

- The device list on your computer may differ to that shown here.
- If "!" or "?" is shown at the head of the device name, check the followings:
 - * The USB cable is firmly connected.
 - * The AC power cord of this unit is plugged into an AC outlet.
- If the driver has not been successfully installed, disconnect the USB cable and connect it again. Then try to install the driver again. If installation still fails, restart Windows and try again.

Make the following settings on your computer after the installation of the driver is finished.

Setting of Audio and Audio CD

- 1** Click the Windows “Start” button and select “Settings”, and then “Control Panel”.
- 2** Double-click the “Sounds and Multimedia” icon.
- 3** Click the “Audio” tab and select “USB Audio Device” at “Preferred device” of “Sound Playback”.
* Usually, this setting is automatically made.
- 4** Click the “Hardware” tab and double-click the item of the DVD or CD-ROM to be used in the “Devices”.
- 5** Click the “Properties” tab, and click the check box of “Enable digital CD audio for this CD-ROM device” to enter the check mark.
* It may happen that the check box cannot be clicked because some CD-ROM drives cannot be used for playing audio CDs.
- 6** Restart Windows, and log in with Administrator.

Note

When using two or more drives, you must make the above setting for each drive.

Checking sound output and adjusting volume

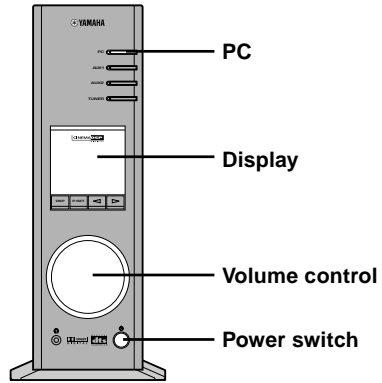

- 1** Make the following operations on the front panel of this unit.
 - a) Press the power switch to turn on this unit. (Some messages are shown on the display.)
 - b) Press the PC input selector key repeatedly to select USB as the input source.
 - c) Use the volume control to adjust the volume. (Set the control to about “30”.)
- 2** Adjust the volume on the computer as follows.
 - a) Double-click the speaker icon on the task tray, or select “Start”, “Programs”, “Accessories”, “Entertainment” in this order and click “Volume Control”. (The volume adjustment window appears.)
 - b) Adjust the volume by dragging the “Volume” slider. Set the slider between the center and max. position.
* Do not enter the check mark in the “Mute” check box. If entered, sound output will stop.
- 3** Click the Windows “Start” button and select “Settings”, and then “Control Panel”.
- 4** Double-click the “Sounds and Multimedia” icon.
- 5** Click the “Sounds” tab.
- 6** Check that the sound is output normally by outputting “Default Beep”, etc. from “Sound Events”.

* If no sound is heard, restart Windows and check again.

Next, install the Application Software and Online Help from the supplied CD-ROM.

■ Installing the Application Software

1 Insert the CD-ROM into the CD-ROM or DVD-ROM drive.

If the Windows Autorun feature is turned on, the installation start-up screen appears automatically.

2 Continue with the installation as prompted.

If the Windows Autorun feature is not turned on

Display the contents of the CD-ROM by using "My Computer" etc., and double-click on "Readme.txt". The installation method is described in this file.

■ Using the Application Software and Online Help

This section explains how to start the Application Software and view the online help.

1 Click the Windows "Start" button and select "Programs", "YAMAHA RP-U200", "RP-U200" in this order.

The Application Software starts.

2 To view the online help, click the Windows "Start" button and select "Programs", "YAMAHA RP-U200", "Help" in this order.

The online help, which explains how to use the Application Software, starts.

Note

Never disconnect the USB cable while starting up the Application Software. If disconnected, the computer may freeze.

■ Uninstalling the Application Software

This section explains how to uninstall the Application Software.

1 Terminate the Application Software and online help.

2 Click the Windows "Start" button and select "Settings", and then "Control Panel".

The Control Panel window appears.

3 Double-click the "Add/Remove Programs" icon.

The "Add/Remove Programs" window appears.

4 Select "YAMAHA RP-U200 Application" in the software list.

"YAMAHA RP-U200 Application" is highlighted.

5 Click the "Change/Remove" button and continue as prompted.

Macintosh computer

■ Connections and setup

1 Plug the AC power cord of this unit into the AC outlet.

2 Start the Macintosh.

3 Connect this unit to a USB port on the computer using the supplied USB cable.

The driver software for USB audio is automatically installed.

4 Press the power switch of this unit to turn on this unit.

Some messages are shown on the display.

Notes

- The sound output destination cannot be changed from “Choose a device for sound output” on the “Control Panels”. When using the internal speaker of the Macintosh as the sound output destination, disconnect the USB cable connecting this unit and the Macintosh.
- When using headphones with this unit connected to the USB port on the Macintosh, use the headphone jack on this unit, not the jack on the Macintosh.
- Since the Macintosh issues a start-up sound at power-on before the sound signal via the USB connection is activated, the start-up sound cannot be issued via the USB connection. To play the start-up sound via this unit, you need a separate analog connection between this unit and the Macintosh. (When USB MIX is set to “ON” from the Setup Panel of the Application Software, you can mix the start-up sound via the analog connection with the same sound via the USB connection without making any change in the input selector settings.)

Checking sound output and adjusting volume

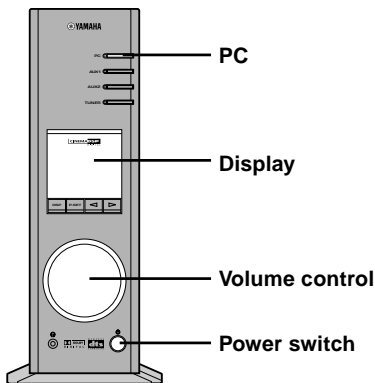

1 Make the following operations on the front panel of this unit.

- Press the PC input selector key repeatedly to select USB as the input source.
- Use the volume control to adjust the volume. (Set the control to about “30”.)

2 Check that the sound is output normally by outputting “Alert Sounds”, etc. from “Sound” on the “Control Panels” on the Macintosh.

3 Adjust the volume by dragging the “Sound” tab on the “Control Panels”. Set the tab between the center and max. position.

Next, install the Application Software and Online Help from the supplied CD-ROM.

■ Installing the Application Software

1 Insert the CD-ROM into the CD-ROM or DVD-ROM drive.

The CD-ROM includes the simple installer “RP-U200 Installer” and the installation data folder.

2 Open the folder “English”, and double-click the simple installer “RP · AP · DP Installer” to start it.

Select the model name of this unit and the destination of the installation.

The Application Software and Online Help are installed on the hard disk.

* Files installed by the simple installer

The simple installer “RP · AP · DP Installer” copies the “RP · AP · DP Application” folder in the installation data folder to a specified location. It additionally copies the “RP · AP · DP Help” folder into the “Help” folder in the “System Folder” on the startup disk.

- * To install the Application Software without using the simple installer, follow the instructions below.

Installing the Application Software without using the simple installer “RP · AP · DP Installer”:

1 Copy the “RP-U200 Application” folder in the installation data folder to any hard disk.

2 Copy the “RP-U200 Help” folder in the installation data folder to the “Help” folder in the “System Folder” on the startup disk.

You can refer to this Online Help file with Mac Help.

■ How to use the Application Software and Online Help

All operating instructions for the Application Software is available from the Online Help. To refer to the instructions, select the Online Help from the menu displayed upon activation of the Application Software.

Relationship between operation on this unit and the Application Software

When an operation button or the volume control on this unit is operated with the Application Software activated, the display screen of the Application Software automatically changes to reflect the changes made on the unit. When this unit is operated as above while the display shows the screens of the Application Software data and another program, the display of the other program (for example, the playback display of QuickTime) may be partially disturbed as the screen of the Application Software responds to the operation on this unit. To avoid this, operate this unit without activating the Application Software.

