

Reference Manual

Contents

Using the MODX Manuals.....	2	Reference	25
Basic Structure	3	Display (touch panel) configuration	25
Functional Blocks	3	Performance Play (Home).....	27
Tone Generator Block.....	4	Motion Control.....	33
Tone Generator block	4	Mixing.....	50
A/D Input Block	10	Scene.....	55
Sequencer Block.....	10	Play/Rec	60
Arpeggio Block.....	11	Normal Part (AWM2) Edit.....	66
Arpeggio categories	11	Element Common Edit (Common)	66
Sub categories.....	11	Element Edit (Element)	107
Arpeggio Type Name	12	Element All (All Element)	130
Arpeggio-related settings.....	13	Drum Part Edit	133
Arpeggio playback types.....	14	Key Common Edit (Common)	133
Creating an Arpeggio.....	16	Key Edit (Key)	140
Motion Sequencer Block	17	Normal Part (FM-X) Edit.....	145
Effect Block	19	Operator Common Edit (Common)	145
Effect structure.....	19	Operator Edit (Operator)	155
Effect connection	20	Common/Audio Edit (Common/Audio).....	159
About the Vocoder Effect.....	20	Category Search.....	176
Envelope Follower Block.....	21	Performance Category Search.....	176
Controller Block	22	Arpeggio Category Search (Arp Category Search).....	180
Keyboard	22	Waveform Category Search (Waveform Search).....	182
Pitch Bend wheel	22	Rhythm Pattern	184
Modulation wheel.....	22	Utility	187
Assignable Switches.....	22	Live Set.....	212
Knobs and Control Sliders	22	Live Set	212
Super Knob.....	22	Live Set Edit (Edit)	213
Internal Memory	23	Live Set Register (Register)	216
		Connecting an iPhone or iPad	217

Using the MODX Manuals

Your MODX6/MODX7/MODX8 synthesizer comes with four different reference guides—the Owner’s Manual, the Reference Manual (this document), the Synthesizer Parameter Manual, and the Data List. While the Owner’s Manual is packaged together with the synthesizer as a hardcopy booklet, this Reference Manual, the Synthesizer Parameter Manual, and the Data List are available for download from our web page as PDF documents.



Owner’s Manual (hardcopy booklet)

Describes how to set up your MODX6/MODX7/MODX8 and how to perform basic operations.

- This manual explains the following operations.
- Selecting Performances
- Playing the Keyboard
- Creating Your Own Live Sets
- Editing the Settings
- Recording and Playback
- Using as a Master Keyboard
- Connecting a Microphone or Audio Equipment
- Making Global System Settings
- Connecting External MIDI Instruments
- Using a Connected Computer
- Saving/Loading Data



Reference Manual (this PDF document)

Describes the internal design of your MODX6/MODX7/MODX8 and the various parameters that can be adjusted and set.



Synthesizer Parameter Manual (PDF document)

Explains the Part parameters, effect types, effect parameters, and MIDI messages that are used for synthesizers incorporating the Yamaha AWM2 and FM-X tone generators. Read the Owner’s Manual and Reference Manual first and then use this parameter manual, if necessary, to learn more about parameters and terms that relate to Yamaha synthesizers.



Data List (PDF document)

Provides lists such as the Waveform List, Performance List, Effect Type List, Arpeggio Type List, as well as reference materials such as the MIDI Implementation Chart.

Using the Reference Manual

- Using the display name tabs along the upper part of each page from the Reference section, you can jump to the page for parameter explanations of the corresponding display.
- You can click on any page number from the Table of Contents or within descriptive text to jump to the corresponding page.
- You can also click on desired items and topics you want to refer to in the “Bookmarks” index to the left of the main window, and jump to the corresponding page. (Click the “Bookmarks” tab to open the index if it is not displayed.)
- If you want to find information on a specific topic, function or feature, select “Find” or “Search” from the Adobe Reader “Edit” menu and enter a key word to locate the related information anywhere in the document.

NOTE The most-recent version of Adobe® Reader® can be downloaded from the following web page.
<http://www.adobe.com/products/reader/>

NOTE The names and positions of menu items may vary according to the version of Adobe Reader being used.

Information

- The illustrations and LCD screens as shown in this manual are for instructional purposes only, and may appear somewhat different from those on your instrument.
- All other trademarks are the property of their respective holders.
- iPhone, iPad, and Lightning are trademarks of Apple Inc., registered in the U.S. and other countries.

Select the display name tab Select the function

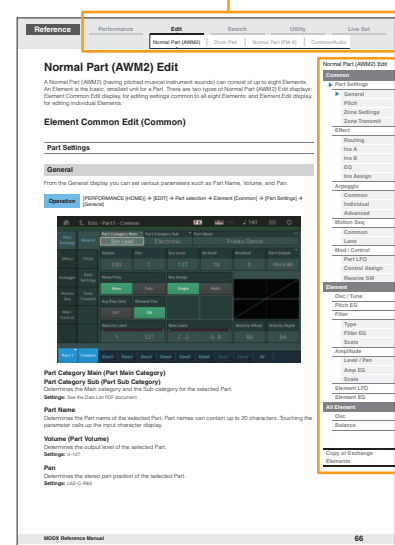

Basic Structure

Basic Structure

- ▶ Functional blocks
- ▶ Tone Generator block
- ▶ A/D Input block
- ▶ Sequencer block
- ▶ Arpeggio block
- ▶ Motion Sequencer block
- ▶ Effect block
- ▶ Envelope Follower block
- ▶ Controller block
- ▶ Internal Memory

Functional Blocks

The MODX6/MODX7/MODX8 system consists of eight main functional blocks: Tone Generator, A/D Input, Sequencer, Motion Sequencer, Arpeggio, Controller, Effect, and Envelope Follower.

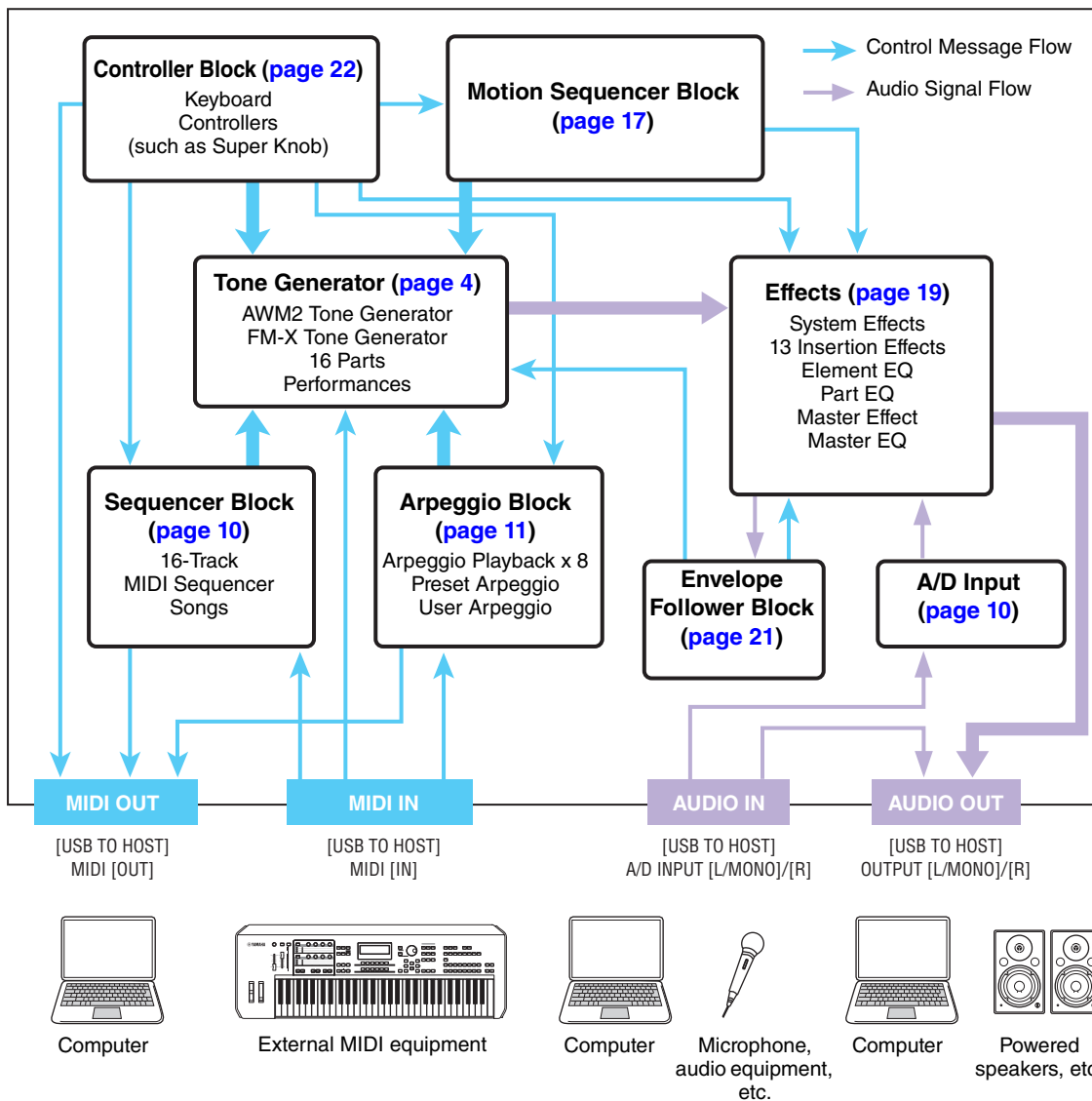

Reference

- ▶ Display (touch panel) config.
- ▶ Performance Play (Home)
- ▶ Motion Control
- ▶ Mixing
- ▶ Scene
- ▶ Play/Rec
- ▶ Normal Part (AWM) Edit
- ▶ Drum Part Edit
- ▶ Normal Part (FM-X) Edit
- ▶ Common/Audio Edit
- ▶ Category Search
- ▶ Utility
- ▶ Live Set
- ▶ iPhone/iPad connection

AWM2 (Advanced Wave Memory 2)

This instrument is equipped with an AWM2 tone generator block. AWM2 (Advanced Wave Memory 2) is a synthesis system based on sampled waves (sound material), and is used in many Yamaha synthesizers. For extra realism, each AWM2 Voice uses multiple samples of a real instrument's waveform. Furthermore, a wide variety of parameters—envelope generator, filter, modulation, and others—can be applied.

FM-X

This synthesizer also features an FM-X tone generator, in addition to the AWM2 block. The abbreviation “FM” of FM-X stands for “frequency modulation,” which is a special tone generation system that uses the frequency of one waveform to modulate another waveform, in order to produce a completely new one. In this synthesizer, there are eight FM Operators and a full 88 different Algorithm types. By changing the operator combination patterns, controlling the modulation with other parameters such as levels and envelopes, and using high-quality filters, effects, and EQ commonly with AWM2, you can create richly textured sounds that change in a highly complex fashion.

Tone Generator Block

The tone generator block is what actually produces sound in response to the MIDI messages received from the Sequencer block, Controller block, Arpeggio block and from the external MIDI instrument. The MIDI messages are assigned to sixteen independent channels, and the instrument is capable of simultaneously playing sixteen separate Parts, via the sixteen MIDI channels. However, the sixteen-channel limit can be overcome by using separate MIDI “ports,” each supporting sixteen channels. The tone generator block of this instrument can handle MIDI messages over Port 1.

Tone Generator block

Performances

A Performance is a single set of sounds consisting of multiple Parts. You can change sounds as desired by selecting the appropriate Performance. Each Performance has two types of parameters; parameters unique to each Part and parameters common to all Parts. You can edit the entire Performance in the Common/Audio Edit display ([page 159](#)).

Part structure of a Performance

A Performance consists of 16 Parts and you can create Performances (in which multiple Parts or Parts are combined—in a layer, or in other configurations) using the keyboard.

Parts

Internally, there are three Part types: Normal Parts (AWM2), Normal Parts (FM-X), and Drum Parts. Normal Parts (AWM2) are mainly pitched musical instrument type sounds that can be played over the full range of the keyboard. Normal Parts (FM-X) are also mainly pitched musical instrument type sounds, using FM synthesis. Drum Parts are mainly percussion/drum sounds that are assigned to individual notes. A Normal Part (AWM2) can consist of up to eight Elements, a Normal Part (FM-X) can consist of up to eight Operators, and a Drum Part can consist of up to 73 Drum Keys.

An Element/Operator/Drum Key is the basic, smallest unit for a Part. By combining multiple Elements/Operators/Keys, Parts can be created to produce even more realistic sounds or various richly textured types of sound. Each Part is created by editing parameters unique to each (Element Edit parameters/Operator Edit parameters/Key Edit parameters) and parameters common to all the Elements/Operators/Keys (Element Common Edit, Operator Common Edit, and Key Common Edit parameters.)

NOTE For instructions on editing a Normal Part (AWM2), see [page 66](#). For instructions on editing a Normal Part (FM-X), see [page 145](#). For instructions on editing a Drum Part, see [page 133](#).

Basic Structure

▶	Functional blocks
▶	Tone Generator block
	A/D Input block
	Sequencer block
	Arpeggio block
	Motion Sequencer block
	Effect block
	Envelope Follower block
	Controller block
	Internal Memory

Reference

Display (touch panel) config.
Performance Play (Home)
Motion Control
Mixing
Scene
Play/Rec
Normal Part (AWM) Edit
Drum Part Edit
Normal Part (FM-X) Edit
Common/Audio Edit
Category Search
Utility
Live Set
iPhone/iPad connection

Normal Parts (AWM2), Normal Parts (FM-X), and Drum Parts

Normal Parts (AWM2)

These Parts are played conventionally from the keyboard, with standard pitches sounding for each key, generated by AWM2. A Normal Part consists of up to eight Elements. Depending on the settings in the Part Edit, these Elements are sounded simultaneously, or different Elements are sounded according to the note range, velocity range and the XA (Expanded Articulation) settings (page 6).

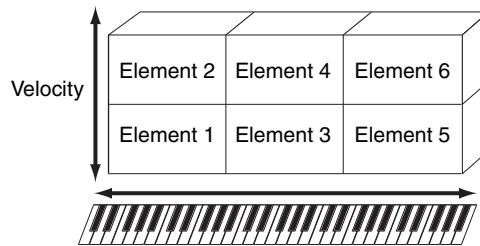

The illustration shows an example of a Normal Part (AWM2). Since the six Elements here are distributed across both the note range of the keyboard and the velocity range, a different Element sounds depending on which note you play and how strongly you play it. In the velocity distribution, Elements 1, 3 and 5 sound when playing the keyboard softly, while Elements 2, 4 and 6 sound when playing it strongly. In the note distribution, Elements 1 and 2 sound in the lower range of the keyboard, Elements 3 and 4 sound in the middle range, and Elements 5 and 6 sound in the higher range. In the velocity distribution, Elements 1, 3 and 5 sound when playing the keyboard softly, while Elements 2, 4 and 6 sound when playing it strongly. In a practical example of this in use, a piano Part could be composed of six different samples. Elements 1, 3 and 5 would be the sounds of the piano played softly, over the respective note ranges, while Elements 2, 4 and 6 would be strongly played sounds, for each respective note range. Actually, this instrument is even more flexible than this, since it allows up to eight independent Elements.

Normal Parts (FM-X)

These Parts are also played conventionally from the keyboard, with standard pitches sounding for each key, generated by FM synthesis. The sound for a Normal Part (FM-X) is created by modulating a frequency of a fundamental waveform with another waveform. An operator that generates a fundamental waveform is a “carrier,” and an operator that modulates these waveforms is a “modulator.” The combination of a number of Operators is called “Algorithm.”

When the waveform output from the Operator is a simple sine wave, no harmonics are included other than the fundamental tone. However, you can create harmonics by modulating the waveform with other Operators. How harmonics can be created depends on the Modulators’ output levels and the frequency rates of Carriers and Modulators. On the other hand, the basic pitch is determined by Carrier’s frequency, and the output level is determined by the Carrier’s output level. The figure described below shows a basic way to create FM sound by using an analog synthesizer.

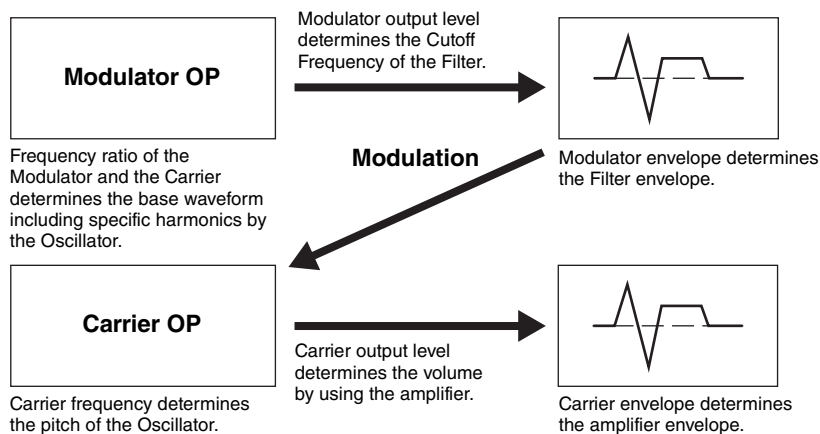

Although the figure described above shows waveforms which are generated by two operators, the MODX has eight Operators. The combination of a number of Operators is called an “Algorithm” and this synthesizer has parameters for setting the Algorithm.

Drum Parts

Drum Parts are mainly percussion/drum sounds that are assigned to individual notes on the keyboard (C0 to C6). Unlike Elements, a Drum key is equivalent to the corresponding note, meaning that you cannot change its range. Drum or percussion sounds are assigned to each Drum Key. You can create various types of Drum Parts by changing the drum or percussion sound assigned to each key and edit the parameters such as pitch and EG.

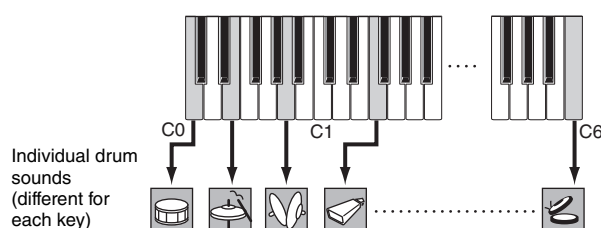

Basic Structure

Functional blocks
▶ Tone Generator block
A/D Input block
Sequencer block
Arpeggio block
Motion Sequencer block
Effect block
Envelope Follower block
Controller block
Internal Memory

Reference

Display (touch panel) config.
Performance Play (Home)
Motion Control
Mixing
Scene
Play/Rec
Normal Part (AWM) Edit
Drum Part Edit
Normal Part (FM-X) Edit
Common/Audio Edit
Category Search
Utility
Live Set
iPhone/iPad connection

Expanded Articulation (XA)

Expanded Articulation (XA) is a tone generation system that provides greater performance flexibility and acoustic realism. This feature allows you to more effectively recreate realistic sound and natural performance techniques—such as legato and staccato—and provides other unique modes for random and alternate sound changes as you play.

Realistic legato performance

This instrument more accurately reproduces a legato effect by allowing specific Elements to be sounded when playing legato and other Elements to be played normally (with the XA Control parameter settings “Normal” and “Legato”).

Authentic note release sound

The MODX reproduces these special, characteristic sounds by setting the XA Control parameter of certain Elements to “Key Off.”

Subtle sound variations for each note played

The MODX more accurately reproduces these subtle sound variations by using the XA Control parameter settings “Cycle” and “Random.”

Switching among different sounds to recreate the natural performance on an acoustic instrument

Acoustic instruments have their own unique characteristics—even specific, unique sounds that are produced only at certain times in a performance. These include the flutter tonguing on a flute or the playing of high harmonics on an acoustic guitar. The MODX recreates these by allowing you to switch between the sounds while you play—using the [ASSIGN 1]/[ASSIGN 2] buttons and the XA Control parameter settings, “A.SW1 On,” “A.SW2 On” and “A.SW Off.”

NOTE You can turn the [ASSIGN 1]/[ASSIGN 2] button on or off also by transmitting the Control Change number specified in the Common/Audio Edit display ([Control] → [Control Number]) ([page 167](#)) from an external device.

New sounds and new styles of playing

The highly versatile functions above can be applied effectively not only to acoustic sounds but also to synthesizer and electronic Parts as well. The XA feature opens up enormous potential for realizing authentic sounds, performing expressively and coming up with creative new styles of playing.

Motion Control System

The Motion Control System is a completely new feature for variably controlling Motions (rhythmical, multidimensional sound changes) in real time. This amazingly powerful feature dramatically and dynamically alters the sounds of the instrument in new, never-heard-before ways—changing texturally, rhythmically with the beats, providing cool, colorful lighting effects, and responding expressively to your creative passion. The Motion Control System has three main functions:

Super Knob:

For creating multi-dimensional sonic changes, and enhancing those changes with colorful, continually shifting lighting changes. Multiple parameters can be controlled simultaneously.

Motion Sequencer:

For continually variable sound changes. The powerful Motion Sequencer feature lets you dynamically change sounds by operating Parameters depending on sequences created in advance. It provides real time control for changing sounds depending on various sequences such as Tempo, Arpeggio, or the rhythm of external connected devices.

Envelope Follower:

Envelope Follower is a function for detecting the volume envelope of the input signal waveform and modifying sounds dynamically.

NOTE Envelope Follower can be controlled not only by the audio signal from an external device, but also by the output of all Parts.

Basic Structure

Functional blocks
▶ Tone Generator block
A/D Input block
Sequencer block
Arpeggio block
Motion Sequencer block
Effect block
Envelope Follower block
Controller block
Internal Memory

Reference

Display (touch panel) config.
Performance Play (Home)
Motion Control
Mixing
Scene
Play/Rec
Normal Part (AWM) Edit
Drum Part Edit
Normal Part (FM-X) Edit
Common/Audio Edit
Category Search
Utility
Live Set
iPhone/iPad connection

Motion Control System Structure

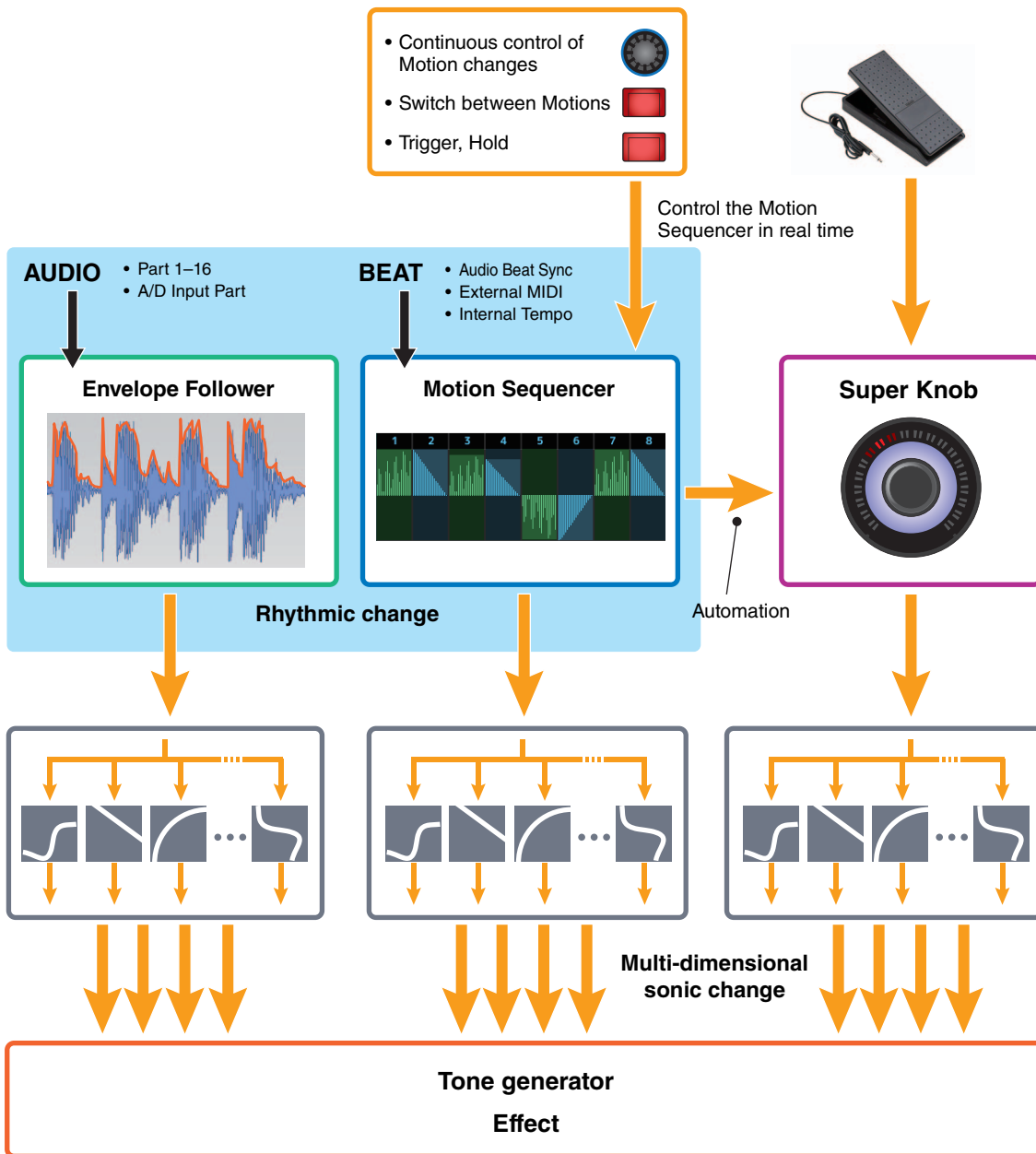

Basic Structure

Functional blocks
▶ Tone Generator block
A/D Input block
Sequencer block
Arpeggio block
Motion Sequencer block
Effect block
Envelope Follower block
Controller block
Internal Memory

Reference

Display (touch panel) config.
Performance Play (Home)
Motion Control
Mixing
Scene
Play/Rec
Normal Part (AWM) Edit
Drum Part Edit
Normal Part (FM-X) Edit
Common/Audio Edit
Category Search
Utility
Live Set
iPhone/iPad connection

For details on the Motion Control, refer to the website below:

<http://www.yamaha.com/modx/>

Elements, Drum Keys and Operators

Elements/Drum Keys/Operators are the smallest “building blocks” in the MODX that comprise a Part. These small sound units can be built, enhanced and processed by a variety of traditional synthesizer parameters, such as Pitch EG, Filter EG, Amplitude EG, and LFO (shown below).

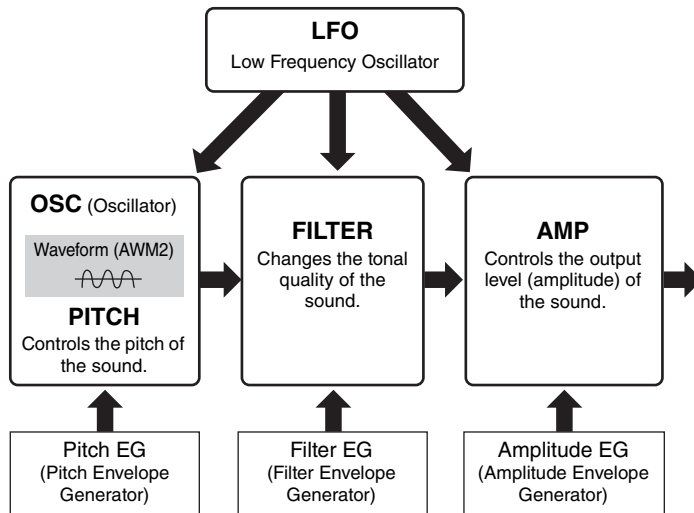

Oscillator

This unit allows you to assign the waveform (or basic sound material) to each Element/Operator/Key. Oscillator-related parameters can be set as follows.

- For Normal Parts (AWM2) and Drum Parts
[EDIT] → Part selection → Element selection → [Osc/Tune] ([page 107](#), [page 140](#))
- For Normal Parts (FM-X)
[EDIT] → Part selection → Operator selection → [Form/Freq] ([page 155](#))

Pitch

This unit allows you to control how the pitch changes over time. Pitch-related parameters can be set as follows.

- For Normal Parts (AWM2) and Drum Parts
[EDIT] → Part selection → Element selection → [Osc/Tune] ([page 107](#), [page 140](#))
- For Normal Parts (FM-X)
[EDIT] → Part selection → Operator [Common] → [Pitch/Filter] ([page 148](#))

Parameters related to Pitch EG can be set as follows.

- For Normal Parts (AWM2)
[EDIT] → Part selection → Element selection → [Pitch EG] ([page 111](#))
- For Normal Parts (FM-X)
[EDIT] → Part selection → Operator [Common] → [Pitch/Filter] ([page 148](#))

Filter

This unit modifies the tone of the sound by cutting the output of a specific frequency portion of the sound. Also, by setting the FEG (Filter Envelope Generator), you can control how the Cutoff Frequency of the Filter changes over time. Parameters related to Filter and Filter EG can be set as follows.

- For Normal Parts (AWM2) and Drum Parts
[EDIT] → Part selection → Element selection → [Filter] ([page 113](#), [page 142](#))
- For Normal Parts (FM-X)
[EDIT] → Part selection → Operator [Common] → [Pitch/Filter] ([page 148](#))

Basic Structure

Functional blocks
▶ Tone Generator block
A/D Input block
Sequencer block
Arpeggio block
Motion Sequencer block
Effect block
Envelope Follower block
Controller block
Internal Memory

Reference

Display (touch panel) config.
Performance Play (Home)
Motion Control
Mixing
Scene
Play/Rec
Normal Part (AWM) Edit
Drum Part Edit
Normal Part (FM-X) Edit
Common/Audio Edit
Category Search
Utility
Live Set
iPhone/iPad connection

Amplitude

This unit controls the output level (amplitude) of the Element/Drum Key/Operator. Parameters related to Amplitude and Amplitude EG can be set as follows.

- For Normal Parts (AWM2)
[EDIT] → Part selection → Element selection → [Amplitude] ([page 121](#))
- For Drum Parts
[EDIT] → Part selection → Element selection → [Level/Pan] ([page 143](#))
- For Normal Parts (FM-X)
[EDIT] → Part selection → Operator selection → [Level] ([page 157](#))

LFO (Low Frequency Oscillator)

As its name suggests, the LFO produces a wave of a low frequency. These waves can be used to vary the pitch, filter or amplitude of each Element/Operator to create effects such as vibrato, wah and tremolo. There are two LFO types: Part LFO, which is common to all Elements/Operators, and Element LFO, which is unique for each Element. Parameters related to Part LFO can be set as follows.

- For Normal Parts (AWM2)
[EDIT] → Part selection → Element [Common] → [Mod/Control] → [Part LFO] ([page 96](#))
- For Normal Parts (FM-X)
[EDIT] → Part selection → Operator [Common] → [Mod/Control] → [Part LFO] or [2nd LFO] ([page 152](#))

Parameters related to Element LFO can be set as follows.

[EDIT] → Part selection → Element selection → [Element LFO] ([page 126](#))

Maximum Polyphony

Maximum polyphony refers to the highest number of notes that can be sounded simultaneously from the internal tone generator of the instrument.

The maximum polyphony of this synthesizer is 128 for AWM2 and 64 for FM-X. When the internal tone generator block receives a number of notes exceeding the maximum polyphony, previously played notes are cut off. Keep in mind that this may be especially noticeable with Parts not having decay. Furthermore, the maximum polyphony applies to the number of Elements/Drum Keys used, not the number of Parts. When Normal Parts (AWM2) that include up to eight Elements are used, the maximum number of simultaneous notes may be less than 128.

Basic Structure

Functional blocks
▶ Tone Generator block
A/D Input block
Sequencer block
Arpeggio block
Motion Sequencer block
Effect block
Envelope Follower block
Controller block
Internal Memory

Reference

Display (touch panel) config.
Performance Play (Home)
Motion Control
Mixing
Scene
Play/Rec
Normal Part (AWM) Edit
Drum Part Edit
Normal Part (FM-X) Edit
Common/Audio Edit
Category Search
Utility
Live Set
iPhone/iPad connection

A/D Input Block

This block handles the audio signal input from the A/D INPUT [L/MONO]/[R] jacks. Various parameters such as volume, pan, and effect can be set for the audio signal and the sound is output together with other Parts. An Insertion Effect, the System Effects, the Master Effects, and the Master EQ can be applied to the audio signal input via the A/D INPUT [L/MONO]/[R] jacks.

Parameters related to the A/D Input block can be set as follows.

[PERFORMANCE (HOME)] → [Mixing] (page 50)
[EDIT] → Part [Common] → [Audio In] → [Mixing] (page 161)

The Effect which is applied to the audio signal input from the A/D INPUT [L/MONO]/[R] jacks can be set as follows.

[EDIT] → Part [Common] → [Audio In] → [Routing] (page 162)

The gain of the audio signal from the A/D INPUT [L/MONO]/[R] jacks can be adjusted via the A/D INPUT [GAIN] knob on the panel. Moreover, the on/off setting of the audio signal from the A/D INPUT [L/MONO]/[R] jacks can be turned on/off via the A/D INPUT [ON/OFF] button.

[UTILITY] → [Settings] → [Audio I/O] → "A/D Input" (page 190)

Sequencer Block

This lets you create Songs by recording and editing your performances as MIDI data (from the controller block or an external device), allowing you to play the data back with the tone generator block.

Songs

A Song is created by recording your keyboard performance as MIDI sequence data to individual Tracks. The MODX can store up to 128 Songs.

Tracks

This is a memory location on the sequencer where your musical performances are stored. One Part can be recorded to one track. Since the MODX has 16 tracks for one Song, you can record and play back a 16-Part performance.

MIDI recording

You can record your keyboard performance to the Song. You can record knob operations, controller operations and Arpeggio playback as well as your keyboard playing to the specified Track as MIDI events. Your keyboard performance and controller/knob operations will be recorded to the Track when the corresponding Keyboard Control Switch for the Part is turned ON.

NOTE The Control Change messages and Parameter Change messages can be recorded by operating the Knobs. For details on Control Change messages, see the Synthesizer Parameter Manual PDF document.

NOTE For detailed instruction, refer to the Owner's Manual.

Basic Structure

Functional blocks
Tone Generator block
▶ A/D Input block
▶ Sequencer block
Arpeggio block
Motion Sequencer block
Effect block
Envelope Follower block
Controller block
Internal Memory

Reference

Display (touch panel) config.
Performance Play (Home)
Motion Control
Mixing
Scene
Play/Rec
Normal Part (AWM) Edit
Drum Part Edit
Normal Part (FM-X) Edit
Common/Audio Edit
Category Search
Utility
Live Set
iPhone/iPad connection

Arpeggio Block

This block lets you automatically trigger musical and rhythmic phrases by simply pressing a note or notes on the keyboard. Yamaha's Arpeggio sequence also changes in response to the actual notes or chords you play, giving you a wide variety of inspiring musical phrases and ideas—both in composing and performing.

Arpeggio categories

The Arpeggio types are divided into 18 categories (including “No Assign” and “Control/Hybrid Seq”) as listed below. The categories are based on instrument type.

Arpeggio Type Category List

Piano	Piano	Pad	Pad/Choir
Keys	Keyboard	SynCp	Syn Comp
Organ	Organ	CPerc	Chromatic Perc
Gtr	Guitar	Dr/Pc	Drum/Perc
Bass	Bass	S.FX	Sound FX
Str	String	M.FX	Musical FX
Brass	Brass	Ethnc	Ethnic
WW	Woodwind	---	No Assign
SynLd	Syn Lead	Ct/Hb	Control / Hybrid Seq

Sub categories

The Arpeggio categories are divided into the sub categories listed below. Because the sub categories are listed based on the music genre, it is easy to find the sub category appropriate for your desired music style.

Arpeggio Type Sub Category List

Rock	Rock	World	World
Pop Rock	Pop Rock	General	General
Ballad	Ballad	No Assign	No Assign
Chill	Chillout / Ambient	Filter	Filter *
Hip Hop	Hip Hop	Exprs	Expression *
Funk	Funk	Pan	Pan *
Modern R&B	Modern R&B	Mod	Modulation *
Classic R&B	Classic R&B	PBend	Pitch Bend *
House	House / Dance Pop	Assign	Assign 1/2 *
Techno	Techno / Trance	Comb	Comb *
Jazz	Jazz / Swing	Zone	Zone Velocity *
D&B	D&B / Breakbeats	Z.Pad	Zone Vel for Pad *
Latin	Latin		

NOTE In the Category Search display, the Sub Categories marked with an asterisk (*) are displayed only when “Control/Hybrid Seq” is selected as the Category type.

Basic Structure

Functional blocks
Tone Generator block
A/D Input block
Sequencer block
▶ Arpeggio block
Motion Sequencer block
Effect block
Envelope Follower block
Controller block
Internal Memory

Reference

Display (touch panel) config.
Performance Play (Home)
Motion Control
Mixing
Scene
Play/Rec
Normal Part (AWM) Edit
Drum Part Edit
Normal Part (FM-X) Edit
Common/Audio Edit
Category Search
Utility
Live Set
iPhone/iPad connection

Arpeggio Type Name

The Arpeggio Types are named according to certain rules and abbreviations. Once you understand these rules and abbreviations, you'll find it easy to browse through and select the desired Arpeggio Types.

Arpeggio types with “_N” at the end of the type name (example: HipHop1_N)

These Arpeggios are for using with the Normal Part, and Arpeggios with complex notes can be created even when triggered by one note (page 14).

Arpeggio types with “_C” at the end of the type name (example: Rock1_C)

These Arpeggios are for using with the Normal Part, and correct Arpeggios can be created corresponding to the chord you play (page 14).

Arpeggio types with a normal name (example: UpOct1)

In addition to the above types, there are three playback types: the Arpeggios created for use of Normal Parts and played back using only the played notes and their octave notes (page 14), the Arpeggios created for use of Drum Parts (page 15), and Arpeggios containing mainly non-note events (page 15).

Arpeggio types with “_AF1”, “_AF2”, or “_AF1&2” at the end of the type name (example: Electro Pop AF1)

When these Arpeggios are played, both of [ASSIGN 1] and [ASSIGN 2] buttons are automatically turned ON and the phrase starts playback.

Arpeggio types with [Mg] at the beginning of the type name (example: [Mg]HardRock1)

These Arpeggios are for using with a Mega Voice.

Basic Structure

Functional blocks
Tone Generator block
A/D Input block
Sequencer block
▶ Arpeggio block
Motion Sequencer block
Effect block
Envelope Follower block
Controller block
Internal Memory

Reference

Display (touch panel) config.
Performance Play (Home)
Motion Control
Mixing
Scene
Play/Rec
Normal Part (AWM) Edit
Drum Part Edit
Normal Part (FM-X) Edit
Common/Audio Edit
Category Search
Utility
Live Set
iPhone/iPad connection

Mega Voices and Mega Voice Arpeggios

Normal sound uses velocity switching to make the sound quality and/or level of a Part change according to how strongly or softly you play the keyboard—giving greater authenticity and natural response to these Parts. However Mega Voices have a very complex structure with many different layers that are not suitable for playing manually. Mega Voices were developed specifically to be played by Mega Voice Arpeggios to produce incredibly realistic results. You should always use Mega Voices with Mega Voice Arpeggios.

The Arpeggio Type List in the Data List PDF document contains the following columns.

①	②	③	④	⑤	⑥	⑦	⑧	⑨	⑩
Main Category	Sub Category	ARP No.	ARP Name	Time Signature	Length	Original Tempo	Accent	Random SFX	Sound Type
ApKb	Rock	1	MA_70s Rock_ES	4 / 4	2	130			Acoustic Piano
ApKb	Rock	2	MB_70s Rock_ES	4 / 4	1	130			
ApKb	Rock	3	MC_70s Rock	4 / 4	2	130			
ApKb	Rock	4	MD_70s Rock	4 / 4	4	130			
ApKb	Rock	5	FA_70s Rock	4 / 4	1	130			
ApKb	Rock	6	FB_70s Rock_ES	4 / 4	1	130			
ApKb	Rock	7	FC_70s Rock_ES	4 / 4	2	130			

NOTE Note that this list is for illustration purposes only. For a complete listing of the Arpeggio Types, see the Data List PDF document.

① Main Category

Indicates an Arpeggio Main Category.

② Sub Category

Indicates an Arpeggio Sub Category.

③ ARP No (Arpeggio Number)

Indicates the Arpeggio type number.

④ ARP Name (Arpeggio Name)

Indicates the Arpeggio Name.

5 Time Signature

Indicates the time signature or meter of the Arpeggio type.

6 Length

Indicates the data length (amount of measures) of the Arpeggio type. When the Loop parameter*1 is set to "off," the Arpeggio plays back for this length and stops.

7 Original Tempo

Indicates the appropriate tempo value of the Arpeggio type. Note that this tempo is not set automatically when selecting an Arpeggio type.

8 Accent

The circle indicates that the Arpeggio uses the Accent Phrase feature (page 14).

9 Random SFX

The circle indicates that the Arpeggio uses the SFX feature (page 14).

10 Sound Type

Indicates the sound type appropriate for the Arpeggio Type.

*1 The Loop parameter is set as follows.

[EDIT] → Part Selection → Element/Operator [Common] → [Arpeggio] → [Common] (page 82)

Arpeggio-related settings

There are several methods for triggering and stopping the Arpeggio playback. In addition, you can set whether or not SFX sounds and special Accent Phrases are triggered along with the normal sequence data.

Turning Arpeggio playback on/off

The following three settings are available for turning the Arpeggio playback on/off.

To play the Arpeggio only when the note is pressed:	Set the "Hold" parameter to "Off" and the "Trigger Mode" parameter to "Gate."
To continue the Arpeggio even if the note is released:	Set the "Hold" parameter to "On" and the "Trigger Mode" parameter to "Gate."
To toggle the Arpeggio playback on/off whenever the note is pressed:	Set the "Trigger Mode" parameter to "Toggle." The "Hold" parameter can be set to either "On" or "Off."

NOTE "Hold" is set as follows.

[EDIT] → Part Selection → Element/Operator [Common] → [Arpeggio] → [Common] (page 82)

NOTE When receiving a MIDI sustain message (control change #64) with both of "Arp Master" and "Arp Part" set to "On," you can obtain the same result by setting "Hold" to "On."

NOTE "Trigger Mode" is set as follows.

[EDIT] → Part Selection → Element/Operator [Common] → [Arpeggio] → [Advanced] (page 87)

Using the Knobs to control Arpeggios

By pressing the Knob Function [TONE]/[EG/FX]/[EQ]/[ARP/MS] button and selecting "ARP/MS," you can use the Knobs 1–2 to control Arpeggio playback. Try this out and listen for the changes in the sound. For details regarding the effect of the Knobs 1–2, see Quick Edit (page 37).

Arpeggio functions which can be controlled by Knob operations

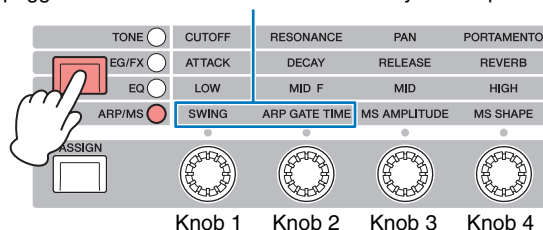

Basic Structure

Functional blocks
Tone Generator block
A/D Input block
Sequencer block
▶ Arpeggio block
Motion Sequencer block
Effect block
Envelope Follower block
Controller block
Internal Memory

Reference

Display (touch panel) config.
Performance Play (Home)
Motion Control
Mixing
Scene
Play/Rec
Normal Part (AWM) Edit
Drum Part Edit
Normal Part (FM-X) Edit
Common/Audio Edit
Category Search
Utility
Live Set
iPhone/iPad connection

Accent Phrases

Accent Phrases are composed of sequence data included in some Arpeggio types, sounding only when you play notes at a velocity higher (stronger) than that specified in the Accent Velocity Threshold parameter.

If it is hard to play at velocities necessary to trigger the Accent Phrase, set the “Vel Threshold” (Accent Velocity Threshold) parameter to a lower value.

NOTE “Vel Threshold” (Accent Velocity Threshold) parameter is set as follows.
[EDIT] → Part Selection → Element/Operator [Common] → [Arpeggio] → [Advanced] (page 87)

NOTE For information on Arpeggio types that use this function, refer to the “Arpeggio Type List” in the Data List PDF document.

Random SFX

Some Arpeggio types feature a Random SFX function which will trigger special sounds (such as guitar fret noises) when the note is released. The following parameters affecting Random SFX are provided.

For turning the Random SFX on/off:	Random SFX parameter
For setting the volume of the SFX sound:	Velocity Offset (Random SFX Velocity Offset) parameter
For determining whether or not the volume of the SFX sound is controlled by velocity:	Key On Ctrl (Random SFX Key on Control) parameter

NOTE “Random SFX,” “Velocity Offset,” and “Key On Ctrl” are set as follows.
[EDIT] → Part Selection → Element/Operator [Common] → [Arpeggio] → [Advanced] (page 87)

NOTE The Random SFX function is not available for the Arpeggio which stops when the note is released.

NOTE For information on Arpeggio types that use the Random SFX function, refer to the “Arpeggio Type List” in the Data List PDF document.

Arpeggio playback types

There are three main Arpeggio playback types as described below.

Arpeggios for Normal Parts

Arpeggio types (belonging to all categories except for Drum/Perc and a part of Control/HybridSeq) created for use of Normal Parts have the following three playback types.

Playback of played notes only

The Arpeggio is played back using only the played note(s) and octave notes.

Playback of a programmed sequence according to the played notes

These Arpeggio types have the several sequences each of which is suited for a certain chord type. Even if you press only one note, the Arpeggio is played back using the programmed sequence—meaning that notes other than the ones you play may be sounded. Pressing another note triggers a transposed sequence using the pressed note as the new root note. Adding notes to those already held changes the sequence accordingly. Arpeggios with this playback type have “_N” at the end of the type name.

Playback of a programmed sequence according to the played chord

These Arpeggio types created for use with Normal Parts are played back to match the chord type determined by detecting the notes you play on the keyboard. Arpeggios with this playback type have “_C” at the end of the type name.

NOTE When the “Key Mode” parameter is set to “Sort” or “Sort+Drct,” the same sequence is played back no matter what order you play the notes. When the “Key Mode” parameter is set to “Thru” or “Thru+Drct,” a different sequence is played back depending on the order you play the notes.

NOTE Since these types are programmed for Normal Parts, using them with Drum Parts may not produce musically appropriate results.

Basic Structure

Functional blocks
Tone Generator block
A/D Input block
Sequencer block
▶ Arpeggio block
Motion Sequencer block
Effect block
Envelope Follower block
Controller block
Internal Memory

Reference

Display (touch panel) config.
Performance Play (Home)
Motion Control
Mixing
Scene
Play/Rec
Normal Part (AWM) Edit
Drum Part Edit
Normal Part (FM-X) Edit
Common/Audio Edit
Category Search
Utility
Live Set
iPhone/iPad connection

Arpeggios for Drum Parts

Arpeggio types in Drum/Perc categories are programmed specifically for use with Drum Parts, giving you instant access to various rhythm patterns. Three different playback types are available.

Playback of a drum pattern

Pressing any note(s) will trigger the same rhythm pattern.

Playback of a drum pattern, plus additional played notes (assigned drum instruments)

Pressing any note will trigger the same rhythm pattern. Adding notes to the one already held produces additional sounds (assigned drum instruments) for the drum pattern.

Playback only of the played notes (assigned drum instruments)

Playing a note or notes will trigger a rhythm pattern using only the notes played (assigned drum instruments). Keep in mind that even if you play the same notes, the triggered rhythm pattern differs depending on the order of the notes played. This gives you access to different rhythm patterns using the same instruments simply by changing the order in which you play the notes, when the “Key Mode” parameter is set to “Thru” or “Thru+Drct.”

NOTE The three playback types above are not distinguished by category name or type name. You'll have to actually play the types and hear the difference.

NOTE Since these types are programmed for Drum Parts, using them with Normal Parts may not produce musically appropriate results.

Arpeggios containing mainly non-note events

Arpeggio types (in Control/HybridSeq main categories with Filter, Expression, Pan, Modulation, Pitch Bend, and Assign 1/2 sub categories) are programmed primarily with Control Change and Pitch Bend data. They are used to change the tone or pitch of the sound, rather than play specific notes. In fact, some types contain no note data at all. When using a type of this category, set the “Key Mode” parameter to “Direct,” “Sort+Drct,” or “Thru+Drct.”

NOTE Settings related to Key Mode are set as follows.

[EDIT] → Part Selection → Element/Operator [Common] → [Arpeggio] → [Common] ([page 82](#))

Tips for Arpeggio playback

Arpeggios not only provide inspiration and full rhythmic passages over which you can perform, they give you quality MIDI data you can use in creating Songs, or fully formed backing parts to be used in your live performances. For instructions on using Arpeggio, see the Owner's Manual.

Basic Structure

Functional blocks
Tone Generator block
A/D Input block
Sequencer block
▶ Arpeggio block
Motion Sequencer block
Effect block
Envelope Follower block
Controller block
Internal Memory

Reference

Display (touch panel) config.
Performance Play (Home)
Motion Control
Mixing
Scene
Play/Rec
Normal Part (AWM) Edit
Drum Part Edit
Normal Part (FM-X) Edit
Common/Audio Edit
Category Search
Utility
Live Set
iPhone/iPad connection

Creating an Arpeggio

In addition to using the preset Arpeggios, you can also create your own original Arpeggio data. First, record a phrase to Song Tracks (up to a maximum of four). Then, convert the Song (or the MIDI sequence data) to Arpeggio data from the Put Track to Arpeggio display.

1 Record MIDI sequence data to a Song.

2 Convert the MIDI sequence data (recorded to the Song) to Arpeggio data.

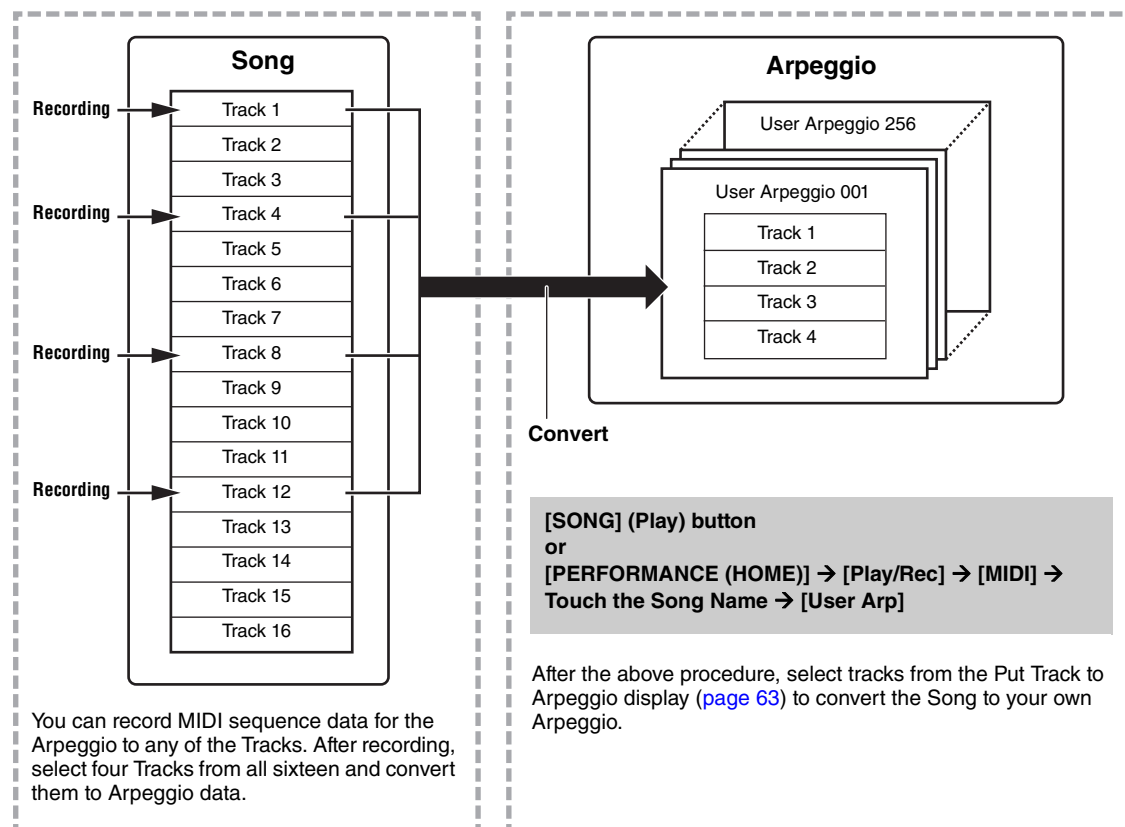

Determining how Song/Pattern data is converted to an Arpeggio – Convert Type

MIDI sequence data (of Song Tracks) can be converted to Arpeggio data in one of three ways, according to the Convert types below. These types can also be selected independently for each destination Track—providing enormous flexibility and performance control.

Normal (Normal Arpeggio)	The Arpeggio is played back using only the played note and its octave notes.
Fixed	Playing any note(s) will trigger the same MIDI sequence data.
OrgNotes (Original Notes)	Basically same as “Fixed” with the exception that the Arpeggio playback notes differ according to the played chord.

Record the MIDI sequence data to a Song Track, referring to the previous instructions in this chapter as needed. The examples listed below are used as reference.

Creating a rhythm pattern (using a Drum Voice)

Track 1	Record a basic rhythm pattern using various drum instruments.	Convert via “Fixed.”
Track 2–4	Record a different rhythm pattern using a specific drum instrument to each Track.	Convert via “Normal.”

Creating a bass line (using a Normal Voice)

Track 1	Record a bass line using a specific desired key (root).	Convert via “OrgNote” after the OrgNotes Root is set.
Track 2–4		off

Basic Structure

Functional blocks
Tone Generator block
A/D Input block
Sequencer block
▶ Arpeggio block
Motion Sequencer block
Effect block
Envelope Follower block
Controller block
Internal Memory

Reference

Display (touch panel) config.
Performance Play (Home)
Motion Control
Mixing
Scene
Play/Rec
Normal Part (AWM) Edit
Drum Part Edit
Normal Part (FM-X) Edit
Common/Audio Edit
Category Search
Utility
Live Set
iPhone/iPad connection

Motion Sequencer Block

The powerful Motion Sequencer feature lets you dynamically change sounds by operating Parameters depending on sequences created in advance.

It provides real time control for changing sounds depending on various sequences such as Tempo, Arpeggio, or the rhythm of external connected devices.

You can assign up to eight desired Sequence types for one Lane.

You can also set up to four Lanes corresponding to the Motion Sequencer function for one Part. Up to eight Lanes can be used at the same time for the entire Performance.

The setting status (on or off) the Lanes in the entire Performance will be shown as follows.

[PERFORMANCE (HOME)] → [Motion Control] → [Motion Seq] (page 44)

Also, the parameters for each Lane are set as follows.

[PERFORMANCE (HOME)] → [EDIT] → Part selection → Element/Operator [Common] → [Motion Seq] → [Lane] (page 91)

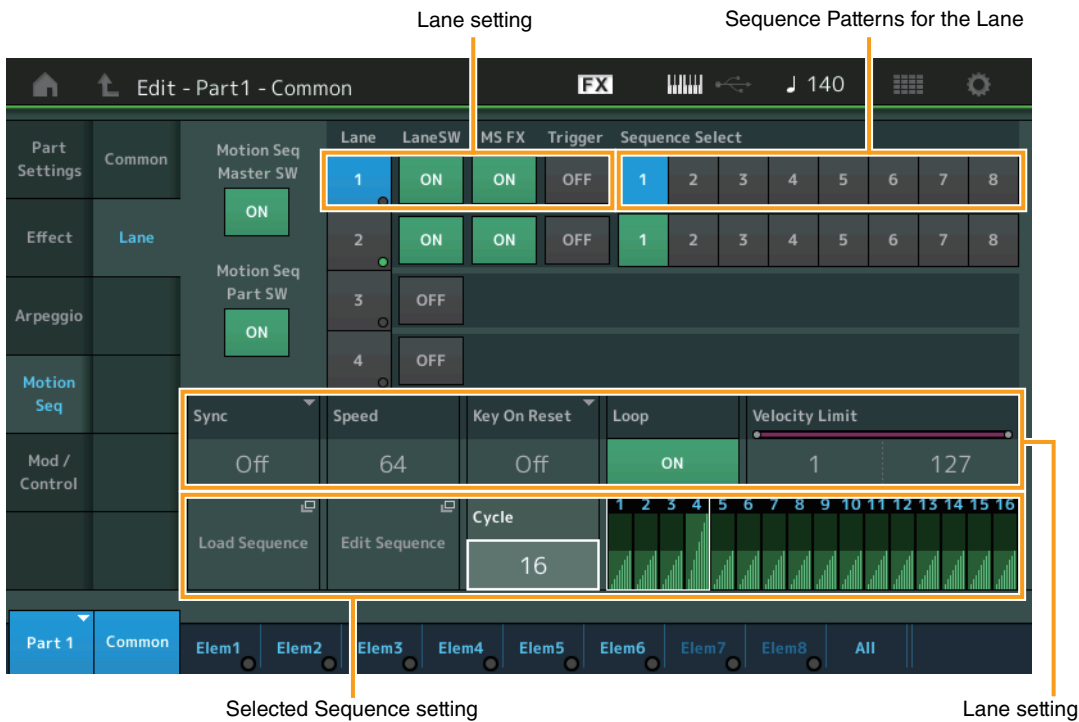

Basic Structure

Functional blocks
Tone Generator block
A/D Input block
Sequencer block
Arpeggio block
▶ Motion Sequencer block
Effect block
Envelope Follower block
Controller block
Internal Memory

Reference

Display (touch panel) config.
Performance Play (Home)
Motion Control
Mixing
Scene
Play/Rec
Normal Part (AWM) Edit
Drum Part Edit
Normal Part (FM-X) Edit
Common/Audio Edit
Category Search
Utility
Live Set
iPhone/iPad connection

Turning the Motion Sequencer on/off

The following settings are available for turning the Motion Sequencer playback on/off.

To play the Motion Sequence when the note is pressed:	Set the "LaneSW" parameter to "On," the "Trigger" parameter to "Off," and the "Sync" parameter to "Off."
To play the Motion Sequence when the [MOTION SEQ TRIGGER] button is pressed:	Set the "LaneSW" parameter to "On," the "Trigger" parameter to "On," and the "Sync" parameter to "Off."

NOTE "LaneSW" and "Trigger" are set as follows.

[EDIT] → Part selection → Element/Operator [Common] → [MOTION Seq] → [Lane] (page 91)

Using the Knobs to control Motion Sequencer

By pressing the Knob Function [TONE]/[EG/FX]/[EQ]/[ARP/MS] button and selecting “ARP/MS,” you can use the Knobs 3–4 to control Motion Sequencer playback. Try this out and listen for the changes in the sound. For details regarding the effect of the Knobs 3–4, see Quick Edit ([page 37](#)).

Motion Sequencer functions which can be controlled by Knob operations

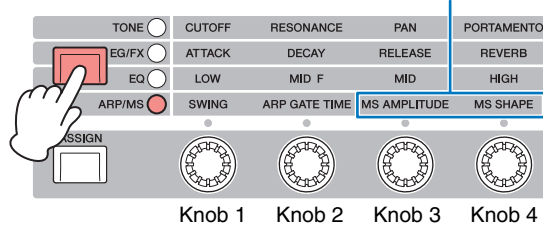

Editing Motion Sequences

You can create a custom Motion Sequence consisting of up to sixteen steps. For details about Editing, see [page 93](#).

Parameters related to Motion Sequencer

In this instrument, Motion Sequencer is considered as a virtual controller and can be selectable in the “Source” parameter. The target parameter you want to control by Motion Sequencer is set in the “Destination” parameter. For details, see [page 100](#).

Basic Structure

Functional blocks
Tone Generator block
A/D Input block
Sequencer block
Arpeggio block
▶ Motion Sequencer block
Effect block
Envelope Follower block
Controller block
Internal Memory

Reference

Display (touch panel) config.
Performance Play (Home)
Motion Control
Mixing
Scene
Play/Rec
Normal Part (AWM) Edit
Drum Part Edit
Normal Part (FM-X) Edit
Common/Audio Edit
Category Search
Utility
Live Set
iPhone/iPad connection

Effect Block

This block applies effects to the output of the tone generator block as well as audio input block, processing and enhancing the sound. Effects are applied in the final stages of editing, letting you change the sound as desired.

Effect structure

System Effects—Variation and Reverb

System Effects are applied to the overall sound. With System Effects, the sound of each Part is sent to the effect according to the Effect Send Level for each Part. The processed sound (referred to as “wet”) is sent back to the mixer according to the Return Level, and output—after being mixed with the unprocessed “dry” sound. This instrument is equipped with Variation and Reverb as System Effects. In addition, you can set the Send Level from Variation to Reverb. This parameter is used to apply Reverb to the signals output from the Variation. You can get a natural effect by applying Reverb depth to the Variation sound with the same level as that of the dry sound.

Insertion Effects

Insertion Effects can be applied individually to each of specified parts before merging signals of all parts. It should be used for sounds for which you want to drastically change the character. You can set different Effect types to the Insertion Effects A and B for each Part. These settings can be made from Part Edit → [Effect] (page 75, page 136, page 150).

This synthesizer features 13 sets of Insertion Effects. They can be applied to Parts 1–8 and four of the Parts 9–16 and A/D Input Part.

Master Effect

This block applies effects to the final stereo output signal of the entire sound. Multiple Effect types are available.

Element EQ

Element EQ is applied to each Element of the Normal Part (AWM2) and each key of the Drum Part. You can specify one of three different EQ shapes, including shelving and peaking.

NOTE Element EQ does not affect the Input signals from the A/D INPUT [L/MONO]/[R] jacks.

Part EQ

This EQ is applied to a Part before and after the Insertion Effect.

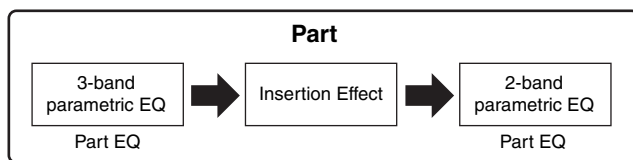

Master EQ

Master EQ is applied to the final (post-effect), overall sound of the instrument. In this EQ, all five bands can be set to peaking, with shelving being available also for the lowest and highest bands.

Basic Structure

Functional blocks
Tone Generator block
A/D Input block
Sequencer block
Arpeggio block
Motion Sequencer block
▶ Effect block
Envelope Follower block
Controller block
Internal Memory

Reference

Display (touch panel) config.
Performance Play (Home)
Motion Control
Mixing
Scene
Play/Rec
Normal Part (AWM) Edit
Drum Part Edit
Normal Part (FM-X) Edit
Common/Audio Edit
Category Search
Utility
Live Set
iPhone/iPad connection

Effect connection

1 Each EQ and Insertion Effect applied to each Part

2 Variation and Reverb related parameters

Setting: Part Edit → [Effect] → [Routing] (page 75, page 136, page 150)
Common/Audio Edit → [Effect] → [Routing] (page 169)

3 Master Effect related parameters

Setting: Common/Audio Edit → [Effect] → [Master FX] (page 172)

4 Master EQ related parameters

Setting: Common/Audio Edit → [Effect] → [Master EQ] (page 173)

NOTE Regarding the audio input signal from the A/D INPUT [L/MONO]/[R] jacks, the effect is set in Common/Audio Edit → [Audio In].

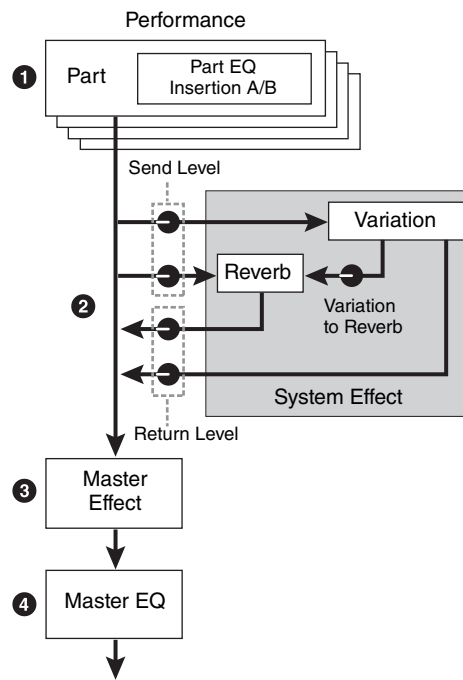

About the Vocoder Effect

MODX features a Vocoder effect. Vocoder is a distinctive, “robot voice” effect which extracts the characteristic of the microphone sound and adds it to the sound via your keyboard performance. The human voice consists of sounds generated from the vocal cords, and filtered by the throat, nose and mouth. These resonant sections have specific frequency characteristics and they function effectively as a filter, creating many formants (harmonic content). The Vocoder effect extracts the filter characteristics of the voice from the microphone input and recreates the vocal formants by the use of multiple band pass filters. The machine-like ‘robot’ voice is created by passing the pitched sounds of musical instruments (such as a synthesizer sound) through the filters.

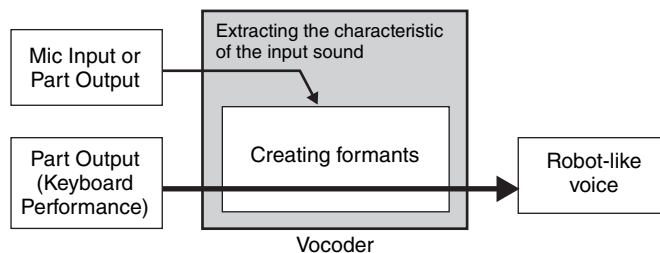

Basic Structure

Functional blocks
Tone Generator block
A/D Input block
Sequencer block
Arpeggio block
Motion Sequencer block
▶ Effect block
Envelope Follower block
Controller block
Internal Memory

Reference

Display (touch panel) config.
Performance Play (Home)
Motion Control
Mixing
Scene
Play/Rec
Normal Part (AWM) Edit
Drum Part Edit
Normal Part (FM-X) Edit
Common/Audio Edit
Category Search
Utility
Live Set
iPhone/iPad connection

About Effect categories, Effect types, and Effect parameters

For information regarding the effect categories of this instrument and the effect types contained in their categories, see the “Effect Type List” in the Data List PDF document. For information on the effect parameters which can be set in the each effect type, see the “Effect Parameter List” in the Data List PDF document. For information on the descriptions of each effect category, each effect type, and each effect parameter, see the Synthesizer Parameters Manual PDF document.

About Preset settings

Preset settings for parameters of each effect type are provided as templates and can be selected in the Effect Type selection display. To get a desired effect sound, try first selecting one of the Presets close to your imagined sound, then change the parameters as necessary. Preset settings can be determined by setting “Preset” in each effect parameter display. For information on each effect type, see the Data List PDF document.

Envelope Follower Block

Envelope Follower is a function for detecting the envelope of the input signal waveform and modifying sounds dynamically. This function allows you to control not only Part outputs but also input signals from external devices connected to the A/D INPUT [L/MONO]/[R] jacks.

The Input source of each Envelope Follower is fixed such as Part 1 for EnvFollower 1, Part 2 for EnvFollower 2, and the Audio Part for EnvFollower AD. However, the signal output from each Envelope Follower can be another “input source” for any desired destination such as each Part or even the entire Performance. For example, you can modify the sound of Part 2 by using the Envelope Follower for Part 1 (EnvFollower 1) as the “Source.” The Envelope Follower as the “Source” and the target parameter to be controlled by the Envelope Follower (which is called “Destination”) are set in the Control Assign display (page 100).

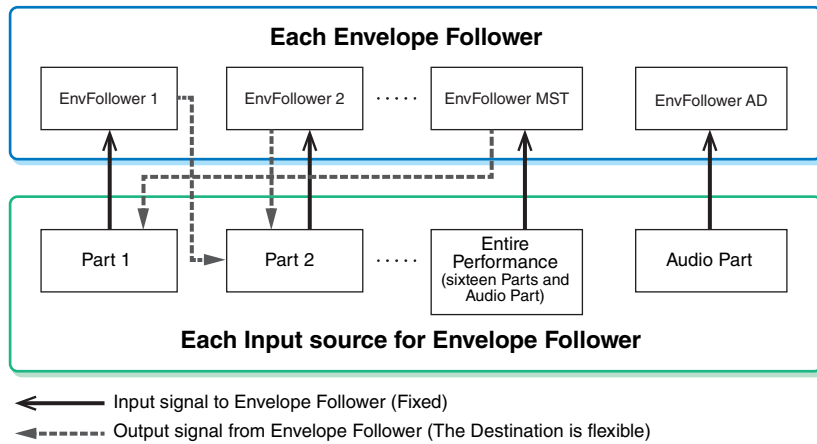

Selected Envelope Follower



Signal flow of Envelope Follower

Input sources for Envelope Follower

[EDIT] → Common/Audio Edit → [Audio In] → [Routing] → “Envelope Follower” (EnvFollower AD)

[EDIT] → Common/Audio Edit → [Effect] → [Routing] → “Envelope Follower” (EnvFollower MST)

[EDIT] → Part selection → Element/Operator [Common] → [Effect] → [Routing] → “Envelope Follower” (EnvFollower 1–16)

Basic Structure

Functional blocks
Tone Generator block
A/D Input block
Sequencer block
Arpeggio block
Motion Sequencer block
Effect block
▶ Envelope Follower block
Controller block
Internal Memory

Reference

Display (touch panel) config.
Performance Play (Home)
Motion Control
Mixing
Scene
Play/Rec
Normal Part (AWM) Edit
Drum Part Edit
Normal Part (FM-X) Edit
Common/Audio Edit
Category Search
Utility
Live Set
iPhone/iPad connection

Controller Block

This block consists of the keyboard, Pitch Bend and Modulation Wheels, Assignable Switches, Knobs, Control Sliders and Super Knob. By operating these controllers, you can transmit MIDI messages to the tone generator block to play and modify sounds, or to the DAW software to further control the sounds.

Keyboard

The keyboard transmits the note on/off messages to the Tone Generator Block (for sounding) and Sequencer Block (for recording). You can change the note range of the keyboard in octaves by using the OCTAVE [-]/[+] buttons, transpose the notes by using the OCTAVE [-]/[+] buttons while holding down the [SHIFT] button, and set how the actual velocity is generated according to the strength with which you play notes.

Pitch Bend wheel

Use the Pitch Bend wheel to bend notes up (roll the wheel away from you) or down (roll the wheel toward you) while playing the keyboard. Roll the wheel upward/downward to bend the pitch upward/downward. This wheel is self-centering and will automatically return to normal pitch when released. The Pitch Bend Range setting can be changed in Part Edit → [Part Settings] → [Pitch] ([page 68](#)). Functions other than Pitch Bend can be assigned to the Pitch Bend wheel in the Part Edit → [Mod/Control] → [Control Assign] ([page 100](#), [page 153](#)).

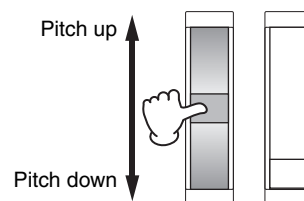

Modulation wheel

Even though the Modulation wheel is conventionally used to apply vibrato to the sound, many of the preset Performances have other functions and effects assigned to the wheel. The more you move this wheel up, the greater the effect that is applied to the sound. To avoid accidentally applying effects to the current Performance, make sure the Modulation wheel is set to minimum before you start playing. Various functions can be assigned to the Modulation wheel in Part Edit → [Mod/Control] → [Control Assign] ([page 100](#), [page 153](#)).

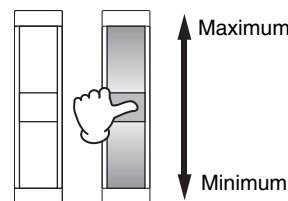

Assignable Switches

According to the XA (Expanded Articulation) Control settings ([page 6](#)) in Element Edit → [Osc/Tune] ([page 107](#)), you can call up specific Elements of the current Part by pressing each of these buttons during your keyboard performance. You can select how the on/off status of these buttons is switched in Common/Audio Edit → [General] ([page 159](#)). Furthermore, you can assign various functions (other than calling up specific Elements) to these buttons in Part Edit → [Mod/Control] → [Control Assign] ([page 100](#), [page 153](#)).

Knobs and Control Sliders

These knobs and sliders let you change various aspects of the Part's sound in real time—while you play. For instructions on using the knobs and control sliders, see the Owner's Manual. For instructions on using the Knobs 1–4 (5–8), see "Quick Edit" ([page 35](#)).

Super Knob

The Super Knob lets you simultaneously control the parameters common to all Parts (Assign 1–8) which are assigned to the eight knobs. For instructions on using the Super Knob, see the Owner's Manual. For the editable setting values for the Super Knob, see the Super Knob display ([page 45](#)). Also, for instructions on setting the Assign 1–8 controls, see the Control Assign display ([page 166](#)) for the Common/Audio Edit.

Basic Structure

Functional blocks
Tone Generator block
A/D Input block
Sequencer block
Arpeggio block
Motion Sequencer block
Effect block
Envelope Follower block
▶ Controller block
Internal Memory

Reference

Display (touch panel) config.
Performance Play (Home)
Motion Control
Mixing
Scene
Play/Rec
Normal Part (AWM) Edit
Drum Part Edit
Normal Part (FM-X) Edit
Common/Audio Edit
Category Search
Utility
Live Set
iPhone/iPad connection

Internal Memory

The MODX creates a variety of different kinds of data, including Performances, Live Sets, and Songs. This section describes how to maintain the various types of data and use the memory devices/media for storing them.

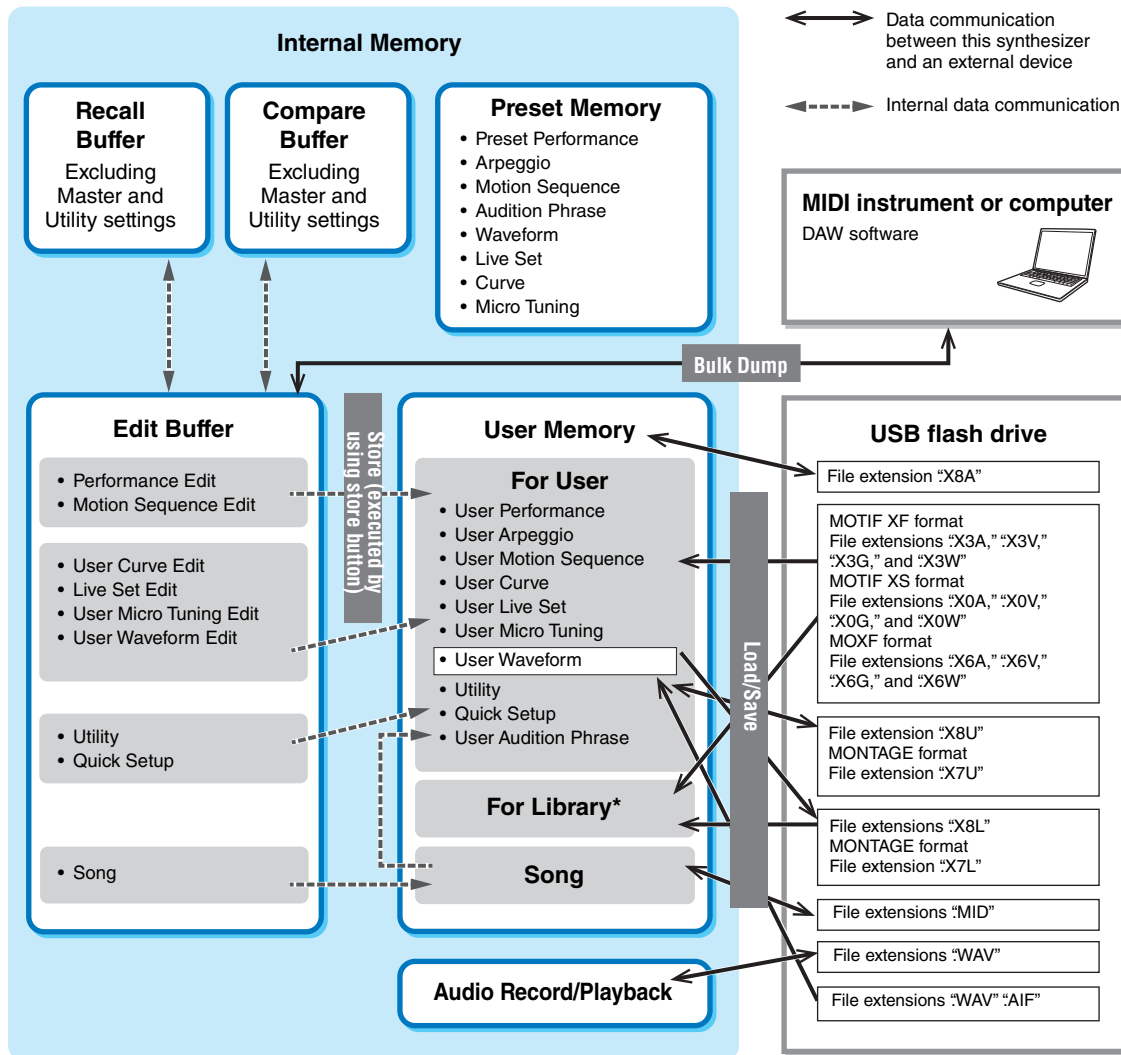

* Same as the "For User" area except followings: It does not include the Utility settings and the Quick Setup. Also, included Live Set is only one Bank for each imported file.

Preset Memory

Preset Memory is memory designed specifically for reading out data such as Preset Performance, Arpeggio, and Audition Phrase. You cannot overwrite the data in Preset Memory.

Edit buffer

The edit buffer is the memory location for edited data of these types: Performance, Live Set, and Song. Although the edit buffer is designed specifically for data writing and data reading, the data contained in the edit buffer is lost when the power is turned off. You should always store edited data to User memory before editing new performance or before turning off the power. Data other than Performance and Motion Sequence are automatically stored.

User memory

User data edited in the Edit buffer and utility settings for the entire system are stored in the dedicated area in the User memory. Up to eight Library files (.X8L) read from the USB flash drive are loaded in the dedicated area in the User memory. This is read-write memory and the data will be kept even after the power is turned off.

Basic Structure

Functional blocks
Tone Generator block
A/D Input block
Sequencer block
Arpeggio block
Motion Sequencer block
Effect block
Envelope Follower block
Controller block
▶ Internal Memory

Reference

Display (touch panel) config.
Performance Play (Home)
Motion Control
Mixing
Scene
Play/Rec
Normal Part (AWM) Edit
Drum Part Edit
Normal Part (FM-X) Edit
Common/Audio Edit
Category Search
Utility
Live Set
iPhone/iPad connection

Recall buffer and Compare buffer

If you've selected another Performance without storing the one you were editing, you can recall your original edits, since the edit buffer's contents are stored on backup memory, called the Recall buffer. Also, the instrument has a Compare buffer in which the sound settings prior to editing will temporarily be reinstated for comparison purposes. You can switch between the just-edited sound and its unedited condition, and hear how your edits affect the sound. Both of these are read-write memory types. However, you should make sure to store the sequence data before turning off the power, because any sequence data you've created will be lost when the power is turned off. For instructions on using the Compare function, see the Owner's Manual.

Basic Structure

Functional blocks
Tone Generator block
A/D Input block
Sequencer block
Arpeggio block
Motion Sequencer block
Effect block
Envelope Follower block
Controller block
▶ Internal Memory

Reference

Display (touch panel) config.
Performance Play (Home)
Motion Control
Mixing
Scene
Play/Rec
Normal Part (AWM) Edit
Drum Part Edit
Normal Part (FM-X) Edit
Common/Audio Edit
Category Search
Utility
Live Set
iPhone/iPad connection

Reference

Display (touch panel)

Display (touch panel) configuration

This section explains the navigation bar which is common to all types of displays.

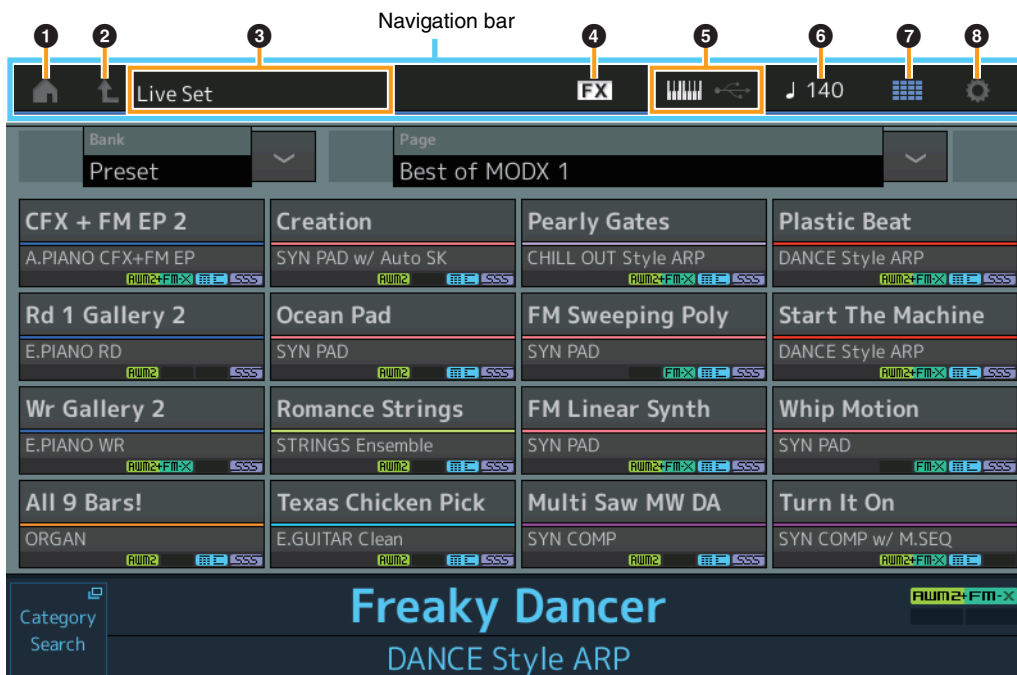

1 HOME icon

Moves to the Performance Play display ([page 27](#)).

2 EXIT icon

Functions same as the [EXIT] button on the panel. Press this icon to exit from the current display and return to the previous level in the hierarchy.

3 [INFORMATION] area

Displays helpful information, including the currently selected display name.

4 EFFECT icon

Touch the icon to call up the Effect Switch display ([page 209](#)). The icon turns off when any of the Effect blocks (Insertion, System or Master) is off.

5 QUICK SETUP icon

Displays the settings of Local Control ON/OFF and MIDI IN/OUT.

The keyboard-shaped icon lights up when Local Control is set to ON and turns off when Local Control is set to OFF.

When MIDI is set as the MIDI IN/OUT setting, a MIDI connector-shaped icon appears. When USB is set as the MIDI IN/OUT setting, a USB connector-shaped icon appears. Touch the desired icon to call up the corresponding Quick Setup display ([page 188](#)).

6 TEMPO SETTINGS icon

Displays the tempo of the currently selected Performance. Touch the icon to call up the Tempo Settings display ([page 207](#)).

7 LIVE SET icon

Touch the icon to call up the Live Set display ([page 212](#)).

8 UTILITY icon

Touch the icon to call up the last opened display among the Utility displays.

Display (touch panel)

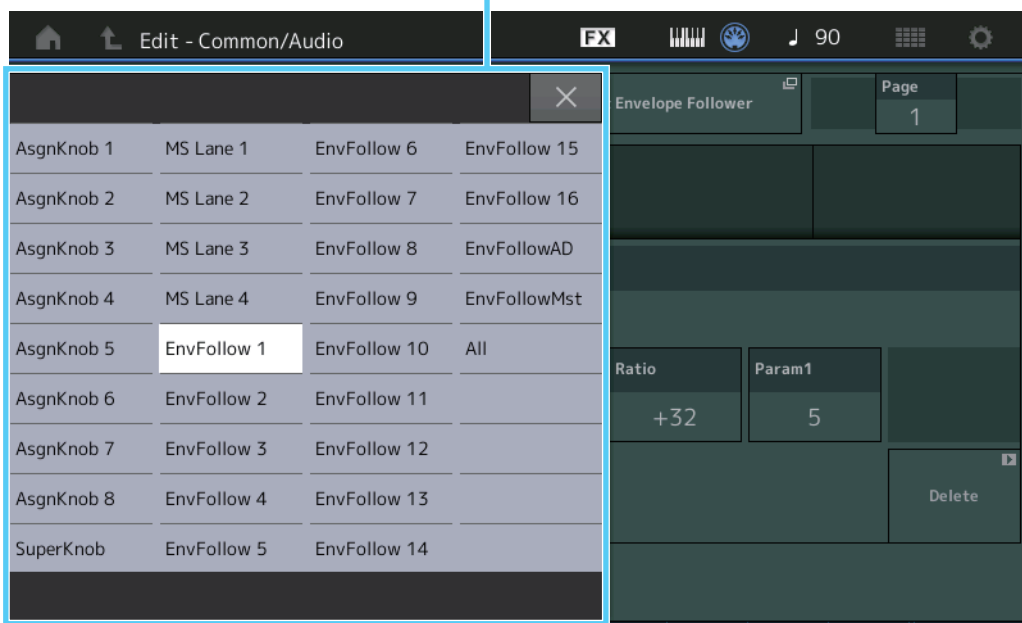
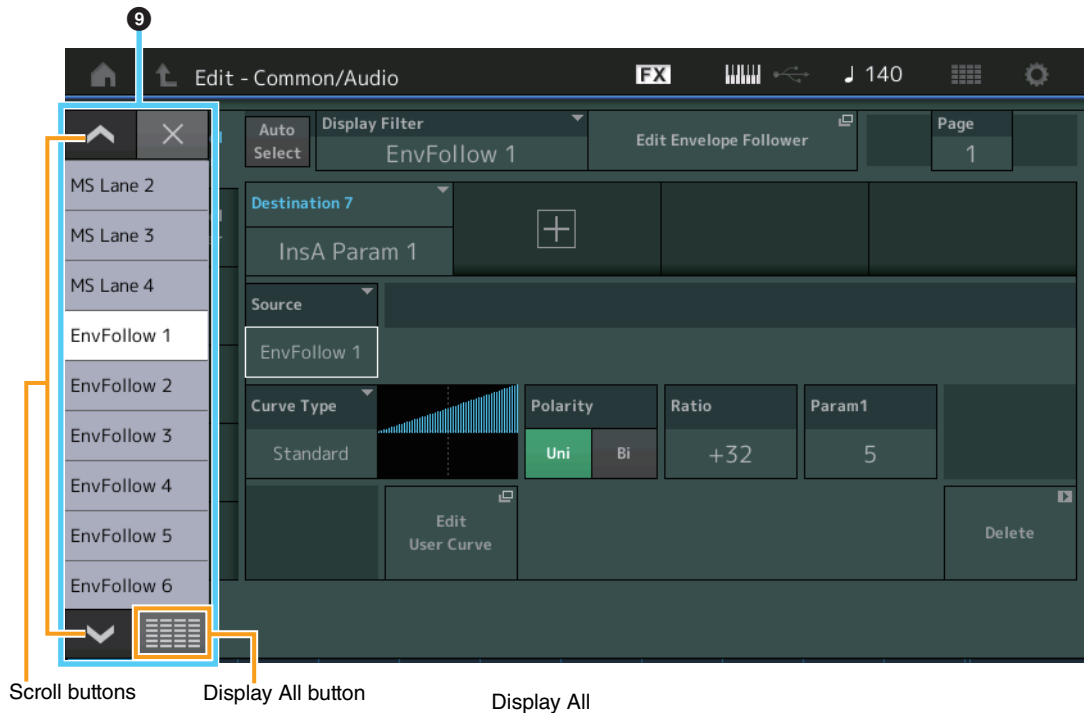
**9 Pop-up List**

Displays setting values for parameters. When the setting values are displayed in multiple pages, you will need to use the Scroll buttons to scroll through the pages or the Display All button to display all of the setting values.

Performance Play (Home)

From the Performance Play display you can play a selected Performance and edit some of the Performance-related settings.

Home

Operation

Press the [PERFORMANCE (HOME)] button
or
Touch the [HOME] icon

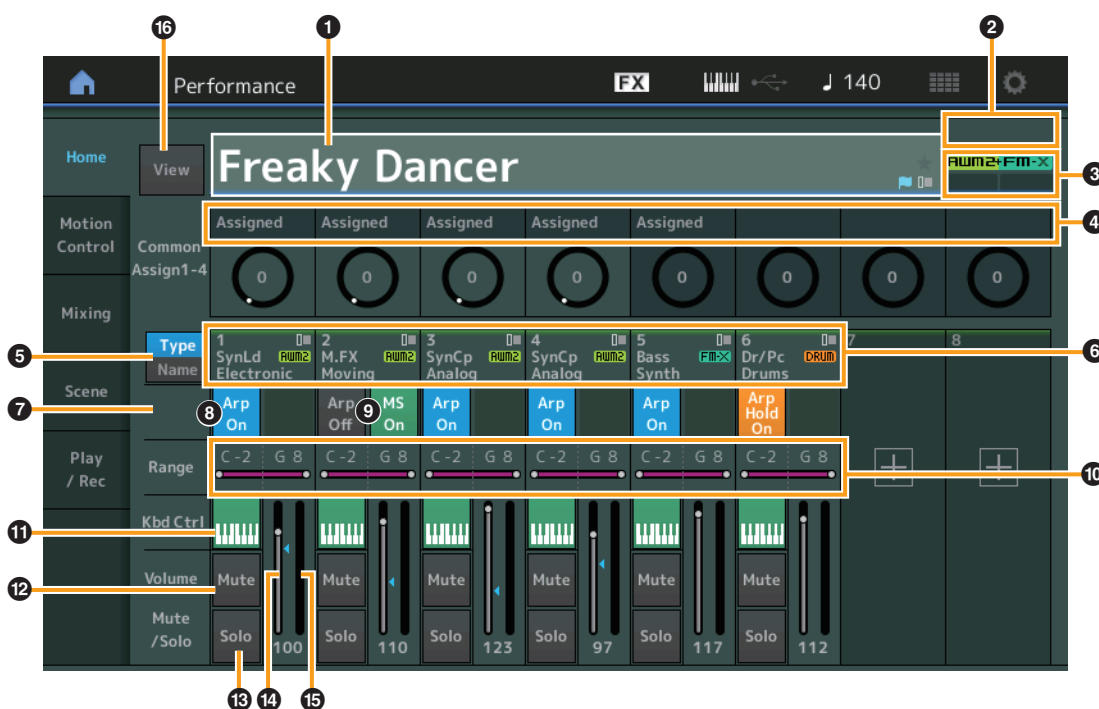

1 Performance name

Indicates the currently selected Performance name. Touching the parameter calls up the menu for Category Search, Edit, and Recall.

NOTE Once you edit any parameter in the selected Performance, a blue flag icon appears at right in the Performance Name.

2 Part indicator

When the cursor is on the Performance name or on Parts 1–8, this indicates whether Parts 9–16 are used or not.

When the cursor is on Parts 9–16, it indicates whether Parts 1–8 are used or not. If Parts 9–16 are not in use, this indicator is not shown.

3 Flag

Indicates the tone generation attributes of the currently selected Performance. (See chart below.)

Flag	Definition
AWM2	Performance comprised only of AWM2 Parts
FM-X	Performance comprised only of FM-X Parts
AWM2+FM-X	Performance comprised of both AWM2 and FM-X Parts
MC	Performance featuring Motion Control
SSS	Performance featuring Seamless Sound Switching

4 Knob functions

Indicates the functions currently assigned to the Knobs 1–4 (5–8).

Performance

Home

Motion Control

Overview

Quick Edit

Arpeggio

Motion Seq

Super Knob

Knob Auto

Mixing

Scene

Play / Rec

MIDI

Audio

5 Type/Name Switch

Switches between the displays of Part Type/Category and Part Name.

Settings: Type, Name

6 Part Types / Part Names

Indicates the Part types and categories or the Part names.

Touching the parameter calls up the menu for Category Search, Edit, and Copy.

To add another Part, touch the “+” icon.

7 Common Motion Sequencer switch

Determines whether the Motion Sequencer of the Common/AD Parts is on or off. When all Lane switches of the Common/AD Parts are off, this switch is not shown.

Settings: Off, On

8 Part Arpeggio On/Off switch

Determines whether the Arpeggio of each Part is on or off. When the Arpeggio and the Arpeggio Hold are set to on, “Arp Hold On” is displayed.

NOTE You can turn the Arpeggio Hold for the Part on or off by simultaneously holding down the [SHIFT] button and touching this switch.

Settings: Off, On

9 Part Motion Sequencer switch

Determines whether the Motion Sequencer of each Part is on or off. When all Lane switches of the Part are off, this switch is not shown.

Settings: Off, On

10 Note Limit

Determines the lowest and highest notes in the Part’s note range. For example, setting a Note Limit of “C5–C4” lets you hear the Part by playing notes in the two ranges of C-2 to C4 and C5 to G8; notes played between C4 and C5 have no sound. For details about the Note Limit setting, see the Owner’s Manual.

Settings: C -2 – G8

11 Keyboard Control switch

Determines whether the Keyboard Control for each Part is on or off. When this switch is set to off, the Part will not sound even you play the keyboard (unless the Part is selected).

Settings: Off, On

12 Switching Mute on/off for Parts

Determines whether the Mute for each Part is on or off.

Settings: Off, On

13 Switching Solo on/off for Parts

Determines whether the Solo for each Part is on or off.

Settings: Off, On

14 Volume of Parts

Determines the Volume for the Part.

Settings: 0–127

NOTE When the triangle marks for the Volume are shown in blue, the volume change created by the control sliders is not reflected to the overall sound. When the value changed by the control slider reaches the value shown as a blue triangle, the triangle mark changes to white, and the volume change created by the control sliders are reflected to the overall sound.

15 Meter

Indicates the audio output level of the Part.

Performance

▶ Home

Motion Control

Overview

Quick Edit

Arpeggio

Motion Seq

Super Knob

Knob Auto

Mixing

Scene

Play / Rec

MIDI

Audio

16 View

Determines whether the detailed information of each Part is displayed (On) or not displayed (Off). The displayed information differs depending on the cursor position or the Control function settings.

Settings: Off, On

NOTE When the cursor is on the Performance name on the Performance Play (Home) display, you can also switch the information views by pressing the [PERFORMANCE (HOME)] button.

This section explains when “View” is turned on.

■ Element view

This appears only when the currently selected Part is the Normal Part (AWM2), and Motion Control → Overview → Slider Function [Elem/Op Control] button is ON.

The screenshot shows the Performance screen for 'Freaky Dancer'. The 'View' button is active. The 'Part' section shows four parts (1-4, 5-8, 9-12, 13-16) with their respective element switches and levels. The 'Element SW / Level' section shows eight element switches (1-8) and their corresponding levels (110, 98, 98, 63, 127, 100, 127, 113). The 'Element Level' and 'Element Switch' labels are positioned below the respective sections.

Element SW (Element switch)

Determines whether each Element is active or not.

Settings: Off, On

Element Level

Determines the output level of the Element.

Settings: 0–127

Performance

▶ Home

Motion Control

Overview

Quick Edit

Arpeggio

Motion Seq

Super Knob

Knob Auto

Mixing

Scene

Play / Rec

MIDI

Audio

■ Drum Key view

This appears only when the currently selected Part is the Drum Part, and Motion Control → Overview → Slider Function [Elem/Op Control] button is ON.



Drum Key Level

Drum Key Level

Determines the output level of the Drum Key.

Settings: 0-127

Performance

▶ Home

Motion Control

- Overview
- Quick Edit
- Arpeggio
- Motion Seq
- Super Knob
- Knob Auto

Mixing

Scene

Play / Rec

MIDI

Audio

■ Algorithm view

This appears only when the currently selected Part is the Normal Part (FM-X), and Motion Control → Overview → Slider Function [Elem/Op Control] button is ON.



Algorithm (Algorithm Number)

Changes Algorithms.

Settings: See the Data List PDF document.

NOTE Tapping the Algorithm image calls up the Algorithm Search display.

Feedback (Feedback Level)

Waveforms can be changed by feeding some of the signal generated by an operator back through that operator. This allows you to set the feedback level.

Settings: 0-7

Operator Level

Determines the output level of the Operator.

Settings: 0-99

Performance

▶ Home

Motion Control

Overview

Quick Edit

Arpeggio

Motion Seq

Super Knob

Knob Auto

Mixing

Scene

Play / Rec

MIDI

Audio

■ Part – Note view

This appears only when the [PART CONTROL] button is turned on or the cursor is on the Note Limit. This is useful for checking the Layer/Split settings among Parts.

The screenshot displays the Performance screen for 'Freaky Dancer' in 'Part - Note' view. The interface is divided into several sections: Motion Control, Mixing, Scene, Play / Rec, and Kbd Ctrl. The 'Part' section shows four parts (1-4, 5-8, 9-12, 13-16) with their respective settings. The 'Range' section is highlighted with an orange box, showing a 'Note Limit' indicator. The 'Part - Note' piano roll on the right shows the notes for each part.

Note Limit

■ Velocity – Note view

This appears only when the cursor is on any velocity limit of Parts. This is useful for setting Velocity split among Parts.

The screenshot displays the Performance screen for 'Freaky Dancer' in 'Velocity - Note' view. The interface is divided into several sections: Motion Control, Mixing, Scene, Play / Rec, and Kbd Ctrl. The 'Part' section shows four parts (1-4, 5-8, 9-12, 13-16) with their respective settings. The 'Range' section is highlighted with an orange box, showing a 'Velocity Limit' indicator. The 'Velocity - Note' piano roll on the right shows the velocity for each part.

Velocity Limit

Performance

▶ Home

Motion Control

Overview

Quick Edit

Arpeggio

Motion Seq

Super Knob

Knob Auto

Mixing

Scene

Play / Rec

MIDI

Audio

Motion Control

From the Motion Control display you can edit all Motion Control settings, such as general sound settings, Arpeggio, and the Motion Sequencer of the currently selected Performance.

The Motion Control section contains the following various displays.

- Overview
- Quick Edit
- Arpeggio
- Motion Sequencer
- Super Knob
- Knob Auto

Motion Control

Overview

The Overview display indicates the illustration of the connection between Controllers and Parts. You can confirm the current settings here.

NOTE Lines between the most recently used controller and Part are shown in bold.

Operation

[PERFORMANCE (HOME)] → [Motion Control] → [Overview]
or
[SHIFT] + [PERFORMANCE (HOME)]

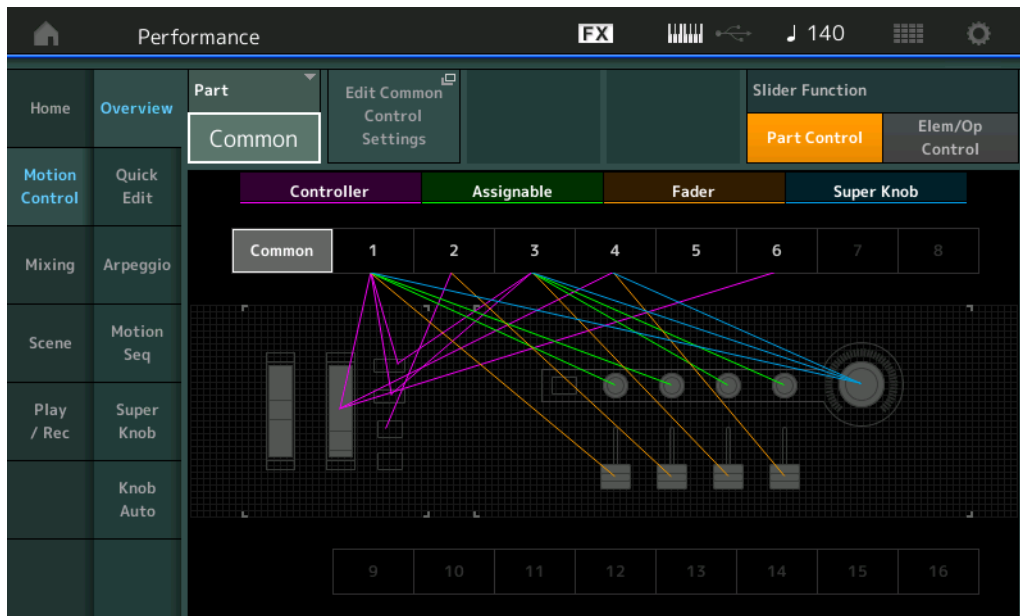

Part

Indicates the currently selected Part. To confirm a Part's connections, select the Part here.

Settings: Common, Part 1–16

Edit Common Control Settings/Edit Part Control Settings

Calls up the Control Assign display for the selected Part. For “Common,” see [page 166](#). For Part 1–16, see [page 100](#).

Slider Function

Switches among Performance Control, Part Control, and Element/Operator Control.

Settings: Part Control, Elem/Op Control

NOTE You can store Slider function operations as Performance data.

Performance

Home

Motion Control

Overview

Quick Edit

Arpeggio

Motion Seq

Super Knob

Knob Auto

Mixing

Scene

Play / Rec

MIDI

Audio

Controller

Determines whether or not the illustration of the connection between “Controller” and Part is shown. The “Controller” here refers to:

- Pitch Bend wheel
- Modulation wheel
- [ASSIGN 1] and [ASSIGN 2] buttons (Assignable switches 1 and 2)
- [MOTION SEQ HOLD] (Motion sequencer Hold) button
- [MOTION SEQ TRIGGER] (Motion sequencer trigger) button

Settings: Off, On

Assignable

Determines whether or not the illustration of the connection between “Assignable” and Part is shown. The “Assignable” here refers to:

- Assignable Knobs 1–4 (5–8)

Settings: Off, On

Fader

Determines whether or not the illustration of the connection between “Fader” and Part is shown. The “Fader” here refers to:

- Control sliders 1–4 (5–8 / 9–12 / 13–16)

Settings: Off, On

Super Knob

Determines whether or not the illustration of the connection between “Super Knob” and Part is shown. The “Super Knob” here refers to:

- Super Knob

Settings: Off, On

Performance

Home

Motion Control

▶ Overview

Quick Edit

Arpeggio

Motion Seq

Super Knob

Knob Auto

Mixing

Scene

Play / Rec

MIDI

Audio

Quick Edit

From the Quick Edit display you can make general sound settings. You can select whether the settings are commonly applied to all Parts or to only one selected Part.

Operation [PERFORMANCE (HOME)] → [Motion Control] → [Quick Edit]



Performance

Home

Motion Control

Overview

▶ Quick Edit

Arpeggio

Motion Seq

Super Knob

Knob Auto

Mixing

Scene

Play / Rec

MIDI

Audio

Part

Indicates the currently selected Part. Select the Part you want to use Quick Edit with here.

Settings: Common, Part 1–16

■ When “Part” is set to “Common”

You can edit the parameters commonly applied to all Parts.

Performance Name

Enters the desired name for the Performance. Performance names can contain up to 20 characters. Touching the parameter calls up the input character display.

FEG Atk (FEG Attack Time)

Determines the speed of filter variation from the time a note is played until the maximum initial level of the Cutoff Frequency is reached. This parameter determines the offset value of the FEG ([page 118](#)) for the Element/Operator Common.

Settings: -64 – +63

FEG Decay (FEG Decay Time)

Determines how fast the Cutoff Frequency falls from maximum attack level to the sustain level. This parameter determines the offset value of the FEG parameter ([page 118](#)) for the Element/Operator Common.

Settings: -64 – +63

FEG Rel (FEG Release Time)

Determines how fast the Cutoff Frequency falls from the sustain level to zero when a note is released. This parameter determines the offset value for the FEG parameter ([page 118](#)) of the Element/Operator Common.

Settings: -64 – +63

Edit Master EQ

Calls up the Master EQ display ([page 173](#)) for Common/Audio Edit.

Edit All Arp (Edit All Arpeggio)

Calls up the Arpeggio display ([page 41](#)) for Motion Control.

Edit Common MS (Edit Common Motion Sequencer)

Calls up the Motion Sequencer Lane display ([page 165](#)) for Common/Audio Edit.

Cutoff (Cutoff Frequency)

Determines the Cutoff Frequency for the Filter, when the Low Pass Filter is selected, for example, the larger the value the brighter the decay. This parameter determines the offset value of the Filter Cutoff Frequency ([page 115](#)) for the Element/Drum Key/Operator Common.

Settings: -64 – +63

Resonance

Determines the emphasis given to the Cutoff Frequency. This parameter determines the offset value of the Filter Resonance ([page 116](#)) for the Element/Drum Key/Operator Common.

Settings: -64 – +63

FEG Depth

Determines the range over which the cutoff frequency of the Filter EG changes. This parameter determines the offset value of the FEG Depth ([page 118](#)) for the Element/Operator Common.

Settings: -64 – +63

Portamento (Portamento Time)

Determines the pitch transition time when Portamento is applied. This parameter is synchronized to the same parameter for the Common/Audio Edit.

Settings: -64 – +63

Attack (AEG Attack Time)

Determines the speed of attack from the time a key is played until the maximum initial level of the AEG is reached. This parameter determines the offset value of the AEG ([page 123](#), [page 143](#), [page 157](#)) for the Element/Drum Key/Operator.

Settings: -64 – +63

Decay (AEG Decay Time)

Determines how fast the volume falls from maximum attack level to the sustain level. This parameter determines the offset value of the AEG ([page 123](#), [page 143](#), [page 157](#)). for the Element/Drum Key/Operator

Settings: -64 – +63

Sustain (AEG Sustain Level)

Determines the sustain level at which the volume will continue while a note is held, after the initial attack and decay. This parameter determines the offset value of the AEG ([page 123](#), [page 143](#), [page 157](#)) for the Element/Drum Key/Operator.

Settings: -64 – +63

Release (AEG Release Time)

Determines how fast the volume falls from the sustain level to zero when a note is released. This parameter determines the offset value of the AEG ([page 123](#), [page 143](#), [page 157](#)) for the Element/Drum Key/Operator.

Settings: -64 – +63

Low Gain (Maser EQ Low Gain)

Determines the level gain of the Master EQ Low band.

Settings: -12dB – +12dB

Lo Mid Gain (Master EQ Low Mid Gain)

Determines the level gain of the Master EQ Low Mid band.

Settings: -12dB – +12dB

Mid Gain (Master EQ Mid Gain)

Determines the level gain of the Master EQ Mid band.

Settings: -12dB – +12dB

Performance

Home

Motion Control

Overview

▶ Quick Edit

Arpeggio

Motion Seq

Super Knob

Knob Auto

Mixing

Scene

Play / Rec

MIDI

Audio

Hi Mid Gain (Master EQ High Mid Gain)

Determines the level gain of the Master EQ High Mid band.

Settings: -12dB – +12dB

High Gain (Master EQ High Gain)

Determines the level gain of the Master EQ High band.

Settings: -12dB – +12dB

Pan (Performance Pan)

Determines the stereo pan position of the selected Performance. This parameter offsets the same parameter in the Part Edit setting.

Settings: L63–C (center)–R63

Var Return (Variation Return)

Determines the Return level of the Variation Effect.

Settings: 0–127

Rev Return (Reverb Return)

Determines the Return level of the Reverb Effect.

Settings: 0–127

Common Clock Swing (Common Swing)

Determines the Swing of the Arpeggio/Motion Sequencer for the entire Performance. This is the offset value for the Swing of the Arpeggio/Motion Sequencer for each Part.

Settings: -120 – +120

Common Clock Unit (Common Unit Multiply)

Adjusts the Arpeggio/Motion Sequencer playback time for the entire Performance.

This parameter is applied to the Part when the Unit Multiply parameter for Arpeggio/Motion Sequencer of the Part is set to “Common.”

By using this parameter, you can create a different Arpeggio/Motion Sequencer type from the original one.

Settings: 50%–400%

200%: The playback time will be doubled and the tempo is halved.

100%: The normal playback time.

50%: The playback time will be halved and the tempo doubled.

Common Arp Gate Time (Common Arpeggio Gate Time)

Determines the Gate Time Rate (length) of the Arpeggio for the entire Performance. This is the offset value for the Gate Time Rate of the Arpeggio for each Part.

Settings: -100 – +100

Common Arp Velocity (Common Arpeggio Velocity Rate)

Determines the Velocity Rate of the Arpeggio for the entire Performance. This is the offset value for the Velocity Rate of the Arpeggio for each Part.

Settings: -100 – +100

Common Motion Seq Amplitude (Common Motion Sequencer Amplitude)

Determines the Amplitude of the Motion Sequencer for the entire Performance. “Amplitude” determines how the entire Motion Sequence changes.

This is the offset value for the Part Motion Seq Amplitude, which is also the offset value for the Lane Amplitude. This results in that both of the Common and Part MS Amplitudes offset the Amplitude setting in the Lane (only when “MS FX” is set to on for the Lane).

Settings: -64 – +63

Common Motion Seq Shape (Common Motion Sequencer Pulse Shape)

Determines the Pulse Shape of the Motion Sequencer for the entire Performance. This changes the step curve shape of the sequence.

This is the offset value for the Part Motion Seq Pulse Shape, which is also the offset value for the Lane Pulse Shape. This results in that both of the Common and Part MS Pulse Shapes offset the Pulse Shape setting for the parameter in the Lane (only when “MS FX” is set to on for the Lane and “Control” is set to on for the parameter).

Settings: -100 – +100

Performance

Home

Motion Control

Overview

▶ Quick Edit

Arpeggio

Motion Seq

Super Knob

Knob Auto

Mixing

Scene

Play / Rec

MIDI

Audio

Common Motion Seq Smooth (Common Motion Sequencer Smoothness)

Determines the Smoothness of the Motion Sequencer for the entire Performance. “Smoothness” is the degree to which the time of the Motion Sequence is smoothly changed.

This is the offset value for the Part Motion Seq Smoothness, which is also the offset value for the Lane Smoothness. This results in that both of the Common and Part MS Smoothnesses offset the Smoothness setting for the parameter in the Lane (only when “MS FX” is set to on for the Lane).

Settings: -64 – +63

Common Motion Seq Random (Common Motion Sequencer Random)

Determines the Random of the Motion Sequencer for the entire Performance. “Random” is the degree to which the Step Value of the Sequence is randomly changed.

This is the offset value for the Part Motion Seq Random when “MS FX” is set to on for the Lane.

Settings: -64 – +63

■ When “Part” is set to Part 1–16

You can edit the parameters for the selected Part.



Part Category Main (Part Main Category)

Part Category Sub (Part Sub Category)

Determines the Main Category and Sub Category of the Part.

The categories are keywords representing the general characteristics of the Parts. Selecting the appropriate category makes it easy to find the desired Part from the huge variety of Parts available.

There are 17 Main Categories which indicate types of instruments. There are up to nine Sub Categories for each Main Category, indicating more detailed types of instruments.

Settings: See the Data List PDF document.

Performance

Home

Motion Control

Overview

Quick Edit

Arpeggio

Motion Seq

Super Knob

Knob Auto

Mixing

Scene

Play / Rec

MIDI

Audio

Part Name

Enters the desired name for the Part. Part names can contain up to 20 characters. Touching the parameter calls up the input character display.

The parameters below are same as the ones when “Part” is set to “Common” ([page 35](#)).

- FEG Atk (FEG Attack Time)
- FEG Decay (FEG Decay Time)
- FEG Rel (FEG Release Time)
- Cutoff
- Resonance
- FEG Depth

- Portamento (Portamento Time)

The setting values differ from the ones which “Part” is set to “Common.”

Settings: 0–127

- Attack (AEG Attack Time)
- Decay (AEG Decay Time)
- Sustain (AEG Sustain Level)
- Release (AEG Release Time)

FEG Sus (FEG Sustain Level)

Determines the FEG Sustain Level for the Part. This is the offset value for the FEG Decay2 Level of the Element/Operator Common ([page 118](#)).

Settings: -64 – +63

Edit Part EQ

Calls up the Part EQ display ([page 78](#)) for Part Edit.

Edit Part Arp (Edit Part Arpeggio)

Calls up the Arpeggio display ([page 82](#)) for Part Edit.

Edit Part MS (Edit Part Motion Sequencer)

Calls up the Motion Sequencer Lane display ([page 91](#)) for Part Edit.

EQ Low Gain (3 band EQ Low Gain)

Determines the level gain for the Low band.

Settings: -12dB – +12dB

EQ Mid Freq (3 band EQ Mid Frequency)

Determines the frequency for the Mid band.

Settings: 139.7Hz–10.1kHz

EQ Mid Gain (3 band EQ Mid Gain)

Determines the level gain for the Mid band.

Settings: -12dB – +12dB

EQ Mid Q (3 band EQ Mid Q)

Determines the EQ bandwidth of the Mid band.

Settings: 0.7–10.3

EQ High Gain (3 band EQ Hi Gain)

Determines the level gain of the High band.

Settings: -12dB – +12dB

Pan

Determines the stereo pan position of the selected Part.

Settings: L63–C (center)–R63

Var Send (Variation Send)

Determines the Send level of the signal sent to the Variation effect.

Settings: 0–127

Performance

Home

Motion Control

Overview

▶ Quick Edit

Arpeggio

Motion Seq

Super Knob

Knob Auto

Mixing

Scene

Play / Rec

MIDI

Audio

Rev Send (Reverb Send)

Determines the Send level of the signal sent to the Reverb effect.

Settings: 0–127

Part Clock Swing (Part Swing)

Delays notes on even-numbered beats (backbeats) to produce a swing feel.

- +1 and higher: Delay the Arpeggio notes.
- -1 and lower: Advance the Arpeggio notes.
- 0: Exact timing as set by “Arpeggio/Motion Sequencer Grid” Value, resulting in no swing.

Judicious use of this setting lets you create swing rhythms and triplet feels, such as shuffle and bounce.

Settings: -120 – +120

Part Clock Unit (Part Unit Multiply)

Adjusts the Arpeggio/Motion Sequencer playback time for the selected Part.

Settings: 50%–400%, Common

200%: The playback time will be doubled and the tempo is halved.

100%: The normal playback time.

50%: The playback time will be halved and the tempo doubled.

Common: The value set in the Unit Multiply common to the all Parts will be applied.

Part Arp Gate Time (Part Arpeggio Gate Time)

Determines how much the Gate Time (length) of the Arpeggio notes is offset from the original value. This is the offset value for the Gate Time Rate ([page 86](#)) of each Arpeggio Select setting.

Settings: 0%–200%

Part Arp Velocity (Part Arpeggio Velocity Rate)

Determines how much the velocity of Arpeggio playback is offset from the original value. This is the offset value for the Velocity Rate ([page 85](#)) of each Arpeggio Select setting.

Settings: 0%–200%

Part Motion Seq Amplitude (Part Motion Sequencer Amplitude)

Determines the Amplitude ([page 93](#)) of the Motion Sequencer for the selected Part.

This is the offset value for the Lane Motion Seq Amplitude when “MS FX” is set to on for the Lane.

Settings: -64 – +63

Part Motion Seq Shape (Part Motion Sequencer Pulse Shape)

Determines the Pulse Shape of the Motion Sequencer for the selected Part.

This is the offset value for the Lane Motion Seq “Step Curve Parameter” ([page 94](#)) when “MS FX” is set to on for the Lane and “Control” is set to on for the parameter.

Settings: -100 – +100

Part Motion Seq Smooth (Part Motion Sequencer Smoothness)

Determines the Smoothness of the Motion Sequencer for the selected Part.

This is the offset value for the Lane Motion Seq Smoothness ([page 93](#)) when “MS FX” is set to on for the Lane.

Settings: -64 – +63

Part Motion Seq Random

Determines the Random of the Motion Sequencer for the selected Part. “Random” is the degree to which the Step Value of the Sequence is randomly changed.

Settings: 0–127

Performance

Home

Motion Control

Overview

▶ Quick Edit

Arpeggio

Motion Seq

Super Knob

Knob Auto

Mixing

Scene

Play / Rec

MIDI

Audio

Arpeggio

From the Arpeggio display you can set Arpeggio-related parameters for multiple Parts. Touching the Arpeggio Type name on this display (or pressing the [CATEGORY] button on the panel) calls up a menu. In the displayed menu, touch [Search] to call up the Arpeggio Category Search display and touch [Number] to determine the Arpeggio Type by specifying the Arpeggio Number.

Operation [PERFORMANCE (HOME)] → [Motion Control] → [Arpeggio]

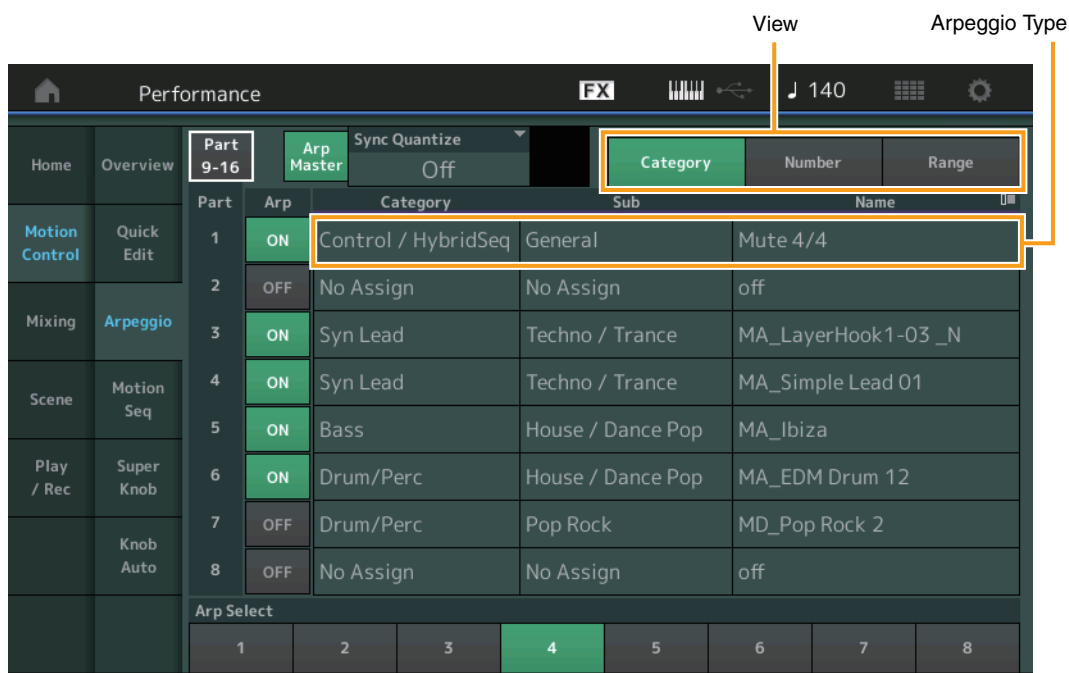

Part 9-16 / Part 1-8

Switches between the displays of Parts 9–16 or the Parts 1–8. In case of the picture above, touch the “Part 9-16” to display the Arpeggio Types for the “Part 9-16.”

Settings: Part 9-16 / Part 1-8

Arp Master (Arpeggio Master Switch)

Determines whether the Arpeggio is on or off for the entire Performance. This setting is applied to the [ARP ON/OFF] button on the panel.

Settings: Off, On

Sync Quantize (Sync Quantize Value)

Determines the actual timing at which the next Arpeggio playback starts when you trigger it while the Arpeggio of multiple Parts is playing back. When set to “off,” the next Arpeggio starts as soon as you trigger it. The number indicates the clock.

Settings: Off, 60 (32nd note), 80 (16th note triplet), 120 (16th note), 160 (8th note triplet), 240 (8th note), 320 (1/4 note triplet), 480 (1/4 note)

Arp (Part Arpeggio Switch)

Determines whether the Arpeggio for each Part is on or off.

Settings: Off, On

Arp Select (Arpeggio Select)

Determines the Arpeggio Types.

By selecting a type and pressing [SHIFT] + [EDIT], you can copy or exchange Arpeggios. For details, see “Copying or Exchanging Arpeggios” (page 86).

Settings: 1–8

Performance

Home

Motion Control

Overview

Quick Edit

▶ Arpeggio

Motion Seq

Super Knob

Knob Auto

Mixing

Scene

Play / Rec

MIDI

Audio

View

Determines which information regarding Arpeggio Type is displayed.

Settings: Category, Number, Range

■ When “View” is set to “Category”

Category (Arpeggio Category)

Settings: See the Arpeggio category list ([page 11](#)).

Sub (Arpeggio Sub Category)

Settings: See the Arpeggio sub category list ([page 11](#)).

Name (Arpeggio Name)

Settings: See the Data List PDF document.

■ When “View” is set to “Number”

Home		Overview		Part	Arp Master	Sync Quantize	Category		Number	Range
				9-16	<input checked="" type="checkbox"/>	Off				
Part	Arp	Bank		Number	Name					
1	<input checked="" type="checkbox"/>	Preset		10221	Mute 4/4					
2	<input type="checkbox"/>	Preset		0	off					
3	<input checked="" type="checkbox"/>	Preset		4999	MA_LayerHook1-03_N					
4	<input checked="" type="checkbox"/>	Preset		5016	MA_Simple Lead 01					
5	<input checked="" type="checkbox"/>	Preset		3673	MA_Ibiza					
6	<input checked="" type="checkbox"/>	Preset		8321	MA_EDM Drum 12					
7	<input type="checkbox"/>	Preset		6576	MD_Pop Rock 2					
8	<input type="checkbox"/>	Preset		0	off					
Arp Select										
		1	2	3	<input checked="" type="checkbox"/> 4	5	6	7	8	

Bank (Arpeggio Bank)

Settings: Preset, User, Library 1–8

Number (Arpeggio Number)

Settings: See the Data List PDF document.

Name (Arpeggio Name)

Settings: See the Data List PDF document.

Performance

Home

Motion Control

Overview

Quick Edit

▶ Arpeggio

Motion Seq

Super Knob

Knob Auto

Mixing

Scene

Play / Rec

MIDI

Audio

■ When “View” is set to “Range”

Part	Arp	Name	Velocity Limit	Note Limit
1	ON	Mute 4/4	1 127	C -2 G 8
2	OFF	off	1 127	C -2 G 8
3	ON	MA_LayerHook1-03_N	1 127	C -2 G 8
4	ON	MA_Simple Lead 01	1 127	C -2 G 8
5	ON	MA_Ibiza	1 127	C -2 G 8
6	ON	MA_EDM Drum 12	1 127	C -2 G 8
7	OFF	MD_Pop Rock 2	1 127	C -2 G 8
8	OFF	off	1 127	C -2 G 8

Arp Select: 1 2 3 **4** 5 6 7 8

Performance

Home

Motion Control

Overview

Quick Edit

▶ Arpeggio

Motion Seq

Super Knob

Knob Auto

Mixing

Scene

Play / Rec

MIDI

Audio

Name (Arpeggio Name)

Settings: See the Data List PDF document.

Velocity Limit (Arpeggio Velocity Limit)

Determines the lowest and highest velocity which can trigger Arpeggio playback. For details on settings of Velocity Limit, see the Owner's Manual.

Settings: 1–127

Note Limit (Arpeggio Note Limit)

Determines the lowest and highest notes in the Arpeggio's note range. For details on settings of Note Limit, see the Owner's Manual.

Settings: C -2 – G8

Motion Seq (Motion Sequencer)

From the Motion Sequencer display you can set parameters related to Motion Sequencer for multiple Parts.

Operation [PERFORMANCE (HOME)] → [Motion Control] → [Motion Seq]



MS Master (Motion Sequencer Master Switch)

Determines whether the Motion Sequencer is on or off for the entire Performance. This setting is applied to the [MS ON/OFF] button on the panel.

Settings: Off, On

Active (Active Motion Sequencer)

Indicates the number of the active Lane. The number after slash indicates the maximum number of the Lanes which can be activated simultaneously.

PartSW (Motion Sequencer Part Switch)

Determines whether the Motion Sequencer is on or off for each Part/all Parts.

Settings: Off, On

Lane Switch

Determines whether each Lane is on or off. You can set up to four Lanes corresponding to the Motion Sequencer function for one Part. Up to eight Lanes can be used at the same time for the entire Performance.

Settings: Off, On

Motion Seq Select (Motion Sequence Select)

Determines the Motion Sequence Type.

By selecting a type and pressing [SHIFT] + [EDIT], you can copy or exchange Motion Sequences. For details, see “Copying or Exchanging Motion Sequences” (page 95).

Settings: 1–8

Performance

Home

Motion Control

Overview

Quick Edit

Arpeggio

▶ Motion Seq

Super Knob

Knob Auto

Mixing

Scene

Play / Rec

MIDI

Audio

Super Knob

From the Super Knob display you can set parameters controlled by the Super knob.

Operation [PERFORMANCE (HOME)] → [Motion Control] → [Super Knob]

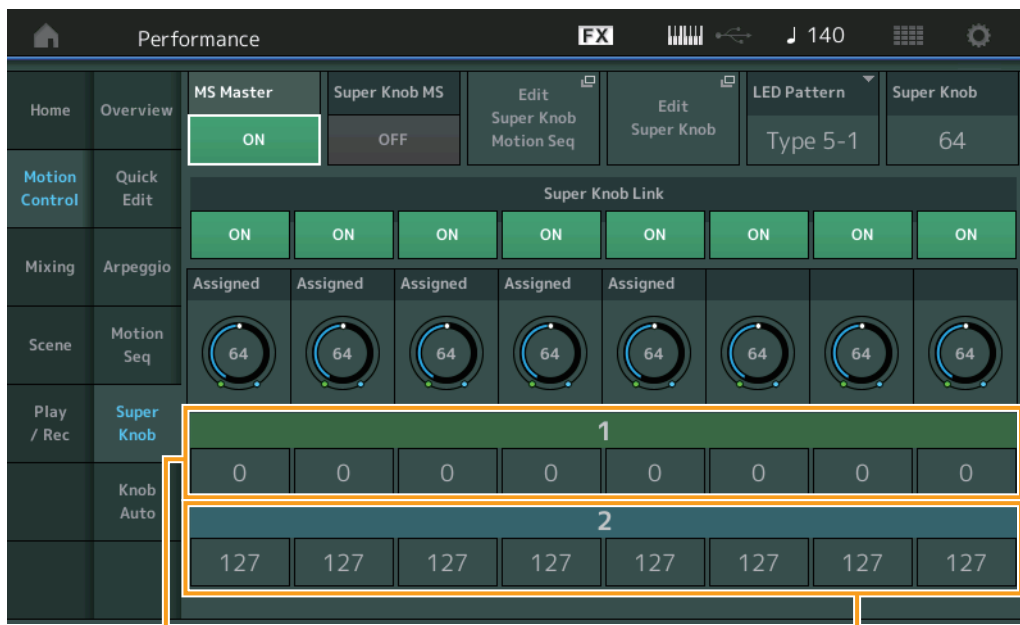

Assignable Knob 1–8 Destination Value 1

Assignable Knob 1–8 Destination Value 2

MS Master (Motion Sequencer Master Switch)

Turns the Motion Sequencer for the entire Performance on/off. This setting is applied to the [MS ON/OFF] button on the panel.

Settings: Off, On

Super Knob MS (Super Knob Motion Sequencer Switch)

Turns the Motion Sequencer applied to the Super Knob on/off.

Settings: Off, On

Edit Super Knob Motion Seq

Shows the Knob Auto display, in which you can set the Motion Sequencer for the Super Knob.

Edit Super Knob

Shows the Control Assign display for Common/Audio Edit, in which you can set the parameters to be controlled by the Super Knob.

LED Pattern (Super Knob LED Pattern)

Determines the lighting pattern of the Super Knob.

Settings: Type 1, Type 2-1, Type 2-2, Type 3-1, Type 3-2, Type 4-1, Type 4-2, Type 5-1, Type 5-2, Type 6, Type 7-1, Type 7-2, Type 8-1, Type 8-2, Type 9, Type 10, Type 11, Off

Super Knob (Super Knob Value)

Determines the value of the Super Knob.

Settings: 0–127

Super Knob Link

Turns the link between the Assignable Knob and the Super Knob on/off. When this is set to off, the function value assigned to the corresponding knob does not change even if the Super Knob is controlled.

Settings: Off, On

Performance

Home

Motion Control

Overview

Quick Edit

Arpeggio

Motion Seq

▶ Super Knob

Knob Auto

Mixing

Scene

Play / Rec

MIDI

Audio

Assignable Knob 1–8 Value

Determines the value for the Assignable Knobs 1–4 (5–8).

Settings: 0–127

Assignable Knob 1–8 Destination Value 1

Assignable Knob 1–8 Destination Value 2

Determines the lowest value (Assignable value 1) and the highest value (Assignable value 2) for the corresponding Knob.

When you operate the Super Knob, the Assignable Knob value varies within the specified range.

Settings: 0–127

Knob Auto

From the Knob Auto display you can set parameters related to Motion Sequencer applied to the Super Knob (Super Knob Motion Sequencer.) The parameter value of the Super Knob can be automatically controlled by the Motion Sequencer.

You can set only one Lane for the Super Knob Motion Sequencer.

NOTE Up to eight Lanes can be used at the same time for the entire Performance. However, the Lane set for the Super Knob is not included in the eight referred to here.

Operation

[PERFORMANCE (HOME)] → [Motion Control] → [Knob Auto]

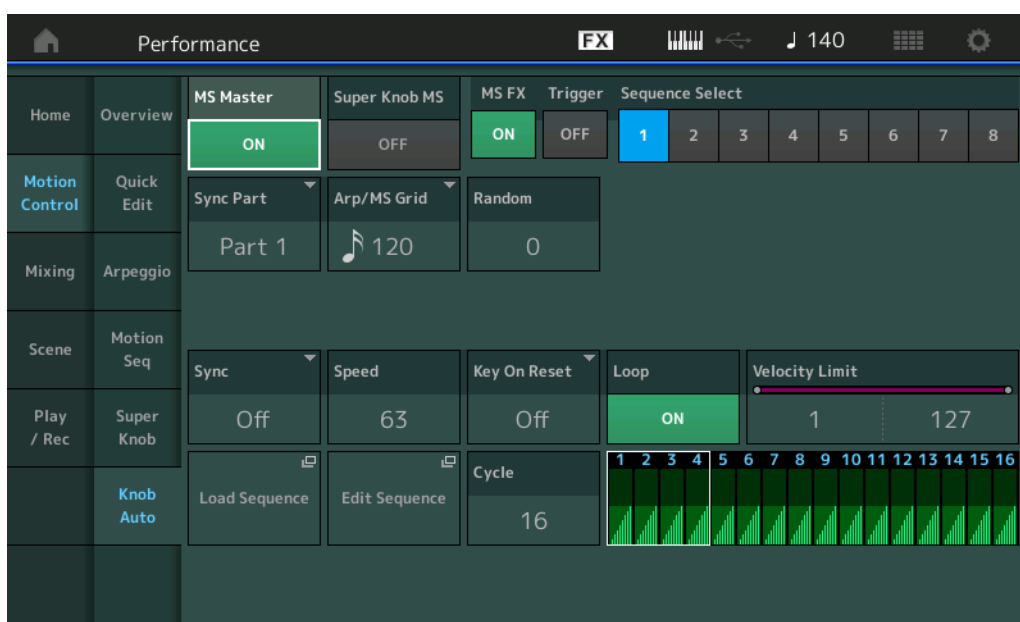

MS Master (Motion Sequencer Master Switch)

Turns the Motion Sequencer for the entire Performance on/off. This setting is applied to the [MS ON/OFF] button on the panel.

Settings: Off, On

Super Knob MS (Super Knob Motion Sequencer Switch)

Turns the Motion Sequencer applied to the Super Knob on/off.

Settings: Off, On

MS FX (Super Knob Motion Sequencer FX Receive)

Determines whether or not the Motion Sequencer is affected by the knob operation when “ARP/MS” is selected with the Knob Function [TONE]/[EG/FX]/[EQ]/[ARP/MS] button.

Settings: Off, On

Performance

Home

Motion Control

Overview

Quick Edit

Arpeggio

Motion Seq

▶ Super Knob

▶ Knob Auto

Mixing

Scene

Play / Rec

MIDI

Audio

Trigger (Super Knob Motion Sequencer Trigger Receive)

Determines whether the signal from the [MOTION SEQ TRIGGER] button is received or not. When this is set to on, the Motion Sequence will begin whenever you press the [MOTION SEQ TRIGGER] button.

Settings: Off, On

Sequence Select (Super Knob Motion Sequence Select)

Determines the Motion Sequence Type.

By selecting a type and pressing [SHIFT] + [EDIT], you can copy or exchange Motion Sequences. For details, see “Copying or Exchanging Motion Sequences” (page 95).

Settings: 1–8

Sync Part (Super Knob Motion Sequencer Sync Part)

Determines which Part is synchronized with the Super Knob Motion Sequencer. This setting is applied to the Note On Setting and the Arp/Motion Seq Grid setting for the selected Part.

Settings: Part 1 – Part 16

Arp/MS Grid (Arpeggio/Motion Sequencer Grid)

Determines the type of note that serves as the basis for the Quantize or Swing. The parameter value is displayed in clocks.

For the Motion Sequencer, this parameter value is one step length. This setting is applied to the Part which is selected as the Sync Part (above).

Settings: 60 (32nd note), 80 (16th note triplet), 120 (16th note), 160 (8th note triplet), 240 (8th note), 320 (1/4 note triplet), 480 (1/4 note)

Random (Super Knob Motion Sequencer Random)

Determines the degree to which the Step Value of the Sequence is randomly changed.

Settings: 0–127

Sync (Super Knob Motion Sequencer Sync)

Determines if the playback of the Motion Sequence applied to the Super Knob is synchronized to the Tempo, Beat, or Arpeggio of the Performance.

Settings: Off, Tempo, Beat, Arp

Off: Super Knob Motion Sequencer plays back according to its own clock and is not synchronized to an external clock.

Tempo: Super Knob Motion Sequencer is synchronized with the Performance tempo.

Beat: Super Knob Motion Sequencer is synchronized with the beat.

Arp: Super Knob Motion Sequencer is synchronized with the 1st beat of the measure of the currently playing Arpeggio.

Speed (Super Knob Motion Sequencer Speed)

Determines the speed of the playback of the Motion Sequence.

This parameter is active when the Super Knob Motion Sequencer Sync is “Off.”

Settings: 0–127

Unit Multiply (Super Knob Motion Sequencer Unit Multiply)

Adjusts the Super Knob Motion Sequencer playback time.

This parameter is active when the Super Knob Motion Sequencer Sync is “Off.”

Settings: 50%–6400%, Common

200%: The playback time will be doubled and the tempo is halved.

100%: The normal playback time.

50%: The playback time will be halved and the tempo doubled.

Common: The value set in the Unit Multiply common to the all Parts will be applied.

Key On Reset (Super Knob Motion Sequencer Key On Reset)

Determines whether or not the playback of the Motion Sequence is stopped when you play the keyboard.

This parameter is active when the Super Knob Motion Sequencer Sync is set to something other than “Arp.”

Also this parameter is not available when “Trigger” is set to “On.”

Settings: Off, Each-On, 1st-On

Each-On: The Sequence resets with each note you play and starts the Sequence from the beginning.

1st-On: The Sequence resets with each note you play and starts the Sequencer from the beginning. If you play a second note while the first is being held, the Sequence continues cycling according to the same phase as triggered by the first note—in other words, the Sequence only resets if the first note is released before the second is played.

Performance

Home

Motion Control

Overview

Quick Edit

Arpeggio

Motion Seq

Super Knob

▶ Knob Auto

Mixing

Scene

Play / Rec

MIDI

Audio

Loop (Super Knob Motion Sequencer Loop)

Determines whether the Motion Sequence is played only once or repeatedly.

Settings: Off, On

Velocity Limit (Super Knob Motion Sequencer Velocity Limit)

Determines the minimum and maximum Velocity values over which the Motion Sequence responds.

Settings: 1–127

Cycle (Super Knob Motion Sequencer Cycle)

Selects the desired step length for the Motion Sequence.

Settings: 1–16

Load Sequence

Loads Motion Sequence data in the User Memory. For details about Loading, see “Load” (page 198).

Edit Sequence

Calls up the Motion Sequence Setting display. You can create a custom Sequence consisting of up to sixteen steps.

Performance

Home

Motion Control

Overview

Quick Edit

Arpeggio

Motion Seq

Super Knob

▶ Knob Auto

Mixing

Scene

Play / Rec

MIDI

Audio

Motion Seq Step Value

Motion Seq Step Type

Cycle (Super Knob Motion Sequencer Cycle)

Selects the desired step length for the Motion Sequence.

Settings: 1–16

Amplitude (Super Knob Motion Sequencer Amplitude)

Determines how the entire Motion Sequence changes.

Settings: 0–127

Smooth (Super Knob Motion Sequencer Smoothness)

Determines the smoothness of the time change of the Motion Sequence.

Settings: 0–127

Sequence Select (Super Knob Motion Sequence Select)

Determines the Motion Sequence Type.

By selecting a type and pressing [SHIFT] + [EDIT], you can copy or exchange Motion Sequences. For details, see “Copying or Exchanging Motion Sequences” (page 95).

Settings: 1–8

Polarity (Super Knob Motion Sequencer Polarity)

Determines the Sequence Polarity.

Settings: Unipolar, Bipolar

Unipolar: Unipolar changes only in a positive direction from a base parameter value according to the Sequence.

Bipolar: Bipolar changes in both of positive and negative directions from a base parameter value.

Motion Seq Step Value (Super Knob Motion Sequencer Step Value)

Determines the Step Value for the Motion Sequence. You can control the Step Value 1–4, 5–8, 9–12 or 13–16 by the Control Sliders 1–4 depending on the cursor position on the display.

Settings: 0–127

Motion Seq Step Type (Super Knob Motion Sequencer Step Type)

Determines each Step Type of the Motion Sequence. You can switch between the Step Types A and B for the Step 1–4, 5–8, 9–12 or 13–16 by the SCENE [1/5]–[4/8] buttons depending on the cursor position on the display.

Settings: A, B

Pulse A / Pulse B (Super Knob Motion Sequencer Step Curve Type)

Determines the Curve Type of the parameter for each of “Pulse A” and “Pulse B.” “Motion Seq Step Type” described above determines which curve set here is used for each step. The vertical axis indicates the step value and the horizontal axis indicates the time. For detail about the curve shapes, see [page 102](#).

Settings: For Preset Bank: Standard, Sigmoid, Threshold, Bell, Dogleg, FM, AM, M, Discrete Saw, Smooth Saw, Triangle, Square, Trapezoid, Tilt Sine, Bounce, Resonance, Sequence, Hold

For User Bank: User 1–32

When a Library file is read: Curves in Library 1–8

Direction (Super Knob Motion Sequencer Step Curve Direction)

Determines the Direction of the Step Curve for the Motion Sequence.

Settings: Forward, Reverse

Prm1 / Prm2 (Super Knob Motion Sequencer Step Curve Parameter)

Adjusts the shape of the Step Curve for the Motion Sequence.

This parameter is not available depending on the Curve Type. Also the range of available parameter values differs depending on the Curve Type.

Control (Super Knob Motion Sequencer Step Curve Shape Control Switch)

Determines whether or not to control the shape of the Step Curve for the Motion Sequence by operating Knobs. This parameter is displayed only when “MS FX” is set to on. Also this parameter is not available depending on the Curve Type.

Settings: Off, On

Store Sequence

Stores the edited Motion Sequence data. For details about storing data, see “Store/Save” ([page 201](#)).

Performance

Home

Motion Control

Overview

Quick Edit

Arpeggio

Motion Seq

Super Knob

▶ Knob Auto

Mixing

Scene

Play / Rec

MIDI

Audio

Mixing

From the Mixing display you can adjust the volume and effect settings for each Part.

NOTE The settings in the Mixing display are stored as part of Performance data.

Mixing

Operation [PERFORMANCE (HOME)] → [Mixing]



Part 1-16 / Audio Switch

Part 1-16 / Audio Switch

Switches between the displays of the Mixing settings for Parts 1–16 or the Mixing settings for Parts 1–8, the Audio Part, the Digital Part, and the Master.

Settings: Part 1-16, Audio

Performance

Home

Motion Control

Overview

Quick Edit

Arpeggio

Motion Seq

Super Knob

Knob Auto

▶ Mixing

Scene

Play / Rec

MIDI

Audio

■ When one of Parts 1–16 is selected

Determines the Mixing setting for each Part 1–16.

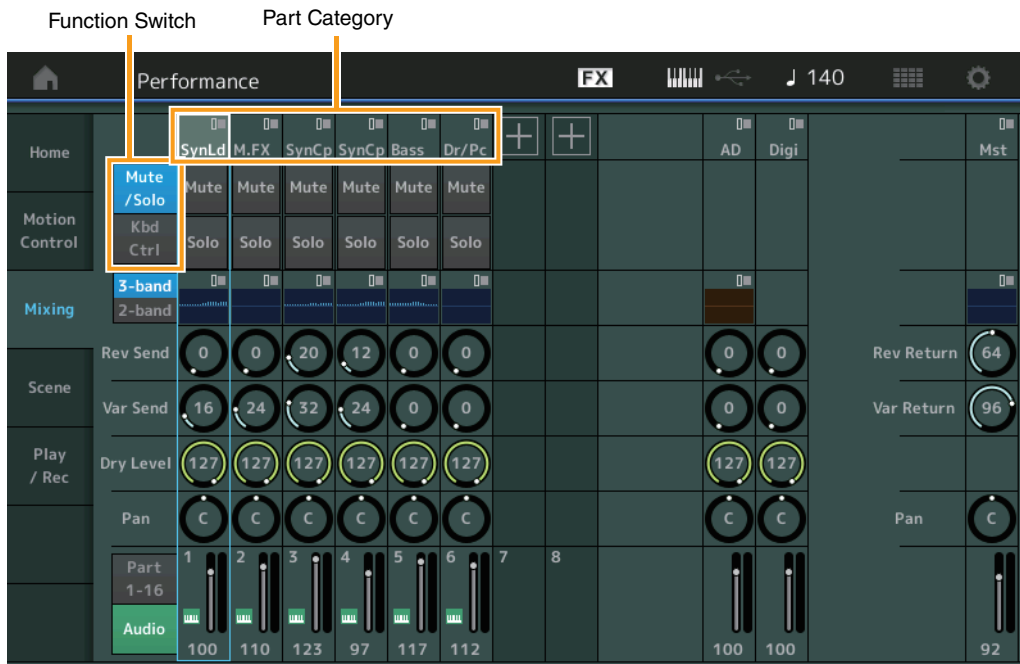

Performance

Home

Motion Control

Overview

Quick Edit

Arpeggio

Motion Seq

Super Knob

Knob Auto

▶ Mixing

Scene

Play / Rec

MIDI

Audio

Part Category

Indicates the Main category for the Part.

Settings: See the Data List PDF document.

Function Switch

Determines the Mute/Solo setting and the Keyboard Control settings for the selected Part 1–16.

Settings: Mute/Solo, Kbd Ctrl

• When “Mute/Solo” is selected

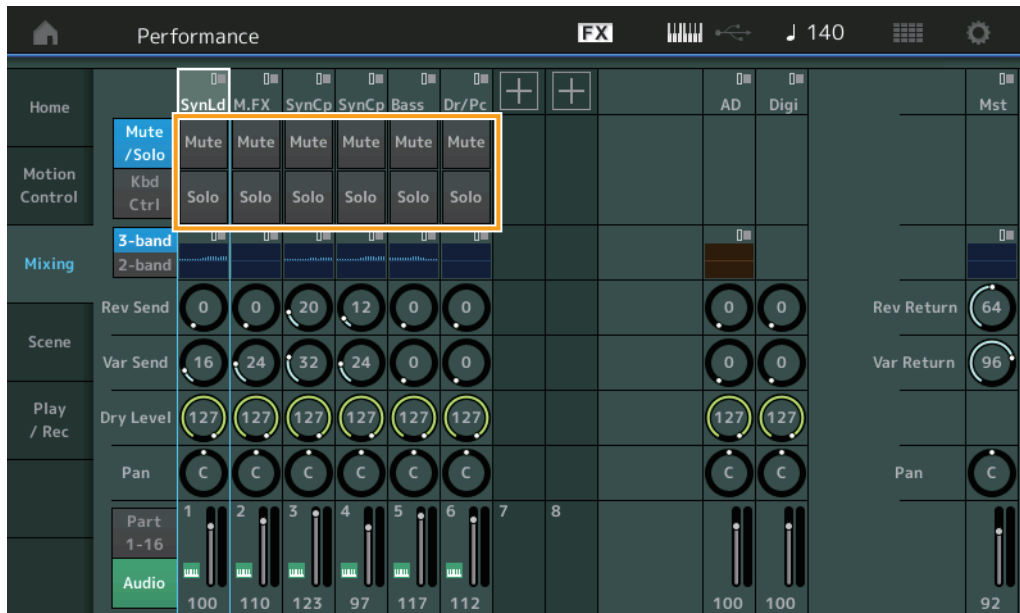

Mute/Solo (Part Mute/Solo)

Turns the Mute/Solo function on/off for the selected Part 1–16. When the function is on, this button lights.

Settings: Off, On

- When “Kbd Ctrl” is selected



Performance

Home

Motion Control

Overview

Quick Edit

Arpeggio

Motion Seq

Super Knob

Knob Auto

▶ Mixing

Scene

Play / Rec

MIDI

Audio

Kbd Ctrl (Keyboard Control)

Turns the Keyboard Control function on/off for the selected Part 1–8. When the function is on, this button lights.

Settings: Off, On

3-band/2-band Switch

EQ

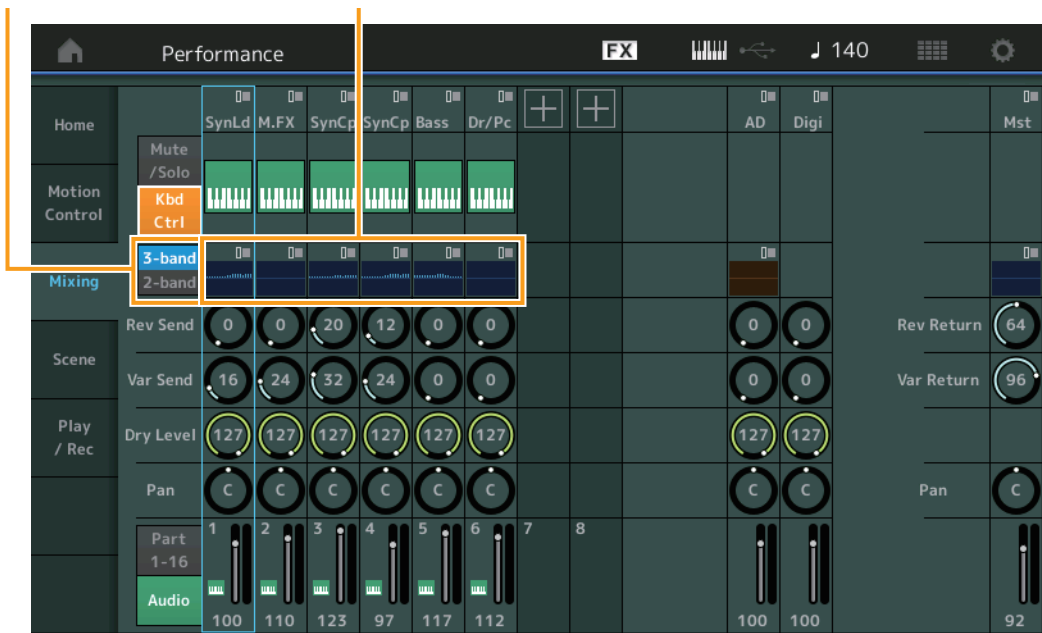

3-band/2-band Switch (3-band EQ/2-band EQ Switch)

Switches between the displays of the 3-band EQ or the 2-band EQ for Parts 1–16.

Settings: 3-band, 2-band

EQ (Equalizer)

Displays the 3-band EQ or the 2-band EQ depending on the “3-band/2-band” setting. Touching the button calls up the menu of Part EQ Edit.

Rev Send (Reverb Send)

Adjusts the Reverb send level of the selected Part 1–16.

Settings: 0–127

Var Send (Variation Send)

Adjusts the Variation send level of the selected Part 1–16.

Settings: 0–127

Dry Level

Determines the level of the unprocessed (dry) sound of the selected Part 1–16.

Settings: 0–127

Pan

Determines the stereo pan position of the selected Part 1–16.

Settings: L63–C–R63

Volume (Part Volume)

Determines the output level of the selected Part 1–16.

Settings: 0–127

■ **When “AD” Audio Part or “Digi” Digital Part is selected**

Determines the Mixing setting of the Audio/Digital Part.

A/D Part EQ

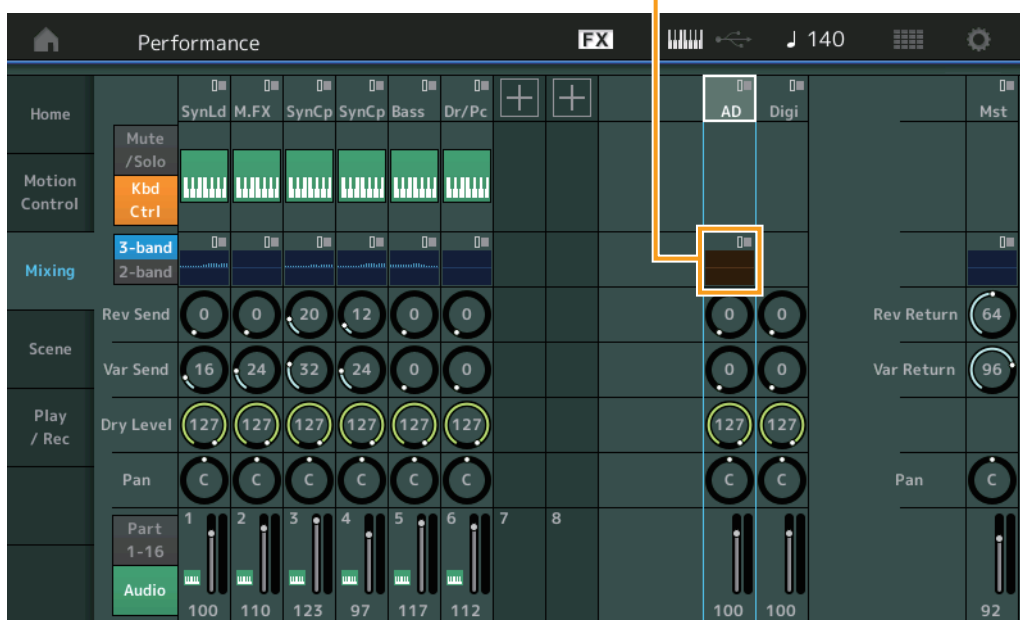
**A/D Part EQ (Audio Part Equalizer)**

Displays the 2-band parametric EQ.

Touching the button calls up the menu of Common/Audio Part EQ Edit.

A/D Part Rev Send (Audio Part Reverb Send)**Digital Part Rev Send (Digital Part Reverb Send)**

Adjusts the Reverb send level of the Audio Part/Digital Part.

Settings: 0–127

A/D Part Var Send (Audio Part Variation Send)**Digital Part Var Send (Digital Part Variation Send)**

Adjusts the Variation send level of the Audio Part/Digital Part.

Settings: 0–127

A/D Part Dry Level (Audio Part Dry Level)**Digital Part Dry Level**

Determines the level of the unprocessed (dry) sound of the Audio Part/Digital Part.

Settings: 0–127

Performance

Home

Motion Control

Overview

Quick Edit

Arpeggio

Motion Seq

Super Knob

Knob Auto

▶ Mixing

Scene

Play / Rec

MIDI

Audio

A/D Part Pan (Audio Part Pan)**Digital Part Pan**

Determines the stereo pan position of the Audio Part/Digital Part.

Settings: L63–C–R63

A/D Volume (Audio Part Volume)**Digital Part Volume**

Determines the output level of the Audio Part/Digital Part.

Settings: 0–127

■ **When “Mst” (Master Part) is selected**

Determines the Master Mixing settings.

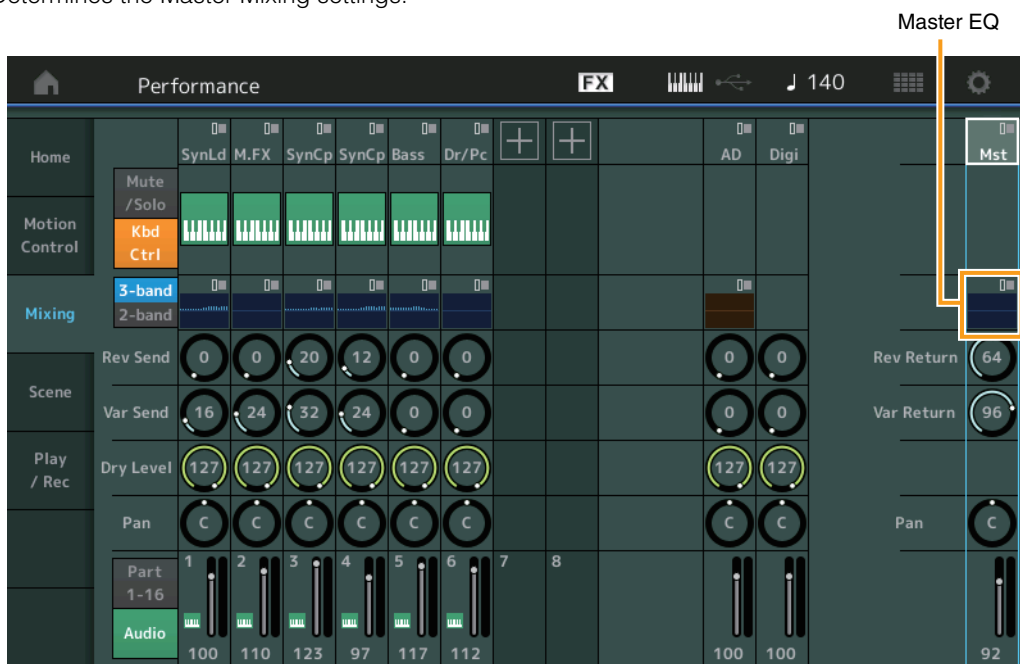
**Master EQ (Master Equalizer)**

Displays the 5-band parametric EQ.

Touching the button calls up the menu of Master EQ Edit.

Rev Return (Reverb Return)**Var Return (Variation Return)**

Determines the return level of the Reverb/Variation effect.

Settings: 0–127

Pan (Performance Pan)

Determines the stereo pan position of the entire Performance. This parameter offsets the same parameter in the Part Edit setting.

Settings: L63–C–R63

Performance Volume

Determines the output level of the entire Performance.

Settings: 0–127

Performance

Home

Motion Control

Overview

Quick Edit

Arpeggio

Motion Seq

Super Knob

Knob Auto

▶ Mixing

Scene

Play / Rec

MIDI

Audio

Scene

With the Scene function, you can store all parameter settings such as Arpeggio type, Motion Sequencer type, and the Part parameter values together as a “Scene.” There are eight Scenes and you can select them by pressing the [SCENE] button. From the Scene display you can edit parameters related to the Scene function.

When [Memory] is turned on for the function, the Motion Sequencer type, or the Arpeggio type, the corresponding function information is automatically memorized to the currently selected [SCENE] button. For information on how to use the Scene function, see the Owner’s Manual.

NOTE You can also change Scene Settings from any other operation displays. To do this, set the parameter value available for the Scene by operating the corresponding Knob or Control Slider, and press one of the SCENE [1/5]–[4/8] buttons while holding down the [SHIFT] button. Scenes 1 to 8 are assigned to each button.

Scene

Operation [PERFORMANCE (HOME)] → [Scene]

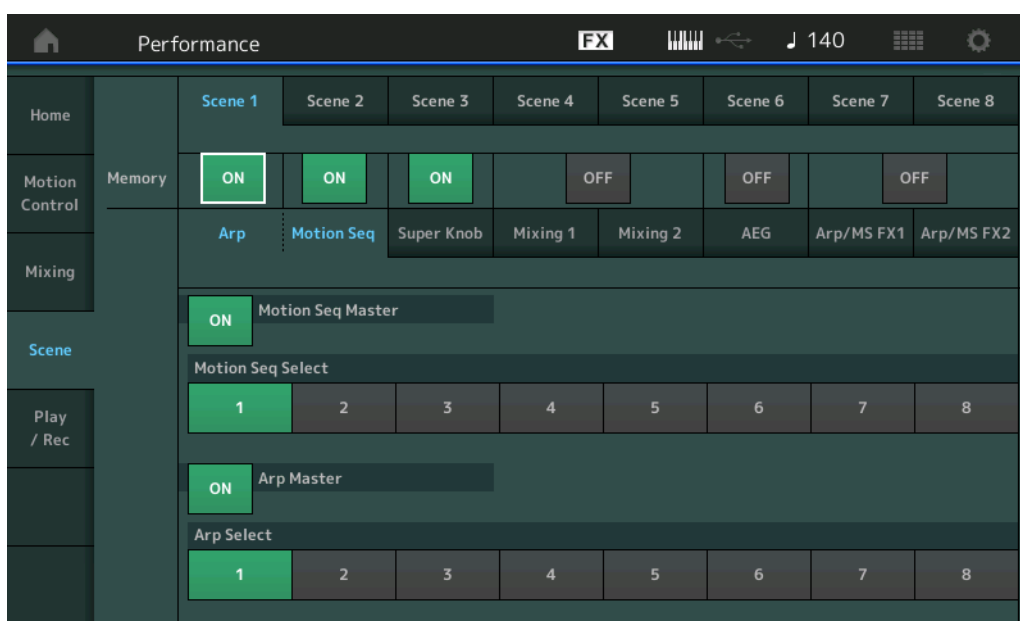

Scene Select

Switches Scenes by selecting tabs. This setting is applied to the SCENE [1/5]–[4/8] buttons on the panel.

Settings: 1–8

Memory (Memorize Switch)

Determines whether or not to memorize each parameter (such as Arpeggio, Motion Sequencer, Super Knob, Mixing, Amplitude EG, and Arp/MS FX) as a Scene. When this is off, the parameter is not displayed even when the corresponding tab is selected.

Settings: Off, On

■ When the “Arp/Motion Seq” tab is selected and both Memorize Switches for “Arp” and “Motion Seq” are set to ON

Motion Seq Master (Motion Sequencer Master Switch)

Determines whether Motion Sequencer is set to ON or OFF for the entire Performance in the selected Scene.

Settings: Off, On

Motion Seq Select (Motion Sequence Select)

Determines the Motion Sequence type for the selected Scene.

By selecting a type and pressing [SHIFT] + [EDIT], you can copy or exchange Motion Sequences. For details, see “Copying or Exchanging Motion Sequences” (page 95).

Settings: 1–8

Performance

Home

Motion Control

Overview

Quick Edit

Arpeggio

Motion Seq

Super Knob

Knob Auto

Mixing

▶ Scene

Play / Rec

MIDI

Audio

Arp Master (Arpeggio Master Switch)

Determines whether Arpeggio is set to ON or OFF for the entire Performance in the selected Scene.

Settings: Off, On

Arp Select (Arpeggio Select)

Determines the Arpeggio type for the selected Scene.

Settings: 1–8

- When the “Super Knob” tab is selected and the corresponding Memorize Switch is set to ON

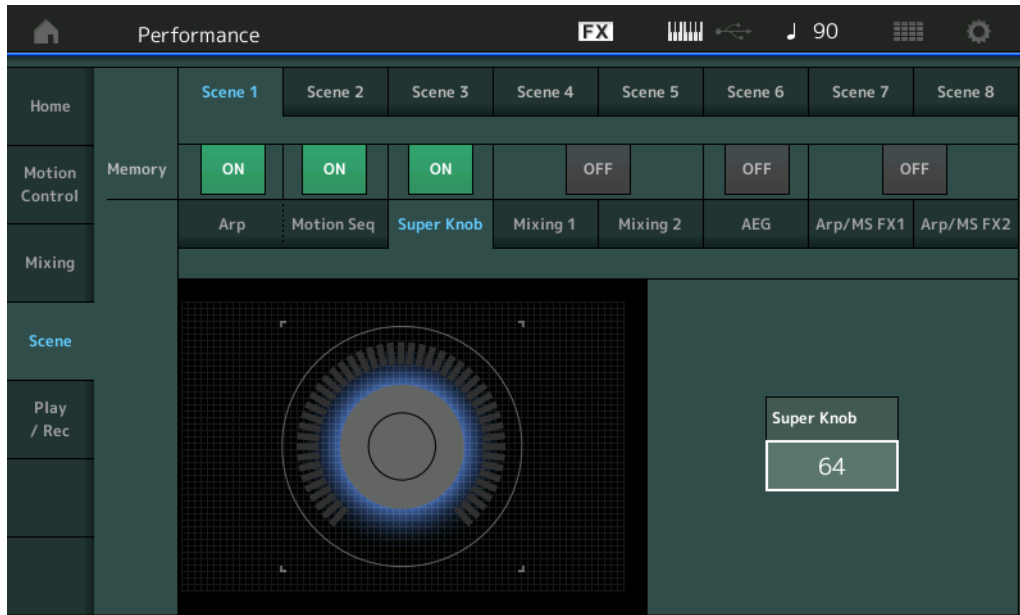

Super Knob (Super Knob Value)

Determines the Super Knob Value for the selected Scene.

Settings: 0–127

- When the “Mixing 1” tab is selected and the corresponding Memorize Switch is set to ON



Rev Send (Reverb Send)

Adjusts the Reverb Send level of each Part in the selected Scene.

Settings: 0–127

Performance

Home

Motion Control

Overview

Quick Edit

Arpeggio

Motion Seq

Super Knob

Knob Auto

Mixing

Scene

Play / Rec

MIDI

Audio

Var Send (Variation Send)

Adjusts the Variation Send level of each Part in the selected Scene.

Settings: 0–127

Dry Level

Determines the level of the unprocessed (dry) sound for each Part in the selected Scene.

Settings: 0–127

Pan

Determines the stereo pan position for each Part in the selected Scene.

Settings: L63–C–R63

Volume (Part Volume)

Determines the volumes of each Part in the selected Scene.

Settings: 0–127

- When the “Mixing 2” tab is selected and the corresponding Memorize Switch is set to ON

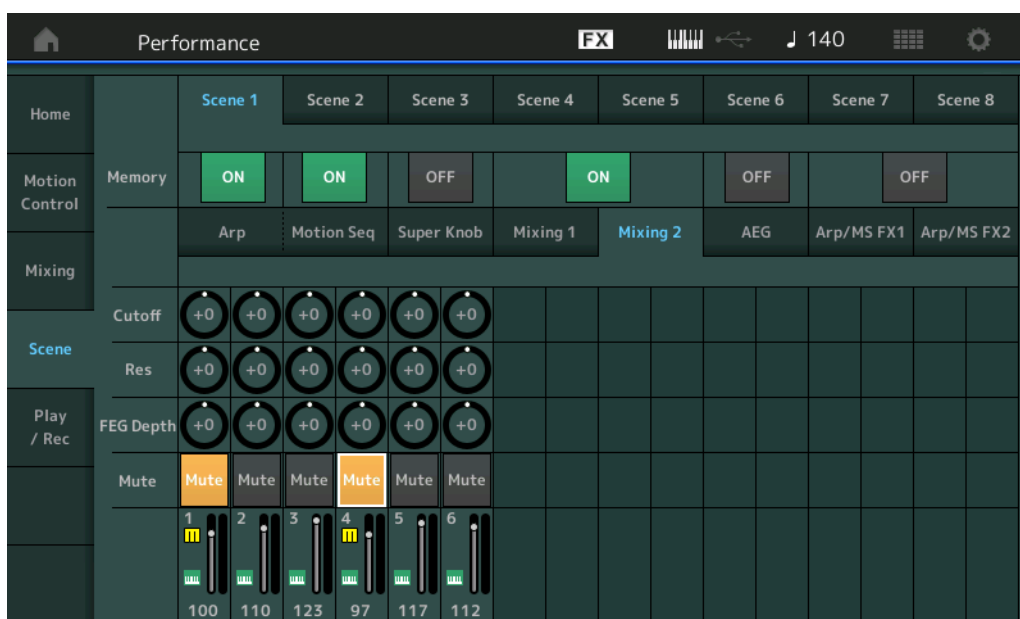
**Cutoff**

Determines the Cutoff frequency for each Part in the selected Scene.

Settings: -64 – +63

Res (Resonance)

Determines the resonance for each Part in the selected Scene.

Settings: -64 – +63

FEG Depth

Determines the Filter Envelope Generator depth (amount of Cutoff Frequency) for each Part in the selected Scene.

Settings: -64 – +63

Mute (Part Mute)

Determines the Mute setting for each Part in the selected Scene.

Settings: Off, On

Performance

Home

Motion Control

Overview

Quick Edit

Arpeggio

Motion Seq

Super Knob

Knob Auto

Mixing

▶ Scene

Play / Rec

MIDI

Audio

- When the “AEG” tab is selected and the corresponding Memorize Switch is set to ON

The screenshot shows the Performance screen with the AEG tab selected. The top bar displays 'Performance', 'FX', and a tempo of 140. Below the top bar are eight scene buttons (Scene 1 to Scene 8). The main interface is divided into sections: Home, Motion Control, Mixing, Scene, and Play / Rec. The Motion Control section shows 'Memory' switches for each scene, with Scene 1, 2, 4, 5, and 6 set to 'ON', and Scene 3, 7, and 8 set to 'OFF'. The Mixing section shows various knobs for 'Arp', 'Motion Seq', 'Super Knob', 'Mixing 1', 'Mixing 2', 'AEG', 'Arp/MS FX1', and 'Arp/MS FX2'. The Scene section shows 'Attack' settings for six parts, with values of +15, +15, +15, +15, +15, and +15. The Play / Rec section shows 'Decay', 'Sustain', and 'Release' settings for the same six parts. The Release settings are +0, +0, +0, +40, +40, and +40.

Performance

Home

Motion Control

Overview

Quick Edit

Arpeggio

Motion Seq

Super Knob

Knob Auto

Mixing

▶ Scene

Play / Rec

MIDI

Audio

Attack (AEG Attack Time)

Determines the AEG Attack Time for each Part in the selected Scene.

Settings: -64 – +63

Decay (AEG Decay Time)

Determines the AEG Decay Time for each Part in the selected Scene.

Settings: -64 – +63

Sustain (AEG Sustain Level)

Determines the AEG Sustain Level for each Part in the selected Scene.

Settings: -64 – +63

Release (AEG Release Time)

Determines the AEG Release Time for each Part in the selected Scene.

Settings: -64 – +63

- When the “Arp/MS FX 1” tab is selected and the corresponding Memorize Switch is set to ON

The screenshot shows the Performance screen with the Arp/MS FX 1 tab selected. The top bar displays 'Performance', 'FX', and a tempo of 140. Below the top bar are eight scene buttons (Scene 1 to Scene 8). The main interface is divided into sections: Home, Motion Control, Mixing, Scene, and Play / Rec. The Motion Control section shows 'Memory' switches for each scene, with Scene 1, 2, 4, 5, 6, and 8 set to 'ON', and Scene 3, 7, and 8 set to 'OFF'. The Mixing section shows various knobs for 'Arp', 'Motion Seq', 'Super Knob', 'Mixing 1', 'Mixing 2', 'AEG', 'Arp/MS FX1', and 'Arp/MS FX2'. The Scene section shows 'Swing' settings for six parts, with values of +0, +0, +0, +0, +0, and +0. The Play / Rec section shows 'Unit', 'Gate Time', and 'Velocity' settings for the same six parts. The Unit settings are 50%, 100%, 100%, 50%, 100%, and 100%. The Gate Time settings are 100%, 100%, 100%, 100%, 100%, and 100%. The Velocity settings are 100%, 100%, 100%, 100%, 100%, and 100%.

Swing

Determines the Swing setting of Arpeggio and Motion Sequencer for each Part in the selected Scene. For details about Swing, see “Quick Edit” (page 40).

Settings: -120 – +120

Unit (Part Unit Multiply)

Determines the Unit Multiply setting of Arpeggio and Motion Sequencer for each Part in the selected Scene.

Settings: 50%–400%, Common

200%: The playback time will be doubled and the tempo is halved.

100%: The normal playback time.

50%: The playback time will be halved and the tempo doubled.

Common: The value set in the Unit Multiply common to the all Parts will be applied.

Gate Time (Gate Time Rate)

Determines the Gate Time Rate of Arpeggio for each Part in the selected Scene.

Settings: 0%–200%

Velocity (Velocity Rate)

Determines the Velocity Rate of Arpeggio for each Part in the selected Scene.

Settings: 0%–200%

- When the “Arp/MS FX 2” tab is selected and the corresponding Memorize Switch is set to ON

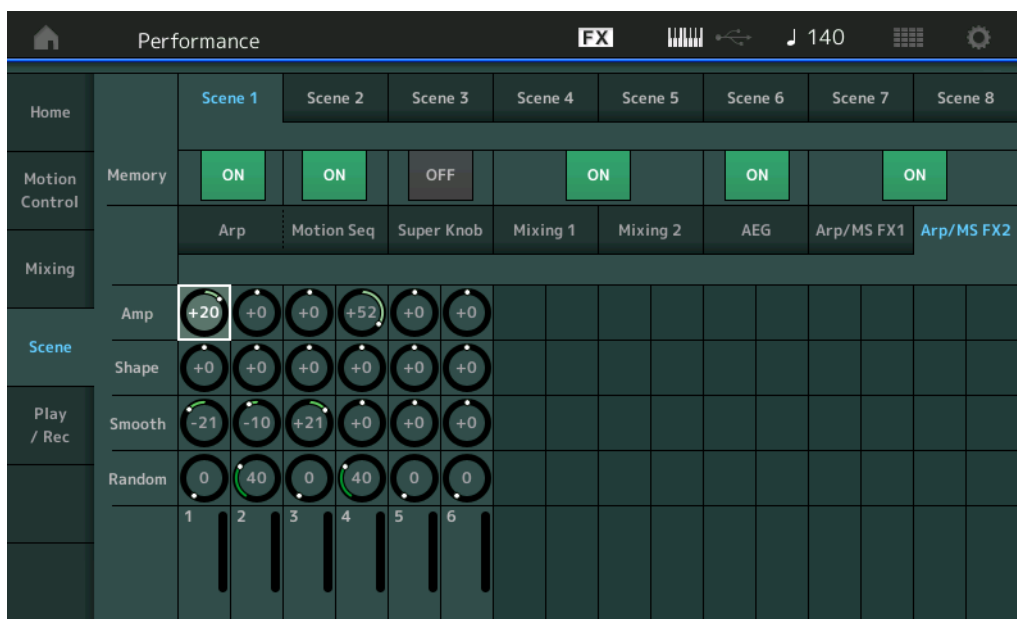

Amp (Motion Sequencer Amplitude)

Determines the Amplitude of Motion Sequencer for each Part in the selected Scene. For details about Amplitude, see “Quick Edit” (page 37).

Settings: -64 – +63

Shape (Motion Sequencer Pulse Shape)

Determines the Pulse Shape of Motion Sequencer for each Part in the selected Scene. For details about Pulse Shape, see “Quick Edit” (page 37).

Settings: -100 – +100

Smooth (Motion Sequencer Smoothness)

Determines the Smoothness of Motion Sequencer for each Part in the selected Scene. For details about Smoothness, see “Quick Edit” (page 38).

Settings: -64 – +63

Random (Motion Sequencer Random)

Determines the “Random” of Motion Sequence for each Part in the selected Scene. For details about Random, see “Quick Edit” (page 38).

Settings: 0–127

Performance

Home

Motion Control

Overview

Quick Edit

Arpeggio

Motion Seq

Super Knob

Knob Auto

Mixing

▶ Scene

Play / Rec

MIDI

Audio

Play/Rec

You can playback/record MIDI data as Songs on this instrument itself or playback/record your performance (audio data) on a USB flash drive.

Play/Rec

MIDI

From the MIDI display you can playback/record your keyboard performance with using the selected Performance to the Song. You can playback/record knob operations, controller operations and Arpeggio playback as well as your keyboard playing to the specified Track as MIDI events.

■ Playback and Playback Standby

Operation

Press the [▶] (Play) button
or
[PERFORMANCE (HOME)] → [Play/Rec] → [MIDI]

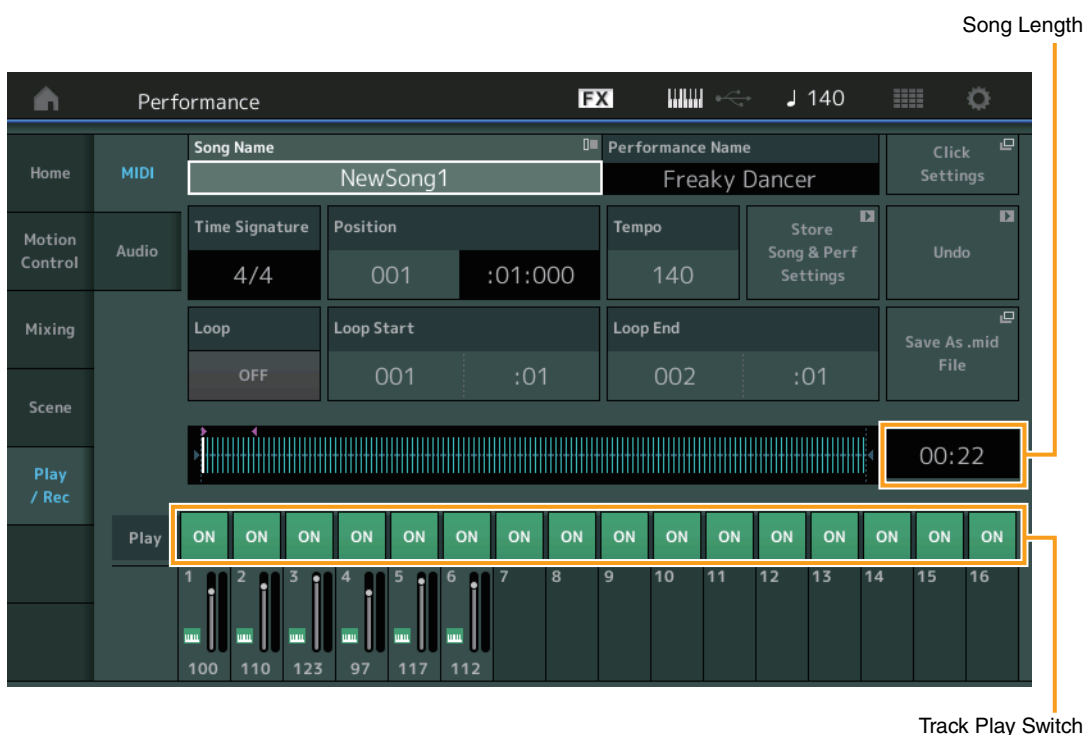

Song Name

Indicates the selected Song name. Touching the Song Name calls up a menu for selecting Load, Rename, New Song and User Arpeggio.

Performance Name

Indicates the selected Performance Name.

Click Settings

Shows the Tempo settings display.

Time Signature

Indicates the meter of the Song.

Position (Song Position)

Determines the starting position of Recording/Playback. The indicator also shows the current position during playback.

The measure's number is in the left cell and the beat number and clocks are in the right cell.

Performance

Home

Motion Control

Overview

Quick Edit

Arpeggio

Motion Seq

Super Knob

Knob Auto

Mixing

Scene

▶ Play / Rec

▶ MIDI

Audio

Tempo

Determines the Song tempo.

Settings: 5–300

NOTE The tempo can be set as follows.

[PERFORMANCE (HOME)] → [UTILITY] → [Tempo Settings] (page 207)

Store Song & Perf Settings

Changes the Song tempo, Loop settings, and the Performance called back along with the Song to the current settings.

This parameter is not available during:

- New recording (No previously recorded Song data.)
- Playback
- Recording Standby
- Recording

Loop

Determines whether the Song plays through a single time or continuously. When this is set to on, the Song is repeatedly played back between the “Loop Start” and “Loop End” points (below).

Settings: Off, On

Loop Start / End

Determines the start position and the end position of Loop playback. The measure number is in the left cell and the beat number is in the right cell. This is not available when “Loop” is set to off.

Save As .mid File

Calls up the Store/Save display to save the Song as a file.

This button is not available during:

- New recording (No previously recorded Song data.)
- Playback
- Recording Standby
- Recording
- An external memory such as a USB flash drive is not connected.

Song Length

Indicates the length of the entire sequence.

Track Play Switch

Switches the playback for each track on/off.

Settings: Off, On

Performance

Home

Motion Control

Overview

Quick Edit

Arpeggio

Motion Seq

Super Knob

Knob Auto

Mixing

Scene

Play / Rec

▶ MIDI

Audio

Record and Record Standby

Operation

Press the [●] (Record) button
or
[PERFORMANCE (HOME)] → [Play/Rec] → [MIDI] → [●] (Record) button

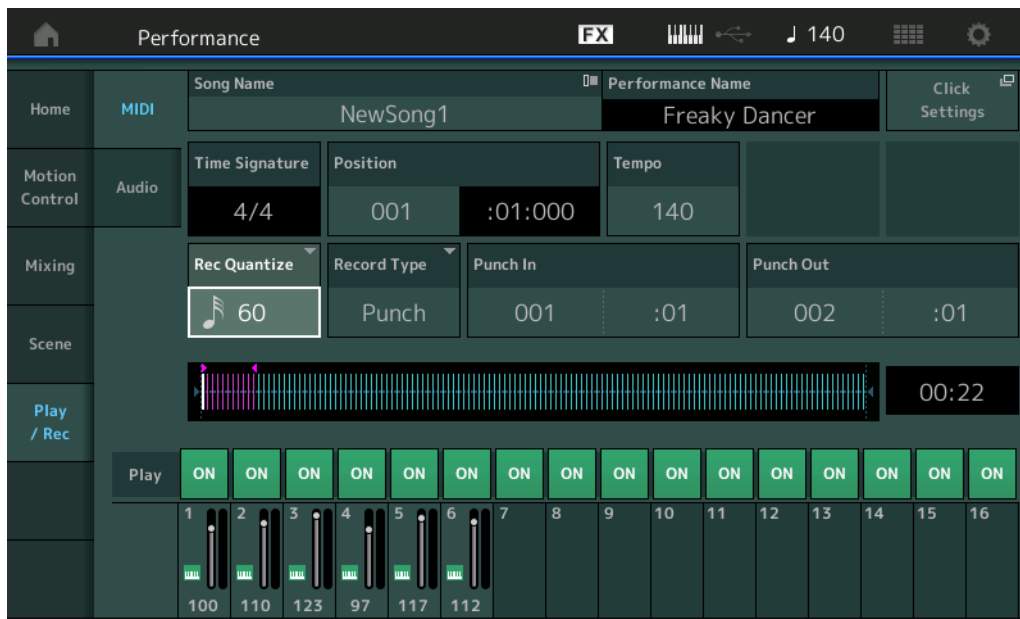

Performance

Home

Motion Control

Overview

Quick Edit

Arpeggio

Motion Seq

Super Knob

Knob Auto

Mixing

Scene

Play / Rec

MIDI

Audio

Time Signature

Determines the meter of the Song.

Settings: 1/16–16/16, 1/8–16/8, 1/4–8/4

Rec Quantize (Record Quantize)

Quantization is the process of adjusting the timing of note events by moving them closer to the nearest exact beat. You can use this feature, for example, to improve the timing of a performance recorded in real time. Record quantize aligns the timing of notes automatically, as you record.

Settings: 60 (32nd note), 80 (16th note triplet), 120 (16th note), 160 (8th note triplet), 240 (8th note), 320 (1/4 note triplet), 480 (1/4 note), Off

Record Type

Determines the Recording Type. This parameter is not available for the first recording.

Settings: Replace, Overdub, Punch

Replace: You can use this method when you want to overwrite an already recorded Track with new data in real time. The original data will be erased.

Overdub: You can use this method when you want to add more data to a Track that already contains data. Previously recorded data will be maintained.

Punch: You can use this method when you want to overwrite data to a specified range of a Track that already contains data. It allows you to overwrite the already recorded data from the starting point to the ending point (measure/beat) that was specified before recording.

Punch In

Determines the starting point (measure and beat) for recording. This parameter is available only when “punch” is selected for “Record Type.”

Punch Out

Determines the ending point (measure and beat) for recording. This parameter is available only when “punch” is selected for “Record Type.”

NOTE For details about the Punch In/Out setting, see the Owner's Manual.

Undo

The Undo Job cancels the changes you made in your most recent recording session, restoring the data to its previous state.

Redo

Redo is available only after using Undo, and lets you restore the changes you made before undoing them.

■ Put Track to Arpeggio

This function copies data in the specified measures of a track for creating Arpeggio data. Up to 16 unique note numbers can be recorded to the Arpeggio track. If more than 16 different note numbers have been recorded to the MIDI sequence data, the Convert operation reduces the notes in excess of the limit. Because of this, be careful to record only up to 16 different notes when you create an Arpeggio, especially when using multiple tracks.

Operation

[▶] (PLAY) button
or
[PERFORMANCE (HOME)] → [Play/Rec] → [MIDI] → Touch the Song Name to call up the menu → [User Arp] in the menu

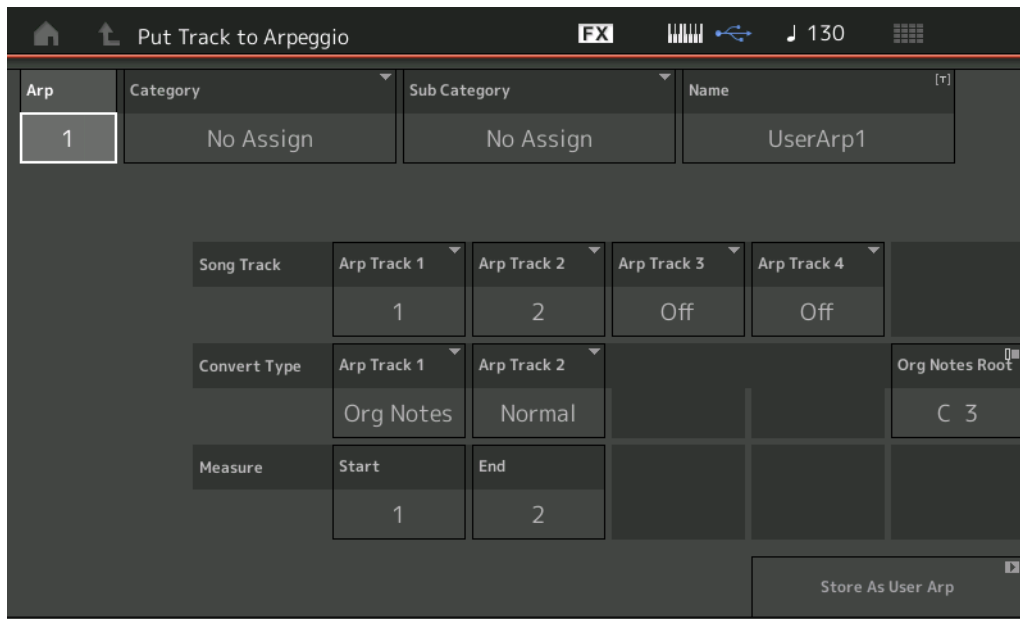

Arp (Arpeggio Number)

Determines the User Arpeggio number. One of the numbers currently not in use is automatically assigned by default. When a number already in use is selected, the previous Arpeggio data in the selected number will be overwritten.

Settings: 1–256

Category (Arpeggio Category)

Determines the Category setting (Main Category and Sub Category) for the created Arpeggio data.

Settings: Refer to the Arpeggio Type Category List in the Reference Manual PDF document.

Name (Arpeggio Name)

Determines the User Arpeggio name. The Arpeggio name can contain up to 20 characters.

Song Track

Determines the track of the source Song for each Arpeggio track.

Convert Type

Determines how the MIDI sequence data (of Song tracks) will be converted to Arpeggio data from the three ways below. This parameter can be set for each track.

Settings: Normal, Fixed, Org Notes

Normal: The Arpeggio is played back using only the played note and its octave notes.

Fixed: Playing any note(s) will trigger the same MIDI sequence data.

Org Notes (original notes): Basically same as “Fixed” with the exception that the Arpeggio playback notes differ according to the played chord.

Original Notes Root

Determines the root note when the Convert Type of any track is set to “Org Notes.” This is available only when any track is set to “Org Notes.”

Settings: C-2 – G8

Performance

Home

Motion Control

Overview

Quick Edit

Arpeggio

Motion Seq

Super Knob

Knob Auto

Mixing

Scene

Play / Rec

MIDI

Audio

Measure

Determines the range of measures to be copied to the Arpeggio data.

Settings: 001–999

Store As User Arp (Store As User Arpeggio)

Stores as User Arpeggio following all settings made in this display. This is not available when all tracks are set to off.

Audio

From the Audio display you can record your performance on the instrument as WAV format (44.1-kHz, 24-bit, stereo) audio files to a USB flash drive. It is possible to record continuously for up to 74 minutes (assuming that the USB storage device has sufficient free memory).

■ Playback and Playback Standby

Operation [PERFORMANCE (HOME)] → [Play/Rec] → [Audio]

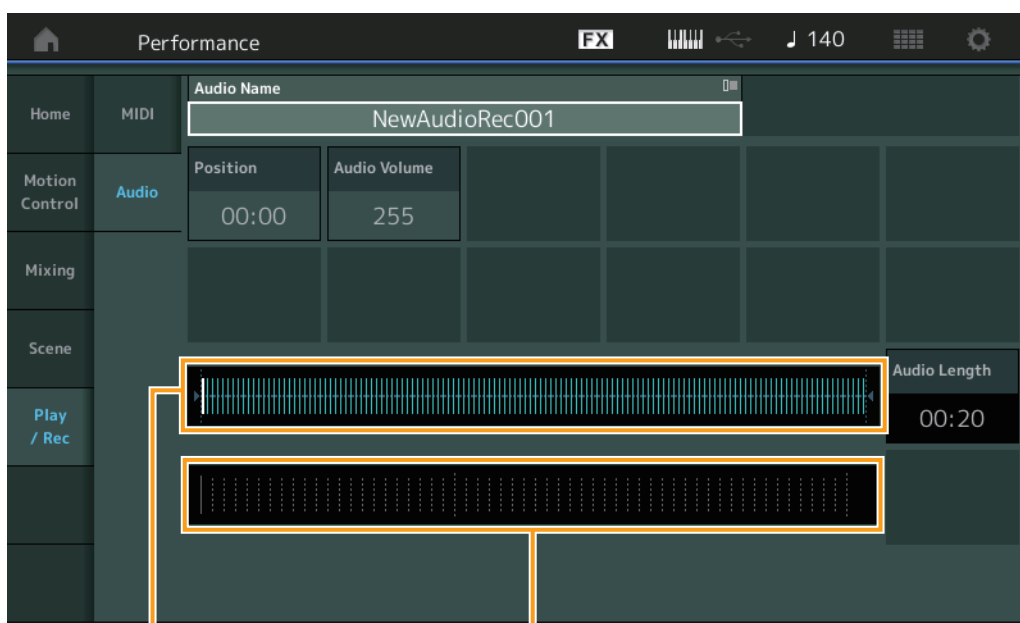

Current play position in the entire audio data

Level meter

Audio Name

Indicates the name of the selected Audio file.

Position (Audio Position)

Determines the starting position of Playback. The indicator also shows the current position during playback.

Audio Volume

Determines the volume of the Audio Playback. This parameter cannot be changed during recording.

Settings: 0–255

Audio Length

Indicates the length of the entire audio data.

Level Meter

Indicates the Audio Input/Output level.

Performance

Home

Motion Control

Overview

Quick Edit

Arpeggio

Motion Seq

Super Knob

Knob Auto

Mixing

Scene

Play / Rec

▶ MIDI

▶ Audio

■ Record and Record Standby

Operation [PERFORMANCE (HOME)] → [Play/Rec] → [Audio] → [●] (Record) button

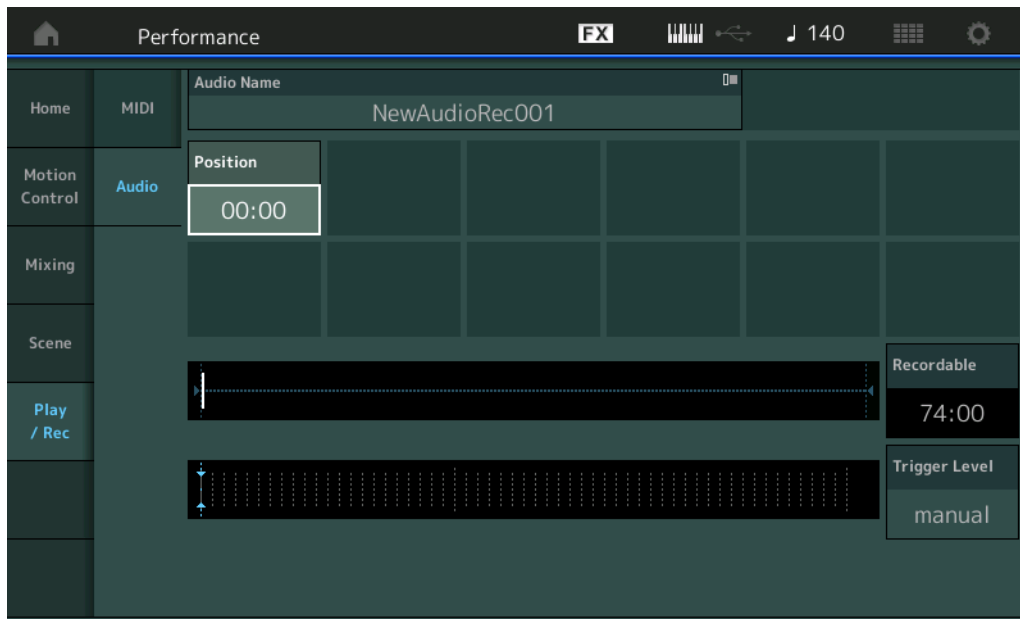

Recordable (Audio Recordable Time)

Indicates available recording time. This parameter is displayed only during recording standby.

Trigger Level

Determines the method of starting recording. This parameter is displayed only during recording standby. If you set the trigger level to “manual,” recording will begin whenever you press the [▶] (Play) button. Alternatively, if you set a value between 1 and 127, recording will begin automatically whenever the [▶] (Play) button is pressed and the playback volume exceeds that level. The level set here will be indicated by blue triangles in the level meter. For best results, set this parameter as low as possible to capture the entire signal, but not so low as to record unwanted noise.

Settings: manual, 1–127

Performance

Home

Motion Control

Overview

Quick Edit

Arpeggio

Motion Seq

Super Knob

Knob Auto

Mixing

Scene

Play / Rec

MIDI

▶ Audio

Normal Part (AWM2) Edit

A Normal Part (AWM2) (having pitched musical instrument sounds) can consist of up to eight Elements. An Element is the basic, smallest unit for a Part. There are two types of Normal Part (AWM2) Edit displays: Element Common Edit display, for editing settings common to all eight Elements; and Element Edit display, for editing individual Elements.

Element Common Edit (Common)

Part Settings

General

From the General display you can set various parameters such as Part Name, Volume, and Pan.

Operation [PERFORMANCE (HOME)] → [EDIT] → Part selection → Element [Common] → [Part Settings] → [General]

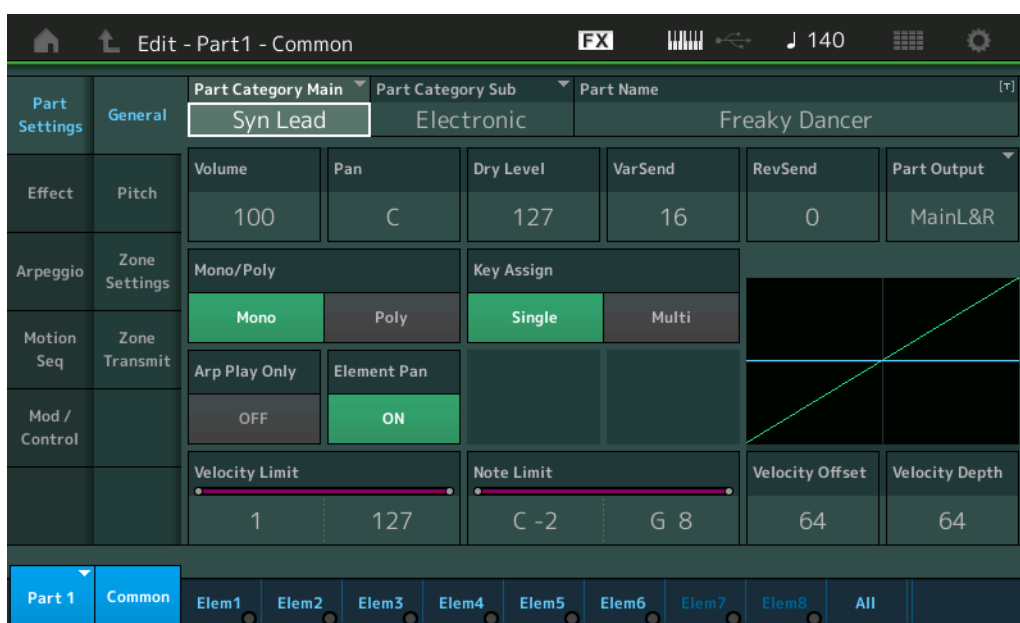

Part Category Main (Part Main Category)

Part Category Sub (Part Sub Category)

Determines the Main category and the Sub category for the selected Part.

Settings: See the Data List PDF document.

Part Name

Determines the Part name of the selected Part. Part names can contain up to 20 characters. Touching the parameter calls up the input character display.

Volume (Part Volume)

Determines the output level of the selected Part.

Settings: 0–127

Pan

Determines the stereo pan position of the selected Part.

Settings: L63–C–R63

Normal Part (AWM2) Edit

Common

Part Settings

General

Pitch

Zone Settings

Zone Transmit

Effect

Routing

Ins A

Ins B

EQ

Ins Assign

Arpeggio

Common

Individual

Advanced

Motion Seq

Common

Lane

Mod / Control

Part LFO

Control Assign

Receive SW

Element

Osc / Tune

Pitch EG

Filter

Type

Filter EG

Scale

Amplitude

Level / Pan

Amp EG

Scale

Element LFO

Element EQ

All Element

Osc

Balance

Copy or Exchange Elements

Dry Level

Determines the dry sound level (without effect processing) of the selected Part. This is available only when “Part Output” is set to “MainL&R.”

Settings: 0–127

Var Send (Variation Send)

Determines the level of the selected Part that is sent to the Variation effect. This is available only when “Part Output” is set to “MainL&R.”

Settings: 0–127

Rev Send (Reverb Send)

Determines the level of the selected Part that is sent to the Reverb effect. This is available only when “Part Output” is set to “MainL&R.”

Settings: 0–127

Part Output (Part Output Select)

Determines which audio output is used for the selected Part.

Settings: MainL&R, USB1&2...USB7&8, USB1...USB8, Off

MainL&R: Outputs in stereo (two channels) to the OUTPUT [L/MONO]/[R] jacks.

USB1&2...USB7&8: Outputs in stereo (Channels 1&2–7&8) to the [USB TO HOST] terminal.

USB1...USB8: Outputs in mono (Channels 1...8) to the [USB TO HOST] terminal.

Off: No audio signal for the Part is output.

Mono/Poly

Selects monophonic or polyphonic playback for the selected Part. Monophonic is for single notes only, and polyphonic is for playing multiple simultaneous notes.

Settings: Mono, Poly

Key Assign (Key Assign Mode)

Determines the playing method when the same notes are received continuously, and without corresponding note off messages. For details, refer to the Synthesizer Parameter Manual PDF document.

Settings: Single, Multi

Single: Double or repeated playback of the same note is not possible. The first note will be stopped, then the next note will be sounded.

Multi: All notes are sounded simultaneously. This allows playback of the same note when it is played multiple times in succession (especially for tambourine and cymbal sounds that you would want to ring out to their full decay).

Arp Play Only (Arpeggio Play Only)

Determines whether or not the current Part plays only the note events of the Arpeggio playback. When this parameter is set to on, only the note events of the Arpeggio playback affect the tone generator block.

Settings: Off, On

Element Pan (Element Pan Switch)

Determines whether the individual pan settings for each Element (made via ([EDIT] → Part selection → Element selection → [Amplitude] → [Level/Pan] → “Pan”) are applied or not. When this is set to “off,” the pan position for each Element in the Part is set to center.

Settings: Off, On

Velocity Limit

Determines the minimum and maximum values of the velocity range within which each Part will respond. Each Part will only sound for notes played within its specified velocity range. If you first specify the maximum value and then the minimum value, for example “93 to 34,” then the Velocity range covers both “1 to 34” and “93 to 127.” For instructions on setting the Velocity Limit, refer to the Owner’s Manual.

Settings: 1–127

Note Limit

Determines the lowest and highest notes of the keyboard range for each Part. Each Part will only sound for notes played within its specified range. If you first specify the highest note and then the lowest note, for example “C5 to C4,” then the note range covers both “C-2 to C4” and “C5 to G8.”

Settings: C -2 – G8

Normal Part (AWM2) Edit

Common

Part Settings

General

Pitch

Zone Settings

Zone Transmit

Effect

Routing

Ins A

Ins B

EQ

Ins Assign

Arpeggio

Common

Individual

Advanced

Motion Seq

Common

Lane

Mod / Control

Part LFO

Control Assign

Receive SW

Element

Osc / Tune

Pitch EG

Filter

Type

Filter EG

Scale

Amplitude

Level / Pan

Amp EG

Scale

Element LFO

Element EQ

All Element

Osc

Balance

Copy or Exchange Elements

Velocity Depth (Velocity Sensitivity Depth)

Determines the degree to which the resulting volume of the tone generator responds to your playing strength. The higher the value, the more the volume changes in response to your playing strength (as shown below).

Settings: 0–127

When Offset (below) is set to 64:

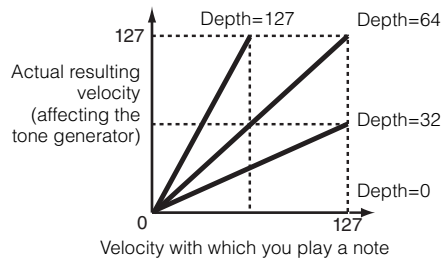

Velocity Offset (Velocity Sensitivity Offset)

Determines the amount by which played velocities are adjusted for the actual resulting velocity effect. This lets you raise or lower all velocities based on this setting value—allowing you to automatically compensate for playing too strongly or too softly.

Settings: 0–127

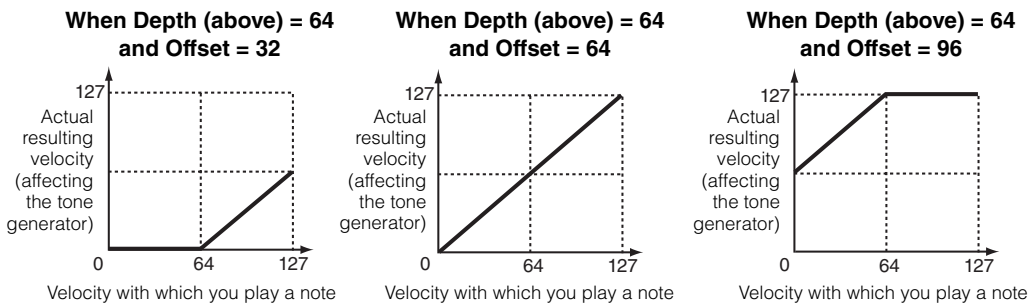

You can select a Part with touch operations within these displays: Normal Part (AWM2) Edit, Drum Part Edit, Normal Part (FM-X) Edit, and Common/Audio Edit. These instructions show an example display of Normal Part (AWM2) Edit.

Part

Shows a currently selected Part. By touching a Part, a pop-up list appears, and then you can select a different Part for editing.

Settings: Common, Part 1–16

Pitch

From the Pitch display you can set Pitch-related parameters for the Part.

Operation

[PERFORMANCE (HOME)] → [EDIT] → Part selection → Element [Common] → [Part Settings] → [Pitch]

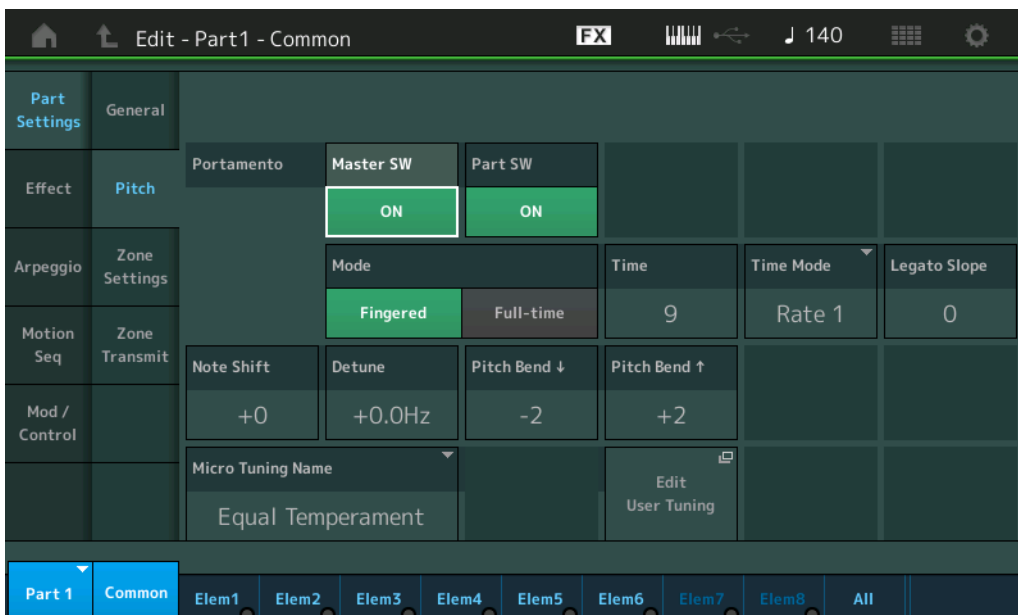

Normal Part (AWM2) Edit

Common

Part Settings

- ▶ General
- ▶ Pitch
- Zone Settings
- Zone Transmit

Effect

- Routing
- Ins A
- Ins B
- EQ
- Ins Assign

Arpeggio

- Common
- Individual
- Advanced

Motion Seq

- Common
- Lane

Mod / Control

- Part LFO
- Control Assign
- Receive SW

Element

Osc / Tune

Pitch EG

Filter

- Type
- Filter EG
- Scale

Amplitude

- Level / Pan
- Amp EG
- Scale

Element LFO

Element EQ

All Element

- Osc
- Balance

Copy or Exchange Elements

Normal Part (AWM2)

Drum Part

Normal Part (FM-X)

Common/Audio

Portamento Master SW (Portamento Master Switch)

Portamento is used to create a smooth transition in pitch from the first note played on the keyboard to the next. The Portamento Master Switch determines whether Portamento is applied to the entire Performance or not.

Settings: Off, On

Portamento Part SW (Portamento Part Switch)

Determines whether Portamento is applied to the selected Part or not.

Settings: Off, On

Portamento Mode

Determines the Portamento mode.

Settings: Fingered, Full-time

Fingered: Portamento is only applied when you play legato (playing the next note before releasing the previous one).

Full-time: Portamento is applied to all notes.

Portamento Time

Determines the pitch transition time or rate when Portamento is applied.

Settings: 0–127

Portamento Time Mode

Determines how the pitch changes in time.

Settings: Rate 1, Time 1, Rate 2, Time 2

Rate 1: Pitch changes at the specified rate.

Time 1: Pitch changes in the specified time.

Rate 2: Pitch changes at the specified rate within an octave.

Time 2: Pitch changes in the specified time within an octave.

Portamento Legato Slope

Determines the speed of the attack of legato notes, when “Mono/Poly” is set to “Mono.” (Legato notes “overlap” each other, the next being played before the previous is released.)

Settings: 0–7

Note Shift

Determines the pitch (key transpose) setting for each Part in semitones.

Settings: -24 – +0 – +24

Detune

Determines the pitch settings of the selected Part in 0.1 Hz increments.

Settings: -12.8Hz – +0.0Hz – +12.7Hz

Pitch Bend \uparrow/\downarrow (Pitch Bend Range Upper/Lower)

Determines the maximum Pitch Bend Range in semitones.

Settings: -48 – +0 – +24

Micro Tuning Name

Determines the tuning system for the selected Part. For information on the various tuning systems, see the Synthesizer Parameter Manual PDF document.

Settings: Equal Temperament, Pure Major, Pure Minor, Werckmeister, Kirnberger, Vallotti & Young, 1/4 shift, 1/4 tone, 1/8 tone, Indian, Arabic 1, Arabic 2, Arabic 3, User 1–8 (when the User Bank is selected), Library 1–1 – 8–8 (when the Library file is read)

Micro Tuning Root

Determines the root note for the Micro Tuning function. This root note setting may not be necessary depending on the “Micro Tuning Name” type.

Settings: C–B

Normal Part (AWM2) Edit

Common

Part Settings

General

Pitch

Zone Settings

Zone Transmit

Effect

Routing

Ins A

Ins B

EQ

Ins Assign

Arpeggio

Common

Individual

Advanced

Motion Seq

Common

Lane

Mod / Control

Part LFO

Control Assign

Receive SW

Element

Osc / Tune

Pitch EG

Filter

Type

Filter EG

Scale

Amplitude

Level / Pan

Amp EG

Scale

Element LFO

Element EQ

All Element

Osc

Balance

Copy or Exchange Elements

Edit User Tuning

Calls up the User Micro Tuning Setting display.



Tuning No. (Micro Tuning Number)

Indicates the selected User Micro Tuning Number.

Settings: 1–8

Tuning Name (Micro Tuning Name)

Determines the name of the selected User Micro Tuning. Touching the parameter calls up the input character display.

C, C#, D, D#, E, F, F#, G, G#, A, A#, B

Adjusts the pitch of each note in 1 cent steps determines the Micro Tuning.

Settings: -99 – +99

Initialize

Initializes the selected User Micro Tuning.

Normal Part (AWM2) Edit

Common

Part Settings

General

▶ Pitch

Zone Settings

Zone Transmit

Effect

Routing

Ins A

Ins B

EQ

Ins Assign

Arpeggio

Common

Individual

Advanced

Motion Seq

Common

Lane

Mod / Control

Part LFO

Control Assign

Receive SW

Element

Osc / Tune

Pitch EG

Filter

Type

Filter EG

Scale

Amplitude

Level / Pan

Amp EG

Scale

Element LFO

Element EQ

All Element

Osc

Balance

Copy or Exchange Elements

Zone Settings

From the Zone Setting display you can set Zone-related parameters.

You can divide the keyboard into a maximum of eight independent areas (called “Zones”). To each Zone can be assigned different MIDI channels. This makes it possible to control several Parts of the multi-timbral tone generator simultaneously by a single keyboard or to control Parts of an external MIDI instrument over several different channels in addition to the internal Parts of this synthesizer itself—letting you use the MODX to effectively do the work of several keyboards.

To activate this display, select [UTILITY] → [Settings] → [Advanced], then set “Zone Master” to “ON.” For details, refer to the Owner’s Manual.

Operation

[PERFORMANCE (HOME)] → [EDIT] → Part selection → Element [Common] → [Part Settings] → [Zone Settings]

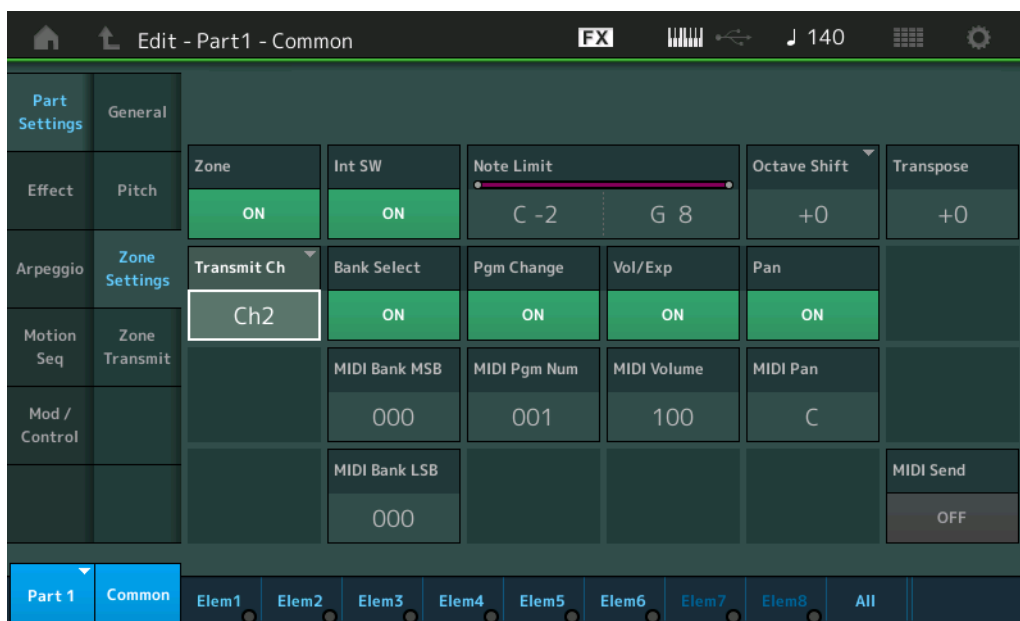

Zone (Zone Switch)

Determines whether the Zone function is used (on) or not (off). When this is set to off, all of the following parameters are not available.

Settings: Off, On

Int SW (Internal Switch)

Determines whether MIDI messages generated by playing the keyboard in the range of the selected Zone are transmitted to the internal tone generator or not.

Settings: Off, On

Transmit Ch (Transmit Channel)

Determines the MIDI Transmit Channel for the selected Zone.

Settings: Ch1–Ch16, Off

Note Limit

Determines the lowest and highest notes of the range for the selected Zone. The selected Zone will sound only when you play notes within this range. If you first specify the highest note and then the lowest note, for example “C5 to C4,” then the note range covers both “C-2 to C4” and “C5 to G8.”

Settings: C -2 – G8

Octave Shift

Determines the amount in octaves by which the range of the Zone is shifted up or down. You can adjust the offset up or down over a maximum range of three octaves.

Settings: -3 – +0 (Default) – +3

Transpose

Determines the amount in semitones by which the range of the Zone is shifted up or down.

Settings: -11 – +0 (Default) – +11

Normal Part (AWM2) Edit

Common

Part Settings

General

Pitch

▶ Zone Settings

Zone Transmit

Effect

Routing

Ins A

Ins B

EQ

Ins Assign

Arpeggio

Common

Individual

Advanced

Motion Seq

Common

Lane

Mod / Control

Part LFO

Control Assign

Receive SW

Element

Osc / Tune

Pitch EG

Filter

Type

Filter EG

Scale

Amplitude

Level / Pan

Amp EG

Scale

Element LFO

Element EQ

All Element

Osc

Balance

Copy or Exchange Elements

Bank Select (Transmit Bank Select)

Determines whether Bank Select MSB/LSB messages are transmitted to the external tone generator or not. This is not available when the Transmit Channel is set to off.

Settings: Off, On

Pgm Change (Transmit Program Change)

Determines whether Program Change messages are transmitted to the external tone generator or not. This is not available when the Transmit Channel is set to off.

Settings: Off, On

Vol/Exp (Transmit Volume/Expression)

Determines whether volume messages are transmitted to the external tone generator or not. This is not available when the Transmit Channel is set to off.

Settings: Off, On

Pan (Transmit Pan)

Determines whether Pan messages are transmitted to the external tone generator or not. This is not available when the Transmit Channel is set to off.

Settings: Off, On

MIDI Bank MSB/LSB (Bank Select MSB/LSB)

Determines the Bank numbers to be transmitted to the external tone generator when selecting the Performance. The Bank consists of MSB and LSB values. This is not available when "Transmit Bank Select" is set to off.

Settings: 000–127

MIDI Pgm Num (Program Change Number)

Determines the Program Change Number to be transmitted to the external tone generator when selecting the Performance. This is not available when the "Transmit Program Change" is set to off.

Settings: 001–128

MIDI Volume

Determines the transmit volume to the external tone generator when selecting the Performance. This is not available when the Transmit Volume/Expression is set to "off".

Settings: 0–127

MIDI Pan

Determines the Pan to be transmitted to the external tone generator when selecting the Performance. This is not available when the Transmit Pan is set to "off."

Settings: L64–C–R63

MIDI Send

By turning this parameter on, MIDI Bank, MIDI Pgm Number, MIDI Volume, or MIDI Pan is transmitted to the external tone generator depending on the setting of the Transmit Switch.

This is not available when the Transmit Channel is set to off or when all of the four Transmit Switches are set to off.

Settings: Off, On

Normal Part (AWM2) Edit

Common

Part Settings

General

Pitch

▶ Zone Settings

Zone Transmit

Effect

Routing

Ins A

Ins B

EQ

Ins Assign

Arpeggio

Common

Individual

Advanced

Motion Seq

Common

Lane

Mod / Control

Part LFO

Control Assign

Receive SW

Element

Osc / Tune

Pitch EG

Filter

Type

Filter EG

Scale

Amplitude

Level / Pan

Amp EG

Scale

Element LFO

Element EQ

All Element

Osc

Balance

Copy or Exchange Elements

Zone Transmit

From the Zone Transmit display you can set how each individual zone affects transmission of various MIDI data, such as Control Change and Program Change messages. When the relevant parameter is set to “on,” playing the selected zone will transmit the corresponding MIDI data.

All settings made in this display are not available when “Transmit Ch” is set to “Off” in the Zone Setting display.

To activate this display, select [UTILITY] → [Settings] → [Advanced], then set “Zone Master” to “ON.” For details, refer to the Owner’s Manual.

Operation

[PERFORMANCE (HOME)] → [EDIT] → Part selection → Element [Common] → [Part Settings] → [Zone Transmit]

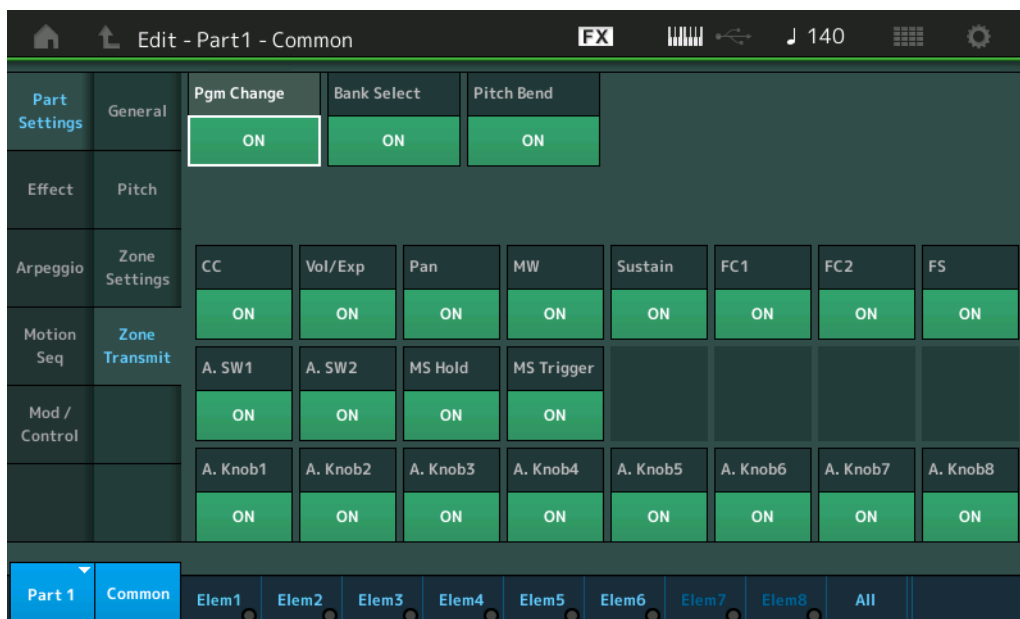

Pgm Change (Transmit Program Change)

Determines whether Program Change messages are transmitted to the external tone generator or not.

Settings: Off, On

Bank Select (Transmit Bank Select)

Determines whether Bank Select MSB/LSB messages are transmitted to the external tone generator or not. This is not available when the Transmit Control Change is set to off.

Settings: Off, On

Pitch Bend (Transmit Pitch Bend)

Determines whether Pitch Bend messages are transmitted to the external tone generator or not.

Settings: Off, On

CC (Transmit Control Change)

Determines whether Control Change messages are transmitted to the external tone generator or not.

Settings: Off, On

Vol/Exp (Transmit Volume/Expression)

Determines whether volume messages are transmitted to the external tone generator or not. This is not available when the Transmit Control Change is set to off.

Settings: Off, On

Pan (Transmit Pan)

Determines whether Pan messages are transmitted to the external tone generator or not. This is not available when the Transmit Control Change is set to off.

Settings: Off, On

Normal Part (AWM2) Edit

Common

Part Settings

General

Pitch

Zone Settings

▶ Zone Transmit

Effect

Routing

Ins A

Ins B

EQ

Ins Assign

Arpeggio

Common

Individual

Advanced

Motion Seq

Common

Lane

Mod / Control

Part LFO

Control Assign

Receive SW

Element

Osc / Tune

Pitch EG

Filter

Type

Filter EG

Scale

Amplitude

Level / Pan

Amp EG

Scale

Element LFO

Element EQ

All Element

Osc

Balance

Copy or Exchange Elements

MW (Transmit Modulation Wheel)

Determines whether MIDI messages generated by using the Modulation Wheel are transmitted to the external tone generator or not.

This is not available when the Transmit Control Change is set to off.

Settings: Off, On

Sustain (Transmit Sustain)

Determines whether Sustain messages are transmitted to the external tone generator or not.

This is not available when the Transmit Control Change is set to off.

Settings: Off, On

FC1/FC2 (Transmit Foot Controller)

Determines whether MIDI messages generated by pressing the optional Foot Controller are transmitted to the external tone generator or not.

This is not available when the Transmit Control Change is set to off.

Settings: Off, On

FS (Transmit Foot Switch)

Determines whether MIDI messages generated by pressing the optional Foot Switch are transmitted to the external tone generator or not.

This is not available when the Transmit Control Change is set to off.

Settings: Off, On

A. SW1/A. SW2 (Transmit Assignable Switch)

Determines whether MIDI messages generated by pressing the [ASSIGN 1] and [ASSIGN 2] buttons are transmitted to the external tone generator or not.

This is not available when the Transmit Control Change is set to off.

Settings: Off, On

MS Hold (Transmit Motion Sequencer Hold)

Determines whether MIDI messages generated by pressing the [MOTION SEQ HOLD] button are transmitted to the external tone generator or not.

This is not available when the Transmit Control Change is set to off.

Settings: Off, On

MS Trigger (Transmit Motion Sequencer Trigger)

Determines whether MIDI messages generated by pressing the [MOTION SEQ TRIGGER] button are transmitted to the external tone generator or not.

This is not available when the Transmit Control Change is set to off.

Settings: Off, On

A.Knob1–8 (Transmit Assignable Knob)

Determines whether MIDI messages generated by using the Assignable Knobs 1–4 (5–8) are transmitted to the external tone generator or not.

This is not available when the Transmit Control Change is set to off.

Settings: Off, On

Normal Part (AWM2) Edit

Common

Part Settings

General

Pitch

Zone Settings

▶ Zone Transmit

Effect

Routing

Ins A

Ins B

EQ

Ins Assign

Arpeggio

Common

Individual

Advanced

Motion Seq

Common

Lane

Mod / Control

Part LFO

Control Assign

Receive SW

Element

Osc / Tune

Pitch EG

Filter

Type

Filter EG

Scale

Amplitude

Level / Pan

Amp EG

Scale

Element LFO

Element EQ

All Element

Osc

Balance

Copy or Exchange Elements

Effect

Routing

From the Routing display you can determine the Effect connections for Parts.

Operation

[PERFORMANCE (HOME)] → [EDIT] → Part selection → Element [Common] → [Effect] → [Routing]

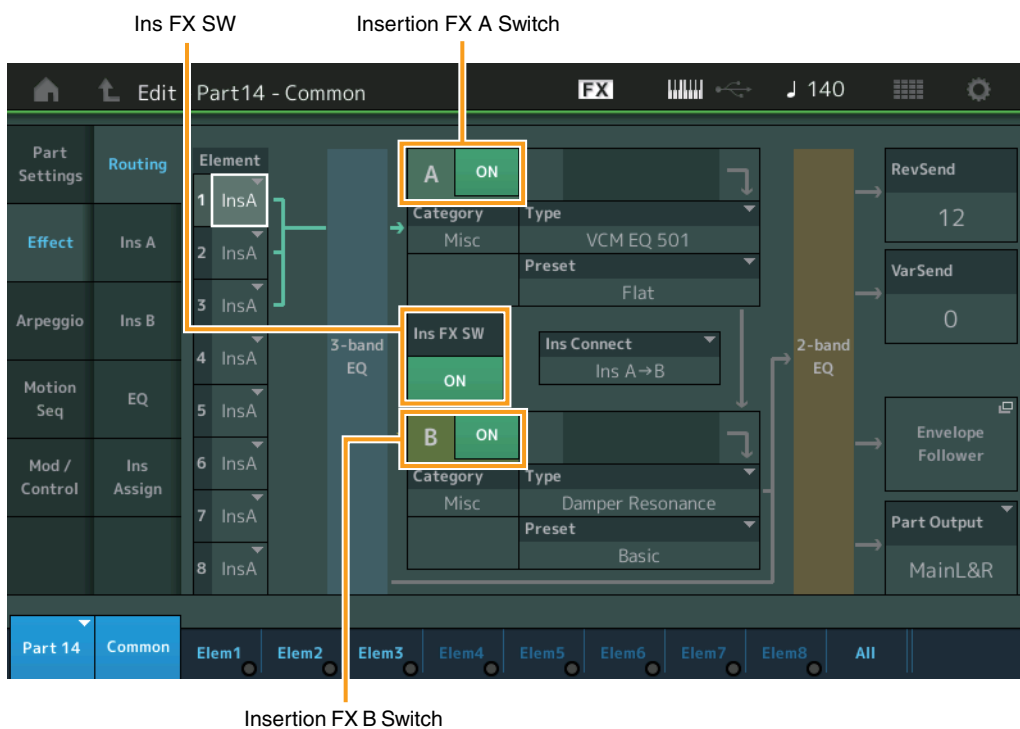

Element 1–8 (Element Connection Switch)

Determines which Insertion Effect (A or B) is used to process each individual Element. The “Thru” setting lets you bypass the Insertion Effects for the specified element.

Settings: Thru, InsA (Insertion Effect A), InsB (Insertion Effect B)

Insertion FX Switch (Insertion Effect Switch)

Determines whether the Insertion Effect A/B is active or not.

For Parts 9-16, the Ins FX SW is shown at the center of the page, and the Insertion effect of the currently being edited Part can be switched ON or OFF.

Settings: Off, On

Category (Effect Category)

Type (Effect Type)

Determines the category and type for the selected Effect.

Settings: For details on the editable Effect categories and types, see the Data List PDF document. Also, for details on the description for each Effect type, see the Synthesizer Parameter Manual PDF document.

Preset

Allows you to call up pre-programmed settings for each Effect type, designed to be used for specific applications and situations. You can change how the sound is affected by the selected pre-programmed settings.

Settings: For a list of all Preset Effects, see the Data List PDF document.

Normal Part (AWM2) Edit

Common

Part Settings

General

Pitch

Zone Settings

Zone Transmit

Effect

Routing

Ins A

Ins B

EQ

Ins Assign

Arpeggio

Common

Individual

Advanced

Motion Seq

Common

Lane

Mod / Control

Part LFO

Control Assign

Receive SW

Element

Osc / Tune

Pitch EG

Filter

Type

Filter EG

Scale

Amplitude

Level / Pan

Amp EG

Scale

Element LFO

Element EQ

All Element

Osc

Balance

Copy or Exchange Elements

Side Chain/Modulator (Side Chain/Modulator Part)

The Side Chain/Modulator uses the output from one track to control an effect in a different track. You can specify the Effect type for activating the feature so that input signals for Parts other than the selected Part or the audio input signal can control the specified Effect. This may not be active depending on the particular Effect Type.

Here you can determine the Part used for the Side Chain/Modulator.

This is not available when you select the same Part or "Master" as the Modulator Part.

Settings: Part 1–16, A/D, Master, Off

Ins Connect (Insertion Connection Type)

Determines the effect routing for Insertion Effects A and B. The setting changes are shown on the diagram in the display, giving you a clear picture of how the signal is routed. For details, see the section "Effect connection" (page 20) of the "Basic Structure."

Settings: Parallel, Ins A→B, Ins B→A

Rev Send (Reverb Send)

Determines the Send level of the signal sent from Insertion Effect A/B (or the bypassed signal) to the Reverb effect. This is available only when "Part Output" is set to "MainL&R."

Settings: 0–127

Var Send (Variation Send)

Determines the Send level of the signal sent from Insertion Effect A/B (or the bypassed signal) to the Variation effect. This is available only when "Part Output" is set to "MainL&R."

Settings: 0–127

Part Output (Part Output Select)

Determines the specific audio output.

Settings: MainL&R, USB1&2...USB7&8, USB1...USB8, Off

MainL&R: Outputs in stereo (two channels) to the OUTPUT [L/MONO]/[R] jacks.

USB1&2...USB7&8: Outputs in stereo (Channels 1&2...7&8) to the [USB TO HOST] terminal.

USB1...USB8: Outputs in mono (Channels 1...8) to the [USB TO HOST] terminal.

Off: No audio signal for the Part is output.

Envelope Follower

Calls up the Envelope Follower setting display. For details on the Envelope Follower, see the "Envelope Follower Block" (page 21) in the "Basic Structure."

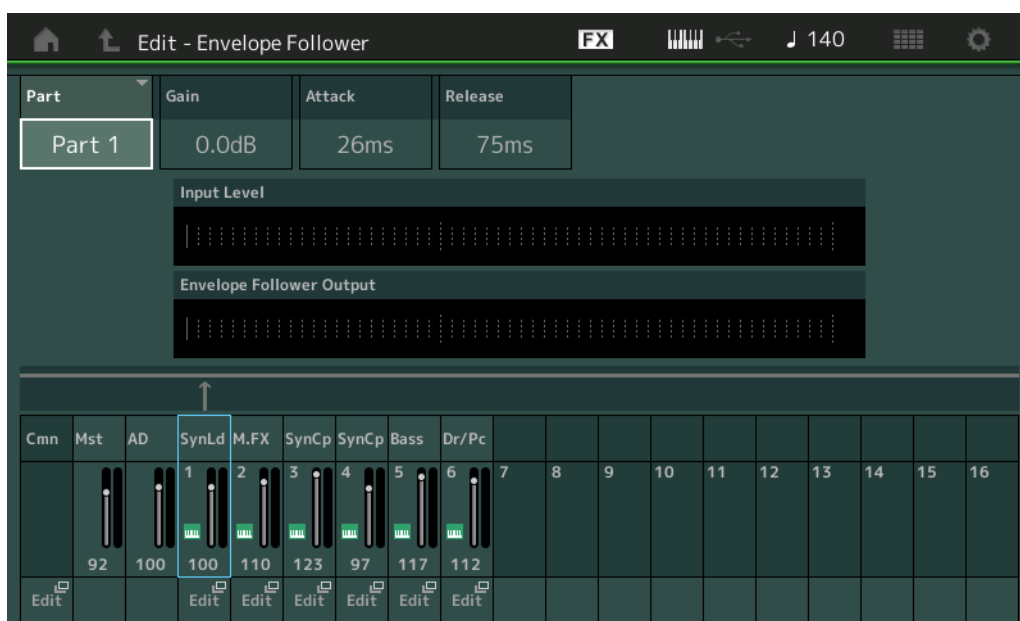

Part (Input Source)

Displays the Part as "Input Source" for the selected Envelope Follower.

Settings: Master, AD, Part 1–Part 16

Normal Part (AWM2) Edit

Common

Part Settings

General

Pitch

Zone Settings

Zone Transmit

Effect

Routing

Ins A

Ins B

EQ

Ins Assign

Arpeggio

Common

Individual

Advanced

Motion Seq

Common

Lane

Mod / Control

Part LFO

Control Assign

Receive SW

Element

Osc / Tune

Pitch EG

Filter

Type

Filter EG

Scale

Amplitude

Level / Pan

Amp EG

Scale

Element LFO

Element EQ

All Element

Osc

Balance

Copy or Exchange Elements

Gain (Envelope Follower Gain)

Determines the Input gain of the Input Source set in “Part.”

Settings: -24dB – 0dB – +24dB

Attack (Envelope Follower Attack)

Determines the attack time of the Envelope Follower.

Settings: 1ms–40ms

Release (Envelope Follower Release)

Determines the release time of the Envelope Follower.

Settings: 10ms–680ms

Input Level

Indicates the Input Level of the signal from the Input Source set in “Part.”

Envelope Follower Output

Indicates the Output Level of the Envelope Follower.

Edit

Calls up the Control Assign display for the Destination Part.

Ins A (Insertion Effect A) Ins B (Insertion Effect B)

From the Insertion Effect A/Insertion Effect B display you can set parameters related to Insertion Effect.

Operation

[PERFORMANCE (HOME)] → [EDIT] → Part selection → Element [Common] → [Effect] → [Ins A] / [Ins B]

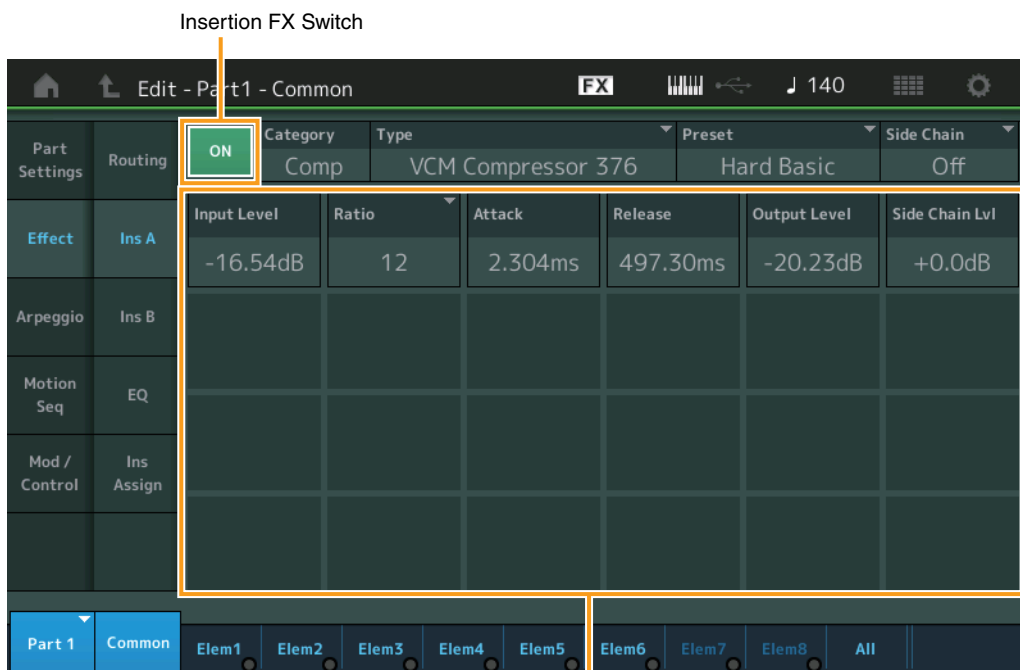

Effect Parameter

Insertion FX Switch (Insertion Effect Switch)

Determines whether the selected Insertion Effect is active or not.

Settings: Off, On

Normal Part (AWM2) Edit

Common

Part Settings

General

Pitch

Zone Settings

Zone Transmit

Effect

▶ Routing

▶ Ins A

▶ Ins B

EQ

Ins Assign

Arpeggio

Common

Individual

Advanced

Motion Seq

Common

Lane

Mod / Control

Part LFO

Control Assign

Receive SW

Element

Osc / Tune

Pitch EG

Filter

Type

Filter EG

Scale

Amplitude

Level / Pan

Amp EG

Scale

Element LFO

Element EQ

All Element

Osc

Balance

 Copy or Exchange
Elements

Category (Effect Category)

Type (Effect Type)

Determines the category and type for the selected Insertion Effect.

Settings: For details on the editable Effect categories and types, see the Data List PDF document. Also, for details on the description for each Effect type, see the Synthesizer Parameter Manual PDF document.

Preset

Allows you to call up pre-programmed settings for each Effect type, designed to be used for specific applications and situations. You can change how the sound is affected by the selected pre-programmed settings.

Settings: For a list of all Preset Effect types, see the Data List PDF document.

Side Chain/Modulator (Side Chain/Modulator Part)

The Side Chain/Modulator uses the output from one track to control an effect in a different track. You can specify the Effect type for activating the feature so that input signals for Parts other than the selected Part or the audio input signal can control the specified Effect. This may not be active depending on the particular Effect Type.

Here you can determine the Part used for the Side Chain/Modulator.

This is not available when you select the same Part or "Master" as the Modulator Part.

Settings: Part 1–16, A/D, Master, Off

Effect Parameter

Active Effect parameters differ depending on the selected Effect Types. For details on the editable Effect parameters, see the Data List PDF document. Also, for details on the description for each Effect parameter, see the Synthesizer Parameter Manual PDF document.

EQ (Part Equalizer)

From the Part Equalizer display you can set parameters related to Part EQ.

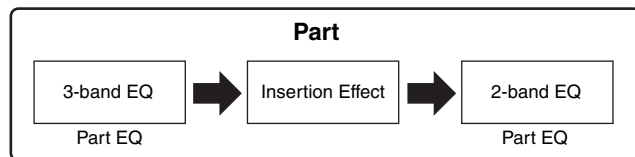

Operation

[PERFORMANCE (HOME)] → [EDIT] → Part selection → Element [Common] → [Effect] → [EQ]

Normal Part (AWM2) Edit

Common

Part Settings

General

Pitch

Zone Settings

Zone Transmit

Effect

Routing

▶ Ins A

▶ Ins B

▶ EQ

Ins Assign

Arpeggio

Common

Individual

Advanced

Motion Seq

Common

Lane

Mod / Control

Part LFO

Control Assign

Receive SW

Element

Osc / Tune

Pitch EG

Filter

Type

Filter EG

Scale

Amplitude

Level / Pan

Amp EG

Scale

Element LFO

Element EQ

All Element

Osc

Balance

Copy or Exchange Elements

Normal Part (AWM2)

Drum Part

Normal Part (FM-X)

Common/Audio

3-band EQ / 2-band EQ (3-band EQ/2-band EQ Switch)

Switches displays between 3-band EQ and 2-band EQ.

Settings: 3-band EQ, 2-band EQ

■ When “3-band EQ” is selected

From this display you can make 3-band EQ settings.

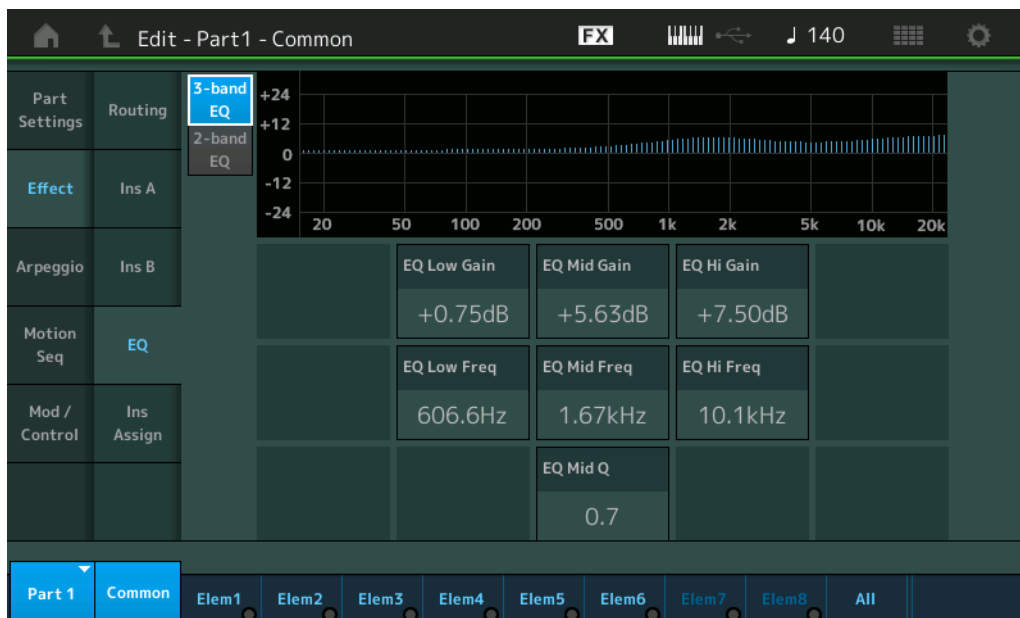

EQ Low Gain (3-band EQ Low Gain)

Determines the level gain of the Low band.

Settings: -12dB – +12dB

EQ Mid Gain (3-band EQ Middle Gain)

Determines the level gain of the Mid band.

Settings: -12dB – +12dB

EQ Hi Gain (3-band EQ High Gain)

Determines the level gain of the High band.

Settings: -12dB – +12dB

EQ Low Freq (3-band EQ Low Frequency)

Determines the frequency for the Low band.

Settings: 50.1Hz–2.00kHz

EQ Mid Freq (3-band EQ Middle Frequency)

Determines the frequency for the Mid band.

Settings: 139.7Hz–10.1kHz

EQ Hi Freq (3-band EQ High Frequency)

Determines the frequency for the High band.

Settings: 503.8Hz–14.0kHz

EQ Mid Q (3-band EQ Middle Q)

Determines the EQ bandwidth of the Mid band.

Settings: 0.7–10.3

Normal Part (AWM2) Edit

Common

Part Settings

General

Pitch

Zone Settings

Zone Transmit

Effect

Routing

Ins A

Ins B

EQ

Ins Assign

Arpeggio

Common

Individual

Advanced

Motion Seq

Common

Lane

Mod / Control

Part LFO

Control Assign

Receive SW

Element

Osc / Tune

Pitch EG

Filter

Type

Filter EG

Scale

Amplitude

Level / Pan

Amp EG

Scale

Element LFO

Element EQ

All Element

Osc

Balance

Copy or Exchange
Elements

Normal Part (AWM2)

Drum Part

Normal Part (FM-X)

Common/Audio

■ When “2-band EQ” is selected

From this display you can make 2-band EQ settings.

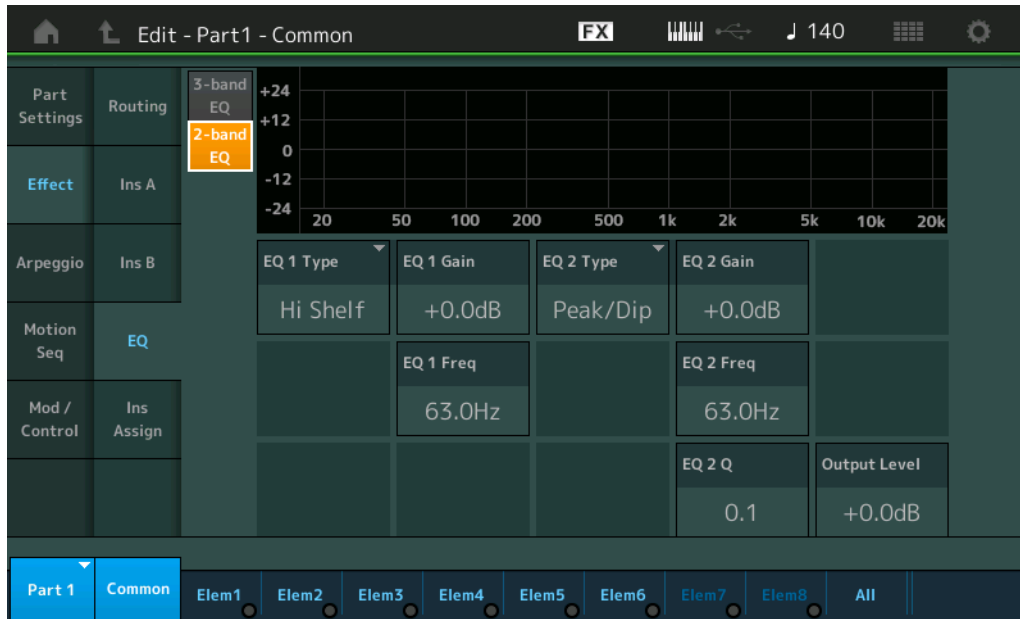

EQ1 Type (2-band EQ1 Type)/EQ2 Type (2-band EQ2 Type)

Determines the Equalizer Type.

Settings: Thru, LPF, HPF, Low Shelf, Hi Shelf, Peak/Dip

Thru: This setting bypasses the equalizers leaving the entire signal unaffected.

LPF/HPF: This setting only passes signals below or above the Cutoff Frequency.

Low Shelf/Hi Shelf: This setting attenuates/boosts the signal at frequencies above or below the specified Frequency setting

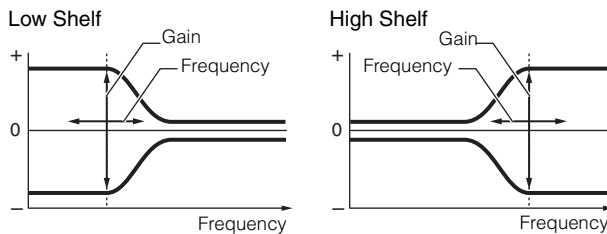

Peak/Dip: This setting attenuates/boosts the signal at the specified Frequency setting.

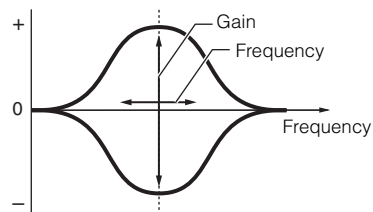

EQ 1 Gain (2-band EQ1 Gain)/EQ 2 Gain (2-band EQ2 Gain)

Determines the level gain of the frequency set in “EQ1 Freq” or “EQ2 Freq.”

This is not active when “EQ Type” is set to “Thru,” “LPF,” or “HPF.”

Settings: -12dB – +12dB

EQ 1 Freq (2-band EQ1 Frequency)/EQ 2 Freq (2-band EQ2 Frequency)

Determines the frequency to be attenuated/boosted.

This is not active when “EQ Type” is set to “Thru.”

Settings: 63Hz–18.0Hz

Normal Part (AWM2) Edit

Common

Part Settings

General

Pitch

Zone Settings

Zone Transmit

Effect

Routing

Ins A

Ins B

EQ

Ins Assign

Arpeggio

Common

Individual

Advanced

Motion Seq

Common

Lane

Mod / Control

Part LFO

Control Assign

Receive SW

Element

Osc / Tune

Pitch EG

Filter

Type

Filter EG

Scale

Amplitude

Level / Pan

Amp EG

Scale

Element LFO

Element EQ

All Element

Osc

Balance

Copy or Exchange Elements

Normal Part (AWM2)

Drum Part

Normal Part (FM-X)

Common/Audio

EQ 1 Q (2-band EQ1 Q)/EQ 2 Q (2-band EQ2 Q)

Determines the EQ bandwidth for the frequency which is set in “EQ 1 Freq/EQ2 Freq.” This is available only when “EQ Type” is set to “Peak/Dip.”

Settings: 0.1–12.0

NOTE For details on EQ structure, see the Synthesizer Parameter Manual PDF document.

Output Level (2-band Output Level)

Determines the Output level of the 2-band EQ.

Settings: -12dB – +12dB

Ins Assign (Insertion Assign)

In the Insertion Assign display, you can set the Insertion Effect for Parts 9–16.

Operation

[PERFORMANCE (HOME)] → [EDIT] → Part selection → Element [Common] → [Effect] → [Ins Assign]

**Active (Active Part)**

Shows the number of Parts with the Ins FX SW set to ON. The number that follows the slash (/) sign is the maximum number of Insertion Effects that can be simultaneously set to ON.

Part9–Part16

Sets the Insertion Effect for Parts 9-16 ON or OFF.

Settings: Off, On

NOTE The Insertion Effect for Parts 1–8 is always ON.

Normal Part (AWM2) Edit

Common**Part Settings**

General

Pitch

Zone Settings

Zone Transmit

Effect

Routing

Ins A

Ins B

▶ **EQ**▶ **Ins Assign****Arpeggio**

Common

Individual

Advanced

Motion Seq

Common

Lane

Mod / Control

Part LFO

Control Assign

Receive SW

Element

Osc / Tune

Pitch EG

Filter

Type

Filter EG

Scale

Amplitude

Level / Pan

Amp EG

Scale

Element LFO**Element EQ****All Element**

Osc

Balance

Copy or Exchange Elements

Arpeggio

Common

From the Common display you can set Arpeggio-related parameters for the Part.

Operation

[PERFORMANCE (HOME)] → [EDIT] → Part selection → Element [Common] → [Arpeggio] → [Common]

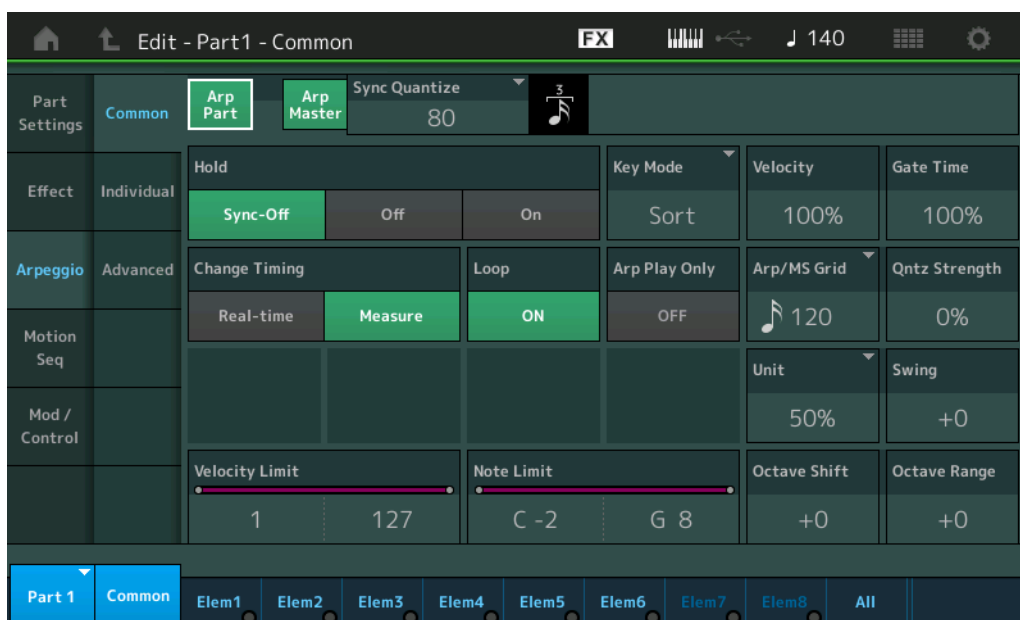

Arp Part (Part Arpeggio Switch)

Determines whether the Arpeggio for the selected Part is active or not.

Settings: Off, On

Arp Master (Arpeggio Master Switch)

Determines whether the Arpeggio for the entire Performance is active or not.

Settings: Off, On

Sync Quantize (Sync Quantize Value)

Determines the actual timing at which the next Arpeggio playback starts when you trigger it while the Arpeggios for Parts are being played back. When set to "off," the next Arpeggio starts as soon as you trigger it. The number shown at right of each value indicates the resolution in clocks.

Settings: Off, 60 (32nd note), 80 (16th note triplet), 120 (16th note), 160 (8th note triplet), 240 (8th note), 320 (1/4 note triplet), 480 (1/4 note)

Hold

Determines whether the Arpeggio continues cycling after the keys are released.

Settings: Sync-off, Off, On

Sync-off: Arpeggio playback continues to run silently, even when you release the keys. Pressing any key turns Arpeggio playback on again, and the Arpeggio is heard from the point in the cycle where playback is resumed.

Off: The Arpeggio plays only while you hold the keys.

On: The Arpeggio cycles automatically, even if you release your fingers from the keys.

Normal Part (AWM2) Edit

Common

Part Settings

General

Pitch

Zone Settings

Zone Transmit

Effect

Routing

Ins A

Ins B

EQ

Ins Assign

Arpeggio

Common

Individual

Advanced

Motion Seq

Common

Lane

Mod / Control

Part LFO

Control Assign

Receive SW

Element

Osc / Tune

Pitch EG

Filter

Type

Filter EG

Scale

Amplitude

Level / Pan

Amp EG

Scale

Element LFO

Element EQ

All Element

Osc

Balance

Copy or Exchange Elements

Key Mode

Determines how the Arpeggio plays back when playing the keyboard.

Settings: Sort, Thru, Direct, Sort+Drct, Thru+Drct

Sort: When you play specific notes (for example, the notes of a chord), the same sequence plays, no matter what order you play the notes.

Thru: When you play specific notes (for example, the notes of a chord), the resulting sequence differs depending on the order of the notes.

Direct: Note events of the Arpeggio sequence do not play; only the notes you play on the keyboard are heard. When the Arpeggio plays back, events such as Pan and Brightness are applied to the sound of your keyboard performance. Use this setting when the Arpeggio types include non-note data or when you set the Arpeggio Category to Control.

Sort+Drct: The Arpeggio plays back according to the Sort setting, and the notes played are also sounded.

Thru+Drct: The Arpeggio plays back according to the Thru setting, and the notes played are also sounded.

Velocity (Velocity Rate)

Determines how much the velocity of Arpeggio playback is offset from the original value. If the resulting Velocity value is 0, it will be set to 1. If the resulting Velocity value is greater than 128 it will be set to 127.

Settings: 0%–200%

Gate Time (Gate Time Rate)

Determines how much the Gate Time (length) of the Arpeggio notes is offset from the original value. If the resulting Gate Time value is 0, it will be set to 1.

Settings: 0%–200%

Change Timing

Determines the actual timing at which the Arpeggio type is switched when you select another type during Arpeggio playback. When set to “Real-time,” the Arpeggio type is switched immediately. When set to “Measure,” the Arpeggio type is switched at the top of the next measure.

Settings: Real-time, Measure

Loop

Determines whether the Arpeggio plays through a single time or continuously, while notes are held.

Settings: Off, On

Arp Play Only (Arpeggio Play Only)

Determines whether or not the current Part plays only the note events of the Arpeggio playback. When this parameter is set to on, only the note events of the Arpeggio playback affect the tone generator block.

Settings: Off, On

Arp/MS Grid (Arpeggio/Motion Sequencer Grid)

Determines the type of note that serves as the basis for the Quantize or Swing. The parameter value is displayed in clocks.

For Motion Sequencer, this parameter value is one step length.

Settings: 60 (32nd note), 80 (16th note triplet), 120 (16th note), 160 (8th note triplet), 240 (8th note), 320 (1/4 note triplet), 480 (1/4 note)

Qntz Strength (Quantize Strength)

This parameter sets the “strength” by which note events are pulled toward the quantize beat set in “Arp/MS Grid.” A setting of 100% produces exact timing set in “Arp/MS Grid.” A setting of 0% results in no quantization.

Settings: 0%–100%

Unit (Part Unit Multiply)

Adjusts the Arpeggio playback time. By using this parameter, you can create a different Arpeggio from the original one.

Settings: 50%, 66%, 75%, 100%, 133%, 150%, 200%, 266%, 300%, 400%, Common

200%: The playback time will be doubled and the tempo is halved.

100%: The normal playback time.

50%: The playback time will be halved and the tempo doubled.

Common: The value set in the Unit Multiply common to the all Parts will be applied.

Normal Part (AWM2) Edit

Common

Part Settings

General

Pitch

Zone Settings

Zone Transmit

Effect

Routing

Ins A

Ins B

EQ

Ins Assign

Arpeggio

▶ Common

Individual

Advanced

Motion Seq

Common

Lane

Mod / Control

Part LFO

Control Assign

Receive SW

Element

Osc / Tune

Pitch EG

Filter

Type

Filter EG

Scale

Amplitude

Level / Pan

Amp EG

Scale

Element LFO

Element EQ

All Element

Osc

Balance

Copy or Exchange Elements

Swing

Delays notes on even-numbered beats (backbeats) to produce a swing feel.

- +1 and higher: Delay the Arpeggio notes.
- -1 and lower: Advance the Arpeggio notes.
- 0: Exact timing as set by “Arpeggio/Motion Sequencer Grid” Value, resulting in no swing.

Judicious use of this setting lets you create swing rhythms and triplet feels, such as shuffle and bounce.

Settings: -120 – +120

Velocity Limit (Arpeggio Velocity Limit)

Determines the minimum and maximum Velocity values in which the Arpeggio responds. Each Arpeggio will only sound for notes played within its specified velocity range. If you first specify the maximum value and then the minimum value, for example “93 to 34,” then the Velocity range covers both “1 to 34” and “93 to 127.”

Settings: 1–127

Note Limit (Arpeggio Note Limit)

Determines the lowest and highest notes in the Arpeggio’s note range. Each Arpeggio will only sound for notes played within its specified range. If you first specify the highest note and then the lowest note, for example “C5 to C4,” then the note range covers both “C-2 to C4” and “C5 to G8.”

Settings: C -2 – G8

Octave Shift (Arpeggio Output Octave Shift)

Shifts the pitch of the Arpeggio up or down in octaves.

Settings: -10 – +0 – +10

Octave Range (Arpeggio Octave Range)

Specifies the maximum Arpeggio range in octaves.

Settings: -3 – +0 – +3

Normal Part (AWM2) Edit

Common

Part Settings

General

Pitch

Zone Settings

Zone Transmit

Effect

Routing

Ins A

Ins B

EQ

Ins Assign

Arpeggio

▶ Common

Individual

Advanced

Motion Seq

Common

Lane

Mod / Control

Part LFO

Control Assign

Receive SW

Element

Osc / Tune

Pitch EG

Filter

Type

Filter EG

Scale

Amplitude

Level / Pan

Amp EG

Scale

Element LFO

Element EQ

All Element

Osc

Balance

Copy or Exchange
Elements

Individual

From the Individual display you can set parameters corresponding to Arpeggio Selects 1–8. Touching the Arpeggio Type Setting calls up a menu. In the displayed menu, touch [Search] to call up the Arpeggio Category Search display (page 180) and touch [Number] to determine the Arpeggio Type by specifying the Arpeggio Number.

Operation

[PERFORMANCE (HOME)] → [EDIT] → Part selection → Element [Common] → [Arpeggio] → [Individual]

Arpeggio Type Settings

Arp	Category	Sub	Name	Velocity	Gate Time
1	SynCp	D&B	MA_Breakbeats 2 _N	+0%	+0%
2	SynCp	D&B	MA_Breakbeats 2 _N	+0%	+0%
3	SynCp	D&B	MA_Breakbeats 2 _N	+0%	+0%
4	Ct/Hb	General	Mute 4/4	+0%	+0%
5	Ct/Hb	General	Mute 4/4	+0%	+0%
6	M.FX	D&B	MA_ComplxtrSQ12 _N	+0%	+0%
7	SynLd	House	MA_SynthRiff2-07	+0%	+0%
8	SynLd	Techno	MA_Simple Lead 01	+0%	+0%

Arp Part (Part Arpeggio Switch)

Arp Master (Arpeggio Master Switch)

Sync Quantize (Sync Quantize Value)

Same as in the Common display.

Arp (Arpeggio Select)

Selects the desired Arpeggio stored as Arpeggio Select.

By selecting a type and pressing [SHIFT] + [EDIT], you can copy or exchange Arpeggios. For details, see “Copying or Exchanging Arpeggios” (page 86).

Settings: 1–8

Category (Arpeggio Category)

Indicates the selected Arpeggio Category.

Settings: See the “Arpeggio Category List” on page 11.

Sub (Arpeggio Sub Category)

Indicates the selected Arpeggio Sub Category.

Settings: See the “Arpeggio Sub Category List” on page 11.

Name (Arpeggio Name)

Indicates the selected Arpeggio Name.

Settings: See the Data List PDF document.

Velocity (Velocity Rate)

Determines how much the velocity of Arpeggio playback is offset from the original value. If the resulting Velocity value is 0, it will be set to 1. If the resulting Velocity value is greater than 128 it will be set to 127.

Settings: -100% – +100%

Normal Part (AWM2) Edit

Common

Part Settings

General

Pitch

Zone Settings

Zone Transmit

Effect

Routing

Ins A

Ins B

EQ

Ins Assign

Arpeggio

Common

Individual

Advanced

Motion Seq

Common

Lane

Mod / Control

Part LFO

Control Assign

Receive SW

Element

Osc / Tune

Pitch EG

Filter

Type

Filter EG

Scale

Amplitude

Level / Pan

Amp EG

Scale

Element LFO

Element EQ

All Element

Osc

Balance

Copy or Exchange Elements

Gate Time (Gate Time Rate)

Determines how much the Gate Time (length) of the Arpeggio notes is offset from the original value. If the resulting Gate Time value is 0, it will be set to 1.

Settings: -100% – +100%

■ Copying or Exchanging Arpeggios

You can copy or exchange between Arpeggio types.

Operation

[PERFORMANCE (HOME)] → [EDIT] → Select Part to be copied → [Arpeggio] → [Individual] → [SHIFT] + [EDIT]
or
[PERFORMANCE (HOME)] → [Motion Control] → [Arpeggio] → Select Part to be copied → [SHIFT] + [EDIT]

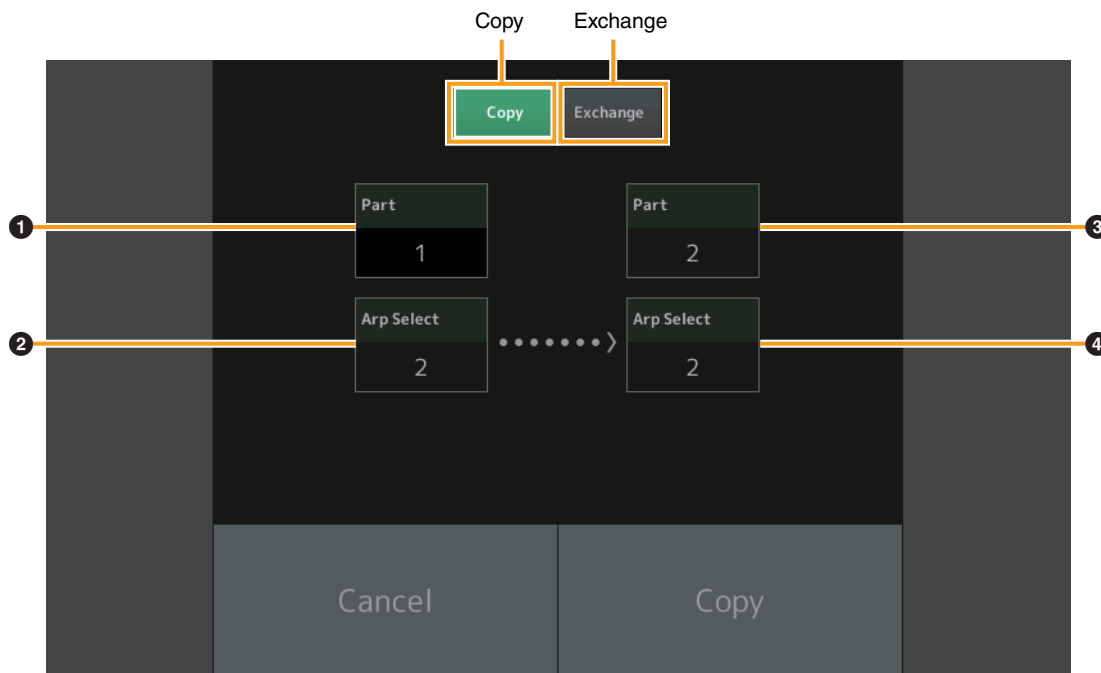

NOTE You can select "All" for Arp Select when copying between different Parts.

Copy

Touching this button activates the Arpeggio Type Copy function.

Exchange

Touching this button activates the Arpeggio Type Exchange function.

❶ Part to be copied (or exchanged)

NOTE The currently selected Part is set automatically and this setting cannot be changed.

❷ Arpeggio Select to be copied (or exchanged)

❸ Copy (or exchange) destination Part

❹ Copy (or exchange) destination Arpeggio Select

Normal Part (AWM2) Edit

Common

Part Settings

General

Pitch

Zone Settings

Zone Transmit

Effect

Routing

Ins A

Ins B

EQ

Ins Assign

Arpeggio

Common

▶ Individual

Advanced

Motion Seq

Common

Lane

Mod / Control

Part LFO

Control Assign

Receive SW

Element

Osc / Tune

Pitch EG

Filter

Type

Filter EG

Scale

Amplitude

Level / Pan

Amp EG

Scale

Element LFO

Element EQ

All Element

Osc

Balance

Copy or Exchange Elements

Advanced

From the Advanced display you can set advanced parameters related to the Arpeggio function.

Operation

[PERFORMANCE (HOME)] → [EDIT] → Part selection → Element [Common] → [Arpeggio] → [Advanced]



Arp Part (Part Arpeggio Switch)

Arp Master (Arpeggio Master Switch)

Sync Quantize (Sync Quantize Value)

Same as in the Common display.

Accent Vel Threshold (Accent Velocity Threshold)

Determines the minimum velocity that will trigger the Accent Phrase.

Accent Phrases are composed of sequence data included in some Arpeggio types, sounding only when you play notes at a velocity higher (stronger) than that specified in the Accent Velocity Threshold parameter. If it is difficult to play at velocities necessary to trigger the Accent Phrase, set the “Accent Vel Threshold” (Accent Velocity Threshold) parameter to a lower value.

NOTE For information on Arpeggio types that use this function, refer to the Data List PDF document.

Settings: off, 1–127

Accent Start Quantize

Determines the start timing of the Accent Phrase when the Velocity specified in Accent Velocity Threshold above is received. When this is set to off, the Accent Phrase starts as soon as the Velocity is received. When this is set to on, the Accent Phrase starts on the beat specified for each Arpeggio type after the Velocity is received.

Settings: off, on

Random SFX

Determines whether Random SFX is active or not.

Some Arpeggio types feature a Random SFX function which will trigger special sounds (such as guitar fret noises) when the note is released.

NOTE For information on Arpeggio types that use this function, refer to the “Arpeggio Type List” in the Data List PDF document.

Settings: off, on

Random SFX Velocity Offset

Determines the offset value by which the Random SFX notes will be shifted from their original velocities.

Settings: -64 – +0 – +63

Normal Part (AWM2) Edit

Common

Part Settings

General

Pitch

Zone Settings

Zone Transmit

Effect

Routing

Ins A

Ins B

EQ

Ins Assign

Arpeggio

Common

Individual

▶ Advanced

Motion Seq

Common

Lane

Mod / Control

Part LFO

Control Assign

Receive SW

Element

Osc / Tune

Pitch EG

Filter

Type

Filter EG

Scale

Amplitude

Level / Pan

Amp EG

Scale

Element LFO

Element EQ

All Element

Osc

Balance

Copy or Exchange Elements

Random SFX Key On Ctrl (Random SFX Key On Control)

When this is set to “on,” the Random SFX sound is played at the velocity generated by the playing of each note. When this is set to “off,” a special Random SFX sound is played at a pre-programmed velocity.

Settings: off, on

Velocity Mode

Adjusts the velocity of the Arpeggio notes.

Settings: Original, Thru

Original: The Arpeggio plays back at the Velocity set for the Arpeggio Type.

Thru: The Arpeggio plays back according to the Velocity of your playing.

Trigger Mode

When this is set to “Gate,” pressing the note starts Arpeggio playback and releasing the note stops it.

When this is set to “Toggle,” pressing the note starts/stops Arpeggio playback and releasing the note does not affect Arpeggio playback.

Settings: Gate, Toggle

Motion Seq (Motion Sequencer)

Common

From the Common display you can set the parameters related to Motion Sequencer for the Part.

Operation

[PERFORMANCE (HOME)] → [EDIT] → Part selection → Element [Common] → [Motion Seq] → [Common]



Common Clock Swing (Common Swing)

Determines the Swing of the Arpeggio/Motion Sequencer for the entire Performance. This is the offset value for the Swing of the Arpeggio/Motion Sequencer for each Part.

Settings: -120 – +120

Common Clock Unit (Common Unit Multiply)

Adjusts the Arpeggio/Motion Sequencer playback time for the entire Performance.

This parameter is applied to the Part when the Unit Multiply parameter for Arpeggio/Motion Sequencer of the Part is set to “Common.”

By using this parameter, you can create a different Arpeggio/Motion Sequencer type from the original one.

Settings: 50%–400%

200%: The playback time will be doubled and the tempo is halved.

100%: The normal playback time.

50%: The playback time will be halved and the tempo doubled.

Normal Part (AWM2) Edit

Common

Part Settings

General

Pitch

Zone Settings

Zone Transmit

Effect

Routing

Ins A

Ins B

EQ

Ins Assign

Arpeggio

Common

Individual

▶ Advanced

▶ Motion Seq

▶ Common

Lane

Mod / Control

Part LFO

Control Assign

Receive SW

Element

Osc / Tune

Pitch EG

Filter

Type

Filter EG

Scale

Amplitude

Level / Pan

Amp EG

Scale

Element LFO

Element EQ

All Element

Osc

Balance

Copy or Exchange Elements

Common Arpeggio Gate Time (Common Arpeggio Gate Time)

Determines the Gate Time Rate (length) of the Arpeggio for the entire Performance. This is the offset value for the Gate Time Rate of the Arpeggio for each Part.

Settings: -100% – +100%

Common Arpeggio Velocity (Common Arpeggio Velocity Rate)

Determines the Velocity Rate of the Arpeggio for the entire Performance. This is the offset value for the Velocity Rate of the Arpeggio for each Part.

Settings: -100% – +100%

Common Motion Seq Amplitude (Common Motion Sequencer Amplitude)

Determines the Amplitude of the Motion Sequencer for the entire Performance. “Amplitude” determines how the entire Motion Sequence changes.

This is the offset value for the Part Motion Seq Amplitude, which is also the offset value for the Lane Amplitude. This results in that both of the Common and Part MS Amplitudes offset the Amplitude setting in the Lane (only when “MS FX” is set to on for the Lane).

Settings: -64 – +63

Common Motion Seq Shape (Common Motion Sequencer Pulse Shape)

Determines the Pulse Shape of the Motion Sequencer for the entire Performance. This changes the step curve shape of the sequence.

This is the offset value for the Part Motion Seq Pulse Shape, which is also the offset value for the Lane Pulse Shape. This results in that both of the Common and Part MS Pulse Shapes offset the Pulse Shape setting for the parameter in the Lane (only when “MS FX” is set to on for the Lane and “Control” is set to on for the parameter).

Settings: -100 – +100

Common Motion Seq Smooth (Common Motion Sequencer Smoothness)

Determines the Smoothness of the Motion Sequencer for the entire Performance. “Smoothness” is the degree to which the time of the Motion Sequence is smoothly changed.

This is the offset value for the Part Motion Seq Smoothness, which is also the offset value for the Lane Smoothness. This results in that both of the Common and Part MS Smoothnesses offset the Smoothness setting for the parameter in the Lane (only when “MS FX” is set to on for the Lane).

Settings: -64 – +63

Common Motion Seq Random (Common Motion Sequencer Random)

Determines the Random of the Motion Sequencer for the entire Performance. “Random” is the degree to which the Step Value of the Sequence is randomly changed.

This is the offset value for the Part Motion Seq Random when “MS FX” is set to on for the Lane.

Settings: -64 – +63

Part Clock Swing (Clock Swing)

Determines the Swing of the Arpeggio/Motion Sequencer for the selected Part. This parameter delays notes on even-numbered beats (backbeats) to produce a swing feel.

- +1 and higher: Delay the Arpeggio notes.
- -1 and lower: Advance the Arpeggio notes.
- 0: Exact timing as set by “Arpeggio/Motion Sequencer Grid” Value, resulting in no swing.

Judicious use of this setting lets you create swing rhythms and triplet feels, such as shuffle and bounce.

Settings: -120 – +120

Part Clock Unit (Part Unit Multiply)

This adjusts the Arpeggio/Motion Sequencer playback time for the selected Part.

Settings: 50%–400%, Common

200%: The playback time will be doubled and the tempo is halved.

100%: The normal playback time.

50%: The playback time will be halved and the tempo doubled.

Common: The value set in the Unit Multiply common to the all Parts will be applied.

Normal Part (AWM2) Edit

Common

Part Settings

General

Pitch

Zone Settings

Zone Transmit

Effect

Routing

Ins A

Ins B

EQ

Ins Assign

Arpeggio

Common

Individual

Advanced

Motion Seq

▶ Common

Lane

Mod / Control

Part LFO

Control Assign

Receive SW

Element

Osc / Tune

Pitch EG

Filter

Type

Filter EG

Scale

Amplitude

Level / Pan

Amp EG

Scale

Element LFO

Element EQ

All Element

Osc

Balance

Copy or Exchange Elements

Part Arpeggio Gate Time (Part Arpeggio Gate Time)

Determines how much the Gate Time (length) of the Arpeggio notes is offset from the original value. This is the offset value for the Gate Time Rate (page 86) of each Arpeggio Select setting.

Settings: 0%–200%

Part Arpeggio Velocity (Part Arpeggio Velocity Rate)

Determines how much the velocity of Arpeggio playback is offset from the original value. This is the offset value for the Velocity Rate (page 85) of each Arpeggio Select setting.

Settings: 0%–200%

Part Motion Seq Amplitude (Part Motion Sequencer Amplitude)

Determines the Amplitude of the Motion Sequencer for the selected Part.

This is the offset value for the Lane Motion Seq Amplitude (page 93) when “MS FX” is set to on for the Lane.

Settings: -64 – +63

Part Motion Seq Shape (Part Motion Sequencer Pulse Shape)

Determines the Pulse Shape of the Motion Sequencer for the selected Part.

This is the offset value for the Lane Motion Seq “Step Curve Parameter” (page 94) when “MS FX” is set to on for the Lane and “Control” is set to on for the parameter.

Settings: -100 – +100

Part Motion Seq Smooth (Part Motion Sequencer Smoothness)

Determines the Smoothness of the Motion Sequencer for the selected Part.

This is the offset value for the Lane Motion Seq Smoothness (page 93) when “MS FX” is set to on for the Lane.

Settings: -64 – +63

Part Motion Seq Random (Part Motion Sequencer Random)

Determines the Random of the Motion Sequencer for the selected Part. “Random” is the degree to which the Step Value of the Sequence is randomly changed.

Settings: 0–127

Arp/MS Grid (Arpeggio/Motion Sequencer Grid)

Determines the type of note that serves as the basis for the Quantize or Swing. The parameter value is displayed in clocks.

For Motion Sequencer, this parameter value is one step length.

Settings: 60 (32nd note), 80 (16th note triplet), 120 (16th note), 160 (8th note triplet), 240 (8th note), 320 (1/4 note triplet), 480 (1/4 note)

Normal Part (AWM2) Edit

Common

Part Settings

General

Pitch

Zone Settings

Zone Transmit

Effect

Routing

Ins A

Ins B

EQ

Ins Assign

Arpeggio

Common

Individual

Advanced

Motion Seq

▶ Common

Lane

Mod / Control

Part LFO

Control Assign

Receive SW

Element

Osc / Tune

Pitch EG

Filter

Type

Filter EG

Scale

Amplitude

Level / Pan

Amp EG

Scale

Element LFO

Element EQ

All Element

Osc

Balance

Copy or Exchange Elements

Lane

From the Lane display you can set parameters for each Lane of the Motion Sequencer.

Operation

[PERFORMANCE (HOME)] → [EDIT] → Part selection → Element [Common] → [Motion Seq] → [Lane]

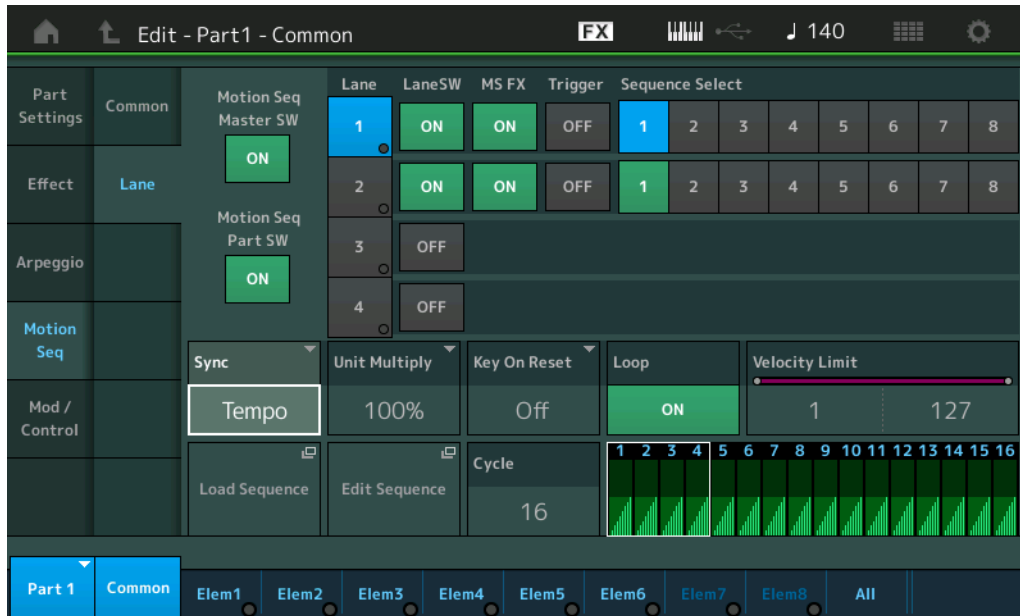

Motion Seq Master SW (Motion Sequencer Master Switch)

Determines whether the Motion Sequencer for the entire Performance is active or not.

Settings: Off, On

Motion Seq Part SW (Motion Sequencer Part Switch)

Determines whether the Motion Sequencer for the selected Part is active or not.

Settings: Off, On

Lane SW (Lane Switch)

Determines whether each Lane is active or not. Up to four Lanes of Motion Sequencer can be used for one Part and up to eight Lanes can be used at the same time for the entire Performance. When this is set to off, parameters related to the corresponding Lane will not be displayed.

Settings: Off, On

MS FX (Lane Motion Sequencer FX Receive)

Determines whether or not the selected Lane is affected by Knob operations when the “ARP/MS” is selected with the Knob Function [TONE]/[EG/FX]/[EQ]/[ARP/MS] button.

Settings: Off, On

Trigger (Lane Motion Sequencer Trigger Receive)

Determines whether or not the selected Lane receives the signal generated by [MOTION SEQ TRIGGER] button. When this is set to on, the Motion Sequence will begin whenever you press the [MOTION SEQ TRIGGER] button.

Settings: Off, On

Sequence Select (Lane Motion Sequence Select)

Selects the desired Motion Sequence.

By selecting a type and pressing [SHIFT] + [EDIT], you can copy or exchange Motion Sequences. For details, see “Copying or Exchanging Motion Sequences” (page 95).

Settings: 1–8

Normal Part (AWM2) Edit

Common

Part Settings

General

Pitch

Zone Settings

Zone Transmit

Effect

Routing

Ins A

Ins B

EQ

Ins Assign

Arpeggio

Common

Individual

Advanced

Motion Seq

Common

Lane

Mod / Control

Part LFO

Control Assign

Receive SW

Element

Osc / Tune

Pitch EG

Filter

Type

Filter EG

Scale

Amplitude

Level / Pan

Amp EG

Scale

Element LFO

Element EQ

All Element

Osc

Balance

Copy or Exchange Elements

Sync (Lane Motion Sequencer Sync)

Determines if the playback of the Motion Sequence applied to the Destination (set in the Control Assign display (page 100)) is synchronized to the Tempo, Beat, or Arpeggio of the Performance.

Settings: Off, Tempo, Beat, Arp, Lane 1 (when Lane 2–4 is selected)

Off: Lane Motion Sequencer plays back according to its own clock and is not synchronized to an external clock.

Tempo: Lane Motion Sequencer is synchronized with the Performance tempo.

Beat: Lane Motion Sequencer is synchronized with the beat.

Arp: Lane Motion Sequencer is synchronized with the 1st beat of the measure of the currently playing Arpeggio.

Lane 1: Lane Motion Sequencer is synchronized with the Lane 1.

Speed (Lane Motion Sequencer Speed)

Determines the playback speed of the Motion Sequence.

This is available only when the “Lane Motion Sequencer Sync” is set to “Off.”

Settings: 0–127

Unit Multiply (Lane Motion Sequencer Unit Multiply)

Adjusts the Motion Sequencer playback time for the selected Lane.

This is available when the Lane Motion Sequencer Sync parameter is set to something other than “Off” and “Lane 1.”

Settings: 50%–6400%, Common, Arp

200%: The playback time will be doubled and the tempo is halved.

100%: The normal playback time.

50%: The playback time will be halved and the tempo doubled.

Common: The value set in the Unit Multiply common to the all Parts will be applied.

Arp: The value set in the Arpeggio Unit Multiply for the selected Part will be applied.

Key On Reset (Lane Motion Sequencer Key On Reset)

Determines whether or not the playback of the Motion Sequence is stopped when you play the keyboard. This parameter is active when the Lane Motion Sequencer Sync parameter is set to something other than “Arp” and “Lane 1.”

Also this parameter is not available when “Trigger” is set to “On.”

Settings: Off, Each-On, 1st-On

Each-On: The Sequence resets with each note you play and starts the Sequence from the beginning.

1st-On: The Sequence resets with each note you play and starts the Sequencer from the beginning. If you play a second note while the first is being held, the Sequence continues cycling according to the same phase as triggered by the first note—in other words, the Sequence only resets if the first note is released before the second is played.

Loop (Lane Motion Sequencer Loop)

Determines whether the Motion Sequence is played only once or repeatedly.

This is available when the Lane Motion Sequencer Sync parameter is set to something other than “Lane 1.”

Settings: Off, On

Velocity Limit (Lane Motion Sequencer Velocity Limit)

Determines the minimum and maximum Velocity values in which the Motion Sequence responds.

This is available when the Lane Motion Sequencer Sync parameter is set to something other than “Lane 1.”

Settings: 1–127

Cycle (Lane Motion Sequencer Cycle)

Selects the desired step length for the Motion Sequence.

Settings: 1–16

Load Sequence

Loads Motion Sequence data in the User Memory. For details about Loading, see “Load” (page 198).

Normal Part (AWM2) Edit

Common

Part Settings

General

Pitch

Zone Settings

Zone Transmit

Effect

Routing

Ins A

Ins B

EQ

Ins Assign

Arpeggio

Common

Individual

Advanced

Motion Seq

Common

Lane

Mod / Control

Part LFO

Control Assign

Receive SW

Element

Osc / Tune

Pitch EG

Filter

Type

Filter EG

Scale

Amplitude

Level / Pan

Amp EG

Scale

Element LFO

Element EQ

All Element

Osc

Balance

Copy or Exchange Elements

Edit Sequence

Calls up the Motion Sequence setting display. You can create a custom Sequence consisting of up to sixteen steps.

Motion Seq Step Value (Lane Motion Sequencer Step Value)

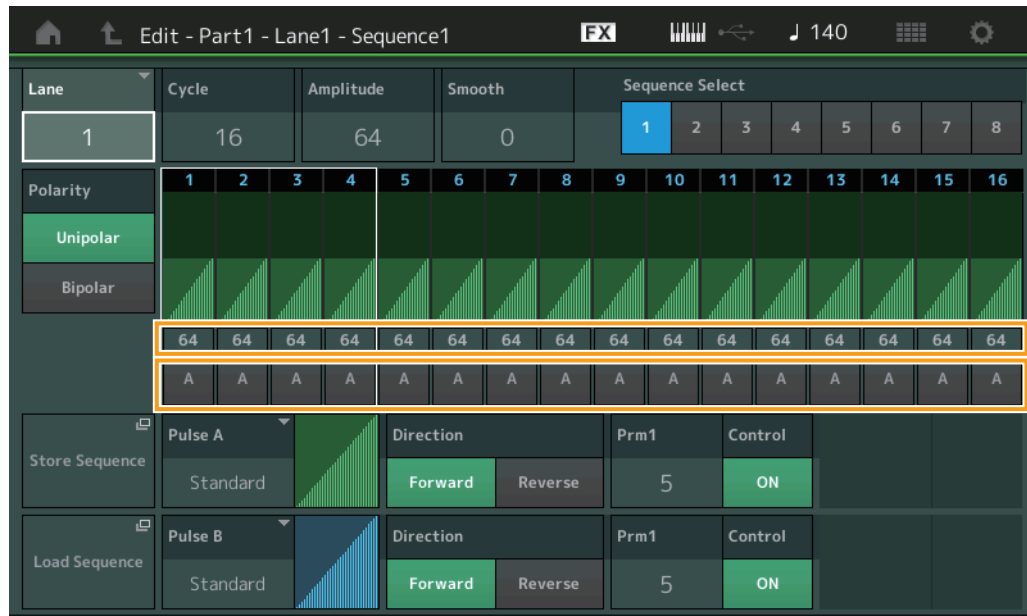

Motion Seq Step Type (Lane Motion Sequencer Step Type)

Lane (Current Select Lane)

Indicates the currently selected Lane. This parameter is not displayed when the corresponding Lane Switch is set to off.

Settings: 1-4

Cycle (Lane Motion Sequencer Cycle)

Selects the desired step length for the Motion Sequence.

Settings: 1-16

Amplitude (Lane Motion Sequencer Amplitude)

Determines how the entire Motion Sequence changes.

Settings: 0-127

Smooth (Lane Motion Sequencer Smoothness)

Determines the smoothness of the time change of the Motion Sequence.

Settings: 0-127

Sequence Select (Lane Motion Sequence Select)

Determines the Motion Sequence Select.

By selecting a type and pressing [SHIFT] + [EDIT], you can copy or exchange Motion Sequences. For details, see "Copying or Exchanging Motion Sequences" (page 95).

Settings: 1-8

Polarity (Lane Motion Sequencer Polarity)

Determines the Sequence Polarity.

Settings: Unipolar, Bipolar

Unipolar: Unipolar changes only in a positive direction from a base parameter value according to the Sequence.

Bipolar: Bipolar changes in both of positive and negative directions from a base parameter value.

Motion Seq Step Value (Lane Motion Sequencer Step Value)

Determines the Step Value for the Motion Sequence. You can control the Step Value 1-4, 5-8, 9-12 or 13-16 by the Control Sliders 1-4 (5-8 / 9-12 / 13-16) depending on the cursor position on the display.

Settings: 0-127

Normal Part (AWM2) Edit

Common

Part Settings

General

Pitch

Zone Settings

Zone Transmit

Effect

Routing

Ins A

Ins B

EQ

Ins Assign

Arpeggio

Common

Individual

Advanced

Motion Seq

Common

Lane

Mod / Control

Part LFO

Control Assign

Receive SW

Element

Osc / Tune

Pitch EG

Filter

Type

Filter EG

Scale

Amplitude

Level / Pan

Amp EG

Scale

Element LFO

Element EQ

All Element

Osc

Balance

Copy or Exchange Elements

Motion Seq Step Type (Lane Motion Sequencer Step Type)

Determines each Step Type of the Motion Sequence. You can switch between the Step Types A and B for the Step 1–8 or 9–16 by the SCENE [1/5]–[4/8] buttons depending on the cursor position on the display.

Settings: A, B

Pulse A / Pulse B (Lane Motion Sequencer Step Curve Type)

Determines the Curve Type of the parameter for each of “Pulse A” and “Pulse B.” “Motion Seq Step Type” described above determines which curve set here is used for each step.

Settings: For Preset Bank: Standard, Sigmoid, Threshold, Bell, Dogleg, FM, AM, M, Discrete Saw, Smooth Saw, Triangle, Square, Trapezoid, Tilt Sine, Bounce, Resonance, Sequence, Hold

For details, see the Synthesizer Parameter Manual PDF document.

For User Bank: User 1–32

When a Library file is read: Curves in Library 1–8

Direction (Lane Motion Sequencer Step Curve Direction)

Determines the Direction of the Step Curve for the Motion Sequence.

Settings: Forward, Reverse

Prm1/Prm2 (Lane Motion Sequencer Step Curve Parameter)

Adjusts the shape of the Step Curve for the Motion Sequence.

This parameter is not available depending on the Curve Type. Also the range of available parameter values differs depending on the Curve Type.

Control (Lane Motion Sequencer Step Curve Shape Control Switch)

Determines whether or not to control the shape of the Step Curve for the Motion Sequence by operating Knobs. This parameter is displayed only when “MS FX” is set to on. Also this parameter is not available depending on the Curve Type.

Settings: Off, On

Store Sequence

Stores the edited Sequence data. For details about storing data, see “Store/Save” ([page 201](#)).

Normal Part (AWM2) Edit

Common

Part Settings

General

Pitch

Zone Settings

Zone Transmit

Effect

Routing

Ins A

Ins B

EQ

Ins Assign

Arpeggio

Common

Individual

Advanced

Motion Seq

Common

▶ Lane

Mod / Control

Part LFO

Control Assign

Receive SW

Element

Osc / Tune

Pitch EG

Filter

Type

Filter EG

Scale

Amplitude

Level / Pan

Amp EG

Scale

Element LFO

Element EQ

All Element

Osc

Balance

Copy or Exchange Elements

■ Copying or Exchanging Motion Sequences

You can copy or exchange between Motion Sequences.

Operation

[PERFORMANCE (HOME)] → [EDIT] → Select Part to be copied → [Motion Seq] → [Lane] → [SHIFT] + [EDIT]
 or
 [PERFORMANCE (HOME)] → [Motion Control] → [Motion Seq] → Select Part to be copied → [SHIFT] + [EDIT]
 or
 [PERFORMANCE (HOME)] → [Motion Control] → [Knob Auto] → [SHIFT] + [EDIT]

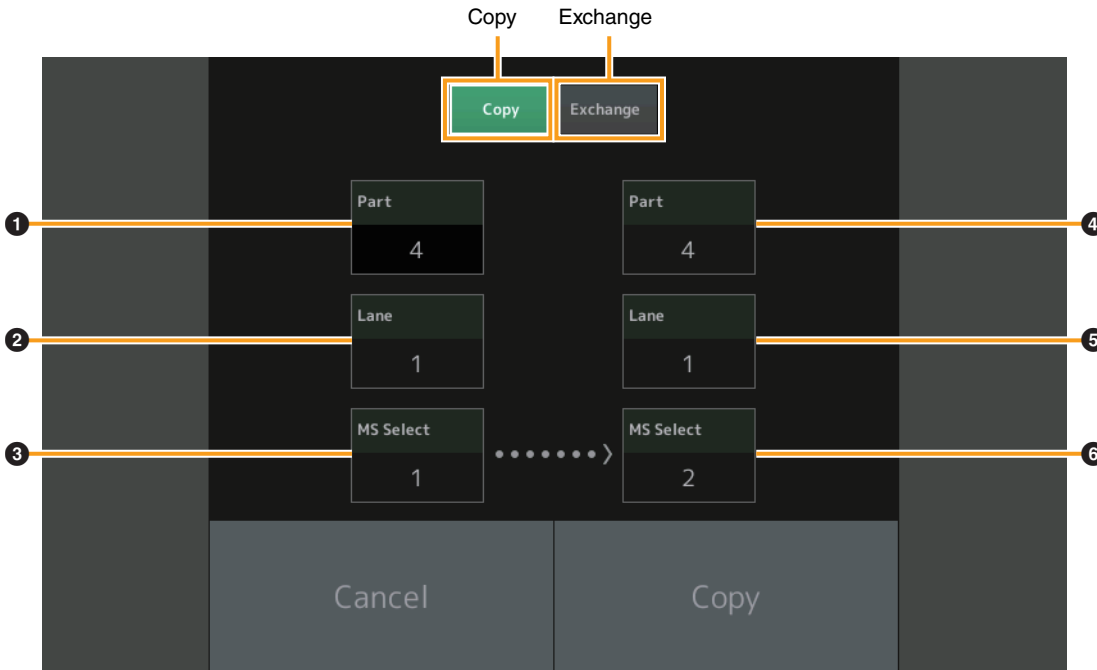

NOTE You can select "All" for "Lane" and "MS Select" when copying between different Parts.

Copy

Touching this button activates the Motion Sequence Copy function.

Exchange

Touching this button activates the Motion Sequence Exchange function.

❶ Part to be copied (or exchanged)

NOTE The currently selected Part is set automatically and this setting cannot be changed.

❷ Lane to be copied (or exchanged)

❸ Motion Sequence Select to be copied (or exchanged)

❹ Copy (or exchange) destination Part

❺ Copy (or exchange) destination Lane

❻ Copy (or exchange) destination Motion Sequence Select

Normal Part (AWM2) Edit

Common

Part Settings

General

Pitch

Zone Settings

Zone Transmit

Effect

Routing

Ins A

Ins B

EQ

Ins Assign

Arpeggio

Common

Individual

Advanced

Motion Seq

Common

▶ Lane

Mod / Control

Part LFO

Control Assign

Receive SW

Element

Osc / Tune

Pitch EG

Filter

Type

Filter EG

Scale

Amplitude

Level / Pan

Amp EG

Scale

Element LFO

Element EQ

All Element

Osc

Balance

Copy or Exchange Elements

Mod/Control (Modulation/Control)

Part LFO

From the Part LFO display you can set the LFO-related parameters for the Part.

Operation

[PERFORMANCE (HOME)] → [EDIT] → Part selection → Element [Common] → [Mod/Control] → [Part LFO]

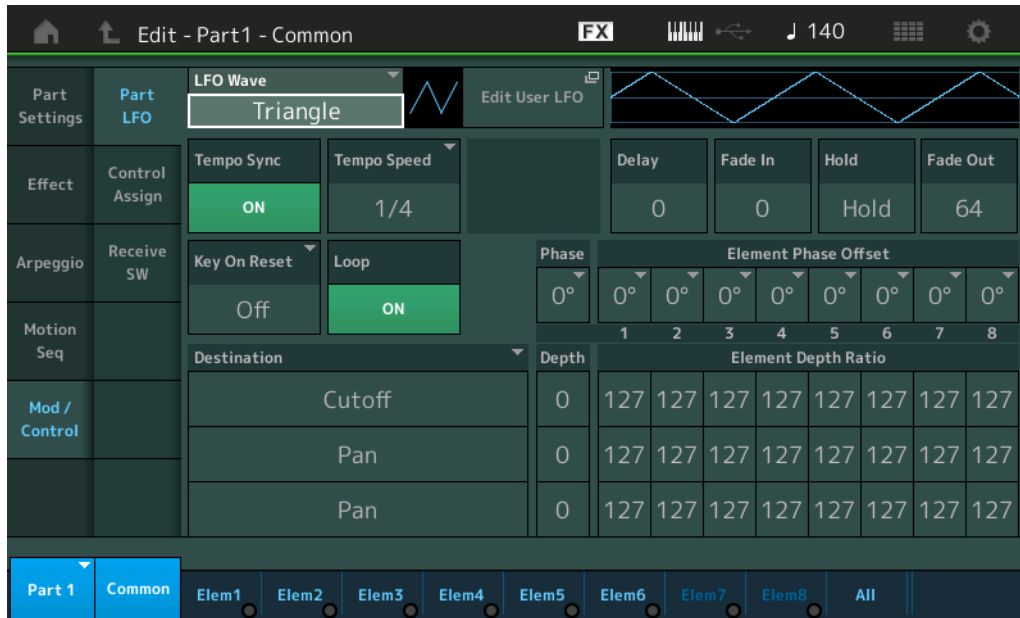

LFO Wave

Selects the LFO waveform.

Settings: Triangle, Triangle+, Saw Up, Saw Down, Squ1/4, Squ1/3, Square, Squ2/3, Squ3/4, Trapezoid, S/H1, S/H2, User

Tempo Sync (LFO Tempo Sync)

Determines whether or not the LFO is synchronized to the tempo of the Arpeggio or Song.

Settings: Off (not synchronized), On (synchronized)

Normal Part (AWM2) Edit

Common

Part Settings

General

Pitch

Zone Settings

Zone Transmit

Effect

Routing

Ins A

Ins B

EQ

Ins Assign

Arpeggio

Common

Individual

Advanced

Motion Seq

Common

Lane

Mod / Control

Part LFO

Control Assign

Receive SW

Element

Osc / Tune

Pitch EG

Filter

Type

Filter EG

Scale

Amplitude

Level / Pan

Amp EG

Scale

Element LFO

Element EQ

All Element

Osc

Balance

Copy or Exchange Elements

Normal Part (AWM2)

Drum Part

Normal Part (FM-X)

Common/Audio

■ When “Tempo Sync” is set to “OFF”

Normal Part (AWM2) Edit

Common

Part Settings

Part LFO

LFO Wave: Triangle

Effect Control Assign

Tempo Sync: OFF

Speed: 32

Random Speed: 0

Delay: 0

Fade In: 0

Hold: Hold

Fade Out: 64

Arpeggio Receive SW

Key On Reset: Off

Loop: ON

Phase: 0°

Element Phase Offset

Element Depth Ratio

Destination: Cutoff

Depth: 0

Element Depth Ratio: 127 127 127 127 127 127 127 127

Pan: 0 127 127 127 127 127 127 127

Pan: 0 127 127 127 127 127 127 127

Part 1 Common

Elem1 Elem2 Elem3 Elem4 Elem5 Elem6 Elem7 Elem8 All

Speed (LFO Speed)

Adjusts the speed (frequency) of LFO variation. This is not available when the Tempo Sync parameter is set to “On.”

Settings: 0–63

Random Speed (LFO Random Speed Depth)

Determines the degree to which the LFO speed changes at random.

Settings: 0–127

■ When “Tempo Sync” is set to “ON”

Normal Part (AWM2) Edit

Common

Part Settings

Part LFO

LFO Wave: Triangle

Effect Control Assign

Tempo Sync: ON

Tempo Speed: 1/4

Delay: 0

Fade In: 0

Hold: Hold

Fade Out: 64

Arpeggio Receive SW

Key On Reset: Off

Loop: ON

Phase: 0°

Element Phase Offset

Element Depth Ratio

Destination: Cutoff

Depth: 0

Element Depth Ratio: 127 127 127 127 127 127 127 127

Pan: 0 127 127 127 127 127 127 127

Pan: 0 127 127 127 127 127 127 127

Part 1 Common

Elem1 Elem2 Elem3 Elem4 Elem5 Elem6 Elem7 Elem8 All

Tempo Speed (LFO Tempo Speed)

This parameter is available only when “Tempo Sync” above has been set to “ON.” It allows you to make detailed note value settings that determine how the LFO pulses in sync with the Arpeggio.

Settings: 1/16, 1/8 Tri. (eighth-note triplets), 1/16 Dot. (dotted sixteenth notes), 1/8, 1/4 Tri. (quarter-note triplets), 1/8 Dot. (dotted eighth notes), 1/4, 1/2 Tri. (half-note triplets), 1/4 Dot. (dotted quarter notes), 1/2, Whole Tri. (whole-note triplets), 1/2 Dot. (dotted half notes), 1/4 x 4 (quarter-note quadruplets; four quarter notes to the beat), 1/4 x 5 (quarter-note quintuplets; five quarter notes to the beat), 1/4 x 6 (quarter-note sextuplets; six quarter notes to the beat), 1/4 x 7 (quarter-note septuplets; seven quarter notes to the beat), 1/4 x 8 (quarter-note octuplets; eight quarter notes to the beat), 1/4 x 16 (sixteen quarter-notes to the beat), 1/4 x 32 (32 quarter notes to the beat), 1/4 x 64 (64 quarter notes to the beat)

Normal Part (AWM2) Edit

Common

Part Settings

General

Pitch

Zone Settings

Zone Transmit

Effect

Routing

Ins A

Ins B

EQ

Ins Assign

Arpeggio

Common

Individual

Advanced

Motion Seq

Common

Lane

Mod / Control

▶ Part LFO

Control Assign

Receive SW

Element

Osc / Tune

Pitch EG

Filter

Type

Filter EG

Scale

Amplitude

Level / Pan

Amp EG

Scale

Element LFO

Element EQ

All Element

Osc

Balance

Copy or Exchange Elements

Delay (LFO Delay Time)

Determines the delay time between the moment you press a key on the keyboard and the moment the LFO comes into effect.

Settings: 0–127

Fade In (LFO Fade In Time)

Determines the amount of time for the LFO effect to fade in (after the “Delay” time has elapsed).

Settings: 0–127

Hold (LFO Hold Time)

Determines the length of time during which the LFO is held at its maximum level.

Settings: 0–126, Hold

Hold: No fade-out

Fade Out (LFO Fade Out Time)

Determines the time over which the LFO effect is faded out (after the “Hold” time has elapsed).

Settings: 0–127

Key On Reset (LFO Key On Reset)

Determines whether or not the LFO is reset each time a note is pressed.

Settings: Off, Each-On, 1st-On

Each-On: The LFO resets with each note you play and starts a waveform at the phase specified by the Phase parameter.

1st-On: The LFO resets with each note you play and starts a waveform at the phase specified by the Phase parameter. If you play a second note while the first is being held, the LFO continues cycling according to the same phase as triggered by the first note—in other words, the LFO only resets if the first note is released before the second is played.

Loop (LFO Loop)

Determines whether the LFO Wave plays through a single time (off) or continuously (on).

Settings: Off, On

Phase (LFO Phase)

Determines the starting phase point for the LFO Wave when it is reset.

Settings: 0°, 90°, 120°, 180°, 240°, 270°

Element Phase Offset (LFO Element Phase Offset)

Determines the offset values of the “Phase” parameter (above) for the respective Elements.

Settings: 0°, 90°, 120°, 180°, 240°, 270°

Destination (LFO Destination)

Determines the functions which will be controlled by the LFO Wave.

Settings: Insertion Effect A Parameter 1–24, Insertion Effect B Parameter 1–24, Level, Pitch, Cutoff, Resonance, Pan, E.LFO Speed

Depth (LFO Depth)

Set the LFO Wave Depth (amplitude) for “Destination” parameter (above).

Settings: 0–127

Element Depth Ratio (LFO Element Depth Ratio)

Determines the offset values of the “Depth” parameter (above) for the respective Elements.

When set to “Off,” the LFO effect is not available. This is available only when Element-related parameters are set in “Destination.”

Settings: Off, 0–127

Normal Part (AWM2) Edit

Common

Part Settings

General

Pitch

Zone Settings

Zone Transmit

Effect

Routing

Ins A

Ins B

EQ

Ins Assign

Arpeggio

Common

Individual

Advanced

Motion Seq

Common

Lane

Mod / Control

▶ Part LFO

Control Assign

Receive SW

Element

Osc / Tune

Pitch EG

Filter

Type

Filter EG

Scale

Amplitude

Level / Pan

Amp EG

Scale

Element LFO

Element EQ

All Element

Osc

Balance

Copy or Exchange Elements

Edit User LFO

Calls up the User LFO Setting display. You can create a custom LFO wave consisting of up to sixteen steps.

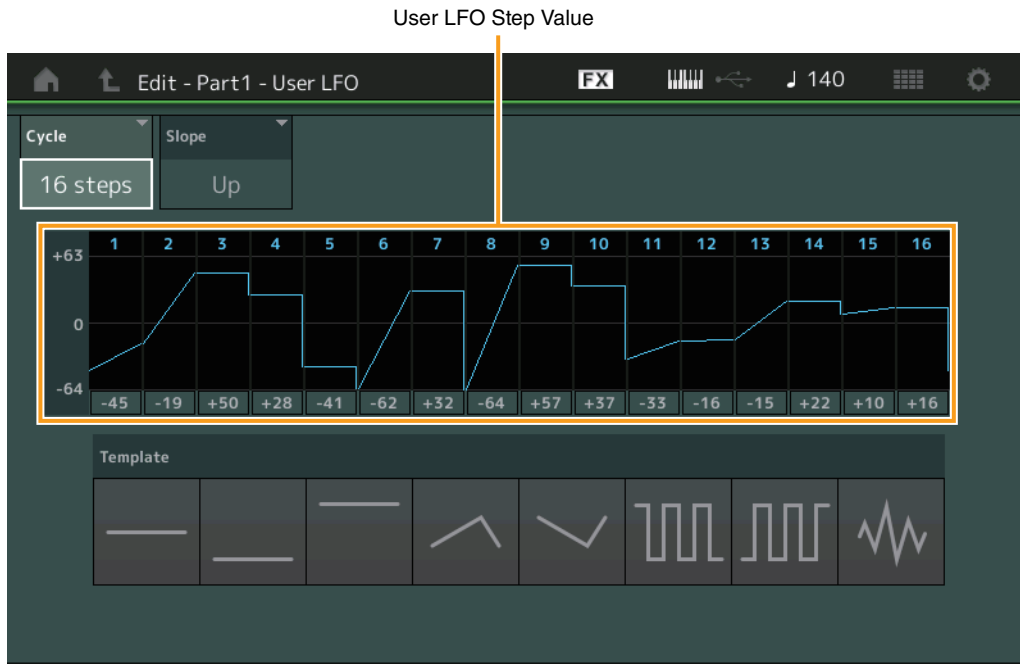

Cycle

Selects the desired step length for the LFO.

Settings: 2 steps, 3 steps, 4 steps, 6 steps, 8 steps, 12 steps, 16 steps

Slope

Determines the slope or ramp characteristics of the LFO wave.

Settings: Off (no slope), Up, Down, Up&Down

User LFO Step Value

Determines the level for each step.

Settings: -64 – +63

Template

This includes pre-programmed settings for creating an original LFO.

Normal Part (AWM2) Edit

Common

Part Settings

General

Pitch

Zone Settings

Zone Transmit

Effect

Routing

Ins A

Ins B

EQ

Ins Assign

Arpeggio

Common

Individual

Advanced

Motion Seq

Common

Lane

Mod / Control

▶ Part LFO

Control Assign

Receive SW

Element

Osc / Tune

Pitch EG

Filter

Type

Filter EG

Scale

Amplitude

Level / Pan

Amp EG

Scale

Element LFO

Element EQ

All Element

Osc

Balance

Copy or Exchange
Elements

Control Assign

From the Control Assign display you can make controller assign settings for the Part.

You can change sounds as desired by setting the desired controller to “Source” and the desired parameter to “Destination.” Not only physical controllers such as the Pitch Bend wheel but also Motion Sequencer or Envelope Follower can be set to “Source” as a virtual controller.

Up to 16 Controller Sets can be assigned to each Part.

Operation

[PERFORMANCE (HOME)] → [EDIT] → Part selection → Element [Common] → [Mod/Control] → [Control Assign]

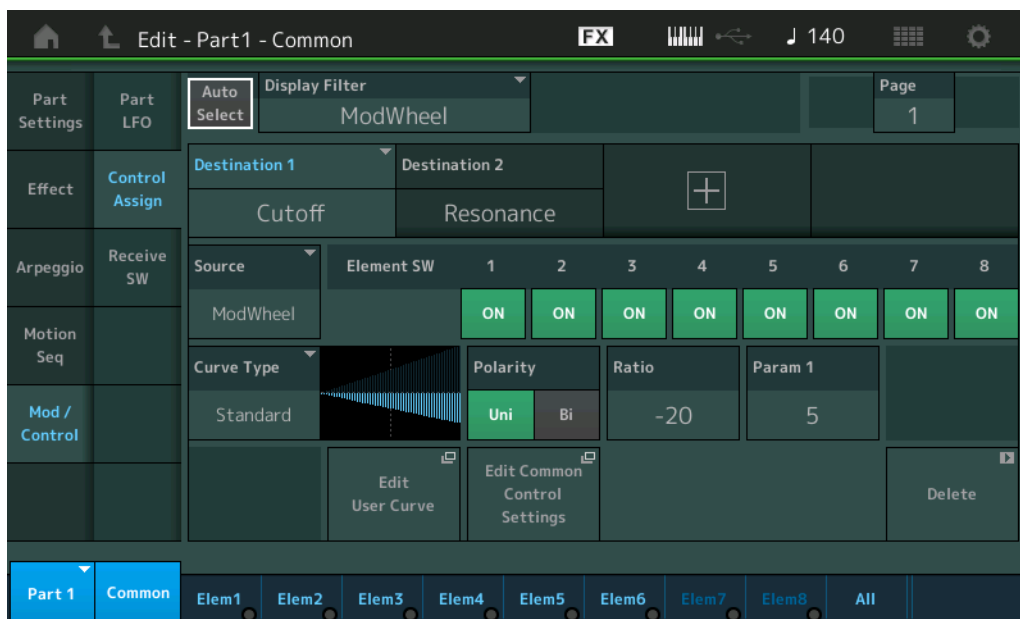

Auto Select (Auto Select Switch)

Determines whether the Auto Select function for Display Filter (below) is active (On) or not (Off). When this parameter is set to “On,” the operated Controller is automatically set in “Display Filter”. Also you can obtain the same result by pressing the [CONTROL ASSIGN] button.

Settings: Off, On

Display Filter

Determines the Controller to be displayed. When “Super Knob” is selected, all Assignable Knob settings to be affected by using the Super Knob are displayed.

Settings: PitchBend, ModWheel, AfterTouch, FootCtrl 1, FootCtrl 2, FootSwitch, Ribbon, Breath, AsgnKnob 1–8, Super Knob, AsgnSw 1, AsgnSw 2, MS Lane 1–4, EnvFollow 1–16, EnvFollowAD, EnvFollowMst, All

Display Name

Determines the name of each Assignable Knob 1–8 which is displayed in the Performance Play display (page 27). This is available only when “AsgnKnob 1–8” is set in “Source.”

Normal Part (AWM2) Edit

Common

Part Settings

General

Pitch

Zone Settings

Zone Transmit

Effect

Routing

Ins A

Ins B

EQ

Ins Assign

Arpeggio

Common

Individual

Advanced

Motion Seq

Common

Lane

Mod / Control

Part LFO

▶ Control Assign

Receive SW

Element

Osc / Tune

Pitch EG

Filter

Type

Filter EG

Scale

Amplitude

Level / Pan

Amp EG

Scale

Element LFO

Element EQ

All Element

Osc

Balance

Copy or Exchange Elements

Destination

Determines the target parameter to be controlled. To add another Destination, touch “+” icon. For information on setting examples for “Destination,” see below.

Settings: See the “Control List” in the Data List PDF document.

Destination Setting Examples

The following settings are some useful examples how to set the Destination.

To control the volume:	Part Param → Volume
To change the pitch:	Part Param → Pitch
To change the speed of the Rotary Speaker:	Ins A/B → InsA/B SpdCtrl *1
To apply a Wah pedal effect:	Ins A/B → InsA/B PdlCtrl *2

Concerning *1 and *2, the following settings are necessary in addition to the above settings.

*1 “Ins A/B Type” = “Rotary Speaker” in the Effect display of Part Edit

*2 “Ins A/B Type” = “VCM Pedal Wah” in the Effect display of Part Edit

Source

Determines the desired Controller for controlling the parameter set in “Destination.”

Settings: PitchBend, Modwheel, AfterTouch, FootCtrl 1, FootCtrl 2, FootSwitch, Ribbon, Breath, AsgnKnob 1–8, AsgnSw 1, AsgnSw 2, MS Lane 1–4, EnvFollow 1–16, EnvFollowAD, EnvFollowMst

Element SW (Element Switch)

Selects whether the controller will affect each individual Element (On) or not (Off). This is available only when Element-related parameters are set in “Destination.”

Settings: Off, On

Normal Part (AWM2) Edit

Common

Part Settings

General

Pitch

Zone Settings

Zone Transmit

Effect

Routing

Ins A

Ins B

EQ

Ins Assign

Arpeggio

Common

Individual

Advanced

Motion Seq

Common

Lane

Mod / Control

Part LFO

▶ Control Assign

Receive SW

Element

Osc / Tune

Pitch EG

Filter

Type

Filter EG

Scale

Amplitude

Level / Pan

Amp EG

Scale

Element LFO

Element EQ

All Element

Osc

Balance

Copy or Exchange Elements

Curve Type

Determines the Curve type of the parameter set in "Destination." In the illustrations below, the vertical axis indicates the operation value of the controller set in "Destination" and the horizontal axis indicates the parameter value set in "Source."

Settings: Standard, Sigmoid, Threshold, Bell, Dogleg, FM, AM, M, Discrete Saw, Smooth Saw, Triangle, Square, Trapezoid, Tilt Sine, Bounce, Resonance, Sequence, Hold, User 1–32 (when User Bank is selected), Library 1–8 (when the Library file is read)

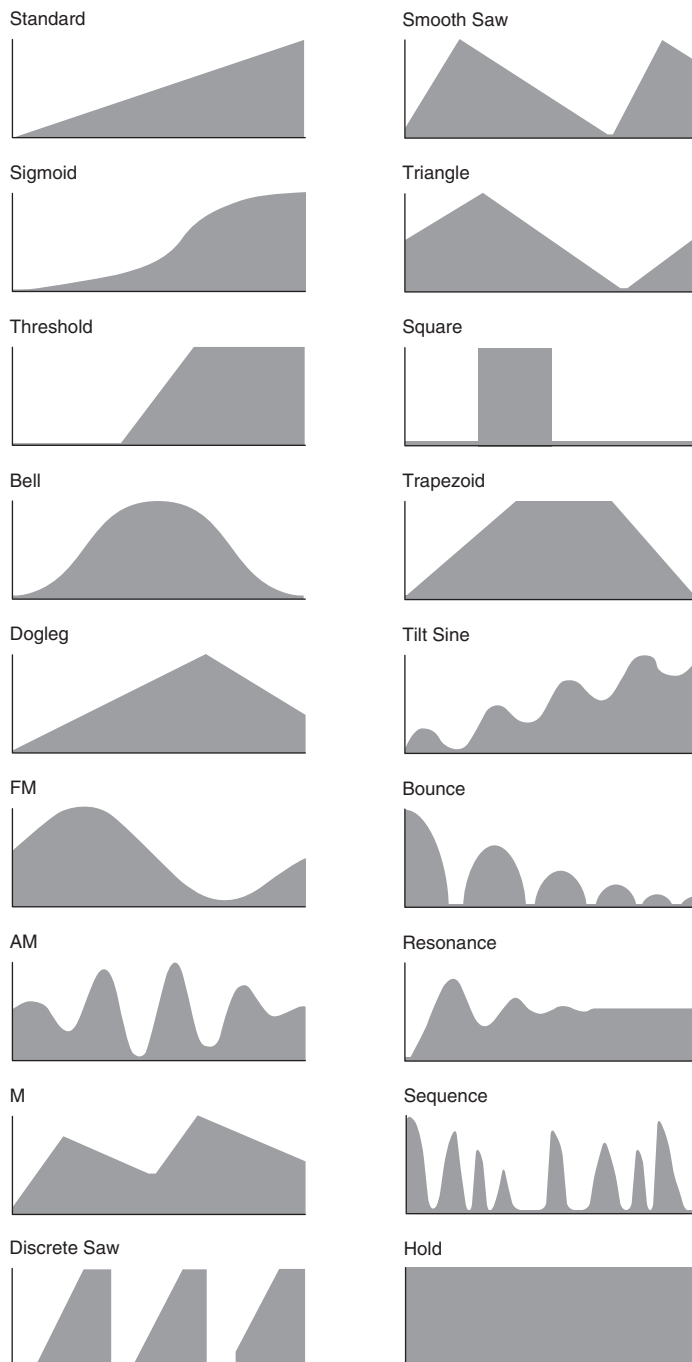

Polarity (Curve Polarity)

Determines the Curve Polarity of the Curve type set in "Curve Type."

Settings: Uni, Bi

Uni: Unipolar changes only in a positive direction or in a negative direction from a base parameter value according to the Curve shape.

Bi: Bipolar changes in both of positive and negative directions from a base parameter value.

Ratio (Curve Ratio)

Determines the Curve Ratio.

Settings: -64 – +63

Normal Part (AWM2) Edit

Common

Part Settings

General

Pitch

Zone Settings

Zone Transmit

Effect

Routing

Ins A

Ins B

EQ

Ins Assign

Arpeggio

Common

Individual

Advanced

Motion Seq

Common

Lane

Mod / Control

Part LFO

▶ Control Assign

Receive SW

Element

Osc / Tune

Pitch EG

Filter

Type

Filter EG

Scale

Amplitude

Level / Pan

Amp EG

Scale

Element LFO

Element EQ

All Element

Osc

Balance

Copy or Exchange Elements

Param 1/Param 2 (Curve Parameter)

Adjusts the Curve shape.

This is not available depending on the Curve Type.

Destination to Name

Copies the Parameter name from “Destination” to “Display Name.” This is available only when “Source” is set to “AsgnKnob 1–8.”

Edit Common Control Settings

Calls up the Control Assign display for Common/Audio Edit.

Delete

Deletes the selected “Destination.”

Edit User Curve

Calls up the User Curve Setting display. You can select “Linear” (Curve by Linear Interpolation of eight coefficients) or “Step.”

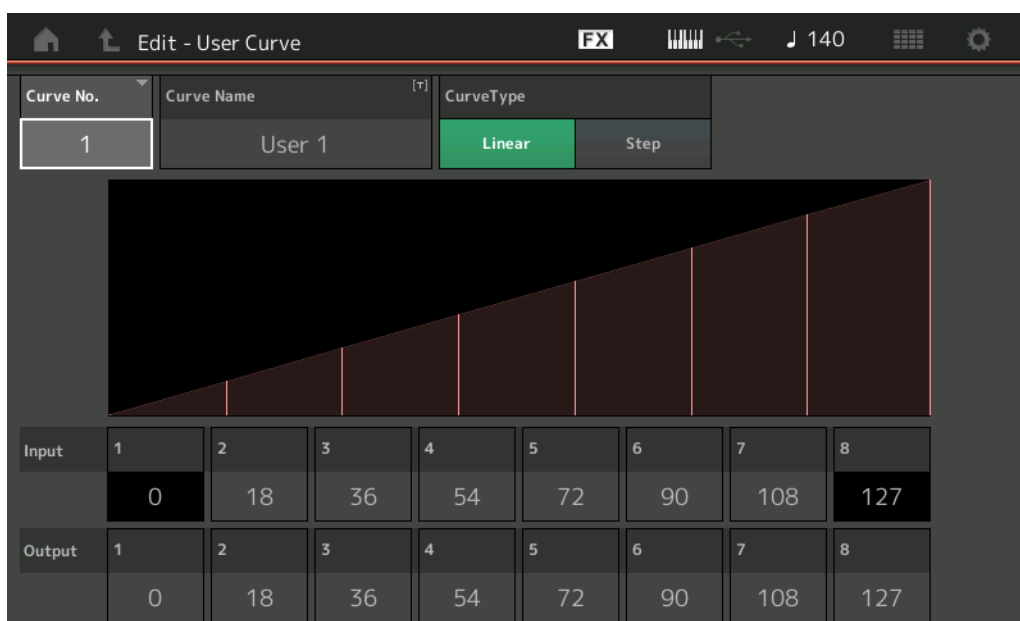

Curve No. (Curve Number)

Indicates the selected Curve Number.

Settings: 1–32

Curve Name

Names the selected Curve. Touching the parameter calls up the input character display.

Curve Type

Determines the Curve Type.

Settings: Linear, Step

Input

Determines the Input level of the Curve. “Input 1” is fixed to “0.” “Input 8” is fixed to 127 when the Curve Type is “Linear.”

Settings: 0–127

Output

Determines the Output level of the Curve.

Settings: 0–127

Normal Part (AWM2) Edit

Common

Part Settings

General

Pitch

Zone Settings

Zone Transmit

Effect

Routing

Ins A

Ins B

EQ

Ins Assign

Arpeggio

Common

Individual

Advanced

Motion Seq

Common

Lane

Mod / Control

Part LFO

▶ Control Assign

Receive SW

Element

Osc / Tune

Pitch EG

Filter

Type

Filter EG

Scale

Amplitude

Level / Pan

Amp EG

Scale

Element LFO

Element EQ

All Element

Osc

Balance

Copy or Exchange Elements

■ Selecting Controllers from a display other than Control Assign

While displays other than the Control Assign display are shown, you can select controllers using the [CONTROL ASSIGN] button on the panel. When the cursor is on the parameter that can be set as a Destination, the [CONTROL ASSIGN] button on the panel lights up. Press the [CONTROL ASSIGN] button while the button is lit, and the Destination Parameter display appears. Move the controller on the panel or touch a number shown on the display to select a Source. The Control Assign display then appears with the Source selected in the Destination Parameter display set as the Source.

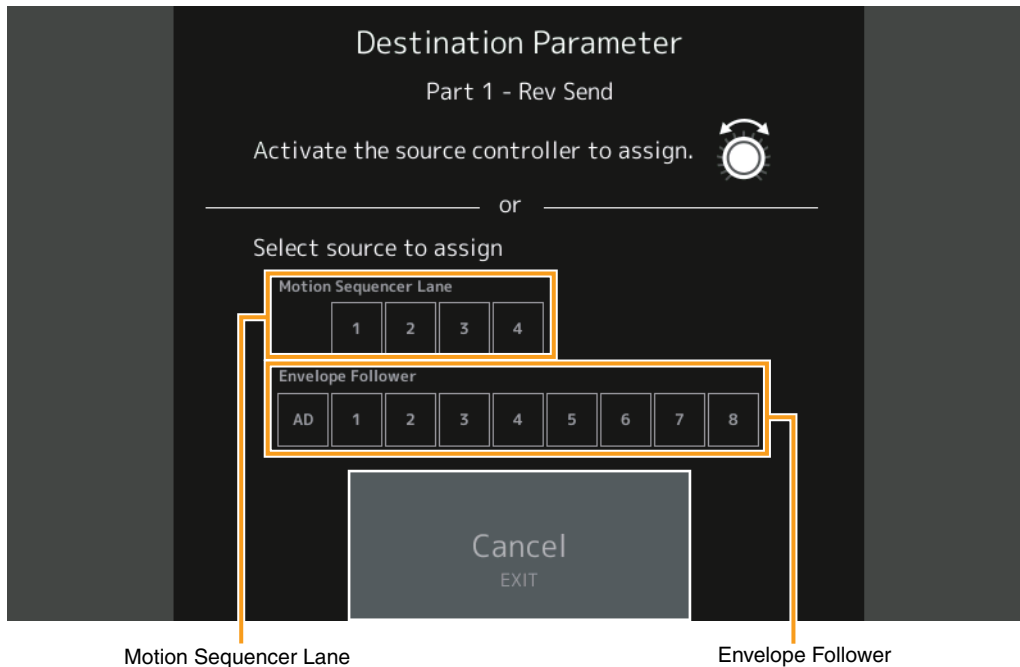

NOTE An error message appears when you move the Super knob and there are no more Assignable Knobs available for assigning a Source.

Normal Part (AWM2) Edit

Common

Part Settings

General

Pitch

Zone Settings

Zone Transmit

Effect

Routing

Ins A

Ins B

EQ

Ins Assign

Arpeggio

Common

Individual

Advanced

Motion Seq

Common

Lane

Mod / Control

Part LFO

▶ Control Assign

Receive SW

Element

Osc / Tune

Pitch EG

Filter

Type

Filter EG

Scale

Amplitude

Level / Pan

Amp EG

Scale

Element LFO

Element EQ

All Element

Osc

Balance

Copy or Exchange Elements

Receive SW (Receive Switch)

From the Receive Switch display you can set how each individual Part responds to various MIDI data, such as Control Change and Program Change messages. When the relevant parameter is set to "ON," the corresponding Part responds to the appropriate MIDI data.

NOTE If CC (Receive Control Change) here is set to "OFF," parameters related to Control Change are not available.

Operation

[PERFORMANCE (HOME)] → [EDIT] → Part selection → Element [Common] → [Mod/Control] → [Receive SW]

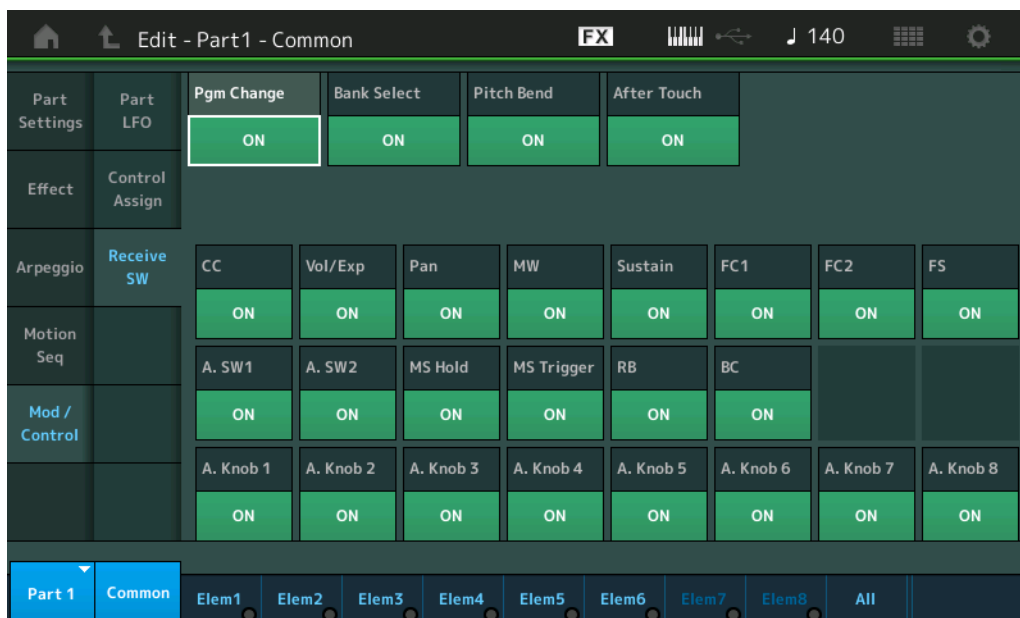

Pgm Change (Receive Program Change)

Determines whether Program Change messages are received or not.

Settings: Off, On

Bank Select (Receive Bank Select)

Determines whether Bank Select MSB/LSB messages are received or not.

This is not available when the Receive Control Change is set to Off.

Settings: Off, On

Pitch Bend (Receive Pitch Bend)

Determines whether MIDI messages generated by using the Pitch Bend Wheel are received or not.

Settings: Off, On

After Touch (Receive After Touch)

Determines whether After Touch messages are received or not.

Settings: Off, On

CC (Receive Control Change)

Determines whether Control Change messages are received or not.

Settings: Off, On

Vol/Exp (Receive Volume/Expression)

Determines whether volume messages are received or not.

This is not available when the Receive Control Change is set to Off.

Settings: Off, On

Pan (Receive Pan)

Determines whether Pan messages are received or not.

This is not available when the Receive Control Change is set to Off.

Settings: Off, On

Normal Part (AWM2) Edit

Common

Part Settings

General

Pitch

Zone Settings

Zone Transmit

Effect

Routing

Ins A

Ins B

EQ

Ins Assign

Arpeggio

Common

Individual

Advanced

Motion Seq

Common

Lane

Mod / Control

Part LFO

Control Assign

Receive SW

Element

Osc / Tune

Pitch EG

Filter

Type

Filter EG

Scale

Amplitude

Level / Pan

Amp EG

Scale

Element LFO

Element EQ

All Element

Osc

Balance

Copy or Exchange Elements

MW (Receive Modulation Wheel)

Determines whether MIDI messages generated by using the Modulation Wheel are received or not. This is not available when the Receive Control Change is set to Off.

Settings: Off, On

Sustain (Receive Sustain)

Determines whether Sustain messages are received or not. This is not available when the Receive Control Change is set to Off.

Settings: Off, On

FC1/FC2 (Receive Foot Controller)

Determines whether MIDI messages generated by pressing the optional Foot Controller are received or not.

This is not available when the Receive Control Change is set to Off.

Settings: Off, On

FS (Receive Foot Switch)

Determines whether MIDI messages generated by pressing the optional Foot Switch are received or not. This is not available when the Receive Control Change is set to Off.

Settings: Off, On

A. SW1/A. SW2 (Receive Assignable Switch)

Determines whether MIDI messages generated by pressing the [ASSIGN 1] and [ASSIGN 2] buttons are received or not.

This is not available when the Receive Control Change is set to Off.

Settings: Off, On

MS Hold (Receive Motion Sequencer Hold)

Determines whether MIDI messages generated by pressing the [MOTION SEQ HOLD] button are received or not.

This is not available when the Receive Control Change is set to Off.

Settings: Off, On

MS Trigger (Receive Motion Sequencer Trigger)

Determines whether MIDI messages generated by pressing the [MOTION SEQ TRIGGER] button are received or not.

This is not available when the Receive Control Change is set to Off.

Settings: Off, On

RB (Receive Ribbon Controller)

Determines whether MIDI messages for Ribbon Controller are received or not. This is not available when the Receive Control Change is set to Off.

Settings: Off, On

BC (Receive Breath Controller)

Determines whether MIDI messages for Breath Controller are received or not. This is not available when the Receive Control Change is set to Off.

Settings: Off, On

A. Knob 1–8 (Receive Assignable Knob)

Determines whether MIDI messages generated by using the Assignable Knobs 1–4 (5–8) are received or not.

This is not available when the Receive Control Change is set to Off.

Settings: Off, On

Normal Part (AWM2) Edit

Common

Part Settings

General

Pitch

Zone Settings

Zone Transmit

Effect

Routing

Ins A

Ins B

EQ

Ins Assign

Arpeggio

Common

Individual

Advanced

Motion Seq

Common

Lane

Mod / Control

Part LFO

Control Assign

▶ Receive SW

Element

Osc / Tune

Pitch EG

Filter

Type

Filter EG

Scale

Amplitude

Level / Pan

Amp EG

Scale

Element LFO

Element EQ

All Element

Osc

Balance

 Copy or Exchange
 Elements

Element Edit (Element)

Osc/Tune (Oscillator/Tune)

From the Oscillator/Tune display you can assign the waveform (or basic sound material) to each Element. You can set the note range for the Element (the range of notes on the keyboard over which the Element will sound) as well as the velocity response (the range of note velocities within which the Element will sound).

Operation [PERFORMANCE (HOME)] → [EDIT] → Part selection → Element selection → [Osc/Tune]

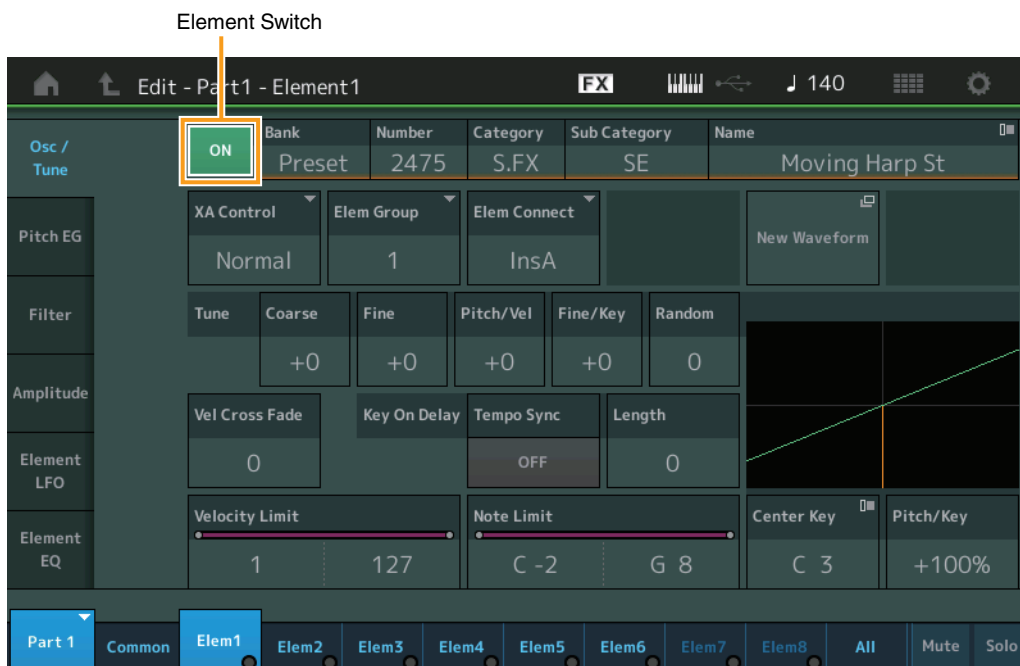

Bank (Waveform Bank)

Number (Waveform Number)

Category (Waveform Category)

Sub Category (Waveform Sub Category)

Name (Waveform Name)

Indicates the information of the waveform used for the selected Element. "Bank" indicates which waveform location (Preset, User and Library) is assigned to the Element.

Settings: See the Data List PDF document.

Element Switch

Determines whether the currently selected Element is on or off.

Settings: Off, On

XA Control

Determines the functioning of the Expanded Articulation (XA) feature of an Element.

The XA feature is sophisticated tone generator system that allows you to more effectively recreate realistic sound and natural performance techniques. It also provides other unique modes for random and alternate sound changes as you play. For details on the XA feature, see the "Tone Generator Block" in the "Basic Structure" on [page 6](#).

Settings: Normal, Legato, Key Off, Cycle, Random, A.SW Off, A.SW1 On, A.SW2 On

For each Element, you can set to:

Normal: The Element sounds normally each time you play the note.

Legato: When the Mono/Poly parameter is set to Mono, this Element will be played in place of the one which is set to "Normal" of the XA Control parameter when you play the keyboard in legato fashion (playing the next note of a single-note line or melody before releasing the previous note).

Key Off: The Element will sound each time you release the note.

Cycle (for multiple Elements): Each Element sounds alternately according to its numerical order. In other words, playing the first note will sound Element 1, the second note Element 2, and so on.

Random (for multiple Elements): Each Element will sound randomly each time you play the note.

A.SW1 On: When the [ASSIGN 1] button is turned On, the Element will sound.

A.SW2 On: When the [ASSIGN 2] button is turned On, the Element will sound.

A.SW Off: When both the [ASSIGN 1] and [ASSIGN 2] buttons are turned Off, the Element will sound.

Normal Part (AWM2) Edit

Common

Part Settings

General

Pitch

Zone Settings

Zone Transmit

Effect

Routing

Ins A

Ins B

EQ

Ins Assign

Arpeggio

Common

Individual

Advanced

Motion Seq

Common

Lane

Mod / Control

Part LFO

Control Assign

Receive SW

Element

Osc / Tune

Pitch EG

Filter

Type

Filter EG

Scale

Amplitude

Level / Pan

Amp EG

Scale

Element LFO

Element EQ

All Element

Osc

Balance

Copy or Exchange Elements

Elem Group (Element Group)

Determines the group for XA Control. All Elements that have the same type of XA features must have the same group number. This setting does not apply when the XA Control parameters of all Elements are set to Normal.

Settings: 1–8

Elem Connect (Element Connection Switch)

Determines which Insertion Effect (A or B) is used to process each individual Element. Set this to “Thru” to bypass the Insertion Effects for the specified element.

Settings: Thru, InsA, InsB

New Waveform

Loads Audio data stored in the USB flash drive as “Waveform.” For details on loading, see “Load” (page 198).

After the Waveform is loaded, the Edit Waveform parameter (below) will be available.

Coarse (Coarse Tune)

Determines the pitch of each Element in semitones.

Settings: -48 – +48

Fine (Fine Tune)

Determines the fine tuning for the pitch of each Element.

Settings: -64 – 63

Pitch/Vel (Pitch Velocity Sensitivity)

Determines how the pitch of the selected Element responds to velocity.

Settings: -64 – 63

Positive values: The harder you play the keyboard, the more the pitch rises.

Negative values: The harder you play the keyboard, the more the pitch falls.

0: No change in pitch.

Fine/Key (Pitch Fine Key Follow Sensitivity)

Determines the degree to which the notes (specifically, their position or octave range) affect the pitch in Fine Tuning.

Settings: -64 – 63

Positive values: The pitch of lower notes drops and that of higher notes rises.

Negative values: The pitch of lower notes rises and that of higher notes drops.

Random (Random Pitch Depth)

Allows you to randomly vary the pitch of the Element for each note you play. The higher the value, the greater the pitch variation.

Settings: 0–127

Vel Cross Fade (Velocity Cross Fade)

Determines how gradually the volume of an Oscillator decreases in proportion to the distance of Velocity changes outside the Velocity Limit setting.

Settings: 0–127

The higher the value, the more gradually the volume decreases.

0: No sound

Tempo Sync (Key On Delay Tempo Sync Switch)

Determines whether or not “Key On Delay” (below) is synchronized to the tempo.

Settings: Off, On

Length (Key On Delay Time Length)

Determines the time (or elapsed delay) between the moment you press a note on the keyboard and the point at which the sound is actually played. You can set different delay times for each Element. This is not available when “Key On Delay Tempo Sync” is set to on.

Settings: 0–127

Normal Part (AWM2) Edit

Common

Part Settings

General

Pitch

Zone Settings

Zone Transmit

Effect

Routing

Ins A

Ins B

EQ

Ins Assign

Arpeggio

Common

Individual

Advanced

Motion Seq

Common

Lane

Mod / Control

Part LFO

Control Assign

Receive SW

Element

▶ Osc / Tune

Pitch EG

Filter

Type

Filter EG

Scale

Amplitude

Level / Pan

Amp EG

Scale

Element LFO

Element EQ

All Element

Osc

Balance

Copy or Exchange Elements

Length (Key On Delay Note Length)

Determines the timing of “Key On Delay” when “Key On Delay Tempo Sync” is set to on.

Settings: 1/16, 1/8 Tri. (eighth-note triplets), 1/16 Dot. (dotted sixteenth notes), 1/8, 1/4 Tri. (quarter-note triplets), 1/8 Dot. (dotted eighth notes), 1/4, 1/2 Tri. (half-note triplets), 1/4 Dot. (dotted quarter notes), 1/2, Whole Tri. (whole-note triplets), 1/2 Dot. (dotted half notes), 1/4 x 4 (quarter-note quadruplets; four quarter notes to the beat), 1/4 x 5 (quarter-note quintuplets; five quarter notes to the beat), 1/4 x 6 (quarter-note sextuplets; six quarter notes to the beat), 1/4 x 7 (quarter-note septuplets; seven quarter notes to the beat), 1/4 x 8 (quarter-note octuplets; eight quarter notes to the beat)

Velocity Limit

Determines the minimum and maximum values of the velocity range within which each Element will respond. Each Element will only sound for notes played within its specified velocity range. If you first specify the maximum value and then the minimum value, for example “93 to 34,” then the Velocity range covers both “1 to 34” and “93 to 127.”

Settings: 1–127

Note Limit

Determines the lowest and highest notes of the keyboard range for each Element. Each Element will only sound for notes played within its specified range. If you first specify the highest note and then the lowest note, for example “C5 to C4,” then the note range covers both “C-2 to C4” and “C5 to G8.”

Settings: C -2 – G8

Pitch/Key (Pitch Key Follow Sensitivity)

Determines the sensitivity of the Key Follow effect (the pitch interval of adjacent notes), assuming the pitch of the Center Key (below) as standard.

Settings: -200% – +0% – +200%

+100% (the normal setting): Adjacent notes are pitched one semitone apart.

0%: All notes have the same pitch as the Center Key.

Negative values: The settings are reversed.

Center Key (Pitch Key Follow Sensitivity Center Key)

Determines the central note or pitch for the Key Follow effect on pitch.

Settings: C -2 – G8

Edit Waveform

Calls up the Waveform Edit display.

From this display you can set parameters related to Key Banks consisting of the Waveform.

• Key Bank

A Key Bank is digital audio data, made by directly recording a signal, such as that of vocals or electric guitar, to this instrument.

Throughout this manual, the words “Key Bank” and “Wave” are sometimes used interchangeably; however, you should be careful to distinguish between “Key Bank” (raw audio data) and “Waveform” (collected audio data used to make up a Part).

• Key Bank and Waveform

Key Banks are assigned and stored to Waveforms on the MODX.

Each of the Waveforms can contain multiple Key Banks. To assign these Key Banks to a different space or container, you can set the note limit and velocity limit for each Key Bank. With this setting, the different Key Bank is played back depending on the pressed note and its velocity.

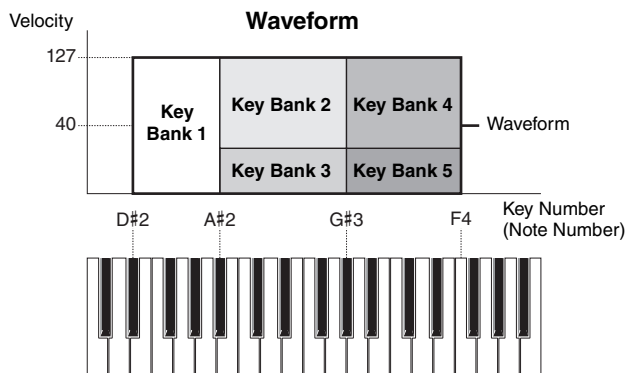

Normal Part (AWM2) Edit

Common

Part Settings

General

Pitch

Zone Settings

Zone Transmit

Effect

Routing

Ins A

Ins B

EQ

Ins Assign

Arpeggio

Common

Individual

Advanced

Motion Seq

Common

Lane

Mod / Control

Part LFO

Control Assign

Receive SW

Element

► Osc / Tune

Pitch EG

Filter

Type

Filter EG

Scale

Amplitude

Level / Pan

Amp EG

Scale

Element LFO

Element EQ

All Element

Osc

Balance

Copy or Exchange Elements

• Part and Waveform

You can play the Waveform by assigning it to a Part then playing the keyboard with that Part. You can assign the Waveform to an Element of the Part in the Element Edit for the Normal Part (AWM2) Edit ([page 107](#)) and the Key Edit for the Drum Part Edit ([page 140](#)).

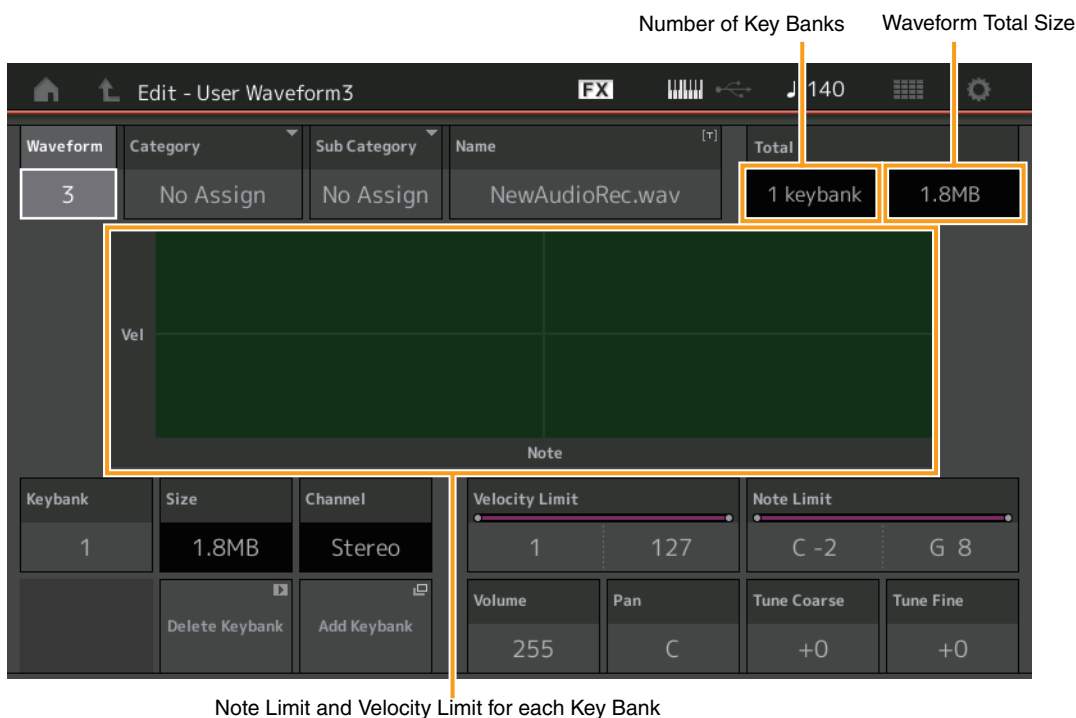

Note Limit and Velocity Limit for each Key Bank

Waveform

Indicates the selected Waveform.

Category (Waveform Main Category)

Sub Category (Waveform Sub Category)

Determines the Main category and the Sub category for the selected Waveform.

Settings: See the Data List PDF document.

Name (Waveform Name)

Determines the selected Waveform. Waveform names can contain up to 20 characters. Touching the parameter calls up the input character display.

Number of Keybank (Number of Key Bank)

Indicates the number of Key Banks in the selected Waveform.

Waveform Total Size

Indicates the total data size of the selected Waveform.

Keybank (Key Bank)

Indicates the selected Key Bank.

Size (Key Bank Size)

Indicates the data size of the selected Key Bank.

Channel (Key Bank Channel)

Indicates the Channel (Stereo or Mono) of the selected Key Bank.

Velocity Limit

Determines the minimum and maximum values of the velocity range within which the selected Key Bank will respond.

Settings: 1–127

Note Limit

Determines the lowest and highest notes of the keyboard range for the selected Key Bank.

Settings: 1–127

Normal Part (AWM2) Edit

Common

Part Settings

General
Pitch
Zone Settings
Zone Transmit

Effect

Routing
Ins A
Ins B
EQ
Ins Assign

Arpeggio

Common
Individual
Advanced

Motion Seq

Common
Lane

Mod / Control

Part LFO
Control Assign
Receive SW

Element

Osc / Tune

Pitch EG

Filter

Type
Filter EG
Scale

Amplitude

Level / Pan
Amp EG
Scale

Element LFO

Element EQ

All Element

Osc
Balance

Copy or Exchange Elements

Normal Part (AWM2)

Drum Part

Normal Part (FM-X)

Common/Audio

Volume

Determines the output volume of the selected Key Bank.

Settings: 0–255

Pan

Determines the stereo pan position of the selected Key Bank.

Settings: L63–C–R63

Tune Coarse (Coarse Tune)

Determines the pitch of the selected Key Bank in semitones.

Settings: -64 – +63

Tune Fine (Fine Tune)

Determines the fine tuning for the pitch of the selected Key Bank.

Settings: -64 – +63

Delete Keybank (Delete Key Bank)

Deletes the selected Key Bank.

Add Keybank (Add Key Bank)

Adds new Key Bank to the selected Waveform.

Pitch EG

From the Pitch EG display you can make all time and level settings for the Pitch EG, which determine how the pitch of the sound changes over time for Oscillators. These can be used to control the change in pitch from the moment a note is pressed on the keyboard to the moment the sound stops.

Operation

[PERFORMANCE (HOME)] → [EDIT] → Part selection → Element selection → [Pitch EG]

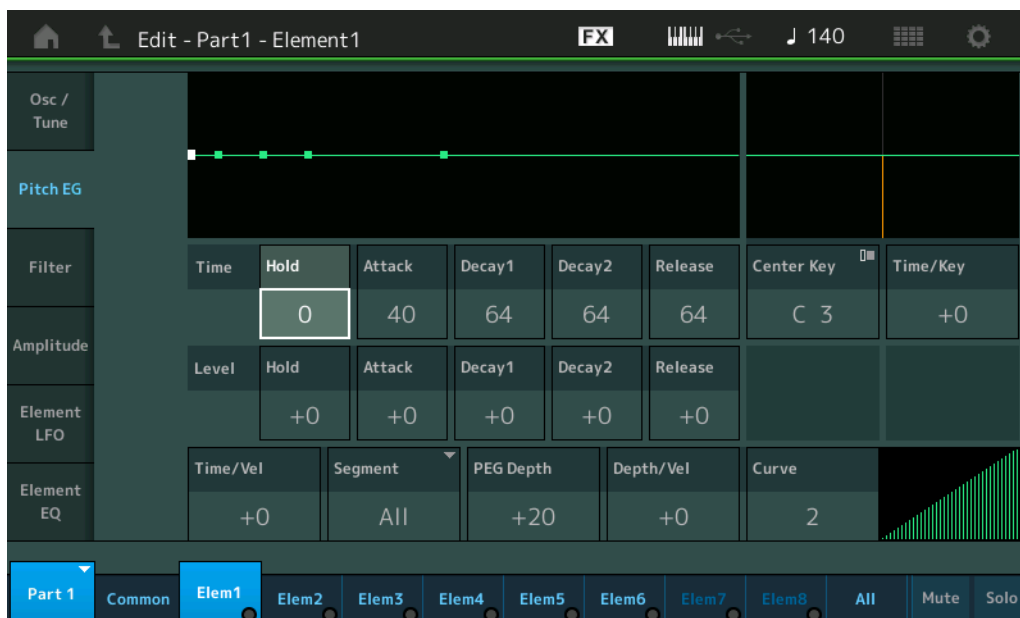

The full names of the available parameters are shown in the chart below, as they appear in the display.

	Hold	Attack	Decay1	Decay2	Release
Time	Hold Time	Attack Time	Decay1 Time	Decay2 Time	Release Time
Level	Hold Level	Attack Level	Decay1 Level	Decay2 Level	Release Level

Settings: Time: 0–127

Level: -128 – +127

Normal Part (AWM2) Edit

Common

Part Settings

General

Pitch

Zone Settings

Zone Transmit

Effect

Routing

Ins A

Ins B

EQ

Ins Assign

Arpeggio

Common

Individual

Advanced

Motion Seq

Common

Lane

Mod / Control

Part LFO

Control Assign

Receive SW

Element

▶ Osc / Tune

▶ Pitch EG

Filter

Type

Filter EG

Scale

Amplitude

Level / Pan

Amp EG

Scale

Element LFO

Element EQ

All Element

Osc

Balance

Copy or Exchange Elements

Time/Key (PEG Time Key Follow Sensitivity)

Determines the degree to which the notes (specifically, their position or octave range) affect the Pitch EG times. The Center Key (next parameter) is used as the basic pitch for this parameter.

Settings: -64 – +63

Positive values: High notes result in a high PEG transition speed while low notes result in a slow speed.

Negative values: High notes result in a slow PEG transition speed while low notes result in a high speed.

0: The PEG transition speed does not change, regardless of the played note.

Center Key (PEG Time Key Follow Sensitivity Center Key)

Determines how the PEG transition time (speed) responds to Velocity, or to the strength with which the key is pressed. When the Center Key note is played, the PEG behaves according to its actual settings.

Settings: C-2–G8

Time/Vel (PEG Time Velocity Sensitivity)

Segment (PEG Time Velocity Sensitivity Segment)

Determines the velocity sensitivity of the PEG's Time parameters. Select the Segment, and then set its "Time/Vel" parameter.

Settings: Time/Vel: -64 – +63

Positive values: High Velocities result in a fast PEG transition speed while low Velocities result in a slow speed.

Negative values: High Velocities result in a slow PEG transition speed while low Velocities result in a fast speed.

0: The PEG transition speed does not change, regardless of the Velocity.

Settings: Segment: Attack, Atk+Dcy (Attack+Decay), Decay, Atk+Rls (Attack+Release), All

Attack: Time/Vel parameter affects Attack Time.

Atk+Dcy: Time/Vel Value affects Attack/Decay1 Time.

Decay: Time/Vel parameter affects Decay Time

Atk+Rls: Time/Vel Value affects Attack/Release Time.

All: Time/Vel affects all PEG Time parameters.

PEG Depth

Determines the pitch range for Pitch EG.

Settings: -64 – +63

Depth/Vel (PEG Depth Velocity Sensitivity)

Curve (PEG Depth Velocity Sensitivity Curve)

Determines how the pitch range will be generated according to the Velocity (strength) with which you play notes on the keyboard. The Curve parameter lets you select from five different preset velocity curves (graphically indicated in the display) that determine how velocity affects the Pitch EG Depth. In the illustrations below, the vertical axis indicates Pitch Change and the horizontal axis indicates Velocity.

Settings: Depth/Vel: -64 – +63

Positive values: High Velocities cause the pitch range to expand and low Velocities cause it to contract.

Negative values: High Velocities cause the pitch range to contract and low Velocities cause it to expand.

0: The pitch envelope does not change, regardless of the Velocity.

Settings: Curve: 0–4

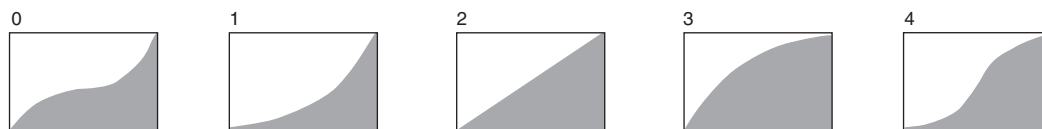

NOTE For details on PEG, see the Synthesizer Parameter Manual PDF document.

Normal Part (AWM2) Edit

Common

Part Settings

General

Pitch

Zone Settings

Zone Transmit

Effect

Routing

Ins A

Ins B

EQ

Ins Assign

Arpeggio

Common

Individual

Advanced

Motion Seq

Common

Lane

Mod / Control

Part LFO

Control Assign

Receive SW

Element

Osc / Tune

▶ Pitch EG

Filter

Type

Filter EG

Scale

Amplitude

Level / Pan

Amp EG

Scale

Element LFO

Element EQ

All Element

Osc

Balance

Copy or Exchange
Elements

Filter

Type

From the Type display you can make comprehensive settings for the Filter unit. The available parameters differ depending on which Filter type is selected here.

Operation [PERFORMANCE (HOME)] → [EDIT] → Part selection → Element selection → [Filter] → [Type]

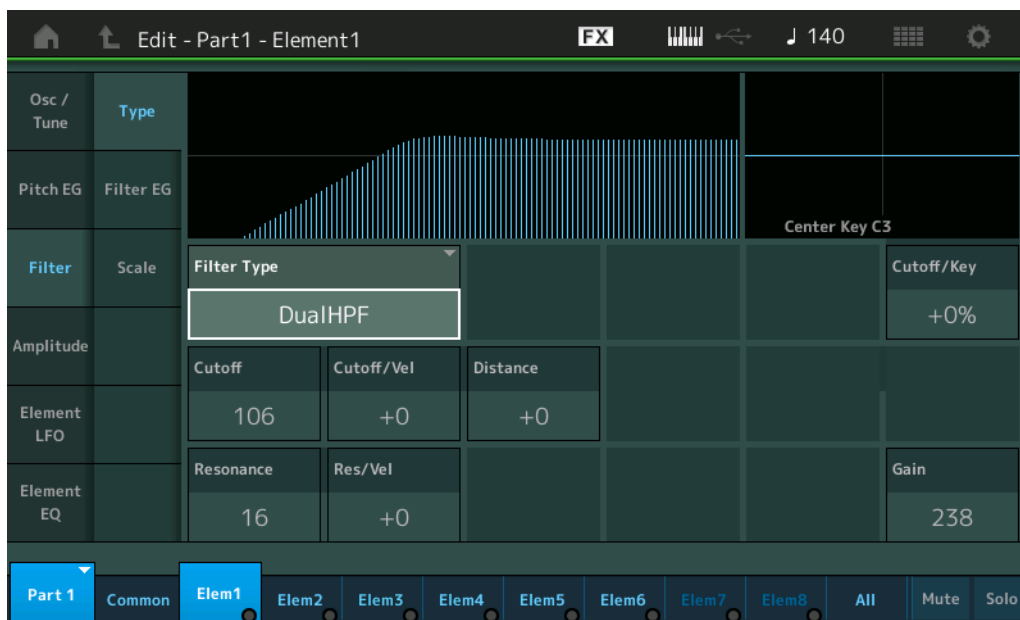

Filter Type

Determines the Filter Type for the current Element. Basically, there are four different filters: LPF (Low Pass Filter), HPF (High Pass Filter), BPF (Band Pass Filter) and BEF (Band Elimination Filter). For details on settings, see the Synthesizer Parameter Manual PDF document.

Settings: LPF24D, LPF24A, LPF18, LPF18s, LPF12+HPF12, LPF6+HPF12, HPF24D, HPF12, BPF12D, BPFw, BPF6, BEF12, BEF6, DualLPF, DualHPF, DualBPF, DualBEF, LPF12+BPF6, Thru

LPF

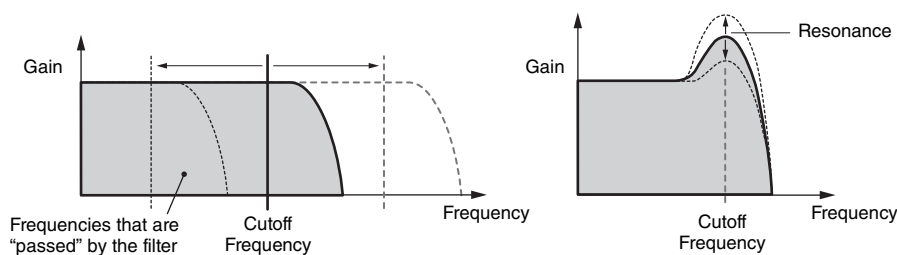

LPF24D: A dynamic -24 dB/oct Low-Pass Filter with a characteristic digital sound. Compared to the LPF24A type, this filter can produce a more pronounced Resonance effect.

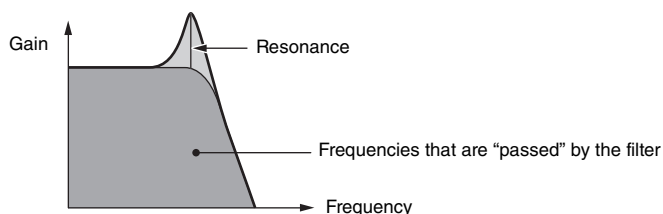

LPF24A: A digital dynamic Low-Pass Filter with characteristics similar to a 4-pole analog synthesizer filter.

LPF18: 3-pole -18 dB/oct Low-Pass Filter.

LPF18s: 3-pole -18 dB/oct Low-Pass Filter. This filter has a smoother cutoff slope than the LPF18 type.

Normal Part (AWM2) Edit

Common

Part Settings

General

Pitch

Zone Settings

Zone Transmit

Effect

Routing

Ins A

Ins B

EQ

Ins Assign

Arpeggio

Common

Individual

Advanced

Motion Seq

Common

Lane

Mod / Control

Part LFO

Control Assign

Receive SW

Element

Osc / Tune

Pitch EG

Filter

Type

Filter EG

Scale

Amplitude

Level / Pan

Amp EG

Scale

Element LFO

Element EQ

All Element

Osc

Balance

Copy or Exchange Elements

Normal Part (AWM2)

Drum Part

Normal Part (FM-X)

Common/Audio

HPF

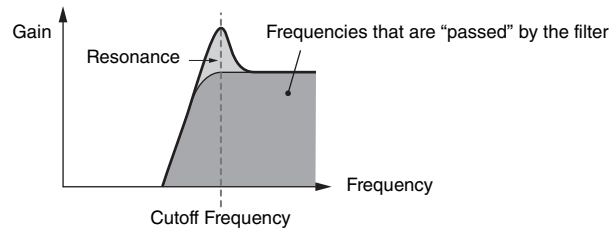

LPF12+HPF12: A combination of a -12 dB/oct Low-Pass Filter and a -12 dB/oct High-Pass Filter connected in serial. When this Filter Type is selected, HPF Cutoff and HPF Key Follow Sensitivity can be set

LPF6+HPF12: A combination of a -6 dB/oct Low-Pass Filter and a -12 dB/oct High-Pass Filter connected in serial. When this Filter Type is selected, HPF Cutoff and HPF Key Follow Sensitivity can be set.

HPF24D: A dynamic -24 dB/oct High-Pass Filter with a characteristic digital sound. This filter can produce a pronounced Resonance effect.

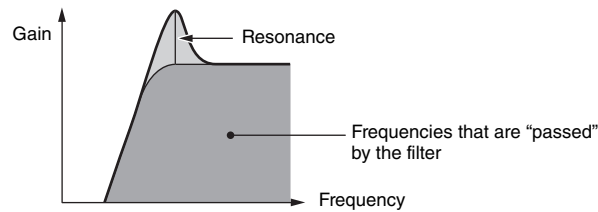

HPF12: -12 dB/oct dynamic High-Pass Filter.

BPF

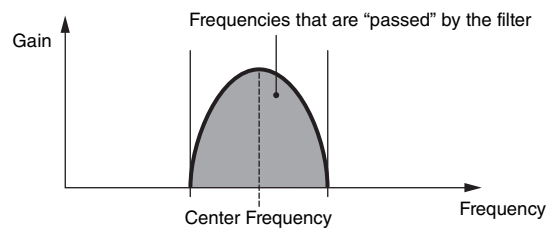

BPF12D: The combination of a -12 dB/oct HPF and LPF with a characteristic digital sound.

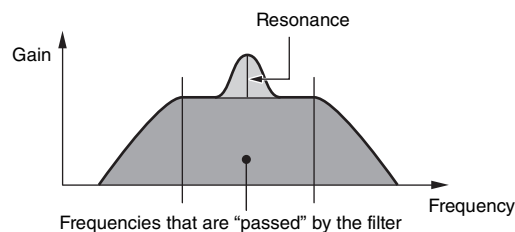

BPFw: A -12 dB/oct BPF that combines HPF and LPF filters to allow wider bandwidth settings.

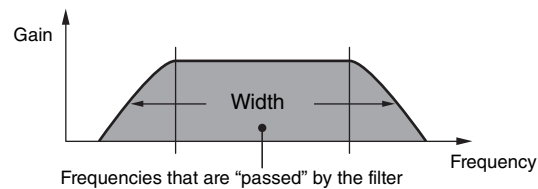

BPF6: The combination of a -6 dB/oct HPF and LPF.

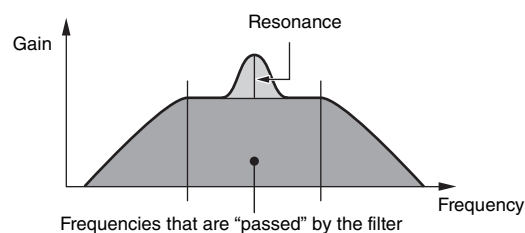

Normal Part (AWM2) Edit

Common

Part Settings

General

Pitch

Zone Settings

Zone Transmit

Effect

Routing

Ins A

Ins B

EQ

Ins Assign

Arpeggio

Common

Individual

Advanced

Motion Seq

Common

Lane

Mod / Control

Part LFO

Control Assign

Receive SW

Element

Osc / Tune

Pitch EG

Filter

Type

Filter EG

Scale

Amplitude

Level / Pan

Amp EG

Scale

Element LFO

Element EQ

All Element

Osc

Balance

Copy or Exchange Elements

Normal Part (AWM2)

Drum Part

Normal Part (FM-X)

Common/Audio

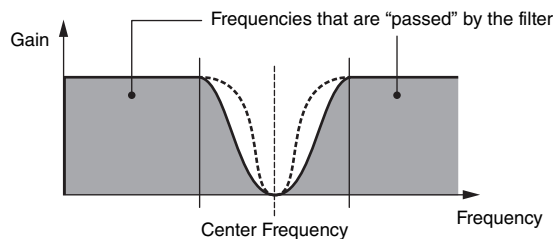
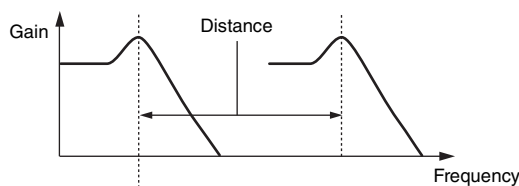
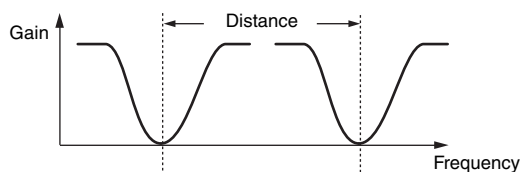
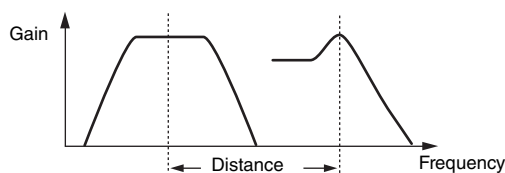
BEF**BEF12:** -12 dB/oct Band-Eliminate Filter.**BEF6:** -6 dB/oct Band-Eliminate Filter.**DualLPF:** Two -12 dB/oct Low-Pass Filters connected in parallel. You can edit the distance between the two Cutoff Frequencies.Lower Cutoff Frequency is set directly on the display
(and Higher Cutoff Frequency is automatically set)**DualHPF:** Two -12 dB/oct High-Pass Filters connected in parallel.**DualBPF:** Two -6 dB/oct Band-Pass Filters connected in parallel.**DualBEF:** Two -6 dB/oct Band-Eliminate Filters connected in serial.Lower Cutoff Frequency is set directly on the display
(and Higher Cutoff Frequency is automatically set)**LPF12+BPF6:** A combination of a -12 dB/oct Low-Pass Filter and a -6 dB/oct Band-Pass Filter connected in parallel. You can edit the distance between the two Cutoff Frequencies.Lower Cutoff Frequency is set directly on the display
(and Higher Cutoff Frequency is automatically set)**Cutoff (Cutoff Frequency)**

Determines the cutoff frequency for the Filter. This is used as the basic frequency for the selected Filter Type.

Settings: 0–255**Cutoff/Vel (Cutoff Velocity Sensitivity)**

Determines how the Cutoff Frequency responds to Velocity, or the strength with which you play notes.

Settings: -64 – +63**Positive values:** The more strongly you play the keyboard, the more the Cutoff Frequency rises.**Negative values:** The more softly you play the keyboard, the more the Cutoff Frequency rises.**0:** The Cutoff Frequency does not change, regardless of the Velocity.

Normal Part (AWM2) Edit

Common

Part Settings

General

Pitch

Zone Settings

Zone Transmit

Effect

Routing

Ins A

Ins B

EQ

Ins Assign

Arpeggio

Common

Individual

Advanced

Motion Seq

Common

Lane

Mod / Control

Part LFO

Control Assign

Receive SW

Element

Osc / Tune

Pitch EG

Filter

Type

Filter EG

Scale

Amplitude

Level / Pan

Amp EG

Scale

Element LFO

Element EQ

All Element

Osc

Balance

Copy or Exchange Elements

Resonance

Width

This parameter's function varies according to the selected Filter Type. If the selected filter is an LPF, HPF, BPF (excluding BPFw), or BEF, this parameter is used to set the Resonance. For the BPFw, it is used to adjust the frequency bandwidth. This parameter is used to set the amount of Resonance (harmonic emphasis) applied to the signal at the cutoff frequency. This can be used in combination with the "Cutoff" parameter to add further character to the sound. For the BPFw, this parameter is used to adjust the width of the band of signal frequencies passed by the filter.

This parameter is not displayed depending on the selected Filter Types.

Settings: 0–127

Cutoff/Key (Cutoff Key Follow Sensitivity)

Determines the degree to which the notes (specifically, their position or octave range) affect the Cutoff Frequency (above). The Center Key (next parameter) is used as the basic Cutoff Frequency for this parameter.

Settings: -200% – +200%

Positive values: The Cutoff Frequency drops for lower notes and rises for higher notes.

Negative values: The Cutoff Frequency rises for lower notes and drops for higher notes.

Center Key (Cutoff Key Follow Sensitivity Center Key)

This indicates that the central note for "Cutoff/Key" above is C3. Keep in mind that this is for display purposes only; the value cannot be changed.

Gain

Sets the Gain (the amount of boost applied to the signal sent to the Filter Unit).

■ In case of the Filter Type with "Distance" and "Res/Vel" parameters



Distance

Determines the distance between the Cutoff Frequencies for the Dual Filter types and the LPF12+BPF6 filter. This parameter is not displayed depending on the selected Filter Type.

Settings: -128 – +127

Res/Vel (Resonance Velocity Sensitivity)

Determines the degree to which Resonance responds to Velocity, or the strength with which you play notes. This parameter is not displayed depending on the selected Filter Type.

Settings: -64 – +63

Positive values: The higher the Velocity, the greater the Resonance.

Negative values: The lower the Velocity, the greater the Resonance.

0: No change of the Resonance value.

Normal Part (AWM2) Edit

Common

Part Settings

General

Pitch

Zone Settings

Zone Transmit

Effect

Routing

Ins A

Ins B

EQ

Ins Assign

Arpeggio

Common

Individual

Advanced

Motion Seq

Common

Lane

Mod / Control

Part LFO

Control Assign

Receive SW

Element

Osc / Tune

Pitch EG

Filter

Type

Filter EG

Scale

Amplitude

Level / Pan

Amp EG

Scale

Element LFO

Element EQ

All Element

Osc

Balance

Copy or Exchange Elements

Normal Part (AWM2)

Drum Part

Normal Part (FM-X)

Common/Audio

■ In case of the Filter Type with “HPF Cutoff” and “HPF Cutoff/Key” parameters

The screenshot shows the 'Edit - Part1 - Element1' window. The 'Filter' section is expanded, showing 'Filter Type' set to 'LPF6+HPF12'. Below it, 'Cutoff' is 106 and 'Cutoff/Vel' is +0. The 'HPF Cutoff' is 0 and 'HPF Cutoff/Key' is +0%. The 'Center Key C3' is also visible. The 'Amplitude' section shows 'Gain' at 238. The bottom of the window shows tabs for 'Part 1', 'Common', 'Elem1', 'Elem2', 'Elem3', 'Elem4', 'Elem5', 'Elem6', 'Elem7', 'Elem8', 'All', 'Mute', and 'Solo'.

HPF Cutoff (High Pass Filter Cutoff Frequency)

Determines the central frequency for the Key Follow parameter (below) of the HPF. This parameter is available only when one of the filter types “LPF12+HPF12” or “LPF6+HPF12” is selected.

Settings: 0–255

HPF Cutoff/Key (High Pass Filter Cutoff Key Follow Sensitivity)

Determines the degree to which the notes (specifically, their position or Octave Range) affect the Cutoff Frequency of the HPF. This parameter is available only when one of the filter types “LPF12+HPF12” or “LPF6+HPF12” is selected.

Settings: -200% – +200%

Positive values: The Cutoff Frequency drops for lower notes and rises for higher notes.

Negative values: The Cutoff Frequency rises for lower notes and drops for higher notes.

Normal Part (AWM2) Edit

Common

Part Settings

General

Pitch

Zone Settings

Zone Transmit

Effect

Routing

Ins A

Ins B

EQ

Ins Assign

Arpeggio

Common

Individual

Advanced

Motion Seq

Common

Lane

Mod / Control

Part LFO

Control Assign

Receive SW

Element

Osc / Tune

Pitch EG

Filter

▶ Type

Filter EG

Scale

Amplitude

Level / Pan

Amp EG

Scale

Element LFO

Element EQ

All Element

Osc

Balance

Copy or Exchange
Elements

Filter EG

From the Filter EG display you can make all time and level settings for the Filter EG, which determine how the sound changes over time for Elements. These can be used to control the change the sound from the moment a note is pressed on the keyboard to the moment the sound stops.

Operation [PERFORMANCE (HOME)] → [EDIT] → Part selection → Element selection → [Filter] → [Filter EG]

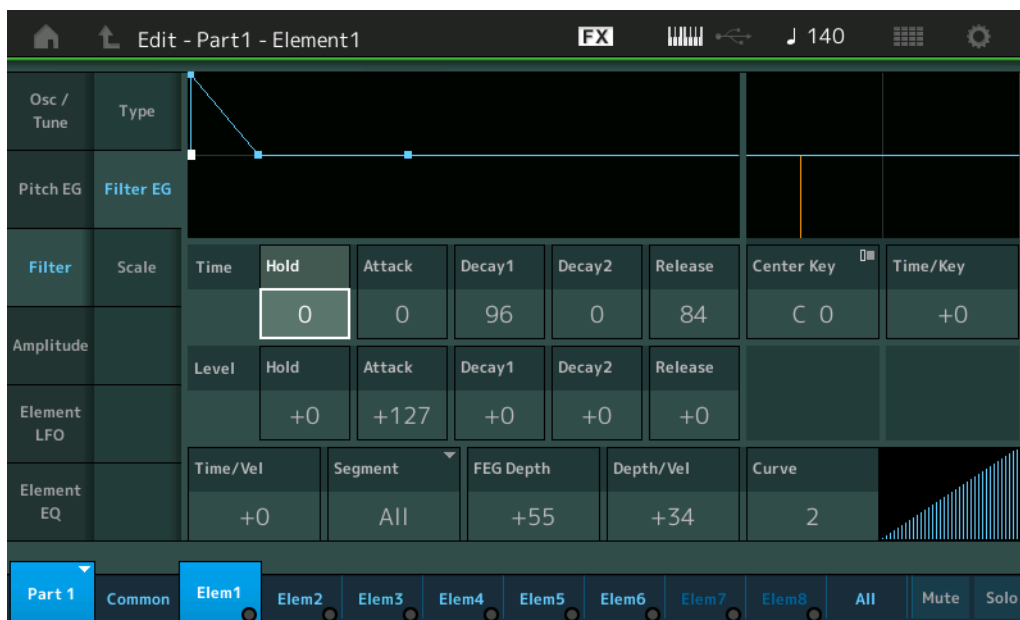

The full names of the available parameters are shown in the chart below, as they appear in the display.

	Hold	Attack	Decay1	Decay2	Release
Time	Hold Time	Attack Time	Decay1 Time	Decay2 Time	Release Time
Level	Hold Level	Attack Level	Decay1 Level	Decay2 Level	Release Level

Settings: Time: 0–127
Level: -128 – +127

Time/Key (FEG Time Key Follow Sensitivity)

Determines the degree to which the notes (specifically, their position or octave range) affect the Filter EG Times. The basic speed of change for the FEG is at the note specified in Center Key (below).

Settings: -64 – +63

Positive values: High notes result in a high FEG transition speed while low notes result in a slow speed.

Negative values: High notes result in a slow FEG transition speed while low notes result in a high speed.

0: The FEG transition speed does not change, regardless of the played note.

Center Key (FEG Time Key Follow Sensitivity Center Key)

Determines the central note for the “Time/Key” parameter above.

Settings: C-2–G8

Normal Part (AWM2) Edit

Common

Part Settings

General

Pitch

Zone Settings

Zone Transmit

Effect

Routing

Ins A

Ins B

EQ

Ins Assign

Arpeggio

Common

Individual

Advanced

Motion Seq

Common

Lane

Mod / Control

Part LFO

Control Assign

Receive SW

Element

Osc / Tune

Pitch EG

Filter

Type

Filter EG

Scale

Amplitude

Level / Pan

Amp EG

Scale

Element LFO

Element EQ

All Element

Osc

Balance

Copy or Exchange Elements

Time/Vel (FEG Time Velocity Sensitivity)

Segment (FEG Time Velocity Sensitivity Segment)

Determines how the FEG transition time (speed) responds to Velocity, or the strength with which the key is pressed. Select the "Segment," and then set its "Time/Vel" parameter.

Settings: Time/Vel: -64 – +63

Positive values: High Velocities result in a fast FEG transition speed while low Velocities result in a slow speed.

Negative values: High Velocities result in a slow FEG transition speed while low Velocities result in a fast speed.

0: The pitch transition speed does not change, regardless of the Velocity.

Settings: Segment: Attack, Atk+Dcy (Attack+Decay), Decay, Atk+Rls (Attack+Release), All

Attack: Time/Vel parameter affects Attack time.

Atk+Dcy: Time/Vel Value affects Attack/Decay1 time.

Decay: Time/Vel parameter affects Decay Time.

Atk+Rls: Time/Vel Value affects Attack/Release time.

All: Time/Vel affects all FEG Time parameters.

FEG Depth

Determines the Cutoff Frequency range for Filter EG.

Settings: -64 – +63

Depth/Vel (FEG Depth Velocity Sensitivity)

Curve (FEG Depth Velocity Sensitivity Curve)

Determines how the range of the Cutoff Frequency responds to Velocity (strength) with which you play notes on the keyboard. The Curve parameter lets you select from five different preset velocity curves (graphically indicated in the display) that determine how velocity affects the Filter EG Depth. In the illustrations below, the vertical axis indicates Cutoff Frequency Change and the horizontal axis indicates Velocity.

Settings: Depth/Vel: -64 – +63

Settings: Curve: 0–4



NOTE For details on FEG, see the Synthesizer Parameter Manual PDF document.

Normal Part (AWM2) Edit

Common

Part Settings

General

Pitch

Zone Settings

Zone Transmit

Effect

Routing

Ins A

Ins B

EQ

Ins Assign

Arpeggio

Common

Individual

Advanced

Motion Seq

Common

Lane

Mod / Control

Part LFO

Control Assign

Receive SW

Element

Osc / Tune

Pitch EG

Filter

Type

▶ Filter EG

Scale

Amplitude

Level / Pan

Amp EG

Scale

Element LFO

Element EQ

All Element

Osc

Balance

Copy or Exchange
Elements

Scale (Filter Scale)

From the Filter Scale display you can set parameters related to Filter Scale for Elements. "Filter Scale" controls the Filter Cutoff Frequency according to the positions of the notes on the keyboard.

Operation [PERFORMANCE (HOME)] → [EDIT] → Part selection → Element selection → [Filter] → [Scale]

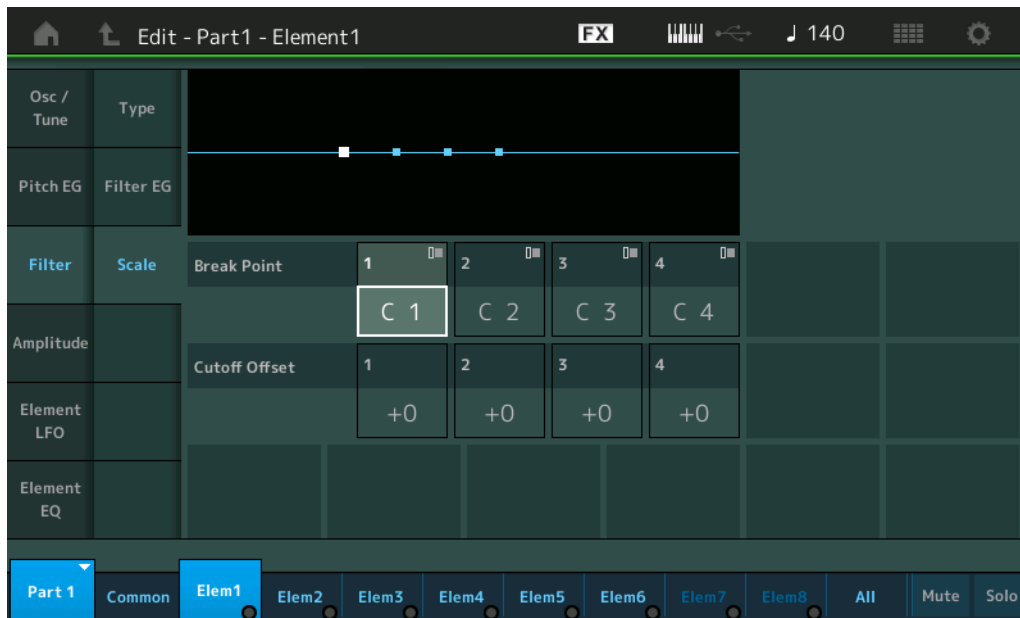

Break Point 1–4

Determines the four Break Points by specifying the respective note numbers.

Settings: C -2 – G8

NOTE Break Points 1 to 4 will be automatically be arranged in ascending order across the keyboard.

Cutoff Offset 1–4

Determines the offset value to the Cutoff Frequency at each Break Point.

Settings: -128 – +127

NOTE Regardless of the size of these Offsets, the minimum and maximum Cutoff limits (values of 0 and 127, respectively) cannot be exceeded.

NOTE Any note played below the Break Point 1 note results in the Break Point 1 Level setting. Likewise, any note played above the Break Point 4 note results in the Break Point 4 Level setting.

NOTE For information on setting examples for Filter Scaling, see the Synthesizer Parameter Manual PDF document.

Normal Part (AWM2) Edit

Common

Part Settings

General

Pitch

Zone Settings

Zone Transmit

Effect

Routing

Ins A

Ins B

EQ

Ins Assign

Arpeggio

Common

Individual

Advanced

Motion Seq

Common

Lane

Mod / Control

Part LFO

Control Assign

Receive SW

Element

Osc / Tune

Pitch EG

Filter

Type

Filter EG

▶ Scale

Amplitude

Level / Pan

Amp EG

Scale

Element LFO

Element EQ

All Element

Osc

Balance

Copy or Exchange Elements

Normal Part (AWM2)

Drum Part

Normal Part (FM-X)

Common/Audio

Amplitude

Level/Pan

From the Level/Pan display you can make Level and Pan settings for each individual Element.

Operation

[PERFORMANCE (HOME)] → [EDIT] → Part selection → Element selection → [Amplitude] → [Level/Pan]

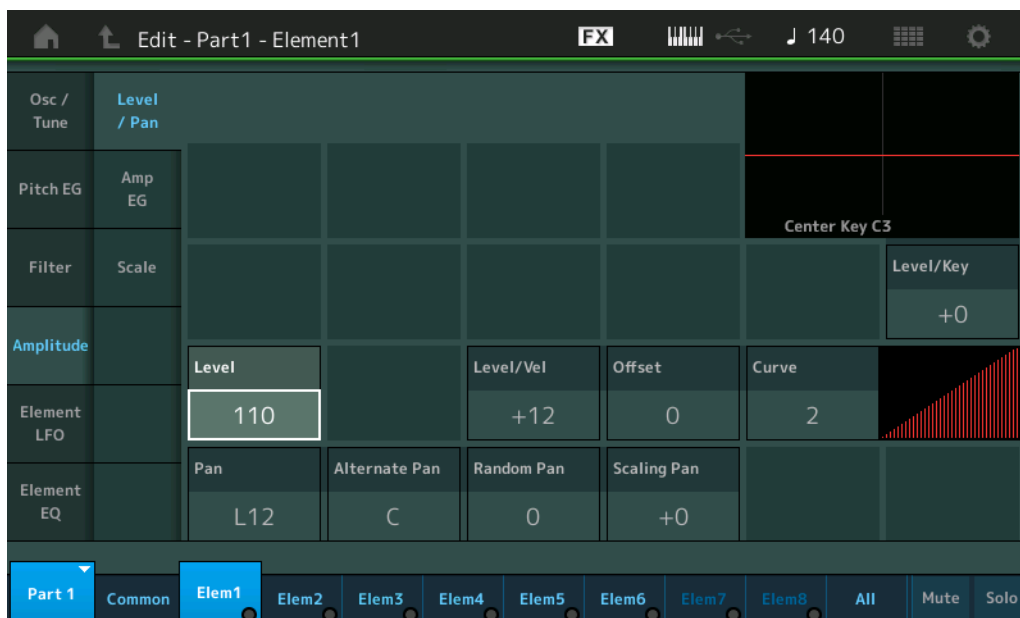

Level

Determines the output level of the Element.

Settings: 0–127

Level/Vel (Level Velocity Sensitivity)

Offset (Level Velocity Sensitivity Offset)

Curve (Level Velocity Sensitivity Curve)

Determines how the actual Velocity will be generated according to the Velocity (strength) with which you play notes on the keyboard. The Offset parameter raises or lowers the level specified by the “Level/Vel.” If the result is higher than 127, the velocity is set to 127. The Curve parameter lets you select from five different preset velocity curves (graphically indicated in the display) that determine how velocity affects the actual Velocity. In the illustrations below, the vertical axis indicates the actual resulting Velocity and the horizontal axis indicates Velocity with which you play notes.

Settings: Level/Vel: -64 – +63

Positive values: The more strongly you play the keyboard, the more the output rises.

Negative values: The more softly you play the keyboard, the more the output rises.

0: The output level does not change.

Settings: Offset: 0–127

Level Velocity Sensitivity Offset = 0

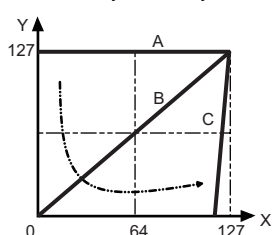

Level Velocity Sensitivity Offset = 64

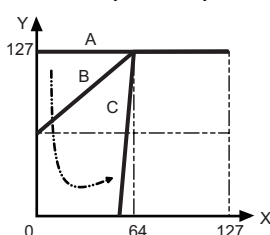

Level Velocity Sensitivity Offset = 96

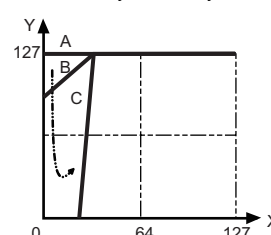

A: Level Velocity Sensitivity = 0

B: Level Velocity Sensitivity = 32

C: Level Velocity Sensitivity = 64

X: Velocity with which you play a note

Y: Actual resulting velocity (affecting the tone generator)

Normal Part (AWM2) Edit

Common

Part Settings

General

Pitch

Zone Settings

Zone Transmit

Effect

Routing

Ins A

Ins B

EQ

Ins Assign

Arpeggio

Common

Individual

Advanced

Motion Seq

Common

Lane

Mod / Control

Part LFO

Control Assign

Receive SW

Element

Osc / Tune

Pitch EG

Filter

Type

Filter EG

Scale

Amplitude

Level / Pan

Amp EG

Scale

Element LFO

Element EQ

All Element

Osc

Balance

Copy or Exchange Elements

Normal Part (AWM2)

Drum Part

Normal Part (FM-X)

Common/Audio

Settings: Curve: 0-4

0

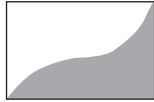

1

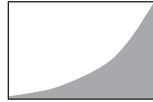

2



3

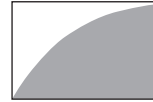

4

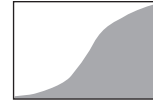
**Pan (Element Pan)**

Determines the stereo Pan position for the selected Element.

Settings: L63-C (center)-R63**Alternate Pan**

Determines the amount by which the sound is panned alternately left and right for each note you press. The Pan setting (above) is used as the basic Pan position.

Settings: L64-C-R63**Random Pan**

Determines the amount by which the sound of the selected Element is panned randomly left and right for each note you press. The Pan setting (above) is used as the Center Pan position.

Settings: 0-127**Scaling Pan**

Determines the degree to which the notes (specifically, their position or octave range) affect the Pan position, left and right, of the selected Element. At note C3, the main Pan setting (above) is used for the basic Pan position.

Settings: -64 - +0 - +63**Positive values:** Moves the pan position to the left for lower notes and to the right for higher notes.**Negative values:** Moves the pan position to the right for lower notes and to the left for higher notes.**Level/Key (Level Key Follow Sensitivity)**

Determines the degree to which the notes (specifically, their position or octave range) affect the volume of the selected Element. A Center Key setting of C3 is used as the basic setting.

Settings: -64 - +0 - +63**Positive values:** Lowers the output level for lower notes and raises it for higher notes.**Negative values:** Raises the output level for lower notes and lowers it for higher notes.**Center Key (Level Key Follow Sensitivity Center Key)**

This indicates that the central note for "Level/Key" above is C3. Keep in mind that this is for display purposes only; the value cannot be changed.

Normal Part (AWM2) Edit

Common

Part Settings

General

Pitch

Zone Settings

Zone Transmit

Effect

Routing

Ins A

Ins B

EQ

Ins Assign

Arpeggio

Common

Individual

Advanced

Motion Seq

Common

Lane

Mod / Control

Part LFO

Control Assign

Receive SW

Element

Osc / Tune

Pitch EG

Filter

Type

Filter EG

Scale

Amplitude

▶ Level / Pan

Amp EG

Scale

Element LFO

Element EQ

All Element

Osc

Balance

Copy or Exchange
Elements

Amp EG (Amplitude EG)

From the Amplitude EG display you can make all the time and level settings for the Amplitude EG, which determine how the volume of the sound changes over time. Using the AEG, you can control the transition in volume from the moment the sound starts to the moment the sound stops.

Operation

[PERFORMANCE (HOME)] → [EDIT] → Part selection → Element selection → [Amplitude] → [Amp EG]

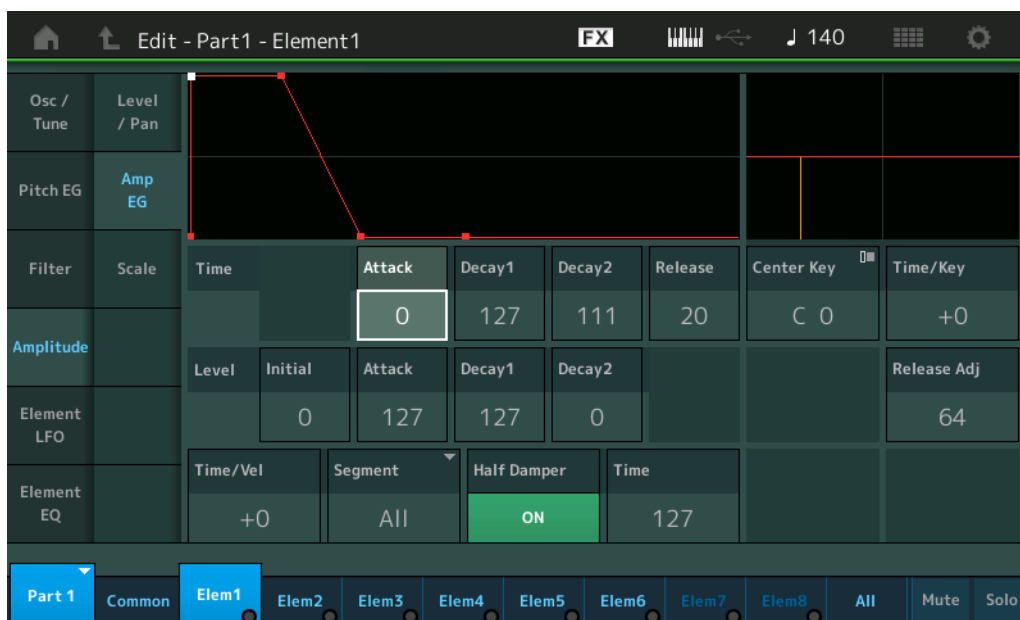

The full names of the available parameters are shown in the chart below, as they appear in the display.

	Initial	Attack	Decay1	Decay2	Release
Time	–	Attack Time	Decay1 Time	Decay2 Time	Release Time
Level	Initial Level	Attack Level	Decay1 Level	Decay2 Level	–

Settings: Time: 0–127

Level: 0–127

Time/Key (AEG Time Key Follow Sensitivity)

Determines the degree to which the notes (specifically, their position or octave range) affect the Amplitude EG Times. The Center Key parameter (below) is used as the basic amplitude for this parameter.

Settings: -64 – +63

Positive values: High notes result in a fast Amplitude EG transition speed while low notes result in a slow speed.

Negative values: High notes result in a slow Amplitude EG transition speed while low notes result in a fast speed.

0: The Amplitude EG transition speed does not change, regardless of the played note.

Center Key (AEG Time Key Follow Sensitivity Center Key)

Determines the central note for the “Time/Key” parameter above. When the Center Key note is played, the AEG behaves according to its actual settings.

Settings: C-2–G8

Release Adj (AEG Time Key Follow Sensitivity Center Key Release Adjustment)

Determines the sensitivity of AEG Time Key Follow Sensitivity to AEG Release. The lower the value, the lower the sensitivity.

Settings: 0–127

127: Sets the AEG Time Key Follow Sensitivity to the value of Decay 1 or Decay 2.

0: Produces no effect in the AEG Time Key Follow Sensitivity.

Normal Part (AWM2) Edit

Common

Part Settings

General

Pitch

Zone Settings

Zone Transmit

Effect

Routing

Ins A

Ins B

EQ

Ins Assign

Arpeggio

Common

Individual

Advanced

Motion Seq

Common

Lane

Mod / Control

Part LFO

Control Assign

Receive SW

Element

Osc / Tune

Pitch EG

Filter

Type

Filter EG

Scale

Amplitude

Level / Pan

▶ Amp EG

Scale

Element LFO

Element EQ

All Element

Osc

Balance

Copy or Exchange Elements

Time/Vel (AEG Time Velocity Sensitivity)

Segment (AEG Time Velocity Sensitivity Segment)

Determines how the AEG transition time (speed) responds to Velocity, or the strength with which the key is pressed. Select the "Segment," and then set its "Time/Vel" parameter.

Settings: Time/Vel: -64 – +63

Positive values: High Velocities result in a fast AEG transition speed while low Velocities result in a slow speed.

Negative values: High Velocities result in a slow AEG transition speed while low Velocities result in a fast speed.

0: The amplitude transition speed does not change, regardless of the Velocity.

Settings: Segment: Attack, Atk+Dcy (Attack+Decay), Decay, Atk+Rls (Attack+Release), All

Attack: Time/Vel parameter affects Attack Time.

Atk+Dcy: Time/Vel Value affects Attack/Decay1 Time.

Decay: Time/Vel parameter affects Decay Time.

Atk+Rls: Time/Vel Value affects Attack/Release Time.

All: Time/Vel affects all AEG Time parameters.

Half Damper (Half Damper Switch)

When the Half Damper Switch is set to on, you can produce a "half-pedal" effect just as on a real acoustic piano by using the optional FC3 Foot Controller connected to the FOOT SWITCH [SUSTAIN] jack on the rear panel.

Settings: off, on

Time (Half Damper Time)

Determines how quickly the sound decays to silence after the key is released while holding down the Foot Controller FC3 with the Half Damper Switch parameter turned on. This is not available when the Half Damper Switch is set to off.

Settings: 0–127

NOTE For details on AEG, see the Synthesizer Parameter Manual PDF document.

Normal Part (AWM2) Edit

Common

Part Settings

General

Pitch

Zone Settings

Zone Transmit

Effect

Routing

Ins A

Ins B

EQ

Ins Assign

Arpeggio

Common

Individual

Advanced

Motion Seq

Common

Lane

Mod / Control

Part LFO

Control Assign

Receive SW

Element

Osc / Tune

Pitch EG

Filter

Type

Filter EG

Scale

Amplitude

Level / Pan

▶ Amp EG

Scale

Element LFO

Element EQ

All Element

Osc

Balance

Copy or Exchange Elements

Normal Part (AWM2)

Drum Part

Normal Part (FM-X)

Common/Audio

Scale (Amplitude Scale)

From the Amplitude Scale display you can make Amplitude Scale settings for each Element. Amplitude Scale function controls the Amplitude output level according to the positions of the notes on the keyboard.

Operation [PERFORMANCE (HOME)] → [EDIT] → Part selection → Element selection → [Amplitude] → [Scale]

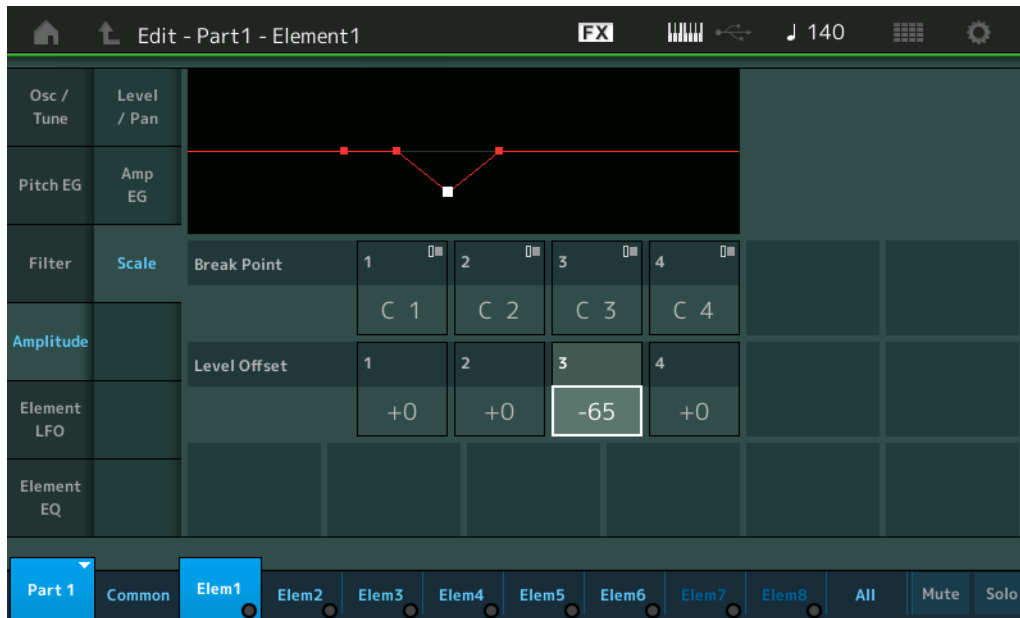

Break Point 1–4

Determines the four Amplitude Scale Break Points by specifying their respective note numbers.

Settings: C-2 – G8

NOTE Break Points 1 to 4 will be automatically be arranged in ascending order across the keyboard.

Level Offset 1–4

Determines the offset value of the level of each Amplitude Scale Break Point.

Settings: -128 – +127

NOTE For details on setting examples of the Amplitude Scaling, see the Synthesizer Parameter Manual PDF document.

Normal Part (AWM2) Edit

Common

Part Settings

General

Pitch

Zone Settings

Zone Transmit

Effect

Routing

Ins A

Ins B

EQ

Ins Assign

Arpeggio

Common

Individual

Advanced

Motion Seq

Common

Lane

Mod / Control

Part LFO

Control Assign

Receive SW

Element

Osc / Tune

Pitch EG

Filter

Type

Filter EG

Scale

Amplitude

Level / Pan

Amp EG

▶ Scale

Element LFO

Element EQ

All Element

Osc

Balance

Copy or Exchange Elements

Element LFO

From the Element LFO display you can make LFO related setting for each Element. The Low-Frequency Oscillator (LFO) unit of the Element generates a low frequency signal. The signal from the LFO can be used to modulate the pitch, filter, and amplitude.

Operation [PERFORMANCE (HOME)] → [EDIT] → Part selection → Element selection → [Element LFO]

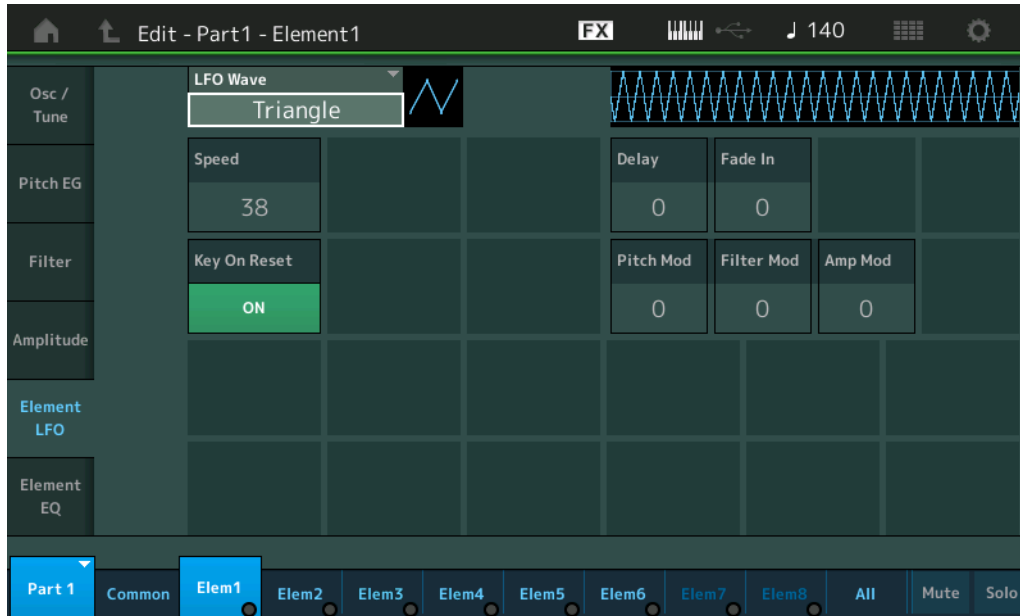

LFO Wave

Selects the LFO waveform that is used to vary the sound.

Settings: Saw, Triangle, Square

Saw (Sawtooth wave)

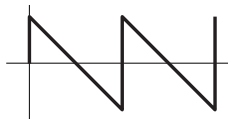

Triangle (Triangle wave)



Square (Square wave)

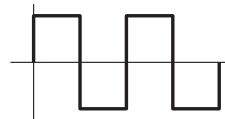

Speed (LFO Speed)

Adjusts the speed (frequency) of LFO variation. The larger the setting, the faster the speed.

Settings: 0-63

Key On Reset (LFO Key On Reset)

Determines whether or not the LFO is reset each time a note is played.

Settings: Off, On

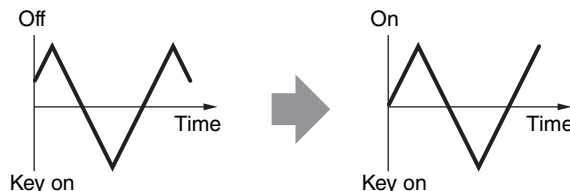

Delay (LFO Delay Time)

Determines the delay time between the moment that a Note On message is received and the moment the LFO comes into effect.

Settings: 0-127

Fade In (LFO Fade In Time)

Determines the amount of time for the LFO effect to fade in (after the "Delay" time has elapsed).

Settings: 0-127

Normal Part (AWM2) Edit

Common

Part Settings

General

Pitch

Zone Settings

Zone Transmit

Effect

Routing

Ins A

Ins B

EQ

Ins Assign

Arpeggio

Common

Individual

Advanced

Motion Seq

Common

Lane

Mod / Control

Part LFO

Control Assign

Receive SW

Element

Osc / Tune

Pitch EG

Filter

Type

Filter EG

Scale

Amplitude

Level / Pan

Amp EG

Scale

▶ Element LFO

Element EQ

All Element

Osc

Balance

Copy or Exchange Elements

Pitch Mod (LFO Pitch Modulation Depth)

Determines the amount (depth) by which the LFO waveform varies (modulates) the pitch of the sound.

Settings: 0–127

Filter Mod (LFO Filter Modulation Depth)

Determines the amount (depth) by which the LFO waveform varies (modulates) the Filter Cutoff frequency.

Settings: 0–127

Amp Mod (LFO Amplitude Modulation Depth)

Determines the amount (depth) by which the LFO waveform varies (modulates) the amplitude or volume of the sound.

Settings: 0–127

Element EQ

From the Element EQ display you can make EQ related settings for each Element.

Operation [PERFORMANCE (HOME)] → [EDIT] → Part selection → Element selection → [Element EQ]

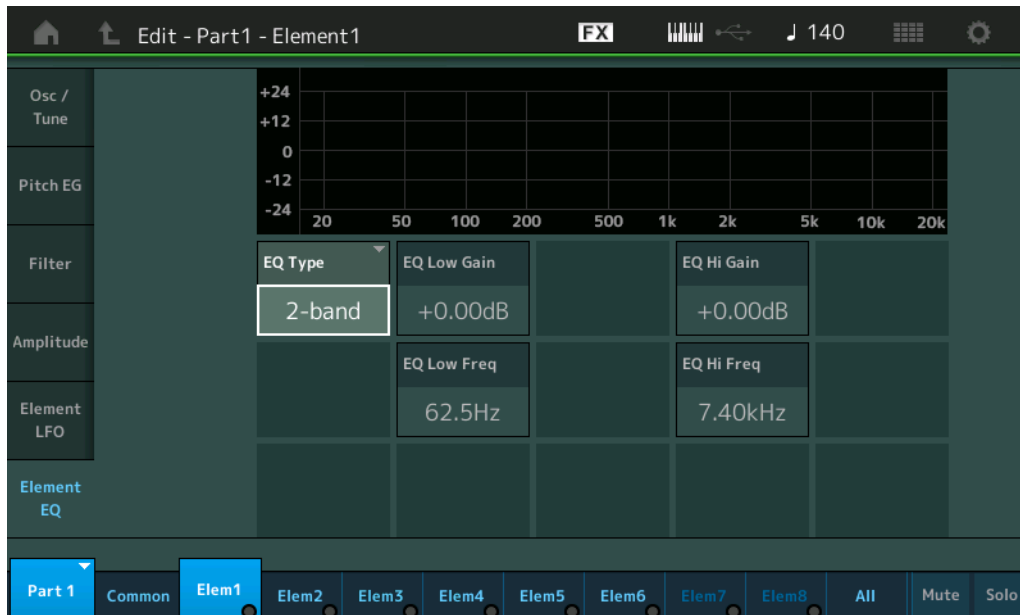

EQ Type (Element EQ Type)

Determines the Equalizer Type.

Settings: 2-band, P.EQ (Parametric EQ), Boost6 (boost 6dB), Boost12 (boost 12dB), Boost18 (boost 18dB), Thru

2-band: This is a “shelving” equalizer, which combines separate high and low frequency bands.

P.EQ: The Parametric EQ is used to attenuate or boost signal levels (gain) around the Frequency.

Boost6, Boost12, Boost18: These can be used to boost the level of the entire signal by 6dB, 12dB and 18dB, respectively

Thru: This setting bypasses the equalizers leaving the entire signal unaffected.

Normal Part (AWM2) Edit

Common

Part Settings

General

Pitch

Zone Settings

Zone Transmit

Effect

Routing

Ins A

Ins B

EQ

Ins Assign

Arpeggio

Common

Individual

Advanced

Motion Seq

Common

Lane

Mod / Control

Part LFO

Control Assign

Receive SW

Element

Osc / Tune

Pitch EG

Filter

Type

Filter EG

Scale

Amplitude

Level / Pan

Amp EG

Scale

▶ Element LFO

▶ Element EQ

All Element

Osc

Balance

Copy or Exchange Elements

Normal Part (AWM2)

Drum Part

Normal Part (FM-X)

Common/Audio

■ When “EQ Type” is set to “2-band”

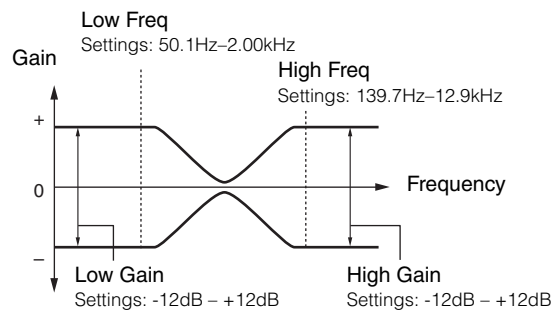

EQ Low Gain (Element EQ Low Gain)

Determines the level gain of the Low band.

Settings: -12dB – +12dB

EQ Hi Gain (Element EQ High Gain)

Determines the level gain of the High band.

Settings: -12dB – +12dB

EQ Low Freq (Element EQ Low Frequency)

Determines the frequency for the Low band.

Settings: 50.1Hz–2.00kHz

EQ Hi Freq (Element EQ High Frequency)

Determines the frequency for the High band.

Settings: 139.7Hz–12.9kHz

Normal Part (AWM2) Edit

Common

Part Settings

General

Pitch

Zone Settings

Zone Transmit

Effect

Routing

Ins A

Ins B

EQ

Ins Assign

Arpeggio

Common

Individual

Advanced

Motion Seq

Common

Lane

Mod / Control

Part LFO

Control Assign

Receive SW

Element

Osc / Tune

Pitch EG

Filter

Type

Filter EG

Scale

Amplitude

Level / Pan

Amp EG

Scale

Element LFO

▶ Element EQ

All Element

Osc

Balance

Copy or Exchange
Elements

Normal Part (AWM2)

Drum Part

Normal Part (FM-X)

Common/Audio

■ When “EQ Type” is set to “P.EQ”

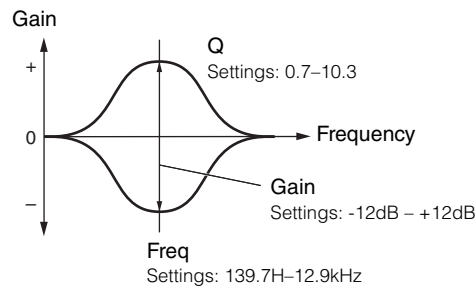

EQ Gain (Element EQ Gain)

Determines the level gain of the frequency set in “EQ Freq.”

Settings: -12dB – +12dB

EQ Freq (Element EQ Frequency)

Determines the frequency to be attenuated/boosted.

Settings: 139.7Hz–12.9kHz

EQ Q (Element EQ Q)

This varies the signal level at the Frequency setting to create various frequency curve characteristics.

Settings: 0.7–10.3

NOTE For details on EQ structure, see the Synthesizer Parameter Manual PDF document.

Normal Part (AWM2) Edit

Common

Part Settings

General

Pitch

Zone Settings

Zone Transmit

Effect

Routing

Ins A

Ins B

EQ

Ins Assign

Arpeggio

Common

Individual

Advanced

Motion Seq

Common

Lane

Mod / Control

Part LFO

Control Assign

Receive SW

Element

Osc / Tune

Pitch EG

Filter

Type

Filter EG

Scale

Amplitude

Level / Pan

Amp EG

Scale

Element LFO

▶ Element EQ

All Element

Osc

Balance

Copy or Exchange
Elements

Element All (All Element)

Osc (Oscillator)

From the Oscillator display you can set Oscillator-related parameters for the eight Elements.

Operation [PERFORMANCE (HOME)] → [EDIT] → Part selection → [All] → [Osc]

	SW	XA Control	Group	Waveform	Velocity Limit	Note Limit
Balance	1	Normal	1	NewAudioRec.wav	1 127	C -2 G 8
	2	A.SW Off	1	Grain3 St	1 127	C -2 G 8
	3	A.SW Off	1	Vocal Res	1 127	C -2 G 8
	4	Normal	1	Neo Seq Em All	1 127	C -2 G 8
	5	A.SW Off	1	JP Short Seq L	1 127	C -2 G 8
	6	A.SW2 On	1	Saturation	1 127	C -2 G 8
	7	Normal	1	JP Short Seq L	1 127	C -2 G 8
	8	Normal	1	Bubble	1 127	C -2 G 8

SW (Element Switch)

Determines whether each Element is active or not.

Settings: Off, On

XA Control

Determines the functioning of the Expanded Articulation (XA) feature of an Element.

The XA feature is sophisticated tone generator system that allows you to more effectively recreate realistic sound and natural performance techniques. It also provides other unique modes for random and alternate sound changes as you play. For details on the XA feature, see the “Tone Generator Block” in the “Basic Structure” on [page 6](#).

Settings: Normal, Legato, Key Off, Cycle, Random, A.SW1 On (Assignable Switch 1 ON), A.SW2 On (Assignable Switch 2 ON), A.SW Off (Assignable Switch 1 OFF)

Normal: The Element sounds normally each time you play the note.

Legato: When the Mono/Poly parameter is set to Mono, this Element will be played in place of the one which is set to “Normal” of the XA Control parameter when you play the keyboard in legato fashion (playing the next note of a single-note line or melody before releasing the previous note).

Key Off: The Element will sound each time you release the note.

Cycle: Each Element sounds alternately according to its numerical order. In other words, playing the first note will sound Element 1, the second note Element 2, and so on.

Random: Each Element will sound randomly each time you play the note.

A.SW1 On: When the [ASSIGN 1] button is turned On, the Element will sound.

A.SW2 On: When the [ASSIGN 2] button is turned On, the Element will sound.

A.SW Off: When both of the [ASSIGN 1] and [ASSIGN 2] buttons are turned Off, the Element will sound.

Group (Element Group)

Determines the group for XA Control. All Elements that have the same type of XA features must have the same group number. This setting does not apply when the XA Control parameters of all Elements are set to Normal.

Settings: 1–8

Waveform (Waveform Name)

Indicates the Waveform Name for each Element.

Settings: See the Data List PDF document.

Normal Part (AWM2) Edit

Common

Part Settings

General

Pitch

Zone Settings

Zone Transmit

Effect

Routing

Ins A

Ins B

EQ

Ins Assign

Arpeggio

Common

Individual

Advanced

Motion Seq

Common

Lane

Mod / Control

Part LFO

Control Assign

Receive SW

Element

Osc / Tune

Pitch EG

Filter

Type

Filter EG

Scale

Amplitude

Level / Pan

Amp EG

Scale

Element LFO

Element EQ

All Element

▶ Osc

Balance

Copy or Exchange Elements

Velocity Limit

Determines the minimum and maximum values of the velocity range within which each Element will respond. Each Element will only sound for notes played within its specified velocity range. If you first specify the maximum value and then the minimum value, for example “93 to 34,” then the Velocity range covers both “1 to 34” and “93 to 127.”

Settings: 1–127

Note Limit

Determines the lowest and highest notes of the keyboard range for each Element. Each Element will only sound for notes played within its specified range. If you first specify the highest note and then the lowest note, for example “C5 to C4,” then the note range covers both “C-2 to C4” and “C5 to G8.”

Settings: C-2 – G8

Balance

From the Balance display you can set parameters related to Level, Pitch, and Pan for the eight Elements.

Operation

[PERFORMANCE (HOME)] → [EDIT] → Part selection → [All] → [Balance]

Osc	SW	Coarse	Fine	Cutoff	Pan	Level
Balance	1	+0	+0	106	L12	110
	2	+0	+0	106	R12	98
	3	-12	+0	104	C	98
	4	+0	+0	106	C	63
	5	+0	+0	106	C	127
	6	+0	+0	106	C	100
	7	+0	+0	106	C	127
	8	+0	+0	106	C	113

SW (Element Switch)

Determines whether each Element is active or not.

Settings: Off, On

Coarse (Coarse Tune)

Determines the pitch of each Element in semitones.

Settings: -48 – +48

Fine (Fine Tune)

Determines the fine tuning for the pitch of each Element.

Settings: -64 – +63

Cutoff (Cutoff Frequency)

Determines the Cutoff Frequency for each Element.

Settings: 0–255

Pan (Element Pan)

Determines the stereo pan position for each Element.

Settings: L63 (far left)–C (center)–R63 (far right)

Level

Determines the level of each Element.

Settings: 0–127

Normal Part (AWM2) Edit

Common

Part Settings

General

Pitch

Zone Settings

Zone Transmit

Effect

Routing

Ins A

Ins B

EQ

Ins Assign

Arpeggio

Common

Individual

Advanced

Motion Seq

Common

Lane

Mod / Control

Part LFO

Control Assign

Receive SW

Element

Osc / Tune

Pitch EG

Filter

Type

Filter EG

Scale

Amplitude

Level / Pan

Amp EG

Scale

Element LFO

Element EQ

All Element

▶ Osc

▶ Balance

Copy or Exchange Elements

■ Copying or Exchanging Elements

You can copy or exchange between Elements.

Operation [PERFORMANCE (HOME)] → [EDIT] → Select Element to be copied → [SHIFT] + [EDIT]

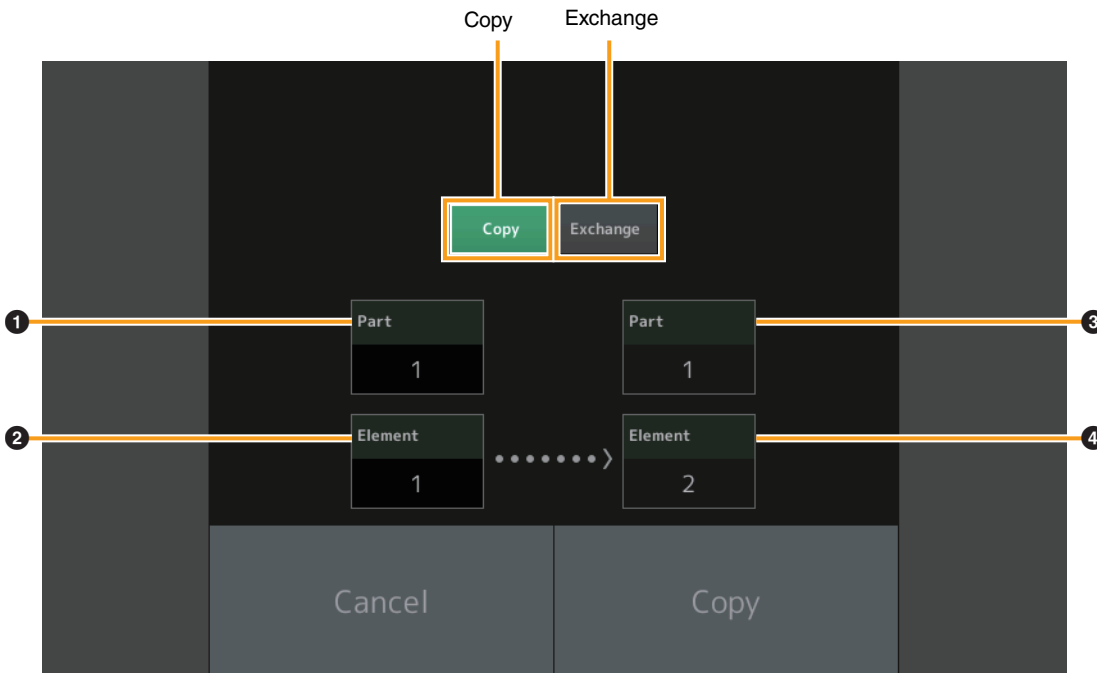

NOTE Copying or exchanging between different Part types (for example, between Elements and Operators) cannot be executed.

Copy

Touching this button activates the Copy function between Elements.

Exchange

Touching this button activates the Exchange function between Elements

① Part to be copied (or exchanged)

NOTE The currently selected Part is set automatically and this setting cannot be changed.

② Element to be copied (or exchanged)

③ Copy (or exchange) destination Part

④ Copy (or exchange) destination Element

Normal Part (AWM2) Edit

Common

Part Settings

General

Pitch

Zone Settings

Zone Transmit

Effect

Routing

Ins A

Ins B

EQ

Ins Assign

Arpeggio

Common

Individual

Advanced

Motion Seq

Common

Lane

Mod / Control

Part LFO

Control Assign

Receive SW

Element

Osc / Tune

Pitch EG

Filter

Type

Filter EG

Scale

Amplitude

Level / Pan

Amp EG

Scale

Element LFO

Element EQ

All Element

Osc

Balance

Copy or Exchange Elements

Drum Part Edit

Each Drum Part can consist of up to 73 Drum Keys, assigned to notes spread across the keyboard (C0 to C6). There are two types of Drum Part Edit displays: Key Common Edit display, for editing the settings that apply to all Drum keys; and Key Edit display, for editing individual keys. This section explains the parameters for Key Common Edit and Key Edit.

Key Common Edit (Common)

Part Settings

General

Operation

[PERFORMANCE (HOME)] → [EDIT] → Part selection → Drum Key [Common] → [Part Settings] → [General]

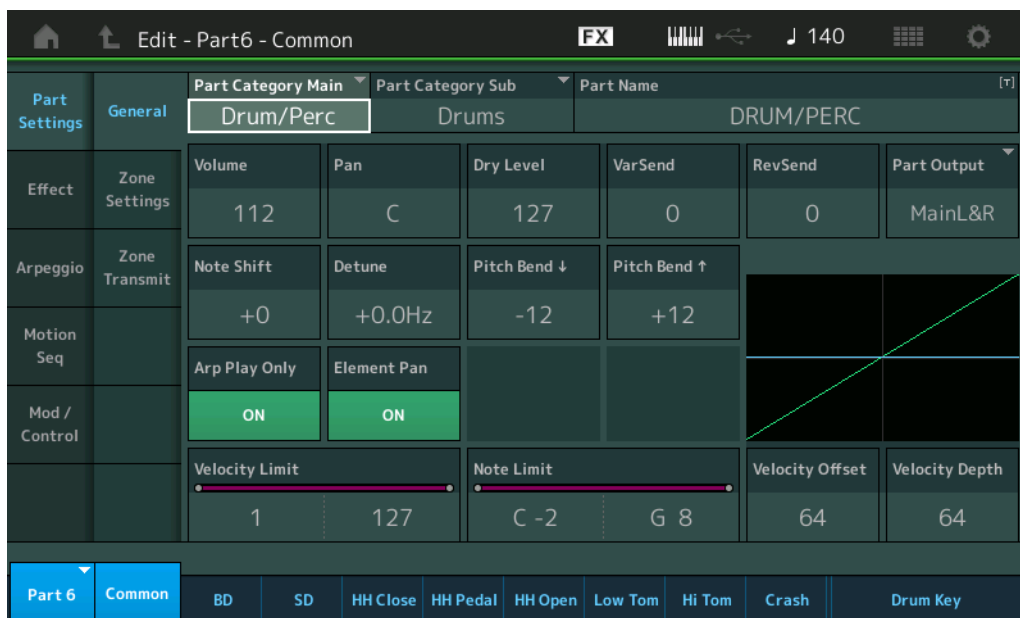

Part Category Main (Part Main Category)

Part Category Sub (Part Sub Category)

Determines the Main category and the Sub category for the selected Part.

Settings: See the Data List PDF document.

Part Name

Determines the Part name of the selected Part. Part names can contain up to 20 characters. Touching the parameter calls up the input character display.

Volume (Part Volume)

Determines the output level of the selected Part.

Settings: 0-127

Pan

Determines the stereo pan position of the selected Part.

Settings: L63-C-R63

Dry Level

Determines the dry sound level (not effect applied) of the selected Part. This is available only when "Part Output" is set to "MainL&R" or "Drum."

Settings: 0-127

Drum Part Edit

Common

Part Settings

General

Zone Settings

Zone Transmit

Effect

Routing

Ins A

Ins B

EQ

Ins Assign

Arpeggio

Common

Individual

Advanced

Motion Seq

Common

Lane

Mod / Control

Control Assign

Receive SW

Key

Osc / Tune

Filter

Level / Pan

Element EQ

Copying or Exchanging Drum Keys

Var Send (Variation Send)

Determines the level of the selected Part that is sent to the Variation effect. This is available only when “Part Output” is set to “MainL&R” or “Drum.”

Settings: 0–127

Rev Send (Reverb Send)

Determines the level of the selected Part that is sent to the Reverb effect. This is available only when “Part Output” is set to “MainL&R” or “Drum.”

Settings: 0–127

Part Output (Part Output Select)

Determines which audio output is used for the selected Part.

Settings: MainL&R, USB1&2...USB7&8, USB1...USB8, Off, Drum

MainL&R: Outputs in stereo (two channels) to the OUTPUT [L/MONO]/[R] jacks.

USB1&2...USB7&8: Outputs in stereo (Channels 1&2–7&8) to the [USB TO HOST] terminal.

USB1...USB8: Outputs in mono (Channels 1–8) to the [USB TO HOST] terminal.

Off: No audio signal for the Part is output.

Drum: “Drum Key Out” is displayed to determine the specific output for each Drum Key.

Note Shift

Determines the pitch (key transpose) setting for each Part in semitones.

Settings: -24 – +0 – +24

Detune

Determines the pitch settings of the selected Part in 0.1 Hz increments.

Settings: -12.8Hz – +0.0Hz – +12.7Hz

Pitch Bend \uparrow/\downarrow (Pitch Bend Range Upper/Lower)

Determines the maximum Pitch Bend Range in semitones.

Settings: -48 – +0 – +24

Arp Play Only (Arpeggio Play Only)

Determines whether or not the current Part plays only the note events of the Arpeggio playback. When this parameter is set to on, only the note events of the Arpeggio playback affect the tone generator block.

Settings: Off, On

Element Pan (Element Pan Switch)

Determines whether the individual pan settings for each Key Part (made via [EDIT] → Part selection → Drum Key selection → [Level/Pan] → “Pan”) are applied or not. When this is set to “off,” the pan position for the each Key is set to center in the Part.

Settings: Off, On

Velocity Limit

Determines the minimum and maximum values of the velocity range within which each Part will respond.

Settings: 1–127

Note Limit

Determines the lowest and highest notes of the keyboard range for each Part.

Settings: C -2 – G8

Drum Part Edit

Common

Part Settings

▶ General

Zone Settings

Zone Transmit

Effect

Routing

Ins A

Ins B

EQ

Ins Assign

Arpeggio

Common

Individual

Advanced

Motion Seq

Common

Lane

Mod / Control

Control Assign

Receive SW

Key

Osc / Tune

Filter

Level / Pan

Element EQ

Copying or Exchanging Drum Keys

Velocity Depth (Velocity Sensitivity Depth)

Determines the degree to which the resulting volume of the tone generator responds to your playing strength. The higher the value, the more the volume changes in response to your playing strength (as shown below).

Settings: 0–127

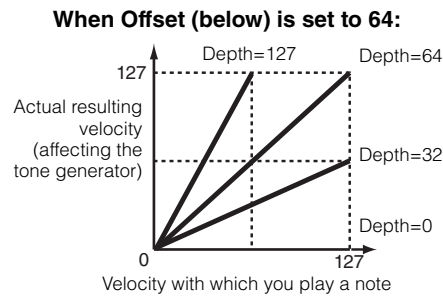

Velocity Offset (Velocity Sensitivity Offset)

Determines the amount by which played velocities are adjusted for the actual resulting velocity effect. This lets you raise or lower all velocities based on this setting value—allowing you to automatically compensate for playing too strongly or too softly.

Settings: 0–127

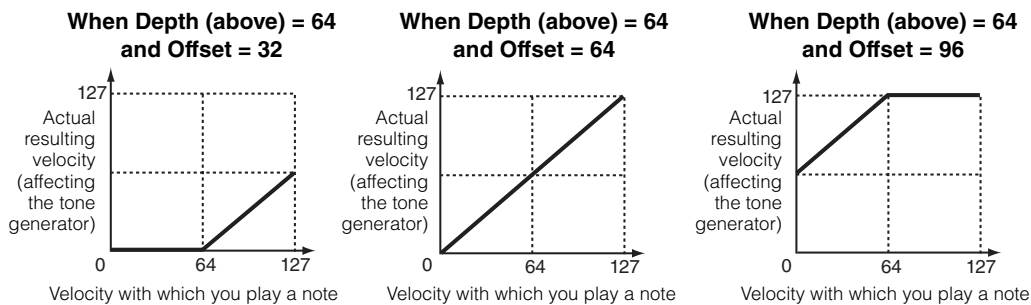

Zone Settings

Same as the Element Common Edit parameters for Normal Parts (AWM2) ([page 71](#)).

Zone Transmit

Same as the Element Common Edit parameters for Normal Parts (AWM2) ([page 73](#)).

Drum Part Edit

Common

Part Settings

- ▶ General
- ▶ Zone Settings
- ▶ Zone Transmit

Effect

- Routing
- Ins A
- Ins B
- EQ
- Ins Assign

Arpeggio

- Common
- Individual
- Advanced

Motion Seq

- Common
- Lane

Mod / Control

- Control Assign
- Receive SW

Key

- Osc / Tune
- Filter
- Level / Pan
- Element EQ

Copying or Exchanging Drum Keys

Effect

Routing

Operation

[PERFORMANCE (HOME)] → [EDIT] → Part selection → Drum Key [Common] → [Effect] → [Routing]

Drum Key Connection Switch

Insertion FX Switch

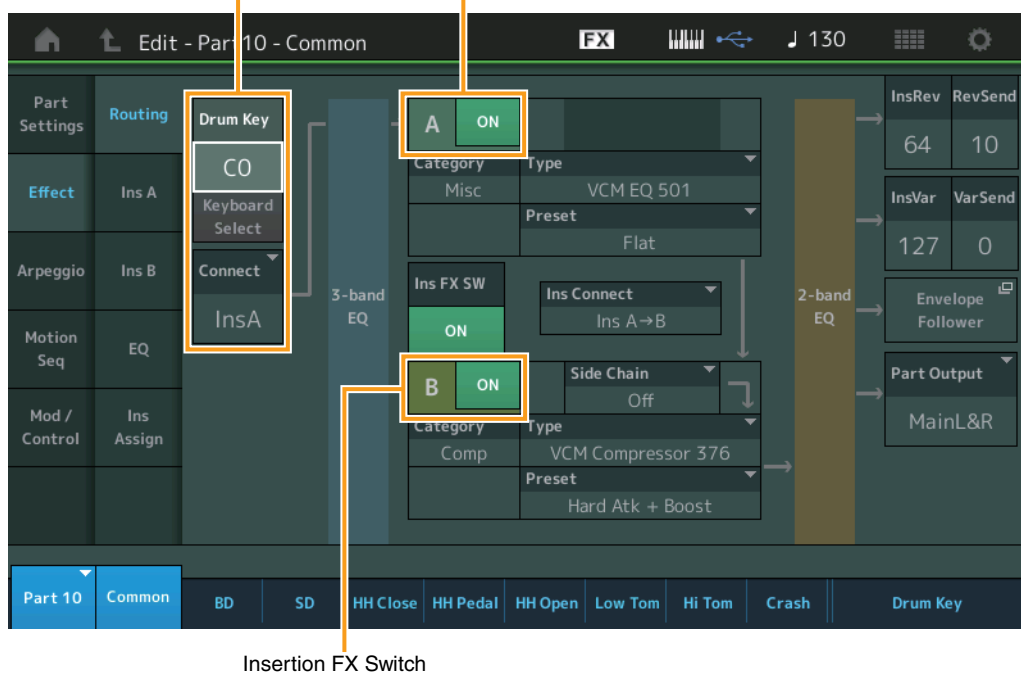

Insertion FX Switch

Drum Key Connection Switch

Determines which Insertion Effect (A or B) is used to process each individual Drum Key, and which is bypassed (Thru).

When the “Keyboard Select” is on, you can select Keys by playing the notes on the keyboard.

Settings: Thru, InsA (Insertion Effect A), InsB (Insertion Effect B)

Insertion FX Switch

Determines whether or not Insertion Effect A / Insertion Effect B is active or not.

Settings: Off, On

Category (Effect Category)

Type (Effect Type)

Determines the category and type for the selected effect.

Settings: For details on the editable Effect categories and types, see the Data List PDF document. Also, for details on the description for each Effect type, see the Synthesizer Parameter Manual PDF document.

Preset

Allows you to call up pre-programmed settings for each Effect type, designed to be used for specific applications and situations.

Settings: For a list of all Preset Performances, see the Data List PDF document.

Side Chain/Modulator (Side Chain/Modulator Part)

Determine the Part used for the Side Chain/Modulator. This is not available depending on the selected Effect Type. For details on the Side Chain/Modulator, see the Routing display (page 76) of the Normal Part (AWM2).

Settings: Part 1–16, A/D, Master, Off

Drum Part Edit

Common

Part Settings

General

Zone Settings

Zone Transmit

Effect

Routing

Ins A

Ins B

EQ

Ins Assign

Arpeggio

Common

Individual

Advanced

Motion Seq

Common

Lane

Mod / Control

Control Assign

Receive SW

Key

Osc / Tune

Filter

Level / Pan

Element EQ

Copying or Exchanging Drum Keys

Normal Part (AWM2)

Drum Part

Normal Part (FM-X)

Common/Audio

Ins Connect (Insertion Connection Type)

Determines the effect routing for Insertion Effects A and B.

Settings: Parallel, Ins A→B, Ins B→A

RevSend (Reverb Send)

VarSend (Variation Send)

Determines the Send level of the signal sent from Insertion Effect A/B (or the bypassed signal) to the Reverb/Variation effect. This is active only when the Part Output/Drum Key Output is set to “MainL&R.”

Settings: 0–127

Part Output (Part Output Select)

Determines the specific output for the audio signal.

Settings: MainL&R, USB1&2...USB7&8, USB1...USB8, Off, Drum

MainL&R: Outputs in stereo (two channels) to the OUTPUT [L/MONO]/[R] jacks.

USB1&2...USB7&8: Outputs in stereo (Channels 1&2–7&8) to the [USB TO HOST] terminal.

USB1...USB8: Outputs in mono (Channels 1–8) to the [USB TO HOST] terminal.

Off: No audio signal for the Part is output.

Drum: “Drum Key Out” is displayed to determine the specific output for each Drum Key.

Envelope Follower

Calls up the Envelope Follower Setting display.

Refer to the Routing display ([page 76](#)) for Normal Parts (AWM2).

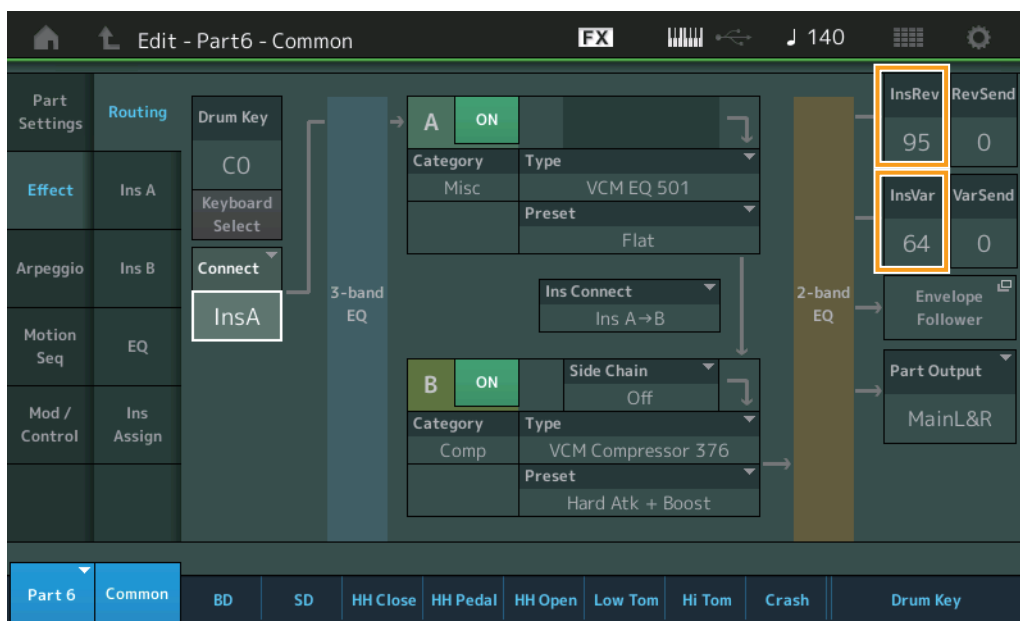

InsRev (Insertion Reverb Send)

InsVar (Insertion Variation Send)

Determines the Send level for the entire Drum Part (all keys), sent from Insertion Effect A/B to the Reverb/Variation effect.

This is active only when the Drum Key Connection Switch is set to “InsA” or “InsB” and the Part Output/Drum Key Output is set to “MainL&R.”

Settings: 0–127

Drum Part Edit

Common

Part Settings

General

Zone Settings

Zone Transmit

Effect

Routing

Ins A

Ins B

EQ

Ins Assign

Arpeggio

Common

Individual

Advanced

Motion Seq

Common

Lane

Mod / Control

Control Assign

Receive SW

Key

Osc / Tune

Filter

Level / Pan

Element EQ

Copying or Exchanging Drum Keys

Normal Part (AWM2)

Drum Part

Normal Part (FM-X)

Common/Audio

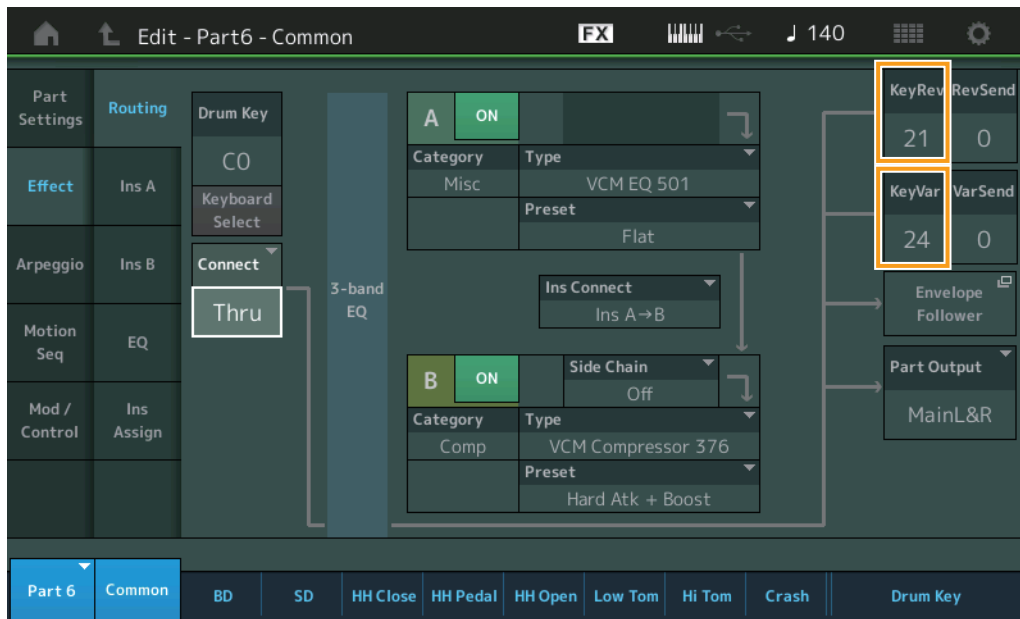

KeyRev (Drum Key Reverb Send) KeyVar (Drum Key Variation Send)

Determines the Send level for each Drum Key, sent from Insertion Effect A/B to the Reverb/Variation effect. This is active only when the Drum Key Connection Switch is set to "Thru" and the Part Output/Drum Key Output is set to "MainL&R."

Settings: 0–127

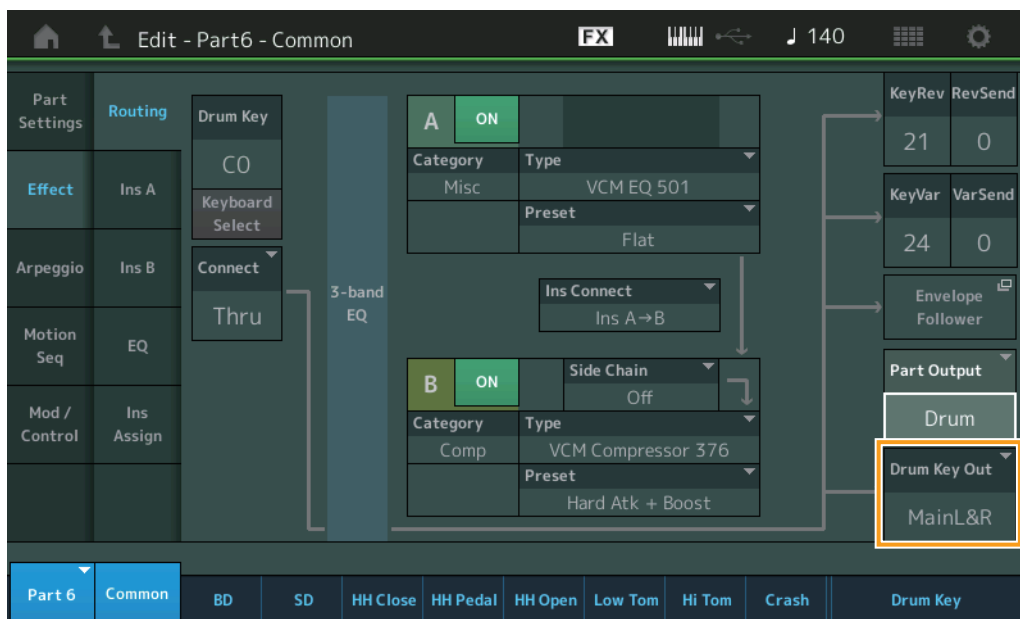

Drum Key Out (Drum Key Output Select)

Determines the specific output for the individual Drum Key. This is displayed only when the Part Output is set to "Drum."

Settings: MainL&R, USB1&2...USB7&8, USB1...USB8

MainL&R: Outputs in stereo (two channels) to the OUTPUT [L/MONO]/[R] jacks.

USB1&2...USB7&8: Outputs in stereo (Channels 1&2–7&8) to the [USB TO HOST] terminal.

USB1...USB8: Outputs in mono (Channels 1–8) to the [USB TO HOST] terminal.

NOTE When the Drum Key Connection Switch is set to "InsA" or "InsB," this parameter is fixed to "MainL&R."

Drum Part Edit

Common

Part Settings

General

Zone Settings

Zone Transmit

Effect

Routing

Ins A

Ins B

EQ

Ins Assign

Arpeggio

Common

Individual

Advanced

Motion Seq

Common

Lane

Mod / Control

Control Assign

Receive SW

Key

Osc / Tune

Filter

Level / Pan

Element EQ

Copying or Exchanging Drum Keys

Ins A (Insertion Effect A) Ins B (Insertion Effect B)

Same as the Element Common Edit parameters for Normal Parts (AWM2) ([page 77](#)).

EQ (Part Equalizer)

Same as the Element Common Edit parameters for Normal Parts (AWM2) ([page 78](#)).

Ins Assign (Insertion Assign)

Same as the Element Common Edit parameters for Normal Parts (AWM2) ([page 81](#)).

Arpeggio

Common

Same as the Element Common Edit parameters for Normal Parts (AWM2) ([page 82](#)).

Individual

Same as the Element Common Edit parameters for Normal Parts (AWM2) ([page 85](#)).

Advanced

Same as the Element Common Edit parameters for Normal Parts (AWM2) ([page 87](#)), except for the additional parameter below.

Fixed SD/BD

When this parameter is set to On, C1 will be used as the note of the Bass Drum and D1 will be used as the note of the Snare Drum in Arpeggio playback.

Settings: Off, On

Motion Seq (Motion Sequencer)

Common

Same as the Element Common Edit parameters for Normal Parts (AWM2) ([page 88](#)).

Lane

Same as the Element Common Edit parameters for Normal Parts (AWM2) ([page 91](#)).

Mod/Control (Modulation/Control)

Control Assign

Same as the Element Common Edit parameters for Normal Parts (AWM2) ([page 100](#)), except for the different setting values in the Destination parameter. For the setting value for "Destination," see the "Control List" in the Data List PDF document.

Receive SW (Receive Switch)

Same as the Element Common Edit parameters for Normal Parts (AWM2) ([page 105](#)).

Drum Part Edit

Common

Part Settings

General

Zone Settings

Zone Transmit

Effect

Routing

- ▶ Ins A
- ▶ Ins B
- ▶ EQ
- ▶ Ins Assign

▶ Arpeggio

- ▶ Common
- ▶ Individual
- ▶ Advanced

▶ Motion Seq

- ▶ Common
- ▶ Lane

▶ Mod / Control

- ▶ Control Assign
- ▶ Receive SW

Key

Osc / Tune

Filter

Level / Pan

Element EQ

Copying or Exchanging Drum Keys

Key Edit (Key)

Osc/Tune (Oscillator/Tune)

From the Oscillator/Tune display you can set Oscillator-related parameters for each Key of the Drum Part.

Operation [PERFORMANCE (HOME)] → [EDIT] → Part selection → Key selection → [Osc/Tune]

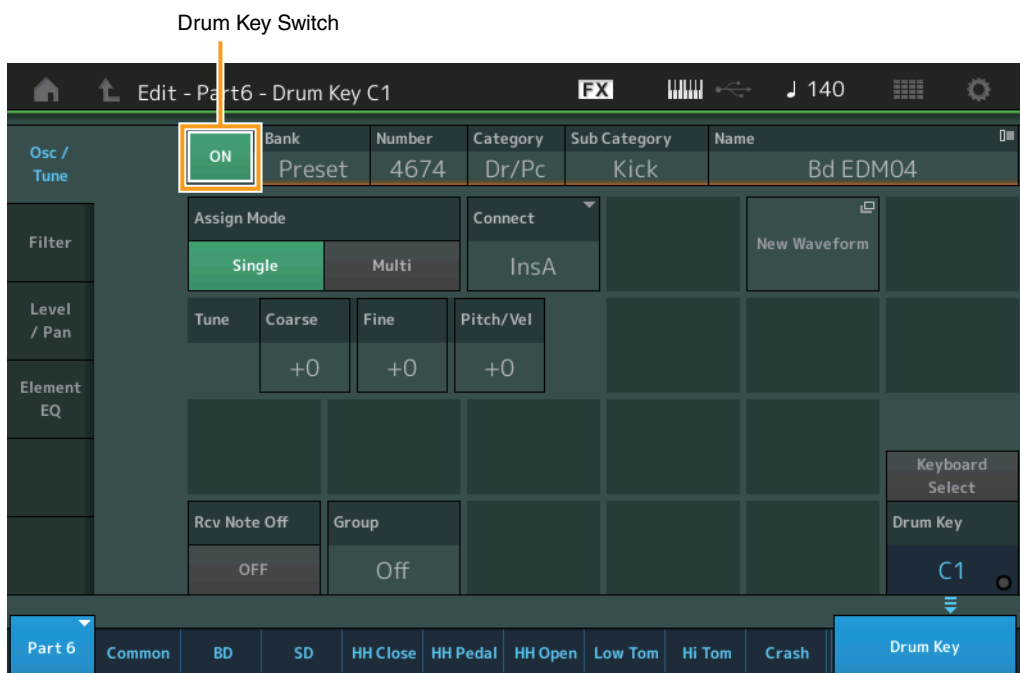

Bank (Waveform Bank)

Number (Waveform Number)

Category (Waveform Category)

Sub Category (Waveform Sub Category)

Name (Waveform Name)

Indicates the information of the waveform used for the selected Drum Key. "Bank" indicates which waveform location (Preset, User and Library) is assigned to the Key.

Settings: Refer to the Data List PDF document.

Drum Key Switch

Determines whether the currently selected Drum Key is used or not.

Settings: Off, On

Assign Mode (Key Assign Mode)

Determines the playing method when the same notes are received continuously, and without corresponding note off messages.

Settings: Single, Multi

Single: Double or repeated playback of the same note is not possible. The first note will be stopped, then the next note will be sounded.

Multi: All notes are sounded simultaneously. This allows playback of the same note when it is played multiple times in succession (especially for tambourine and cymbal sounds that you would want to ring out to their full decay).

Connect (Drum Key Connection Switch)

Determines which Insertion Effect (A or B) is used to process each individual Drum Key. The Insertion Effect is bypassed if "Thru" is selected. This parameter is same as the "Connect" parameter in the "Routing" display of Effect settings in Key Common Edit. Making a setting here automatically changes the setting of that parameter as well.

Settings: Thru, InsA (Insertion Effect A), InsB (Insertion Effect B)

Drum Part Edit

Common

Part Settings

General

Zone Settings

Zone Transmit

Effect

Routing

Ins A

Ins B

EQ

Ins Assign

Arpeggio

Common

Individual

Advanced

Motion Seq

Common

Lane

Mod / Control

Control Assign

Receive SW

Key

▶ Osc / Tune

Filter

Level / Pan

Element EQ

Copying or Exchanging Drum Keys

New Waveform

Loads Audio data stored in the USB flash drive as “Waveform.” For details on loading, see “Load” ([page 198](#)).

After the Waveform is loaded, the Edit Waveform parameter will be available. For details on “Edit Waveform,” see [page 109](#).

Coarse (Coarse Tune)

Determines the pitch of each Drum Key Wave in semitones.

Settings: -48 – +48

Fine (Fine Tune)

Determines the fine tuning for the pitch of each Drum Key Wave.

Settings: -64 – 63

Pitch/Vel (Pitch Velocity Sensitivity)

Determines how the pitch of the selected Drum key responds to velocity.

Settings: -64 – 63

Positive values: The harder you play the keyboard, the more the pitch rises.

Negative values: The harder you play the keyboard, the more the pitch falls.

0: No change in pitch.

Rcv Note Off (Receive Note Off)

Select whether MIDI Note Off messages are received by each Drum Key.

Settings: off, on

Group (Alternate Group)

Set the Alternate Group to which the key is assigned. The Parts to which the same number is assigned here cannot sound simultaneously. This setting helps to reproduce the sounds of a real drum kit, in which some drum sounds cannot physically be played simultaneously, such as open and closed hi-hats.

Settings: off, 1–127

KeyRev (Drum Key Reverb Send)

KeyVar (Drum Key Variation Send)

Determines the level of the Drum key sound (the bypassed signal) that is sent to Reverb/Variation effect. This is not available depending on the setting of the Drum Key Connection Switch.

Settings: 0–127

Drum Key Out (Drum Key Output Select)

Determines the specific output for the individual Drum Key.

This is not available depending on the settings of Drum Key Connection Switch or Part Output.

Settings: MainL&R, USB1&2...USB7&8, USB1...USB8

MainL&R: Outputs in stereo (two channels) to the OUTPUT [L/MONO]/[R] jacks.

USB1&2...USB7&8: Outputs in stereo (Channels 1&2–7&8) to the [USB TO HOST] terminal.

USB1...USB8: Outputs in mono (Channels 1–8) to the [USB TO HOST] terminal.

Keyboard Select (Keyboard Select Switch)

Determines whether or not the Keyboard Select setting is active or not. When this is set to on, you can select Drum Keys by playing the notes on the keyboard.

Settings: Off, On

Drum Key

Indicates the selected Drum key.

Settings: C0–C6

Drum Part Edit

Common

Part Settings

General

Zone Settings

Zone Transmit

Effect

Routing

Ins A

Ins B

EQ

Ins Assign

Arpeggio

Common

Individual

Advanced

Motion Seq

Common

Lane

Mod / Control

Control Assign

Receive SW

Key

▶ Osc / Tune

Filter

Level / Pan

Element EQ

Copying or Exchanging Drum Keys

Filter

From the Filter display you can apply filter settings to the Drum Part. These let you apply a low pass filter and high pass filter to each individual Drum key.

Operation [PERFORMANCE (HOME)] → [EDIT] → Part selection → Key selection → [Filter]

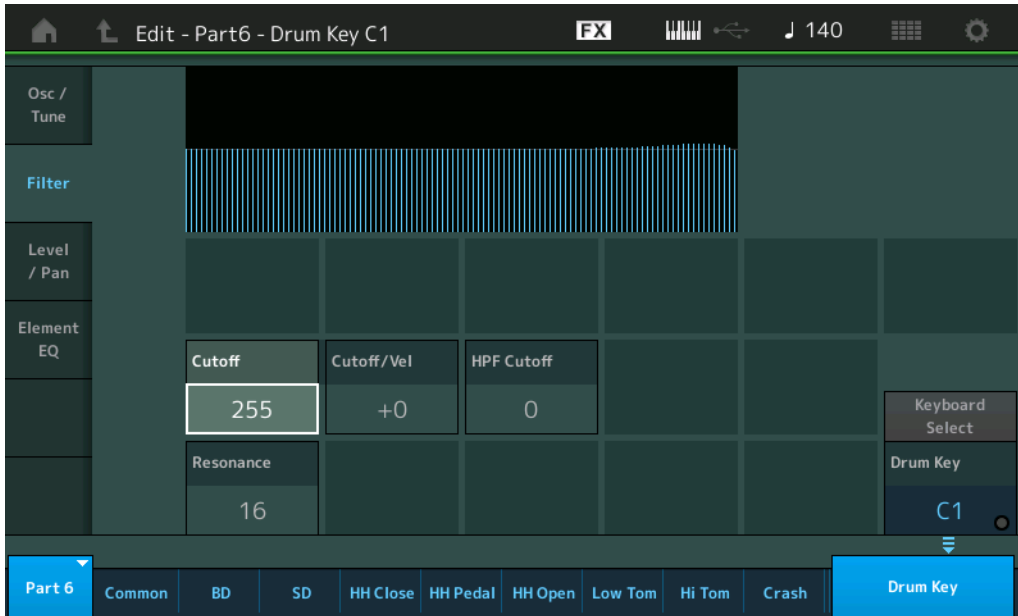

Cutoff (Low Pass Filter Cutoff Frequency)

Use this parameter to set the cutoff frequency for the low-pass filter.

Settings: 0–255

Cutoff/Vel (Low Pass Filter Cutoff Velocity Sensitivity)

Set the velocity sensitivity of the Low Pass Filter Cutoff frequency. Positive settings will cause the Cutoff Frequency to rise the harder you play the keyboard. A negative setting will have the opposite effect.

Settings: -64 – +63

Resonance (Low Pass Filter Resonance)

Determines the amount of Resonance (harmonic emphasis) applied to the signal at the Cutoff Frequency.

Settings: 0–127

HPF Cutoff (High Pass Filter Cutoff Frequency)

Determines the Cutoff frequency of the High Pass Filter.

Settings: 0–255

Drum Part Edit

Common

Part Settings

General

Zone Settings

Zone Transmit

Effect

Routing

Ins A

Ins B

EQ

Ins Assign

Arpeggio

Common

Individual

Advanced

Motion Seq

Common

Lane

Mod / Control

Control Assign

Receive SW

Key

Osc / Tune

▶ Filter

Level / Pan

Element EQ

Copying or Exchanging Drum Keys

Level/Pan

From the Level/Pan display you can make Level and Pan settings for each Drum Key.

Operation

[PERFORMANCE (HOME)] → [EDIT] → Part selection → Key selection → [Level/Pan]

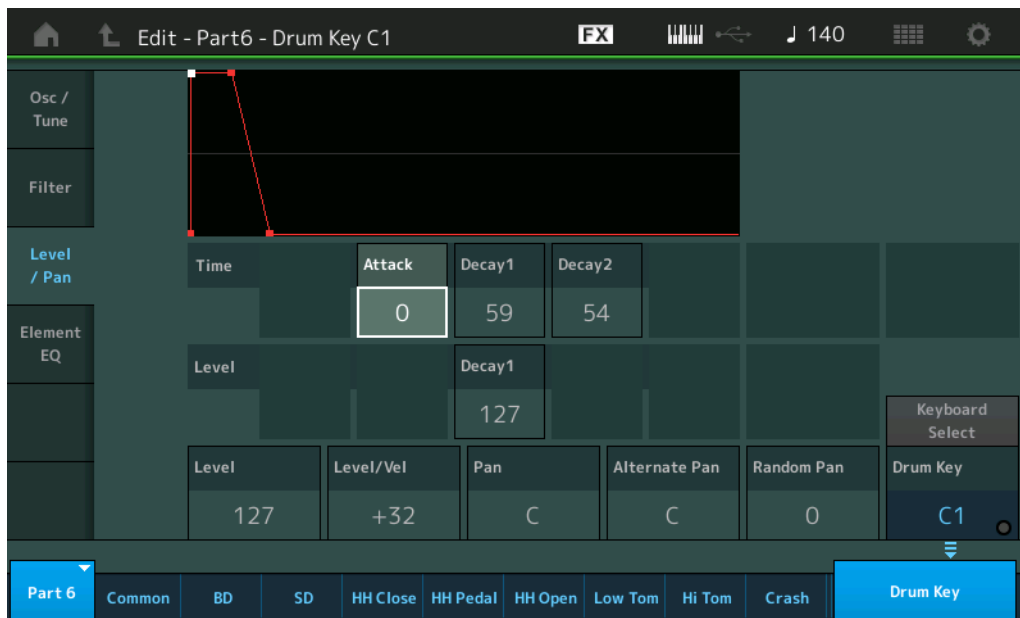

The full names of the available parameters are shown in the chart below, as they appear in the display.

	Attack	Decay1	Decay2
Time	Attack Time	Decay1 Time	Decay2 Time
Level	–	Decay1 Level	–

Settings: Time: 0–127, Hold (only for Decay2)

Level: 0–127

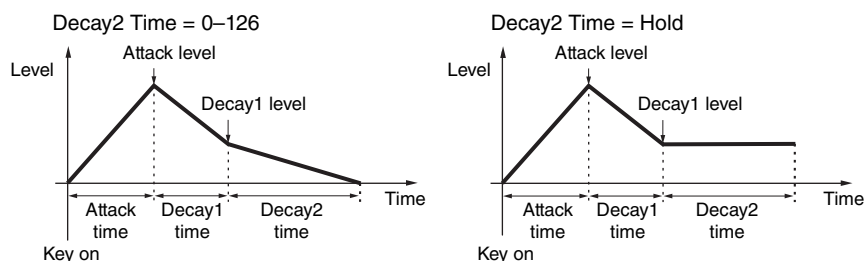

Level

Determines the output level of the Drum Key. This lets you make detailed balance adjustments among the various sounds of the Drum Key.

Settings: 0–127

Level/Vel (Level Velocity Sensitivity)

Determines how the output level of the Drum Key responds to Velocity.

Settings: -64 – +63

Positive values: The more strongly you play the keyboard, the more the output rises.

Negative values: The more softly you play the keyboard, the more the output rises.

0: The output level does not change.

Pan

Sets the pan position (stereo position) of each Drum Key. This will also be used as the basic Pan position for the Alternate and Random settings.

Settings: L63 (far left)–C (center)–R63 (far right)

Drum Part Edit

Common

Part Settings

General

Zone Settings

Zone Transmit

Effect

Routing

Ins A

Ins B

EQ

Ins Assign

Arpeggio

Common

Individual

Advanced

Motion Seq

Common

Lane

Mod / Control

Control Assign

Receive SW

Key

Osc / Tune

Filter

▶ Level / Pan

Element EQ

Copying or Exchanging Drum Keys

Normal Part (AWM2)

Drum Part

Normal Part (FM-X)

Common/Audio

Alternate Pan

Determines the amount by which the sound of the selected Drum key is panned alternately left and right for each note you press. The Pan setting (above) is used as the basic Pan position.

Settings: L64–C–R63

Random Pan

Determines the amount by which the sound of the selected Drum Key is panned randomly left and right for each note you press. The Pan setting (above) is used as the Center Pan position.

Settings: 0–127

Element EQ

Same as the Element Edit parameters for Normal Parts (AWM2) ([page 127](#)).

■ Copying or Exchanging Drum Keys

Same as “Copying or Exchanging Elements” for Normal Parts (AWM2) ([page 132](#)).

Drum Part Edit**Common****Part Settings**

General

Zone Settings

Zone Transmit

Effect

Routing

Ins A

Ins B

EQ

Ins Assign

Arpeggio

Common

Individual

Advanced

Motion Seq

Common

Lane

Mod / Control

Control Assign

Receive SW

Key

Osc / Tune

Filter

▶ Level / Pan

▶ Element EQ

Copying or Exchanging Drum Keys

Normal Part (FM-X) Edit

A Normal Part (FM-X) can consist of up to eight Operators. There are two types of Normal Part (FM-X) Edit displays: Operator Common Edit display, for editing settings common to all eight Operators; and Operator Edit display, for editing individual Operators.

Operator Common Edit (Common)

Part Settings

General

From the General display you can set various parameters such as Part Name, Volume, and Pan.

Operation

[PERFORMANCE (HOME)] → [EDIT] → Part selection → Operator [Common] → [Part Settings] → [General]

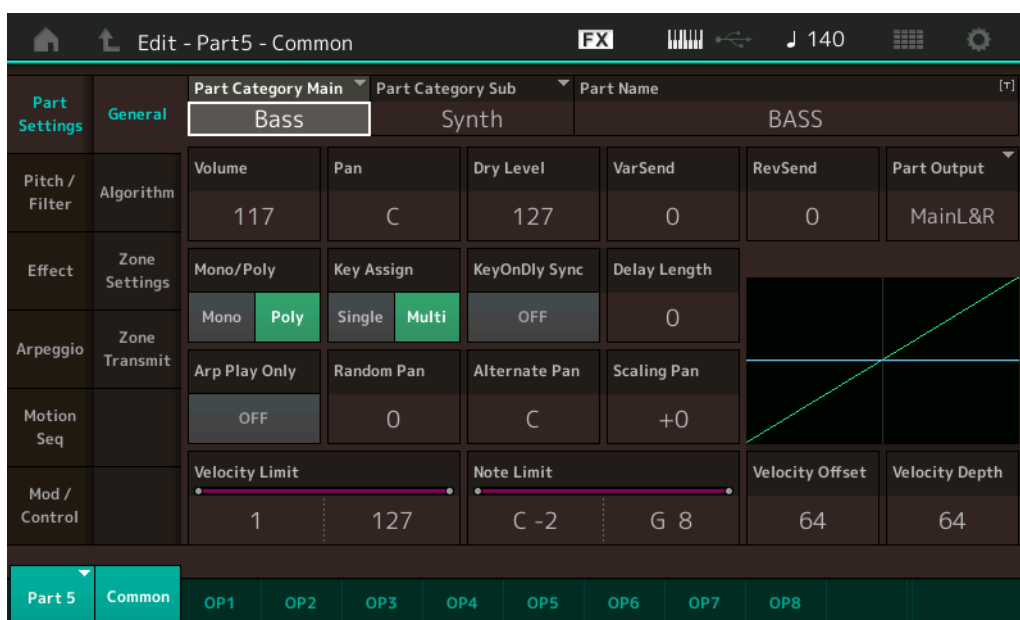

Most parameters are the same as parameters on the Element Common Edit display for Normal Parts (AWM2) (page 66) except the following additional parameters as follows.

Random Pan

Determines the amount by which the sound of the selected Operator is panned randomly left and right for each note you press. The Pan setting is used as the Center Pan position.

Settings: 0-127

Alternate Pan

Determines the amount by which the sound of the selected Operator is panned alternately left and right for each note you press. The Pan setting is used as the basic Pan position.

Settings: L64-C-R63

Scaling Pan

Determines the degree to which the notes (specifically, their position or octave range) affect the Pan position, left and right, of the selected Operator. At note C3, the main Pan setting is used for the basic Pan position. Positive settings will cause the Pan position to be set left when you play in the lower range on the keyboard and to be set right when you play in the higher range on the keyboard. A negative setting will have the opposite effect.

Settings: -64 - +0 - +63

Normal Part (FM-X) Edit

Common

Part Settings

General

Algorithm

Zone Settings

Zone Transmit

Pitch / Filter

Pitch

PEG/Scale

Filter Type

Filter EG

Filter Scale

Effect

Routing

Ins A

Ins B

EQ

Ins Assign

Arpeggio

Common

Individual

Advanced

Motion Seq

Common

Lane

Mod / Control

Part LFO

2nd LFO

Control Assign

Receive SW

Operator

Form / Freq

Level

Copy or Exchange Operators

Normal Part (AWM2)

Drum Part

Normal Part (FM-X)

Common/Audio

KeyOnDly Sync (Key On Delay Tempo Sync Switch)

Determines whether or not “Key On Delay Time Length” is synchronized to the tempo.

Settings: Off, On

Delay Length (Key On Delay Time Length)

Determines the time (or elapsed delay) between the moment you press a note on the keyboard and the point at which the sound is actually played. You can set different delay times for each Operator. This is not available when “KeyOnDly Sync” is set to on.

Settings: 0–127

Delay Length (Key On Delay Note Length)

Determines the timing of “Key On Delay” when “KeyOnDly Sync” is set to on.

Settings: 1/16, 1/8 Tri. (eighth-note triplets), 1/16 Dot. (dotted sixteenth notes), 1/8, 1/4 Tri. (quarter-note triplets), 1/8 Dot. (dotted eighth notes), 1/4, 1/2 Tri. (half-note triplets), 1/4 Dot. (dotted quarter notes), 1/2, Whole Tri. (whole-note triplets), 1/2 Dot. (dotted half notes), 1/4 x 4 (quarter-note quadruplets; four quarter notes to the beat), 1/4 x 5 (quarter-note quintuplets; five quarter notes to the beat), 1/4 x 6 (quarter-note sextuplets; six quarter notes to the beat), 1/4 x 7 (quarter-note septuplets; seven quarter notes to the beat), 1/4 x 8 (quarter-note octuplets; eight quarter notes to the beat)

Algorithm

From the Algorithm display you can specify the Algorithm, which determines the arrangement of the Operators and how the FM sound is generated.

Operation

[PERFORMANCE (HOME)] → [EDIT] → Part selection → Operator [Common] → [Part Settings] → [Algorithm]

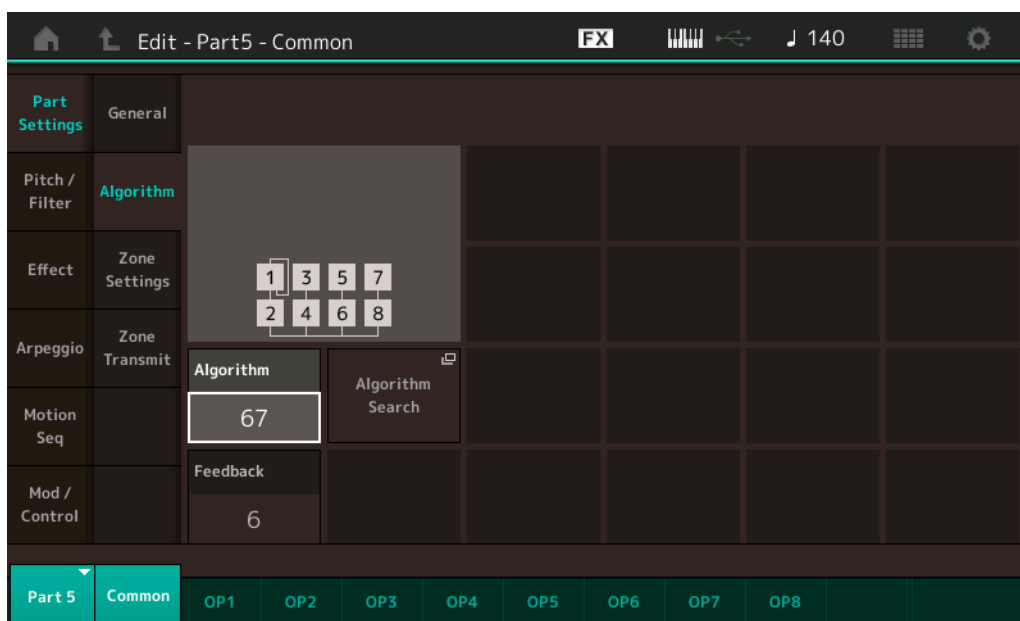

Algorithm (Algorithm Number)

Changes Algorithms.

Settings: See the Data List PDF document.

Feedback (Feedback Level)

Waveforms can be changed by feeding some of the signal generated by an operator back through that operator. This allows you to set the feedback level.

Settings: 0–7

Normal Part (FM-X) Edit

Common

Part Settings

- ▶ General
- ▶ Algorithm
- Zone Settings
- Zone Transmit

Pitch / Filter

- Pitch
- PEG/Scale
- Filter Type
- Filter EG
- Filter Scale

Effect

- Routing
- Ins A
- Ins B
- EQ
- Ins Assign

Arpeggio

- Common
- Individual
- Advanced

Motion Seq

- Common
- Lane

Mod / Control

- Part LFO
- 2nd LFO
- Control Assign
- Receive SW

Operator

- Form / Freq
- Level

Copy or Exchange Operators

Algorithm Search

Calls up the Algorithm Search display. From this display you can search for desired Algorithms by filtering the number of Carriers, or the maximum length of the serial connection of Operators.

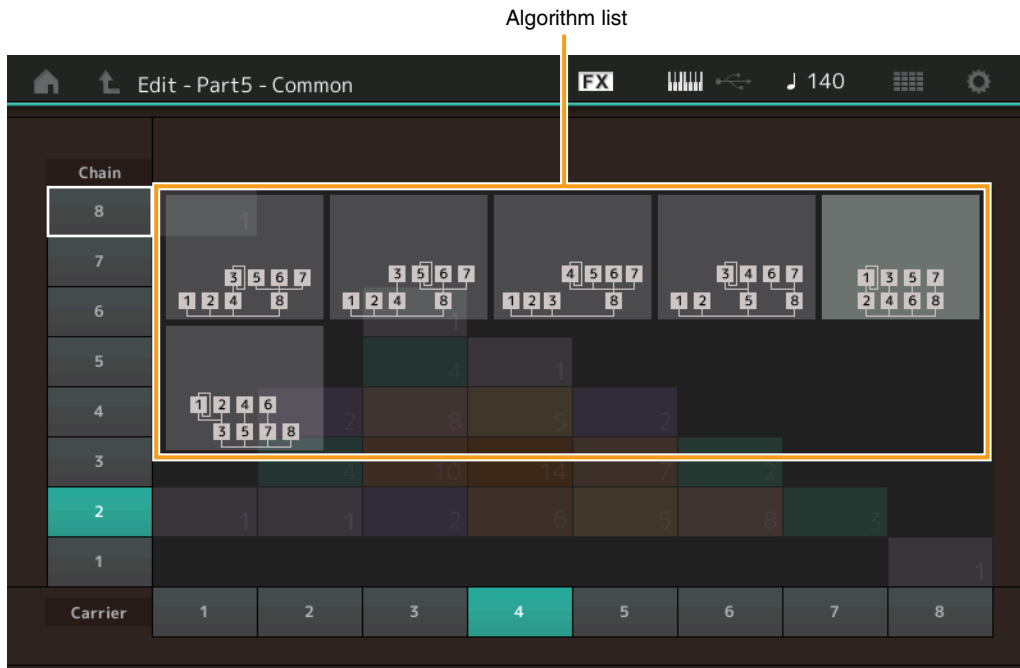

Chain

Filters the Algorithms by the maximum length of serial connection of Operators.

Settings: 1-8

Carrier

Filters the Algorithms by the number of Carriers.

Settings: 1-8

Zone Settings

Same as the Element Common Edit parameters for Normal Parts (AWM2) ([page 71](#)).

Zone Transmit

Same as the Element Common Edit parameters for Normal Parts (AWM2) ([page 73](#)).

Normal Part (FM-X) Edit

Common

Part Settings

General

▶ Algorithm

▶ Zone Settings

▶ Zone Transmit

Pitch / Filter

Pitch

PEG/Scale

Filter Type

Filter EG

Filter Scale

Effect

Routing

Ins A

Ins B

EQ

Ins Assign

Arpeggio

Common

Individual

Advanced

Motion Seq

Common

Lane

Mod / Control

Part LFO

2nd LFO

Control Assign

Receive SW

Operator

Form / Freq

Level

Copy or Exchange
Operators

Pitch/Filter

Pitch

Same as the Element Common Edit parameters for Normal Parts (AWM2) (page 68), except that the Legato Slope parameter is not available.

PEG/Scale (Pitch EG/Scale)

From the Pitch EG/Scale display you can make all time and level settings for the Pitch EG, which determine how the pitch of the sound changes over time, and the Scale for Parts.

Operation

[PERFORMANCE (HOME)] → [EDIT] → Part selection → Operator [Common] → [Pitch/Filter] → [PEG/Scale]

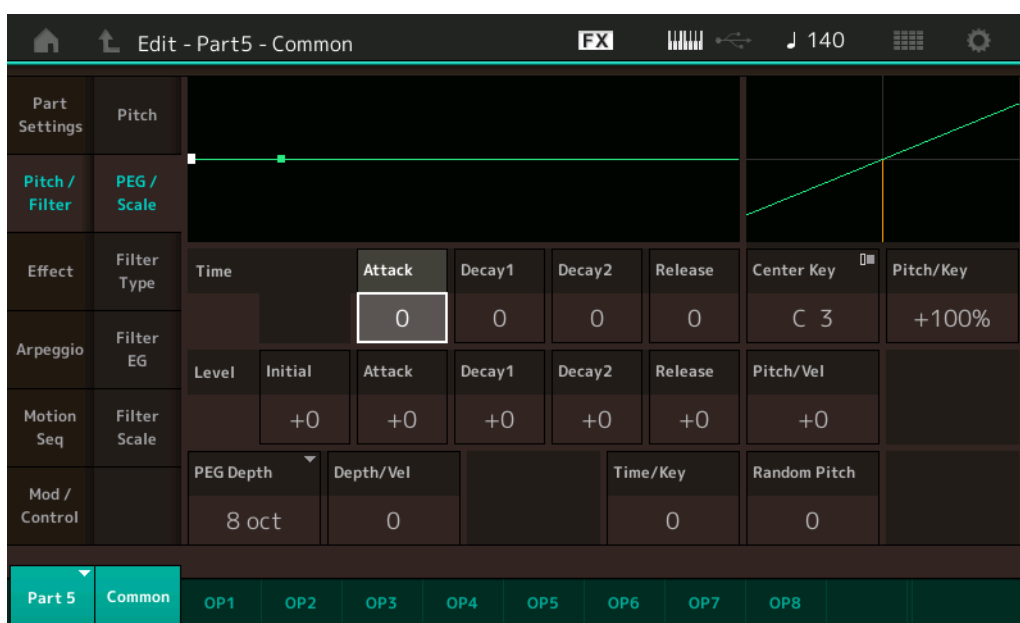

The full names of the available parameters are shown in the chart below, as they appear in the display.

	Initial	Attack	Decay1	Decay2	Release
Time	–	Attack Time	Decay1 Time	Decay2 Time	Release Time
Level	Hold Level	Attack Level	Decay1 Level	Decay2 Level	Release Level

Settings: Time: 0–99

Level: -50 – +50

PEG Depth

Determines the pitch range for Pitch EG.

Settings: 8 oct, 2 oct, 1 oct, 0.5 oct

Depth/Vel (PEG Depth Velocity Sensitivity)

Determines how the pitch range will be generated according to the Velocity (strength) with which you play notes on the keyboard.

Settings: 0–7

Time/Key (PEG Time Key Follow Sensitivity)

Determines the degree to which the notes (specifically, their position or octave range) affect the Pitch EG Times. The Center Key (C3) is used as the basic pitch for this parameter.

Settings: 0–7

Positive values: High notes result in a high PEG transition speed while low notes result in a slow speed.

0: The PEG transition speed does not change, regardless of the played note.

Normal Part (FM-X) Edit

Common

Part Settings

General

Algorithm

Zone Settings

Zone Transmit

▶ Pitch / Filter

▶ Pitch

▶ PEG/Scale

Filter Type

Filter EG

Filter Scale

Effect

Routing

Ins A

Ins B

EQ

Ins Assign

Arpeggio

Common

Individual

Advanced

Motion Seq

Common

Lane

Mod / Control

Part LFO

2nd LFO

Control Assign

Receive SW

Operator

Form / Freq

Level

Copy or Exchange Operators

Pitch/Key (Pitch Key Follow Sensitivity)

Determines the sensitivity of the Key Follow effect (the pitch interval of adjacent notes), assuming the pitch of the Center Key (below) as standard.

Settings: -200% – +0% – +200%

+100% (the normal setting): Adjacent notes are pitched one semitone apart.

0%: All notes have the same pitch as the Center Key.

Negative values: The settings are reversed.

Center Key (Pitch Key Follow Sensitivity Center Key)

Determines the central note or pitch for the Key Follow effect on pitch.

Settings: C -2 – G8

Pitch/Vel (Pitch Velocity Sensitivity)

Determines how the pitch responds to velocity.

Settings: -64 – 63

Positive values: The harder you play the keyboard, the more the pitch rises.

Negative values: The harder you play the keyboard, the more the pitch falls.

0: No change in pitch.

Random Pitch (Random Pitch Depth)

Allows you to randomly vary the pitch for each note played.

Settings: 0–127

NOTE For details on PEG, see the Synthesizer Parameter Manual PDF document.

Filter Type

Same as the Element Edit parameters for Normal Parts (AWM2) ([page 113](#)).

Filter EG

Same as the Element Edit parameters for Normal Parts (AWM2) ([page 118](#)).

Filter Scale

Same as the Element Edit parameters for Normal Parts (AWM2) ([page 120](#)).

Normal Part (FM-X) Edit

Common

Part Settings

General

Algorithm

Zone Settings

Zone Transmit

Pitch / Filter

Pitch

▶ PEG/Scale

▶ Filter Type

▶ Filter EG

▶ Filter Scale

Effect

Routing

Ins A

Ins B

EQ

Ins Assign

Arpeggio

Common

Individual

Advanced

Motion Seq

Common

Lane

Mod / Control

Part LFO

2nd LFO

Control Assign

Receive SW

Operator

Form / Freq

Level

Copy or Exchange Operators

Effect

Routing

From the Routing display you can determine the Effect connections for Parts.

Operation

[PERFORMANCE (HOME)] → [EDIT] → Part selection → Operator [Common] → [Effect] → [Routing]

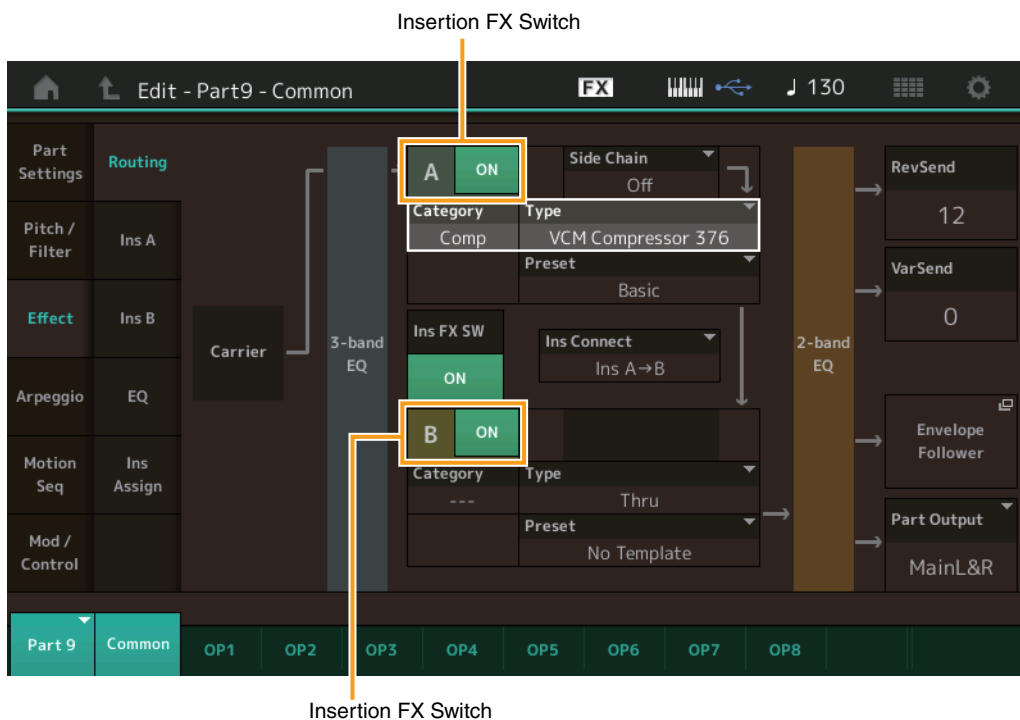

Insertion FX Switch

Determines whether the Insertion Effect A/B is active or not.

Settings: Off, On

Category (Effect Category)

Type (Effect Type)

Determines the category and type for the selected Effect.

Settings: For details on the editable Effect categories and types, see the Data List PDF document. Also, for details on the description for each Effect type, see the Synthesizer Parameter Manual PDF document.

Preset

Allows you to call up pre-programmed settings for each Effect type, designed to be used for specific applications and situations.

Settings: For a list of all Preset Effects, see the Data List PDF document.

Side Chain/Modulator (Side Chain/Modulator Part)

Determines the Part used for the Side Chain/Modulator. This is not active depending on Effect Types. For details on the Side Chain/Modulator, see the Routing display (page 76) of the Normal Part (AWM2).

Settings: Part 1–16, A/D, Master, Off

Ins Connect (Insertion Connection Type)

Determines the effect routing for Insertion Effects A and B. The setting changes are shown on the diagram in the display, giving you a clear picture of how the signal is routed. For details, see the section “Effect connection” (page 20) of the “Basic Structure.”

Settings: Parallel, Ins A→B, Ins B→A

Normal Part (FM-X) Edit

Common

Part Settings

General

Algorithm

Zone Settings

Zone Transmit

Pitch / Filter

Pitch

PEG/Scale

Filter Type

Filter EG

Filter Scale

Effect

Routing

Ins A

Ins B

EQ

Ins Assign

Arpeggio

Common

Individual

Advanced

Motion Seq

Common

Lane

Mod / Control

Part LFO

2nd LFO

Control Assign

Receive SW

Operator

Form / Freq

Level

Copy or Exchange Operators

Rev Send (Reverb Send)

Determines the Send level of the signal sent from Insertion Effect A/B to the Reverb effect.

Settings: 0–127

Var Send (Variation Send)

Determines the Send level of the signal sent from Insertion Effect A/B to the Variation effect.

Settings: 0–127

Part Output (Part Output Select)

Determines the specific audio output.

Settings: MainL&R, USB1&2...USB7&8, USB1...USB8, Off

MainL&R: Outputs in stereo (two channels) to the OUTPUT [L/MONO]/[R] jacks.

USB1&2...USB7&8: Outputs in stereo (Channels 1&2–7&8) to the [USB TO HOST] terminal.

USB1...USB8: Outputs in mono (Channels 1–8) to the [USB TO HOST] terminal.

Off: No audio signal for the Part is output.

**Ins A (Insertion Effect A)
Ins B (Insertion Effect B)**

Same as the Element Common Edit parameters for Normal Parts (AWM2) ([page 77](#)).

EQ (Part Equalizer)

Same as the Element Common Edit parameters for Normal Parts (AWM2) ([page 78](#)).

Ins Assign (Insertion Assign)

Same as the Element Common Edit parameters for Normal Parts (AWM2) ([page 81](#)).

Arpeggio**Common**

Same as the Element Common Edit parameters for Normal Parts (AWM2) ([page 82](#)).

Individual

Same as the Element Common Edit parameters for Normal Parts (AWM2) ([page 85](#)).

Advanced

Same as the Element Common Edit parameters for Normal Parts (AWM2) ([page 87](#)).

Motion Seq (Motion Sequencer)**Common**

Same as the Element Common Edit parameters for Normal Parts (AWM2) ([page 88](#)).

Lane

Same as the Element Common Edit parameters for Normal Parts (AWM2) ([page 91](#)).

Normal Part (FM-X) Edit

Common**Part Settings**

General

Algorithm

Zone Settings

Zone Transmit

Pitch / Filter

Pitch

PEG/Scale

Filter Type

Filter EG

Filter Scale

Effect

▶ Routing

▶ Ins A

▶ Ins B

▶ EQ

▶ Ins Assign

▶ Arpeggio

▶ Common

▶ Individual

▶ Advanced

▶ Motion Seq

▶ Common

▶ Lane

Mod / Control

Part LFO

2nd LFO

Control Assign

Receive SW

Operator

Form / Freq

Level

**Copy or Exchange
Operators**

Mod/Control (Modulation/Control)

Normal Part (FM-X) Edit

Part LFO

Same as the Element Common Edit parameters for Normal Parts (AWM2) (page 96), except that the setting values of the Destination parameter differ and that “Element Phase Offset (LFO Element Phase Offset)” is not available. For details on the setting values, see the Data List PDF document.

2nd LFO

Operation

[PERFORMANCE (HOME)] → [EDIT] → Part selection → Operator [Common] → [Mod/Control] → [2nd LFO]

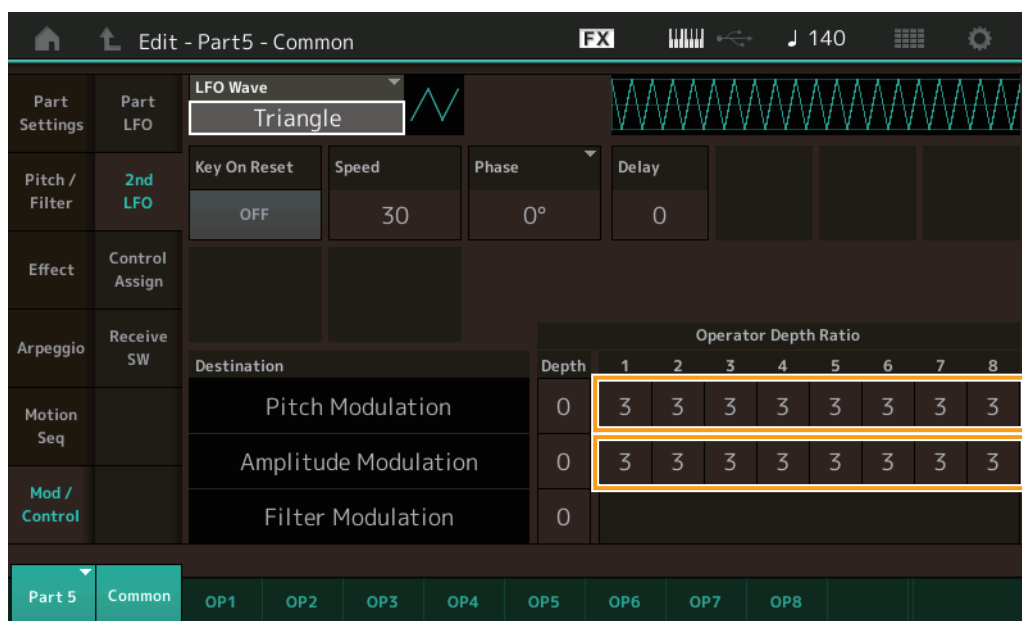

Pitch Modulation Operator Depth Ratio
(2nd LFO Pitch Modulation Operator Depth Ratio)

Amplitude Modulation Operator Depth Ratio
(2nd LFO Amplitude Modulation Operator Depth Ratio)

LFO Wave (2nd LFO Waveform)

Selects the 2nd LFO waveform.

Settings: Triangle, Saw Down, Saw Up, Square, Sine, S/H

NOTE When “Sine” is selected, two waves will be shown in the diagram on the display because of the phase shift of the Amplitude Modulation wave.

Key On Reset (2nd LFO Key On Reset)

Determines whether or not the 2nd LFO is reset each time a note is pressed.

Settings: Off, On

Speed (2nd LFO Speed)

Adjusts the speed (frequency) of the 2nd LFO variation.

Settings: 0–99

Phase (2nd LFO Phase)

Determines the starting phase point for the 2nd LFO Wave when it is reset.

Settings: 0°, 90°, 180°, 270°

Delay (2nd LFO Delay Time)

Determines the delay time between the moment you press a key on the keyboard and the moment the 2nd LFO comes into effect.

Settings: 0–99

Common

Part Settings

General

Algorithm

Zone Settings

Zone Transmit

Pitch / Filter

Pitch

PEG/Scale

Filter Type

Filter EG

Filter Scale

Effect

Routing

Ins A

Ins B

EQ

Ins Assign

Arpeggio

Common

Individual

Advanced

Motion Seq

Common

Lane

Mod / Control

Part LFO

2nd LFO

Control Assign

Receive SW

Operator

Form / Freq

Level

Copy or Exchange Operators

Pitch Modulation (2nd LFO Pitch Modulation Depth)

Determines the amount (depth) by which the 2nd LFO waveform varies (modulates) the pitch of the sound.

Settings: 0–99

Amplitude Modulation (2nd LFO Amplitude Modulation Depth)

Determines the amount (depth) by which the 2nd LFO waveform varies (modulates) the amplitude or volume of the sound.

Settings: 0–99

Filter Modulation (2nd LFO Filter Modulation Depth)

Determines the amount (depth) by which the 2nd LFO waveform varies (modulates) the Filter Cutoff frequency.

Settings: 0–99

Pitch Modulation Operator Depth Ratio (2nd LFO Pitch Modulation Operator Depth Ratio)

Adjusts the amount (depth) which is determined in the “2nd LFO Pitch Modulation Depth” for each Operator.

Settings: 0–7

Amplitude Modulation Operator Depth Ratio (2nd LFO Amplitude Modulation Operator Depth Ratio)

Adjusts the amount (depth) which is determined in the “2nd LFO Amplitude Modulation Depth” for each Operator.

Settings: 0–7

Control Assign

Operation

[PERFORMANCE (HOME)] → [EDIT] → Part selection → Operator [Common] → [Mod/Control] → [Control Assign]

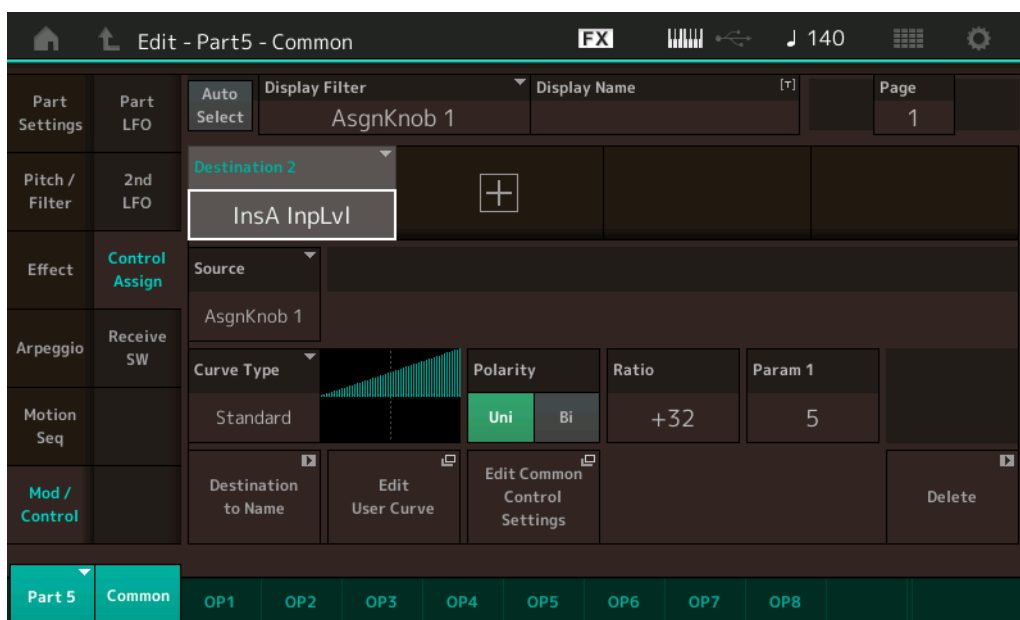

Same as the Element Common Edit parameters for Normal Parts (AWM2) (page 100), except for the different setting values in the Destination parameter. For details on the setting value, see the Data List PDF document.

Also the following parameter is shown on this display.

Operator SW (Operator Switch)

Selects whether the controller will affect each individual Operator (On) or not (Off). This is available only when an Operator-related parameter is set in “Destination.”

Settings: Off, On

Normal Part (FM-X) Edit

Common

Part Settings

General

Algorithm

Zone Settings

Zone Transmit

Pitch / Filter

Pitch

PEG/Scale

Filter Type

Filter EG

Filter Scale

Effect

Routing

Ins A

Ins B

EQ

Ins Assign

Arpeggio

Common

Individual

Advanced

Motion Seq

Common

Lane

Mod / Control

Part LFO

▶ 2nd LFO

▶ Control Assign

Receive SW

Operator

Form / Freq

Level

Copy or Exchange Operators

Normal Part (AWM2)

Drum Part

Normal Part (FM-X)

Common/Audio

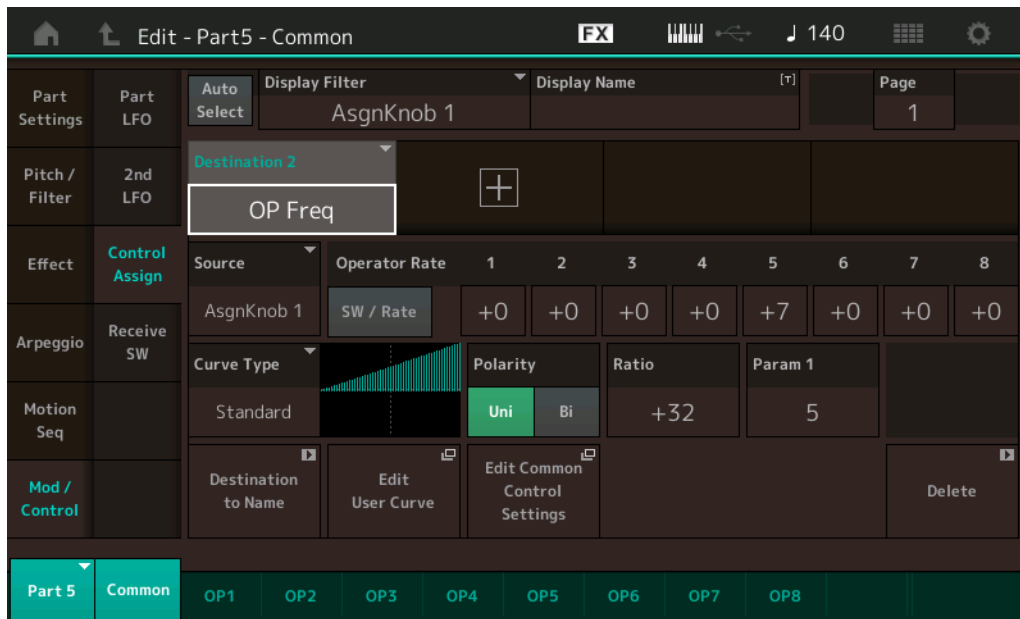

Operator Rate

Determines the sensitivity of the Controller in changing the parameter set in “Destination” for each Operator.

This is available only when “Destination” is set to “OP Freq” or “OP AEG Offset.”

Settings: Off, On

SW/Rate (Operator Switch/Operator Rate Switch)

Switches displays between “Operator Switch” and “Operator Rate.”

This is available only when “Destination” is set to “OP Freq” or “OP AEG Offset.”

Settings: Off, On

Receive SW (Receive Switch)

Same as the Element Common Edit parameters for Normal Parts (AWM2) ([page 105](#)).

Normal Part (FM-X) Edit

Common

Part Settings

- General
- Algorithm
- Zone Settings
- Zone Transmit

Pitch / Filter

- Pitch
- PEG/Scale
- Filter Type
- Filter EG
- Filter Scale

Effect

- Routing
- Ins A
- Ins B
- EQ
- Ins Assign

Arpeggio

- Common
- Individual
- Advanced

Motion Seq

- Common
- Lane

Mod / Control

- Part LFO
- 2nd LFO
- ▶ Control Assign
- ▶ Receive SW

Operator

- Form / Freq
- Level

Copy or Exchange Operators

Operator Edit (Operator)

Form/Freq (Form/Frequency)

From the Form/Frequency display you can make all the waveform and frequency settings for Operators.

Operation [PERFORMANCE (HOME)] → [EDIT] → Part selection → Operator selection → [Form/Freq]

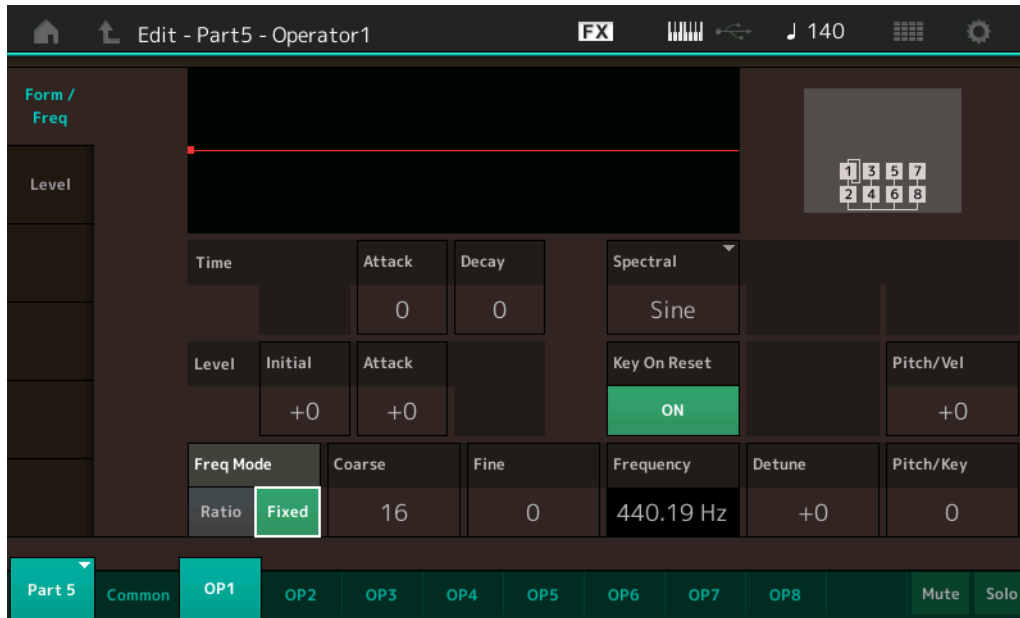

The full names of the available parameters are shown in the chart below, as they appear in the display.

	Initial	Attack	Decay
Time	–	Attack Time	Decay Time
Level	Initial Level	Attack Level	–

Settings: Time: 0–99
Level: -50 – +50

Spectral (Spectral Form)

Determines the “spectral form” of the selected Operator.

Settings: Sine, All 1, All 2, Odd 1, Odd 2, Res 1, Res 2

Skirt (Spectral Skirt)

Determines the spread of the “skirt” at the bottom of the formant harmonics curve. Higher values produce a wider skirt and smaller values produce a narrower skirt. This is not available when “Spectral” is set to “Sine.”

Settings: 0–7

Resonance (Spectral Resonance)

Determines the degree to which velocity affects the Resonance of the Spectral Form. The center frequency moves to higher frequencies, letting you create a special resonance in the sound. This is active only when “Spectral” is set to “Res 1” or “Res 2.”

Settings: 0–99

Normal Part (FM-X) Edit

Common

Part Settings

- General
- Algorithm
- Zone Settings
- Zone Transmit

Pitch / Filter

- Pitch
- PEG/Scale
- Filter Type
- Filter EG
- Filter Scale

Effect

- Routing
- Ins A
- Ins B
- EQ
- Ins Assign

Arpeggio

- Common
- Individual
- Advanced

Motion Seq

- Common
- Lane

Mod / Control

- Part LFO
- 2nd LFO
- Control Assign
- Receive SW

Operator

▶ Form / Freq

Level

Copy or Exchange Operators

Basic waveforms used as Operators contain harmonics, with the exception of "Sine." A sine wave contains its fundamental frequency with no additional harmonics. Therefore, when "Form" is set to any waveform other than "Sine," you can adjust harmonics and the peak of each formant, depending on the Waveform Type by determining the related parameters. Below are the basic waveforms and the characteristic parameters.

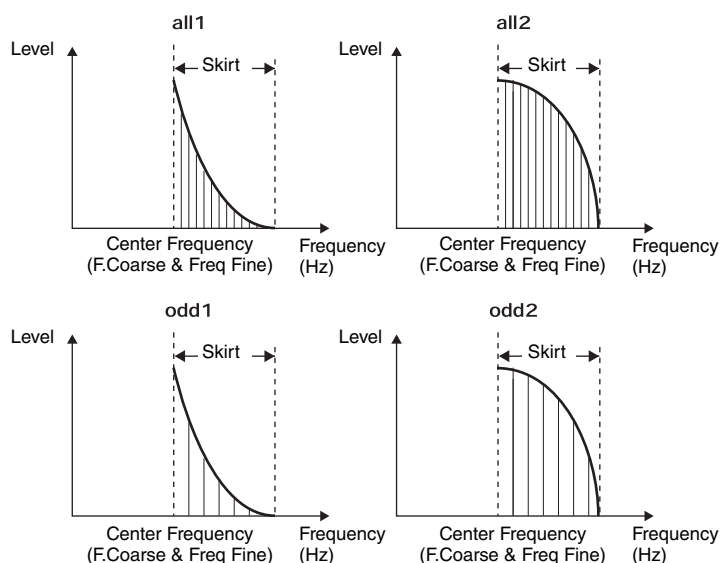

The larger the "Skirt" value, the more harmonics the wave contains.

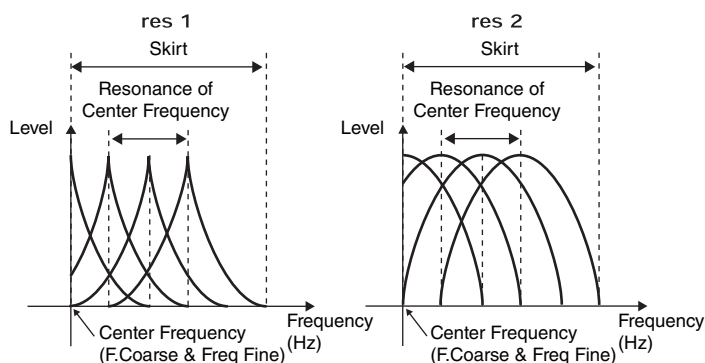

The larger "Resonance" value, the higher frequency the center frequency is moved.

- Resonance=0: The Center frequency is the basic wave
- Resonance=99: The Center frequency is the 100th harmonic

Key On Reset (Oscillator Key On Reset)

Determines whether or not the oscillation of the Operator is reset each time a note is pressed.

Settings: Off, On

Pitch/Vel (Pitch Velocity Sensitivity)

Determines how the pitch of the selected Operator responds to velocity. This is available only when "Freq Mode" is set to "Fixed."

Settings: -7 - +7

Positive values: The harder you play the keyboard, the more the pitch rises.

Negative values: The harder you play the keyboard, the more the pitch falls.

0: No change in pitch.

Freq Mode (Oscillator Frequency Mode)

Determines the settings for the Output Pitch of the Operator.

Settings: Ratio, Fixed

Ratio: Determines the Output Pitch by detecting the note you play on the keyboard.

Fixed: Specifies the Pitch by setting "Coarse" and "Fine."

Normal Part (FM-X) Edit

Common

Part Settings

General

Algorithm

Zone Settings

Zone Transmit

Pitch / Filter

Pitch

PEG/Scale

Filter Type

Filter EG

Filter Scale

Effect

Routing

Ins A

Ins B

EQ

Ins Assign

Arpeggio

Common

Individual

Advanced

Motion Seq

Common

Lane

Mod / Control

Part LFO

2nd LFO

Control Assign

Receive SW

Operator

▶ Form / Freq

Level

Copy or Exchange Operators

Coarse (Coarse Tune)

Determines the pitch of each Operator.

Settings: When "Freq Mode" is set to "Ratio": 0–31
When "Freq Mode" is set to "Fixed": 0–21

Fine (Fine Tune)

Determines the fine tuning for the pitch of each Operator.

Settings: When "Freq Mode" is set to "Ratio": 0–99
When "Freq Mode" is set to "Fixed": 0–127

Detune

Sets the Output Pitch of the Operator slightly higher or lower.

Even if the same parameter value is set for both "Coarse Tune" and "Fine Tune," the Detune lets you slightly raise or lower the pitch of each Operator, allowing you to add an extra dimension to the sound and enhance the spatial characteristics.

Settings: -15 – +15

Pitch/Key (Pitch Key Follow Sensitivity)

Determines the sensitivity of the Key Follow effect (the degree depending on their position or octave range). This is available only when "Freq Mode" is set to "Fixed."

Settings: 0–99

0: All notes are the same pitch specified by Coarse and Fine.

99: Adjacent notes are pitched one semitone apart.

Level

From the Level display you can make all the volume settings for the Operator.

Operation

[PERFORMANCE (HOME)] → [EDIT] → Part selection → Operator selection → [Level]

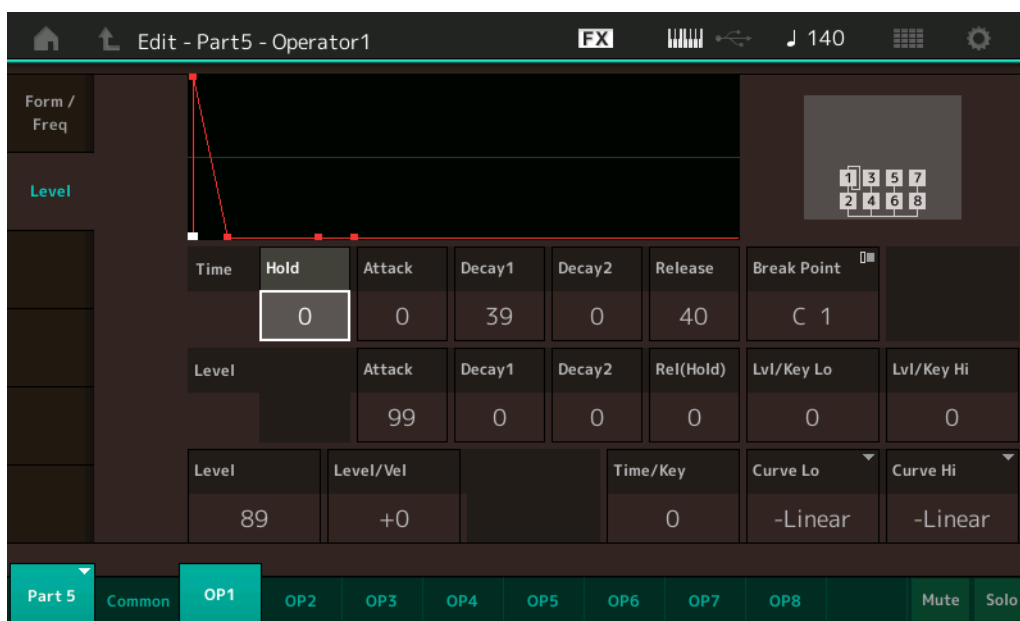

The full names of the available parameters are shown in the chart below, as they appear in the display.

	Hold	Attack	Decay1	Decay2	Release
Time	Hold Time	Attack Time	Decay1 Time	Decay2 Time	Release Time
Level	–	Attack Level	Decay1 Level	Decay2 Level	Release (Hold) Level

Settings: Time: 0–99

Level: 0–99

Level (Operator Level)

Determines the output level of the Operator.

Settings: 0–99

Normal Part (FM-X) Edit

Common

Part Settings

General

Algorithm

Zone Settings

Zone Transmit

Pitch / Filter

Pitch

PEG/Scale

Filter Type

Filter EG

Filter Scale

Effect

Routing

Ins A

Ins B

EQ

Ins Assign

Arpeggio

Common

Individual

Advanced

Motion Seq

Common

Lane

Mod / Control

Part LFO

2nd LFO

Control Assign

Receive SW

Operator

▶ Form / Freq

▶ Level

Copy or Exchange Operators

Level/Vel (Level Velocity Sensitivity)

Determines how the output level of the Operator responds to Velocity.

Settings: -7 – +7

Positive values: The more strongly you play the keyboard, the more the output rises.

Negative values: The more softly you play the keyboard, the more the output rises.

0: The output level does not change.

Time/Key (AEG Time Key Follow Sensitivity)

Determines the degree to which the notes (specifically, their position or octave range) affect the Amplitude EG Times.

Settings: 0–7

Positive values: High notes result in a fast Amplitude EG transition speed while low notes result in a slow speed.

0: The Amplitude EG transition speed does not change, regardless of the played note.

Break Point

Determines the Amplitude Scale Break Points by specifying their respective note numbers.

Settings: A-1 – C8

Curve Lo (Low Curve)

Curve Hi (High Curve)

Determines the curve for Amplitude scaling.

Settings: -Linear, -Exp, +Exp, +Linear

Lvl/Key Lo (Low Depth)

Lvl/Key Hi (High Depth)

Determines the curve degree of the curve (above).

Settings: 0–99

The keyboard is divided in two at the break point.

The high-pitch side at the right is set by using the R Depth and the R Curve; the low-pitch side at the left is set by using the L Depth and the L Curve as described below.

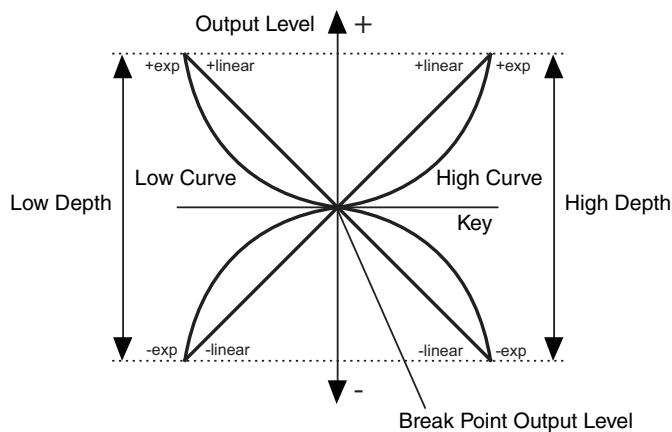

The Output level of the Key set as the Break Point depends on the Operator Level setting. For the Keys in the left side of the Break Point, the Output level is adjusted based on the curve which is determined by the Low Curve and Low Depth. For the Keys in the right side of the Break Point, the Output level is adjusted based on the curve which is determined by the High Curve and High Depth. The Output level changes in an exponential fashion from the Break Point on the Exp type curve and the Output level changes in a linear fashion from the Break Point in the Linear type curve. In either case, the farther away from the Break Point the key is, the greater the Output level changes for the key.

■ Copying or Exchanging Operators

Same as “Copying or Exchanging Elements” for Normal Parts (AWM2) ([page 132](#)).

Normal Part (FM-X) Edit

Common

Part Settings

General

Algorithm

Zone Settings

Zone Transmit

Pitch / Filter

Pitch

PEG/Scale

Filter Type

Filter EG

Filter Scale

Effect

Routing

Ins A

Ins B

EQ

Ins Assign

Arpeggio

Common

Individual

Advanced

Motion Seq

Common

Lane

Mod / Control

Part LFO

2nd LFO

Control Assign

Receive SW

Operator

Form / Freq

▶ Level

Copy or Exchange Operators

Common/Audio Edit (Common/Audio)

A Performance consists up to 16 Parts. You can set the parameters related to the entire Performance and the Audio Parts in the Common/Audio Edit display.

General

From the General display you can set various parameters for the Performance.

Operation [PERFORMANCE (HOME)] → [EDIT] → [General]

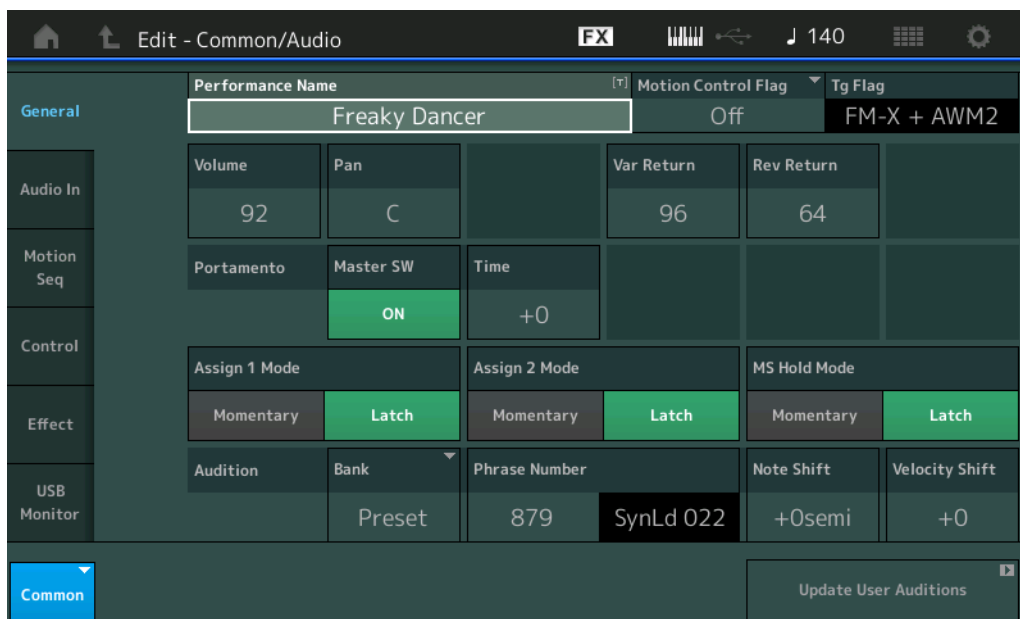

Performance Name

Determines the selected Performance name. Performance names can contain up to 20 characters. Touching the parameter calls up the input character display.

Motion Control Flag

Determines whether or not to add the "Motion Control" attribute to the selected Performance. When this is set to on, the "MC" icon is displayed in the Performance Play display (page 27). The Performance can be filtered as "MC" in the Performance Category Search display (page 176).

Settings: Off, On

Tg Flag (Tone Generator Flag)

Shows the attribute by the Tone Generator of the selected Performance. The name icon of the selected Tone Generator is displayed in the Performance Play display (page 27). The Performance can be filtered as "AWM2/FM/AWM2+FM-X" in the Performance Category Search display (page 176).

Settings: AWM2, FM-X, AWM2+FM-X

Volume (Performance Volume)

Determines the output volume of the selected Performance.

Settings: 0-127

Pan

Determines the stereo pan position of the selected Performance.

Settings: L63-C-R63

Var Return (Variation Return)

Determines the return level of the Variation effect.

Settings: 0-127

Common/Audio Edit

Common/Audio

General

Audio In

Mixing

Routing

Ins A

Ins B

EQ

Motion Seq

Common

Lane

Control

Control Assign

Control Number

Effect

Routing

Variation

Reverb

Master FX

Master EQ

USB Monitor

Rev Return (Reverb Return)

Determines the return level of the Reverb effect.

Settings: 0–127

Audition Phrase Bank

Selects an Audition Phrase Bank.

Audition Phrase Number

Determines the Audition Phrase Number. You can hear a sample of the selected Performance sounds that is called “Audition phrase.” The best matching Audition Phrase is assigned to each Preset Performance in advance.

Settings: 1–1093

Note Shift (Audition Phrase Note Shift)

Determines the pitch (key transpose) setting for the Audition Phrase in semitones.

Settings: -24semi – +24semi

Velocity Shift (Audition Phrase Velocity Shift)

Determines the velocity of the Audition Phrase.

Settings: -63 – +63

Portamento Master SW (Portamento Master Switch)

Determines whether Portamento is applied to the Part or not when the “Portamento Part SW” is set to on for the Part.

Settings: Off, On

Portamento Time

Determines the pitch transition time or rate when Portamento is applied.

Settings: -64 – +63

Assign 1 Mode/Assign 2 Mode (Assignable Switch 1 Mode/Assignable Switch 2 Mode)

Determines whether the [ASSIGN 1] and [ASSIGN 2] buttons functions as a latch type or momentary type.

Settings: Latch, Momentary

Latch: When set to “Latch,” pressing the button alternates the status between on and off.

Momentary: When set to “Momentary,” pressing/holding the button turns on and releasing the button turns off.

MS Hold Mode (Motion Sequencer Hold Mode)

Determines how the [MOTION SEQ HOLD] button responds when pressed.

Settings: Latch, Momentary

Latch: When set to “Latch,” pressing the button alternates the status between on and off.

Momentary: When set to “Momentary,” pressing/holding the button turns on and releasing the button turns off.

Update User Auditions

Converts all of the songs recorded on the MODX to User Auditions. If the User Auditions already exist, all User Auditions will be overwritten.

Common/Audio Edit

Common/Audio

▶ General

Audio In

Mixing

Routing

Ins A

Ins B

EQ

Motion Seq

Common

Lane

Control

Control Assign

Control Number

Effect

Routing

Variation

Reverb

Master FX

Master EQ

USB Monitor

Audio In

Mixing

From the Mixing display you can adjust the volume settings of the Audio Part (the input signal from the A/D INPUT [L/MONO]/[R] jacks) and the Digital Part (the input signal from the [USB TO HOST] terminal*).

* Only the sound of the Port which, among all Device Ports, is set to "Digital L/R."

Operation [PERFORMANCE (HOME)] → [EDIT] → [Audio In] → [Mixing]

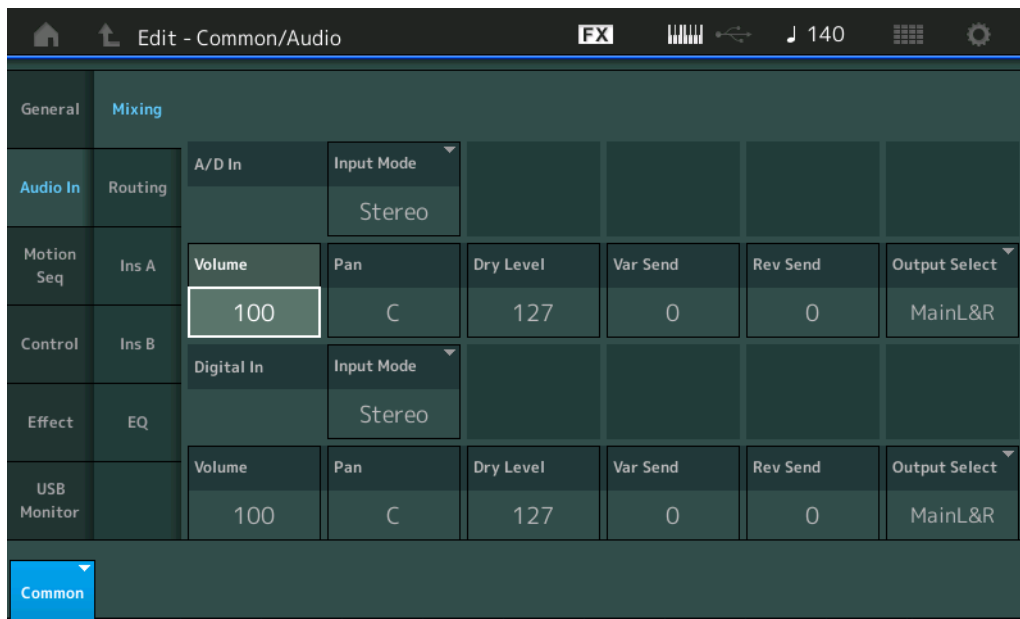

Common/Audio Edit

Common/Audio

General

▶ Audio In

▶ Mixing

Routing

Ins A

Ins B

EQ

Motion Seq

Common

Lane

Control

Control Assign

Control Number

Effect

Routing

Variation

Reverb

Master FX

Master EQ

USB Monitor

A/D In Input Mode/Digital In Input Mode (A/D Part Input Mode/Digital Part Input Mode)

Determines the signal configuration for the A/D Part/Digital Part, or how the signal or signals are routed (stereo or mono).

Settings: L Mono, R Mono, L+R Mono, Stereo

L Mono: Only the L channel is used.

R Mono: Only the R channel is used.

L+R Mono: The L and R channels are mixed and processed in mono.

Stereo: Both the L and R channels are used.

NOTE The sound input only from the [L/MONO] channel is processed in mono.

Volume (A/D Part Volume/Digital Part Volume)

Determines the output level of the A/D Part/Digital Part.

Settings: 0–127

Pan (A/D Part Pan/Digital Part Pan)

Determines the stereo pan position of the A/D Part/Digital Part.

Settings: L63–C–R63

Dry Level (A/D Part Dry Level/Digital Part Dry Level)

Determines the level of the A/D Part/Digital Part which has not been processed with the System Effect. This is available only when "Part Output" is set to "MainL&R."

Settings: 0–127

Var Send (A/D Part Variation Send / Digital Part Variation Send)

Determines the Send level of the Audio Part/Digital Part signal sent to the Variation effect. This is available only when "Part Output" is set to "MainL&R," and for the A/D Part, "Global A/D" is set to "OFF."

Settings: 0–127

Rev Send (A/D Part Reverb Send/Digital Part Reverb Send)

Determines the Send level of the Audio Part/Digital Part signal sent to the Reverb effect. This is available only when "Part Output" is set to "MainL&R," and for the A/D Part, "Global A/D" is set to "OFF."

Settings: 0–127

Output Select (A/D Part Part Output Select/Digital Part Part Output Select)

Determines the specific output(s) for the individual A/D Part/Digital Part signal.

Settings: MainL&R, USB1&2...USB7&8, USB1...USB8, Off

MainL&R: Outputs in stereo (two channels) to the OUTPUT [L/MONO]/[R] jacks.

USB1&2...USB7&8: Outputs in stereo (Channels 1&2–7&8) to the [USB TO HOST] terminal.

USB1...USB8: Outputs in mono (Channels 1–8) to the [USB TO HOST] terminal.

Off: No audio signal for the Part is output.

Routing

From the Routing display you can determine the Effect connections for the A/D Part.

Operation [PERFORMANCE (HOME)] → [EDIT] → [Audio In] → [Routing]

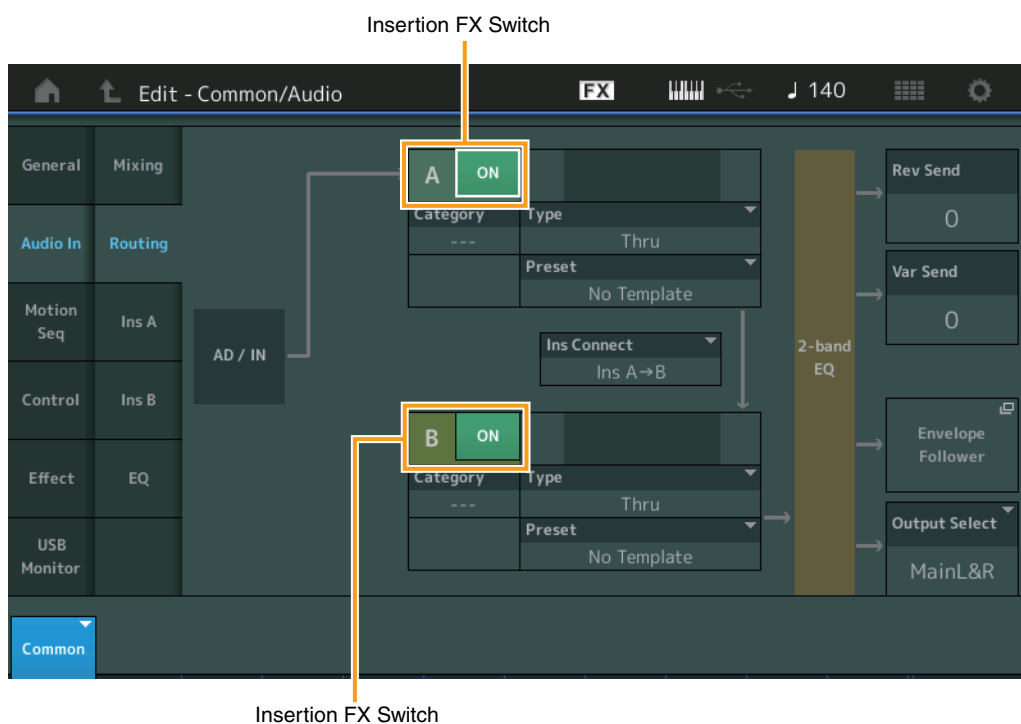

Insertion FX Switch (Insertion Effect Switch)

Determines whether the Insertion Effect A/B is active or not.

Settings: Off, On

Category (Effect Category)

Type (Effect Type)

Determines the category and type for the selected Effect.

Settings: For details on the editable Effect categories and types, see the Data List PDF document. Also, for details on the description for each Effect type, see the Synthesizer Parameter Manual PDF document.

Preset

Allows you to call up pre-programmed settings for each Effect type, designed to be used for specific applications and situations. You can change how the sound is affected by the selected pre-programmed settings.

Settings: For a list of all Preset Effects, see the Data List PDF document.

Common/Audio Edit

Common/Audio

General

Audio In

▶ Mixing

▶ Routing

Ins A

Ins B

EQ

Motion Seq

Common

Lane

Control

Control Assign

Control Number

Effect

Routing

Variation

Reverb

Master FX

Master EQ

USB Monitor

Side Chain/Modulator (Side Chain/Modulator Part)

Determines the Part used for the Side Chain/Modulator.

This is not available depending on the Effect Type.

For details on the Side Chain/Modulator, see the Routing display of the Normal Part (AWM2) ([page 76](#)).

Settings: Part 1–16, A/D, Master, Off

Ins Connect (Insertion Connection Type)

Determines the effect routing for Insertion Effects A and B. The setting changes are shown on the diagram in the display, giving you a clear picture of how the signal is routed. For details, see the section “Effect connection” ([page 20](#)) of the “Basic Structure.”

Settings: Ins A→B, Ins B→A

Rev Send (Reverb Send)

Determines the Send level of the signal sent from Insertion Effect A/B (or the bypassed signal) to the Reverb effect. This is available only when “Part Output” is set to “MainL&R” and “Global A/D” is set to “OFF.”

Settings: 0–127

Var Send (Variation Send)

Determines the Send level of the signal sent from Insertion Effect A/B (or the bypassed signal) to the Variation effect. This is available only when “Part Output” is set to “MainL&R” and “Global A/D” is set to “OFF.”

Settings: 0–127

Envelope Follower

Calls up the Envelope Follower setting display. For details, see the Routing display ([page 76](#)) of Normal Part (AWM2) Edit. This is available only when “Part Output” is set to “MainL&R.”

Output Select (Part Output Select)

Determines specific audio output.

Settings: MainL&R, USB1&2...USB7&8, AsgnL, USB1...USB8, Off

MainL&R: Outputs in stereo (two channels) to the OUTPUT [L/MONO]/[R] jacks.

USB1&2...USB7&8: Outputs in stereo (Channels 1&2–7&8) to the [USB TO HOST] terminal.

USB1...USB8: Outputs in mono (Channels 1–8) to the [USB TO HOST] terminal.

Off: No audio signal for the Part is output.

Ins A (Insertion Effect A)

Ins B (Insertion Effect B)

Same as the Element Common Edit parameters for Normal Parts (AWM2) ([page 77](#)).

EQ (Equalizer)

Same as the Element Common Edit parameters for Normal Parts (AWM2) ([page 78](#)) except that “3-band EQ” is inactive.

Common/Audio Edit

Common/Audio

General

Audio In

Mixing

▶ Routing

▶ Ins A

▶ Ins B

▶ EQ

Motion Seq

Common

Lane

Control

Control Assign

Control Number

Effect

Routing

Variation

Reverb

Master FX

Master EQ

USB Monitor

Motion Seq (Motion Sequencer)

Common

From the Common display you can set the parameters related to Motion Sequencer commonly used for all Parts in Common/Audio Part.

Operation [PERFORMANCE (HOME)] → [EDIT] → [Motion Seq] → [Common]



Common/Audio Edit

Common/Audio

General

Audio In

Mixing

Routing

Ins A

Ins B

EQ

Motion Seq

Common

Lane

Control

Control Assign

Control Number

Effect

Routing

Variation

Reverb

Master FX

Master EQ

USB Monitor

Common Clock Swing (Common Swing)

Determines the Swing of the Arpeggio/Motion Sequencer for the entire Performance. This is the offset value for the Swing of the Arpeggio/Motion Sequencer for each Part.

Settings: -120 – +120

Common Clock Unit (Common Unit Multiply)

Adjusts the Arpeggio/Motion Sequencer playback time for the entire Performance.

This parameter is applied to the Part when the Unit Multiply parameter for the Part is set to “Common.” By using this parameter, you can create a different Arpeggio/Motion Sequencer type from the original one.

Settings: 50%–400%

200%: The playback time will be doubled and the tempo is halved.

100%: The normal playback time.

50%: The playback time will be halved and the tempo doubled.

Common Arp Gate Time (Common Arpeggio Gate Time)

Determines the Gate Time Rate (length) of the Arpeggio for the entire Performance. This is the offset value for the Gate Time Rate of the Arpeggio for each Part.

Settings: -100 – +100

Common Arp Velocity (Common Arpeggio Velocity Rate)

Determines the Velocity Rate of the Arpeggio for the entire Performance. This is the offset value for the Velocity Rate of the Arpeggio for each Part.

Settings: -100 – +100

Common Motion Seq Amplitude (Common Motion Sequencer Amplitude)

Determines the Amplitude of the Motion Sequencer for the entire Performance. “Amplitude” determines how the entire Motion Sequence changes.

This is the offset value for the Part Motion Seq Amplitude, which is also the offset value for the Lane Amplitude. This results in that both of the Common and Part MS Amplitudes offset the Amplitude setting in the Lane (only when “MS FX” is set to on for the Lane).

Settings: -64 – +63

Common Motion Seq Shape (Common Motion Sequencer Pulse Shape)

Determines the Pulse Shape of the Motion Sequencer for the entire Performance. This changes the step curve shape of the sequence.

This is the offset value for the Part Motion Seq Pulse Shape, which is also the offset value for the Lane Pulse Shape. This results in that both of the Common and Part MS Pulse Shapes offset the Pulse Shape setting for the parameter in the Lane (only when "MS FX" is set to on for the Lane and "Control" is set to on for the parameter).

Settings: -100 – +100

Common Motion Seq Smooth (Common Motion Sequencer Smoothness)

Determines the Smoothness of the Motion Sequencer for the entire Performance. "Smoothness" is the degree to which the time of the Motion Sequence is smoothly changed.

This is the offset value for the Part Motion Seq Smoothness, which is also the offset value for the Lane Smoothness. This results in that both of the Common and Part MS Smoothnesses offset the Smoothness setting for the parameter in the Lane (only when "MS FX" is set to on for the Lane).

Settings: -64 – +63

Common Motion Seq Random (Common Motion Sequencer Random)

Determines the Random of the Motion Sequencer for the entire Performance. "Random" is the degree to which the Step Value of the Sequence is randomly changed.

This is the offset value for the Part Motion Seq Random when "MS FX" is set to on for the Lane.

Settings: -64 – +63

Random (A/D Part Motion Sequencer Random)

Determines the degree of random change in the Step Value of the Motion Sequence for the A/D Part is. For details about "Random," see "Quick Edit" on [page 38](#).

Settings: 0–127

Sync Part (Motion Sequencer Sync Part)

Determines the Part for synchronizing to the Motion Sequencer. The Motion Sequencer is synchronized to the Note On setting and the Arp/Motion Seq Grid setting of the specified Part.

Settings: Part 1–Part 16

Arp/MS Grid (Arpeggio/Motion Sequencer Grid)

Determines the type of note that serves as the basis for the Quantize or Swing. The parameter value is displayed in clocks. For Motion Sequencer, this parameter value is one step length. This setting is applied to the Part which is selected as the Sync Part (above).

Settings: 60 (32nd note), 80 (16th note triplet), 120 (16th note), 160 (8th note triplet), 240 (8th note), 320 (1/4 note triplet), 480 (1/4 note)

Lane

Same as the Element Common Edit parameters for Normal Parts (AWM2) ([page 91](#)).

Common/Audio Edit

Common/Audio

General

Audio In

Mixing

Routing

Ins A

Ins B

EQ

Motion Seq

▶ Common

▶ Lane

Control

Control Assign

Control Number

Effect

Routing

Variation

Reverb

Master FX

Master EQ

USB Monitor

Control

Control Assign

Operation

[PERFORMANCE (HOME)] → [EDIT] → [Control] → [Control Assign]
or
Touch [Edit Super Knob] in the Super Knob display.

Touching the “+” button adds a Part parameter to be used as a control target.

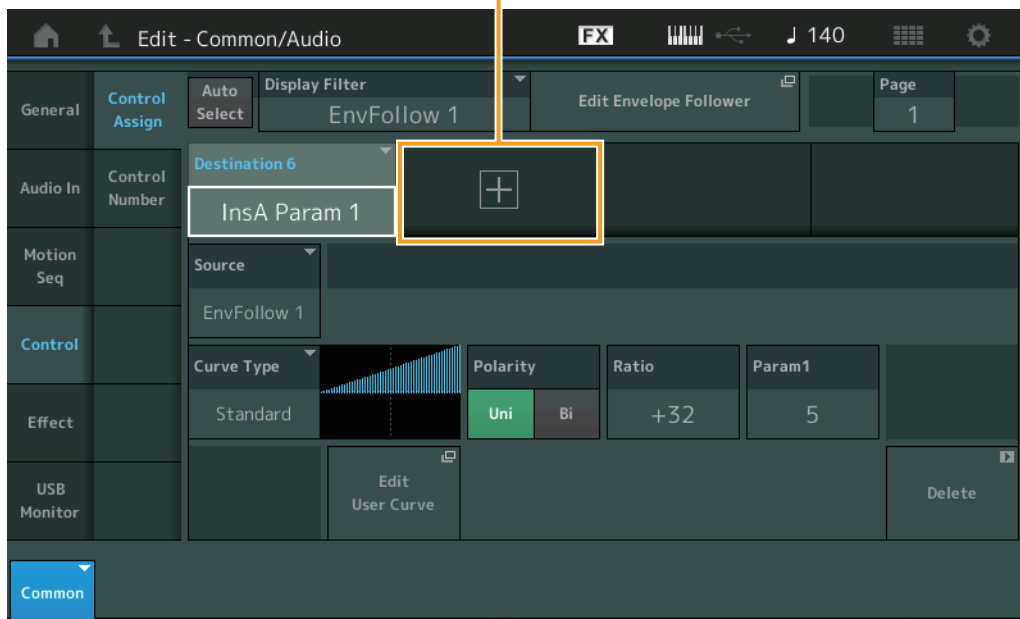

Common/Audio Edit

Common/Audio

General

Audio In

Mixing

Routing

Ins A

Ins B

EQ

Motion Seq

Common

Lane

▶ Control

▶ Control Assign

Control Number

Effect

Routing

Variation

Reverb

Master FX

Master EQ

USB Monitor

Same as the Element Common Edit parameters for Normal Parts (AWM2) ([page 100](#)), except for the following parameters.

Destination

When “Source” is set to “AsgnKnob 1–8,” “Part 1–16 Assign 1–8” are added as this parameter values. In this case, “Curve Type” and “Curve Ratio” are not selectable.

Settings: See the “Control List” in the Data List PDF document.

Source

When “Destination” is set to “Part 1–16 Assign 1–8,” only “AsgnKnob 1–8” can be set for this parameter.

Settings: AsgnKnob 1–8, MS Lane 1–4, EnvFollow 1–16, EnvFollowAD, EnvFollowMst

Display Filter

Determines the Controller to be displayed. When “Super Knob” is selected, all Assignable Knob settings in which “Super Knob Link” is set to On are displayed.

Settings: AsgnKnob 1–8, Super Knob, MS Lane 1–4, EnvFollow 1–16, EnvFollowAD, EnvFollowMst, All

The following parameters are displayed only when “Destination 1–16” is set to “Part 1–16 Assign 1–8.” Also, when Destination is not set to any Assignable Knobs for the Part, only the shortcut buttons are available.

Destination

Determines the controller settings for the Part to be displayed.

Settings: 1–16 (The number of Destinations for the Assignable Knobs for the Part which is selected in “Destination 1–16” is displayed.)

Parameter

Determines the parameters for the Part to be controlled.

Settings: Refer to the “Control List” in the Data List.

Edit Part Control Settings

Calls up the Control Assign display for the currently selected Part.

Curve Type

Determines the specific curve for changing the parameter which is set in "Destination." The horizontal axis indicates the value of the controller set in "Source" and the vertical axis indicates the parameter values.

Settings: Standard, Sigmoid, Threshold, Bell, Dogleg, FM, AM, M, Discrete Saw, Smooth Saw, Triangle, Square, Trapezoid, Tilt Sine, Bounce, Resonance, Sequence, Hold

For User Bank: User 1–32

When a Library file is read: Curves in Library 1–8

Polarity (Curve Polarity)

Determines the Curve Polarity of the Curve type set in "Curve Type."

Settings: Uni, Bi

Uni: Unipolar changes only in a positive direction or in a negative direction from a base parameter value according to the Curve shape.

Bi: Bipolar changes in both of positive and negative directions from a base parameter value.

Ratio (Curve Ratio)

Determines the Curve Ratio.

Settings: -64 – +63

Control Number

Determines the MIDI Control Change numbers common for the entire system. You can use the Knobs on the front panel and external controllers by assigning appropriate MIDI Control Change numbers. When the same control number is assigned to the Super Knob and any Assignable Knob, the Super Knob takes priority and operation of the Assignable Knob may be ignored. A warning message appears in that case.

NOTE External controllers include external sequencers and external MIDI controllers.

NOTE The Control Number set in this display is stored as Performance data. However, "FS Assign," "Super Knob CC" and "Scene CC" are stored as general system settings, and not as Performance data.

Operation [PERFORMANCE (HOME)] → [EDIT] → [Control] → [Control Number]



Ribbon Ctrl (Ribbon Controller Control Number)

Determines the Control Change Number received from an external device with a Ribbon Controller. Even when the instrument receives MIDI messages with the same Control Change Number specified here from an external device, the instrument assumes that the message is generated by operating the Ribbon Controller.

Settings: Off, 1–95

Common/Audio Edit

Common/Audio

General

Audio In

Mixing

Routing

Ins A

Ins B

EQ

Motion Seq

Common

Lane

Control

▶ Control Assign

▶ Control Number

Effect

Routing

Variation

Reverb

Master FX

Master EQ

USB Monitor

Breath Ctrl (Breath Controller Control Number)

Determines the Control Change Number received from the external equipment such as a Breath Controller. Even when the instrument receives MIDI message with the same Control Change Number specified here from the external equipment, the instrument assumes that the message is generated by operating the Breath Controller.

Settings: Off, 1–95

Foot Ctrl 1/Foot Ctrl 2**(Foot Controller 1 Control Number/Foot Controller 2 Control Number)**

Determines the Control Change Number generated by using a Foot Controller connected to the FOOT CONTROLLER [1] / [2] jack.

Even when the instrument receives MIDI messages with the same Control Change Number specified here from the external equipment, the instrument assumes that the message is generated by operating the Foot Controller.

Settings: Off, 1–95, Super Knob

Assign SW 1/Assign SW 2**(Assignable Switch 1 Control Number/Assignable Switch 2 Control Number)**

Determines the Control Change Number generated by using the [ASSIGN 1]/[ASSIGN 2] button (Assignable Switch 1/2).

Even when the instrument receives MIDI messages with the same Control Change Number specified here from the external equipment, the instrument assumes that the message is generated by operating the [ASSIGN 1]/[ASSIGN 2] button (Assignable Switch 1/2.)

Settings: Off, 1–95

MS Hold (Motion Sequencer Hold Control Number)

Determines the Control Change Number generated by using the [MOTION SEQ HOLD] (Motion Sequencer Hold) button.

Even when the instrument receives MIDI messages with the same Control Change Number specified here from the external equipment, the instrument assumes that the message is generated by operating the [MOTION SEQ HOLD] (Motion Sequencer Hold) button.

Settings: Off, 1–95

MS Trigger (Motion Sequencer Trigger Control Number)

Determines the Control Change Number generated by using the [MOTION SEQ TRIGGER] (Motion Sequencer Trigger) button.

Even when the instrument receives MIDI messages with the same Control Change Number specified here from the external equipment, the instrument assumes that the message is generated by operating the [MOTION SEQ TRIGGER] (Motion Sequencer Trigger) button.

Settings: Off, 1–95

Assign Knob 1–8 (Assignable Knob 1–8 Control Number)

Determines the Control Change Number generated by using the Assignable Knob 1–8.

Even when the instrument receives MIDI messages with the same Control Change Number specified here from the external equipment, the instrument assumes that the message is generated by operating the Assignable Knob 1–8.

Settings: Off, 1–95

MIDI Settings

Calls up the MIDI I/O display in Utility.

Common/Audio Edit

Common/Audio

General

Audio In

Mixing

Routing

Ins A

Ins B

EQ

Motion Seq

Common

Lane

Control

Control Assign

▶ Control Number

Effect

Routing

Variation

Reverb

Master FX

Master EQ

USB Monitor

Effect

Routing

From this display you can determine the System Effect and Master Effect connections that commonly affect all Parts.

Operation [PERFORMANCE (HOME)] → [EDIT] → [Effect] → [Routing]

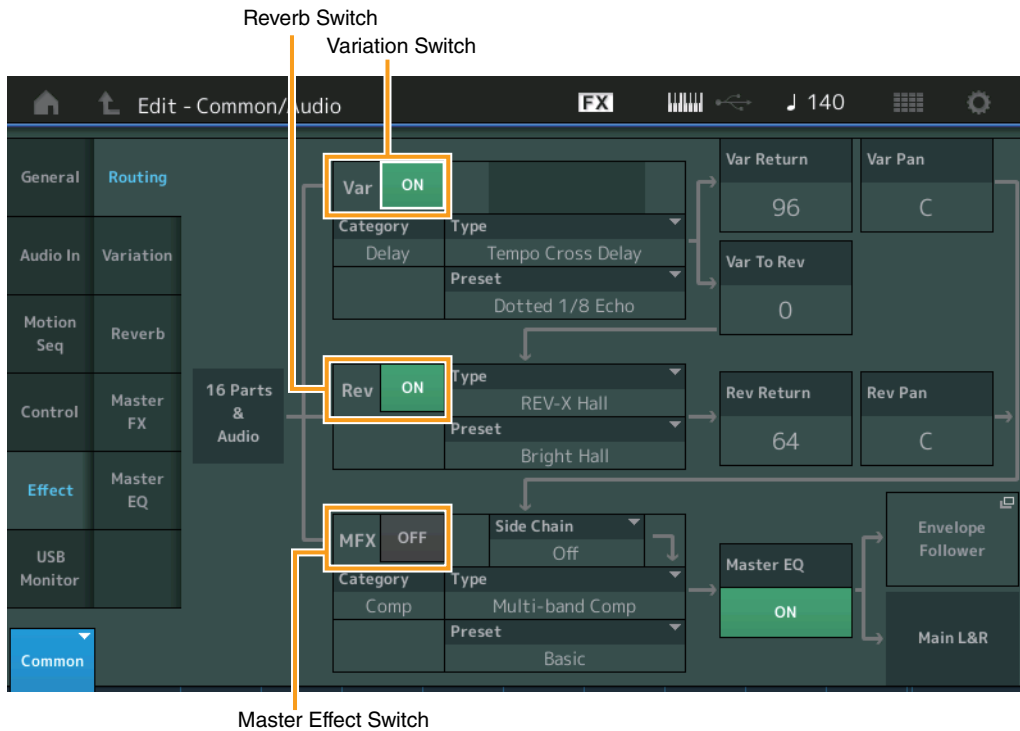

Common/Audio Edit

Common/Audio

General

Audio In

Mixing

Routing

Ins A

Ins B

EQ

Motion Seq

Common

Lane

Control

Control Assign

Control Number

▶ Effect

▶ Routing

Variation

Reverb

Master FX

Master EQ

USB Monitor

Variation/Reverb/Master Effect Switch

Determines whether Variation/Reverb/Master Effect is active or not.

Settings: Off, On

Category (Variation/Reverb/Master Effect Category)**Type (Variation/Reverb/Master Effect Type)**

Determines the category and type for the selected effect.

Settings: For details on the editable Effect categories and types, see the Data List PDF document. Also, for details on the description for each Effect type, see the Synthesizer Parameter Manual PDF document.

Preset (Variation/Reverb/Master Effect Preset)

Allows you to call up pre-programmed settings for each Variation/Reverb/Master Effect type, designed to be used for specific applications and situations.

Settings: For a list of all Preset Effect Types, see the Data List PDF document.

Side Chain/Modulator (Variation/Master Effect Side Chain/Modulator Part)

Determines the Part used for Side Chain/Modulator for Variation/Master Effect.

This is not available when you select the same Part or "Master" as the Modulator Part.

Settings: Part 1–16, A/D, Master, Off

Var Return (Variation Return)**Rev Return (Reverb Return)**

Determines the return level of the Variation/Reverb effect.

Settings: 0–127

Var Pan (Variation Pan)**Rev Pan (Reverb Pan)**

Determines the pan position of the Variation/Reverb effect.

Settings: L63 (far left)–C (center)–R63 (far right)

Var to Rev (Variation to Reverb)

Determines the Send level of the signal sent from the Variation Effect to the Reverb Effect.

Settings: 0–127

Master EQ (Master Equalizer Switch)

Determines whether the Master EQ is active or not.

Settings: Off, On

Envelope Follower

Calls up the Envelope Follower setting display. See the Routing display ([page 75](#)) for the Normal Part (AWM2).

Variation

From this display you can determine the detailed settings of the Variation effect.

Operation [PERFORMANCE (HOME)] → [EDIT] → [Effect] → [Variation]

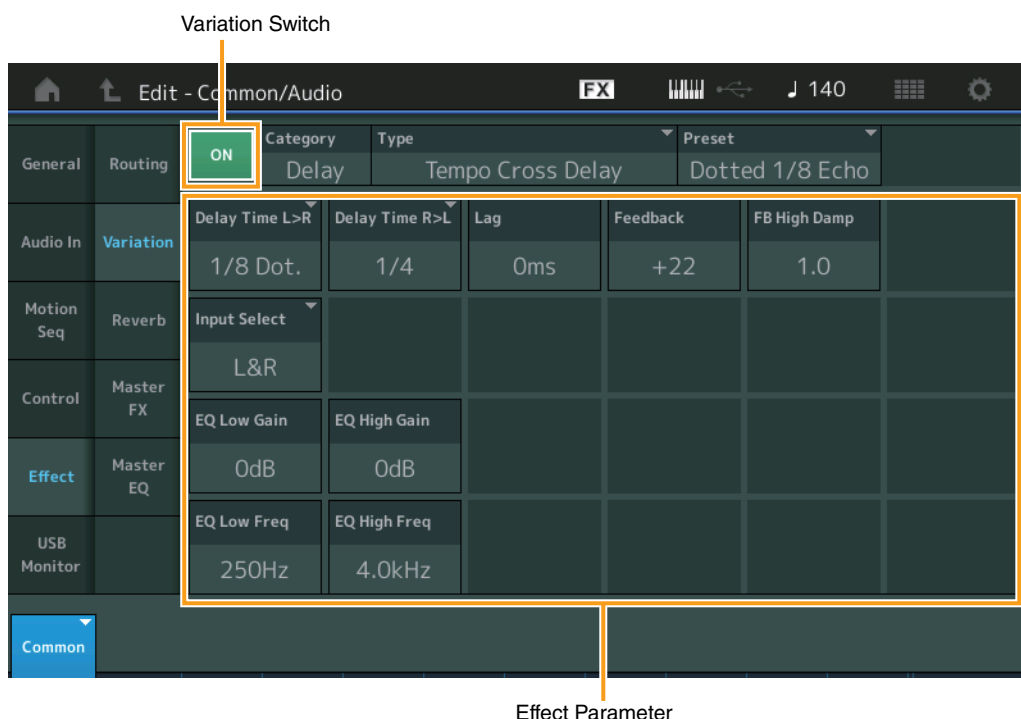
**Variation Switch**

Determines whether the Variation effect is active or not.

Settings: Off, On

Category (Variation Category)**Type (Variation Type)**

Determines the category and type for the selected effect.

Settings: For details on the editable Effect categories and types, see the Data List PDF document. Also, for details on the description for each Effect type, see the Synthesizer Parameter Manual PDF document.

Preset (Variation Preset)

Allows you to call up pre-programmed settings for each Effect type, designed to be used for specific applications and situations.

Settings: For a list of all Preset Effect Types, see the Data List PDF document.

Common/Audio Edit

Common/Audio

General

Audio In

Mixing

Routing

Ins A

Ins B

EQ

Motion Seq

Common

Lane

Control

Control Assign

Control Number

Effect

▶ Routing

▶ Variation

Reverb

Master FX

Master EQ

USB Monitor

Side Chain/Modulator (Variation Effect Side Chain/Modulator Part)

Determines the Part used for Side Chain/Modulator for Variation Effect.

This is not available when you select the same Part or "Master" as the Modulator Part.

Settings: Part 1–16, A/D, Master, Off

Effect Parameter

Editable parameters differ depending on the selected Effect Types. For details on the editable Effect parameters for each Effect Type, see the Data List PDF document. Also, for details on the description for each Effect parameter, see the Synthesizer Parameter Manual PDF document.

Reverb

From this display you can determine the detailed settings of the Reverb effect.

Operation [PERFORMANCE (HOME)] → [EDIT] → [Effect] → [Reverb]

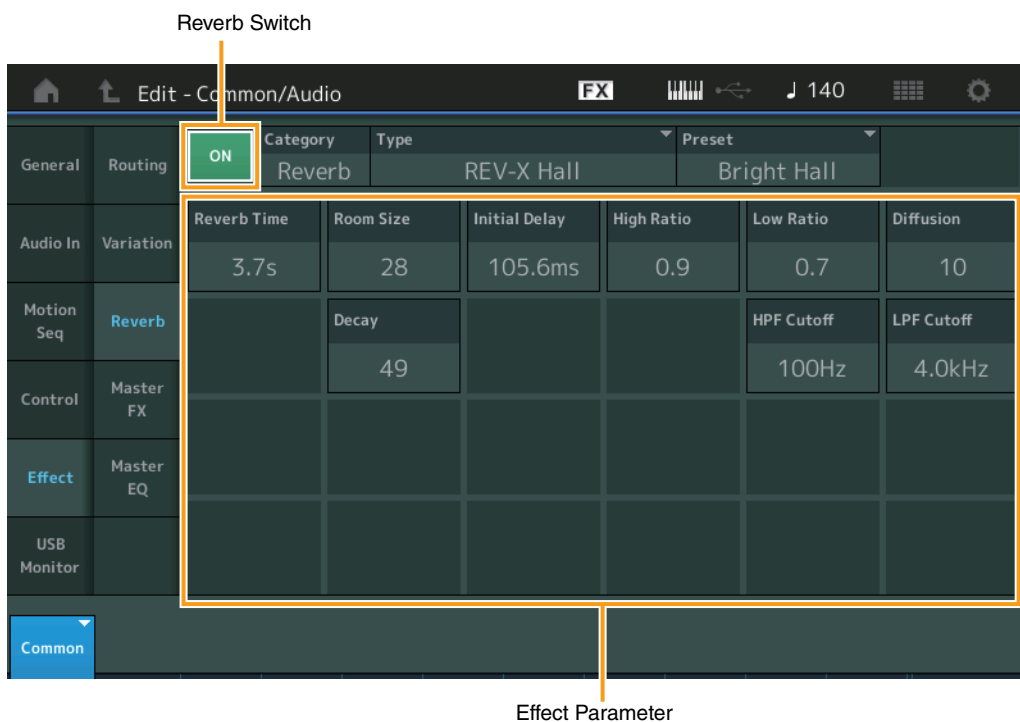

Reverb Switch

Determines whether the Reverb effect is active or not.

Settings: Off, On

Category (Reverb Category)

Type (Reverb Type)

Determines the category and type for the selected effect.

Settings: For details on the editable Effect categories and types, see the Data List PDF document. Also, for details on the description for each Effect type, see the Synthesizer Parameter Manual PDF document.

Preset (Reverb Preset)

Allows you to call up pre-programmed settings for each Effect type, designed to be used for specific applications and situations.

Settings: For a list of all Preset Effect Types, see the Data List PDF document.

Effect Parameter

Editable parameters differ depending on the selected Effect Types. For details on the editable Effect parameters for each Effect Type, see the Data List PDF document. Also, for details on the description for each Effect parameter, see the Synthesizer Parameter Manual PDF document.

Common/Audio Edit

Common/Audio

General

Audio In

Mixing

Routing

Ins A

Ins B

EQ

Motion Seq

Common

Lane

Control

Control Assign

Control Number

Effect

Routing

Variation

Reverb

Master FX

Master EQ

USB Monitor

Master FX (Master Effect)

From this display you can determine the detailed settings of the Master Effect.

Operation [PERFORMANCE (HOME)] → [EDIT] → [Effect] → [Master FX]



Common/Audio Edit

Common/Audio

General

Audio In

Mixing

Routing

Ins A

Ins B

EQ

Motion Seq

Common

Lane

Control

Control Assign

Control Number

Effect

Routing

Variation

Reverb

▶ Master FX

Master EQ

USB Monitor

Master Effect Switch

Determines whether the Master Effect is active or not.

Settings: Off, On

Category (Master Effect Category)

Type (Master Effect Type)

Determines the category and type for the selected effect.

Settings: For details on the editable Effect categories and types, see the Data List PDF document. Also, for details on the description for each Effect type, see the Synthesizer Parameter Manual PDF document.

Preset (Master Effect Preset)

Allows you to call up pre-programmed settings for each Effect type, designed to be used for specific applications and situations.

Settings: For a list of all Preset Effect Types, see the Data List PDF document.

Side Chain/Modulator (Master Effect Side Chain/Modulator Part)

Determines the Part used for Side Chain/Modulator for Master Effect.

This is not available when you select the same Part or "Master" as the Modulator Part.

Settings: Part 1–16, A/D, Master, Off

Effect Parameter

Editable parameters differ depending on the selected Effect Types. For details on the editable Effect parameters for each Effect Type, see the Data List PDF document. Also, for details on the description for each Effect parameter, see the Synthesizer Parameter Manual PDF document.

Master EQ (Master Equalizer)

From this display you can set parameters related to the Master EQ.

Operation [PERFORMANCE (HOME)] → [EDIT] → [Effect] → [Master EQ]

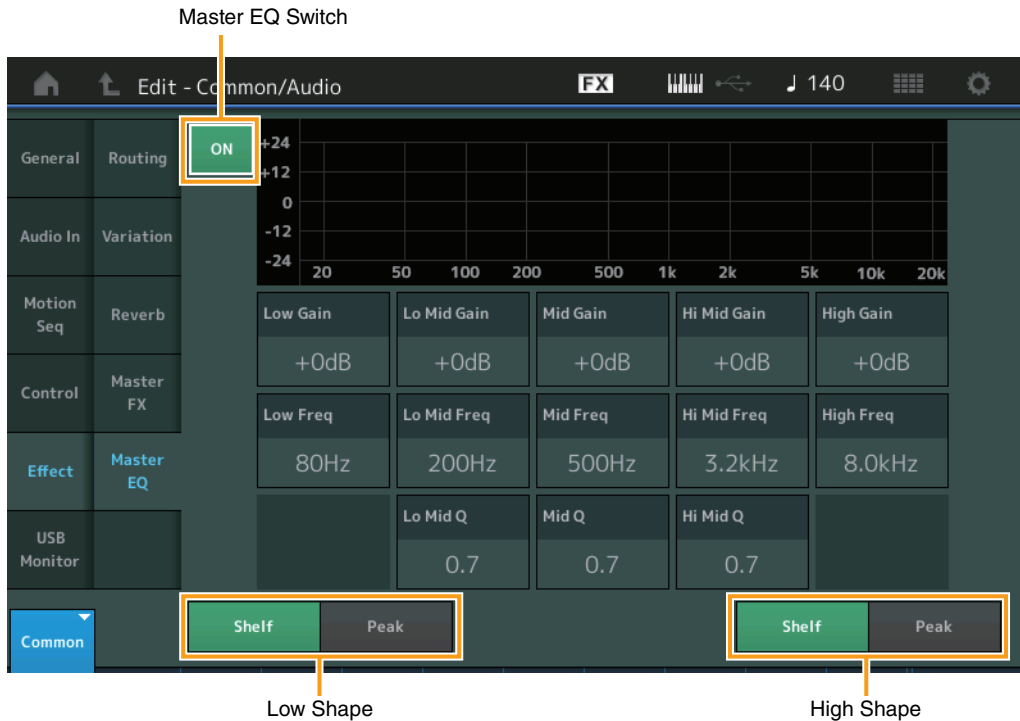

Common/Audio Edit

Common/Audio

General

Audio In

Mixing

Routing

Ins A

Ins B

EQ

Motion Seq

Common

Lane

Control

Control Assign

Control Number

Effect

Routing

Variation

Reverb

Master FX

▶ Master EQ

USB Monitor

Master EQ Switch

Determines whether the Master EQ is active or not.

Settings: Off, On

Low Gain (Master EQ Low Gain)

Determines the level gain of the Master EQ Low band.

Settings: -12dB – +12dB

Lo Mid Gain (Master EQ Low Mid Gain)

Determines the level gain of the Master EQ Low Mid band.

Settings: -12dB – +12dB

Mid Gain (Master EQ Mid Gain)

Determines the level gain of the Master EQ Mid band.

Settings: -12dB – +12dB

Hi Mid Gain (Master EQ High Mid Gain)

Determines the level gain of the Master EQ High Mid band.

Settings: -12dB – +12dB

High Gain (Master EQ High Gain)

Determines the level gain of the Master EQ High band.

Settings: -12dB – +12dB

Low Freq (Master EQ Low Frequency)

Determines the frequency for the Master Low band.

Settings: 32Hz–2.0kHz

Lo Mid Freq (Master EQ Low Mid Frequency)

Determines the frequency for the Master Low Mid band.

Settings: 100Hz–10kHz

Mid Freq (Master EQ Mid Frequency)

Determines the frequency for the Master Mid band.

Settings: 100Hz–10kHz

Hi Mid Freq (Master EQ High Mid Frequency)

Determines the frequency for the Master High Mid band.

Settings: 100Hz–10kHz

High Freq (Master EQ High Frequency)

Determines the frequency for the Master High band.

Settings: 500Hz–16kHz

Low Q (Master EQ Low Q)

Determines the EQ bandwidth of the Master Low band. This is available only when the Master EQ Low Shape (below) is set to "Peak."

Settings: 0.1–12.0

Lo Mid Q (Master EQ Low Mid Q)

Determines the EQ bandwidth of the Master Low Mid band.

Settings: 0.1–12.0

Mid Q (Master EQ Mid Q)

Determines the EQ bandwidth of the Master Mid band.

Settings: 0.1–12.0

Hi Mid Q (Master EQ High Mid Q)

Determines the EQ bandwidth of the Master High Mid band.

Settings: 0.1–12.0

High Q (Master EQ High Q)

Determines the EQ bandwidth of the Master High band. This is available only when the Master EQ High Shape (below) is set to "Peak."

Settings: 0.1–12.0

Low Shape (Master EQ Low Shape)**High Shape (Master EQ High Shape)**

Determines whether the equalizer type used is Shelving or Peaking. The Peaking type attenuates/boosts the signal at the specified Frequency setting, whereas the Shelving type attenuates/boosts the signal at frequencies above or below the specified Frequency setting. This parameter is available only for the LOW and HIGH frequency bands.

Settings: Shelf (Shelving Type), Peak (Peaking Type)

Common/Audio Edit

Common/Audio

General

Audio In

Mixing

Routing

Ins A

Ins B

EQ

Motion Seq

Common

Lane

Control

Control Assign

Control Number

Effect

Routing

Variation

Reverb

Master FX

▶ Master EQ

USB Monitor

USB Monitor

From the USB Monitor display, you can adjust the Audio Input level from the [USB TO HOST] terminal.

NOTE USB Main Monitor Volume is stored as Performance Data.

Operation [PERFORMANCE (HOME)] → [EDIT] → [USB Monitor]

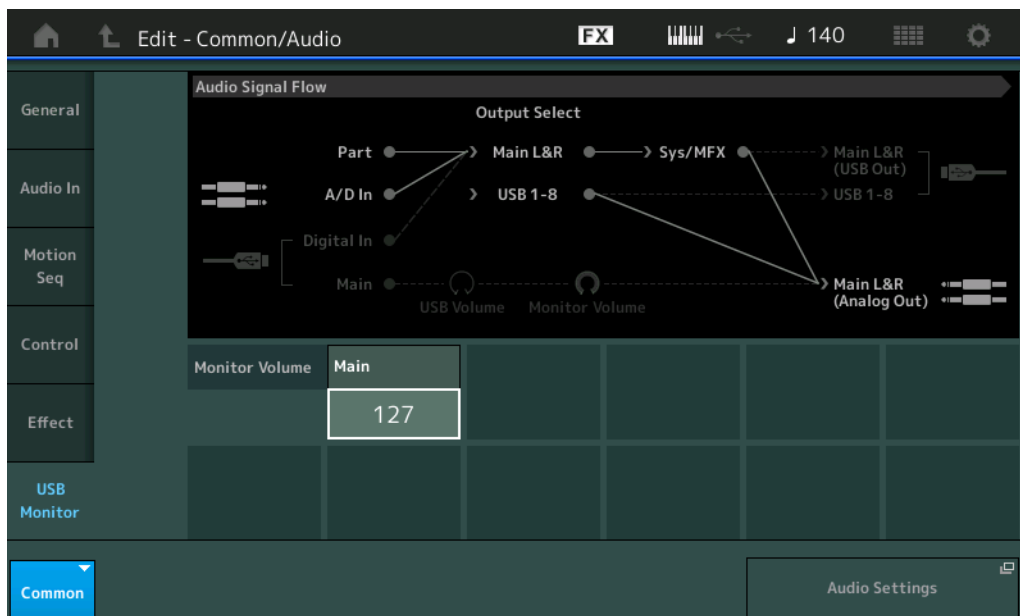

USB Main Monitor Volume

Adjusts the Audio signal level which is input from the [USB TO HOST] terminal and output to the OUTPUT [L/MONO]/[R] jacks.

Settings: 0-127

Audio Settings

Calls up the Audio I/O display in Utility.

Common/Audio Edit

Common/Audio

General

Audio In

Mixing

Routing

Ins A

Ins B

EQ

Motion Seq

Common

Lane

Control

Control Assign

Control Number

Effect

Routing

Variation

Reverb

Master FX

Master EQ

▶ USB Monitor

Category Search

The Performances/Arpeggios/Waveforms are conveniently divided into specific Categories. The categories are divided based on the general instrument type or sound characteristics. The Category Search function gives you quick access to the sounds you want.

The Favorite function has been added, giving you quick access to desired sounds and Arpeggios.

NOTE You can filter the Performance List by Favorite in the Part Category Search and in the Performance Merge, but you cannot turn the Favorite icon on/off from the search displays.

Performance Category Search

From the Performance Category Search display you can search and select the Performance.

■ In case of Performance Category Search

Operation

[PERFORMANCE (HOME)] → [CATEGORY] (Performance Category Search)
or
Touch the Performance Name → Select [Category Search] from the displayed menu

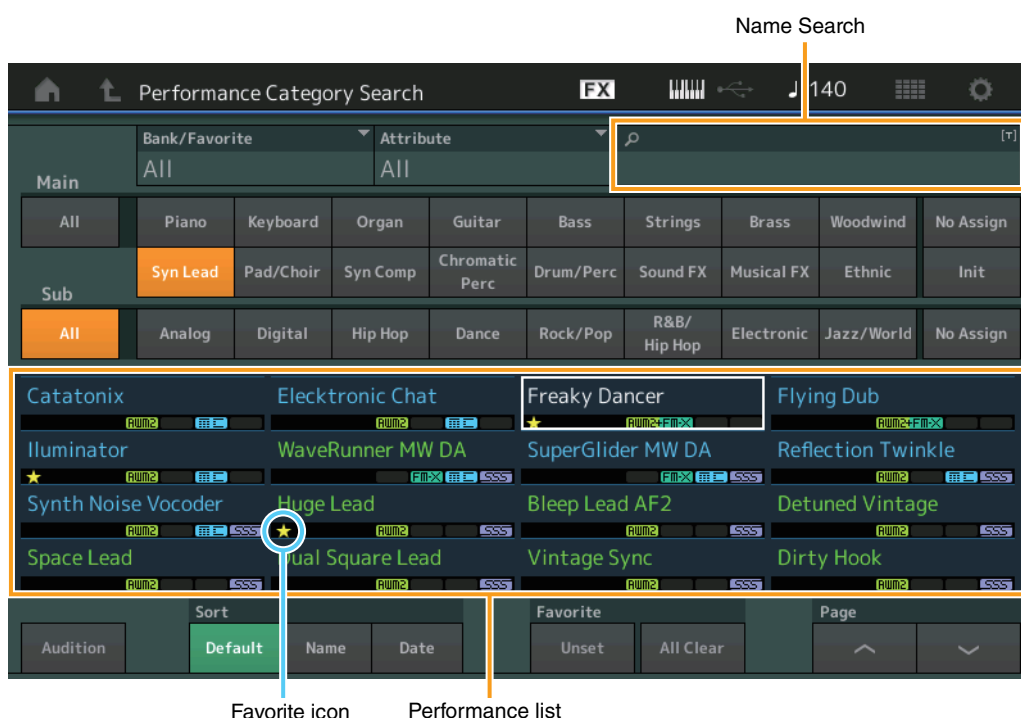

Bank/Favorite (Performance Bank Select/Favorite)

Filters the Performance List by Bank or Favorite. When Favorite is selected, only Performances having a Favorite icon are listed.

Settings: All, Favorite, Preset, User, Library Name (when the Library file is read)

NOTE When the Category Search display is selected, pressing the [CATEGORY] button repeatedly switches Banks among All, Favorite, Preset, User, Library (when the Library file is read). Holding down the [CATEGORY] button lets you go back to All.

Attribute (Performance Attribute)

Filters the Performance List by Attribute ([page 159](#)). This is not available for Part Category Search.

Settings: All, AWM2, FM, AWM2+FM-X, MC, SSS, Single, Multi

Name Search (Performance Name Search)

Searches the Performance by inputting a part of the Performance Name.

Settings: See the Data List PDF document.

Search

▶ Performance Category

Arp Category

Waveform

Rhythm Pattern

Main (Performance Main Category)

Settings: See the Data List PDF document.

Sub (Performance Sub Category)

Settings: See the Data List PDF document.

Audition (Audition Switch)

Determines whether the Audition phrase is played back or not. This is not available when “Audition Lock” (page 193) is set to on in the Utility display.

Settings: Off, On

Sort (Sort Order)

Determines the Sort Order of the Performance List.

Settings: Default, Name, Date

Name: Sorts by name. When the lower arrow is displayed, the List is arranged in ascending order (A to Z). When the upper arrow is displayed, the List is arranged in descending order.

Date: Sorts in order of storing. When the lower arrow is displayed, the List is arranged in descending order (newer to older). When the upper arrow is displayed, the List is arranged in ascending order.

Favorite Set / Unset

Enters (Sets) or cancels (Unsets) the Favorite icon to the currently selected Performance. This is not available when the cursor is not on the Performance List.

NOTE You can also set/unset the Favorite icon from the menu which is displayed by touching the Performance name on the Performance Play (Home) display.

Favorite All Clear

Clears all Favorite icons on Performances. This is available only when at least one Performance has a Favorite icon.

Search

▶ Performance Category

Arp Category

Waveform

Rhythm Pattern

■ In case of Part Category Search

You can select any Part in a Performance and assign the sound of the Part to another.

When “Mixing” of the “Parameter with Part” (Param. with Part) setting is set to off, you can change sounds continuously, using the current setting values for the Part such as Volume, Pan and Note shift.

Operation

[PERFORMANCE (HOME)] → (When the Part to which any sounds are assigned is selected) Select the Part Name → [SHIFT]+[CATEGORY] (Part Category Search)
or
(When the Part to which any sounds are assigned is selected) Touch the Part Name → Select [Category Search] from the displayed menu

When the selected Part and all succeeding Parts have no sound assigned (or are empty), executing the operation above opens the Performance Merge display.

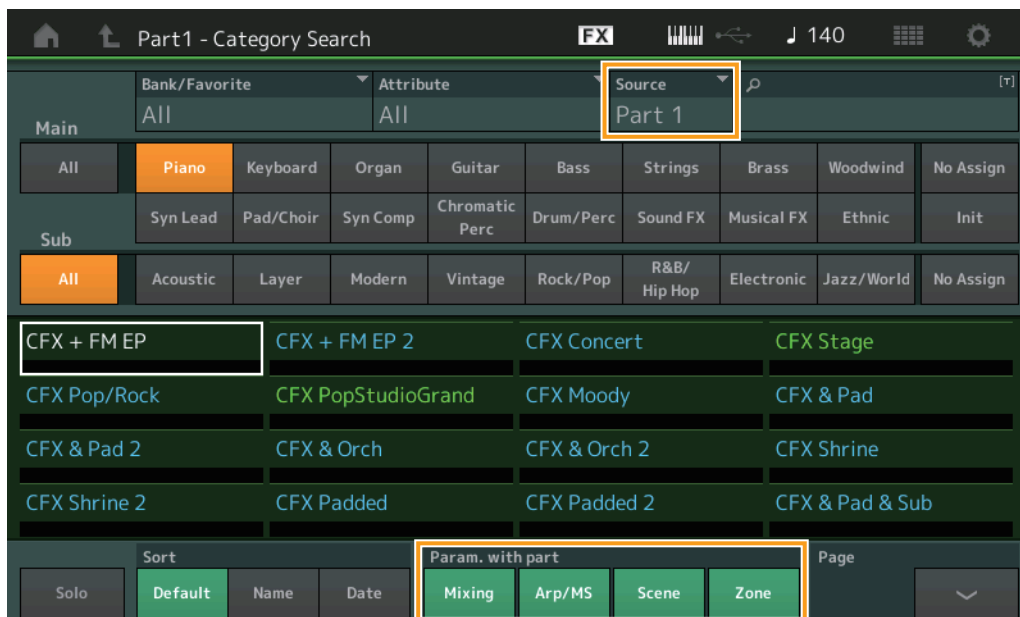

Source

Determines which Part of the selected Performance will be assigned to the Performance being edited.

Settings: Part 1–16

Solo (Solo Switch)

Determines the Solo function is active (On) or not (Off.) When this is set to on and any sound is assigned to the Part, only the Part will be sounded.

Settings: Off, On

Param. with part (Parameter with Part)

Determines whether or not to read and use the parameter values for the next Performance. When the set of parameters is set to off, the current setting values are continuously used even when the next Performance is selected.

The “Zone” parameter is available only when “Zone Master” ([page 193](#)) is set to on in the Utility display.

Settings: Off, On

Search

▶ Performance Category

Arp Category

Waveform

Rhythm Pattern

■ Performance Merge

From the Performance Merge display, you can collectively assign multiple Parts from the selected Performance to empty Parts in the Performance currently being edited. For example, you can merge four Piano Parts in one Performance and two Strings Parts in another Performance to create even more richly textured, layered sounds.

This allows you to separately mute original Parts and newly added Parts.

Operation

[PERFORMANCE (HOME)] → (the selected Part and all Parts that follow must not be assigned) → [SHIFT] + [CATEGORY] or touch the “+” icon

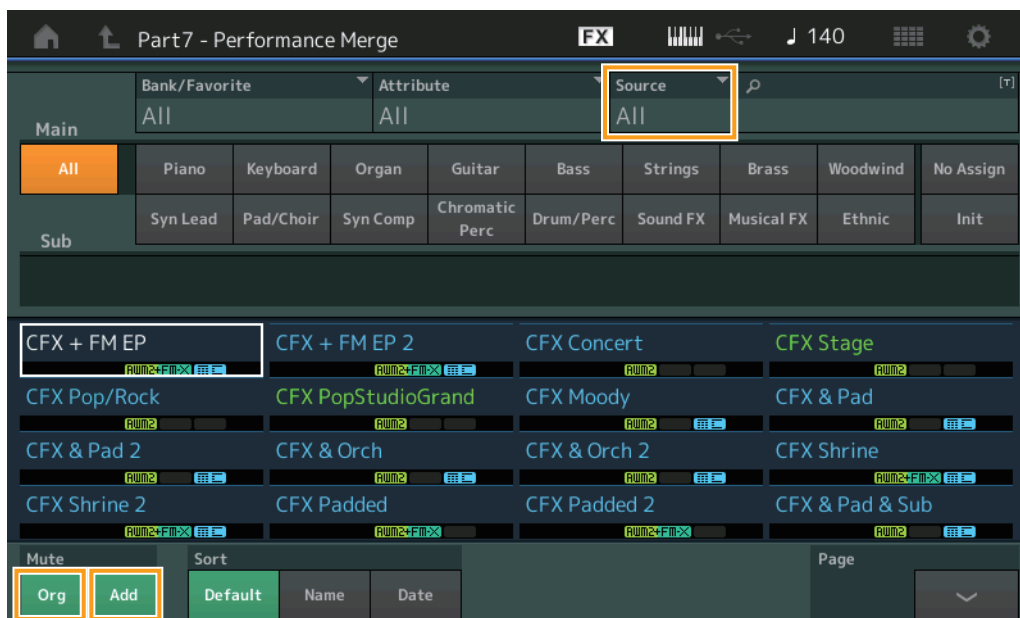

Original Part Mute

Additional Part Mute

Source

Determines which Part of the selected Performance will be assigned to the Performance being edited.

Settings: All, Part 1–16

All: All non-empty Parts of the selected Performance are assigned to available empty Parts.

Part 1–16: Only the sound from the specified Part is assigned to the selected Part.

Original Part Mute

When set to OFF, all of the Parts existed before adding any Parts in the Performance Merge display will be muted.

Settings: Off, On

Additional Part Mute

When set to OFF, only the Part added in the Performance Merge display will be muted.

Settings: Off, On

Search

▶ Performance Category

Arp Category

Waveform

Rhythm Pattern

Arpeggio Category Search (Arp Category Search)

From the Arpeggio Category Search display you can search and select Arpeggio Types.

Operation Arpeggio related display → Part selection → [CATEGORY]

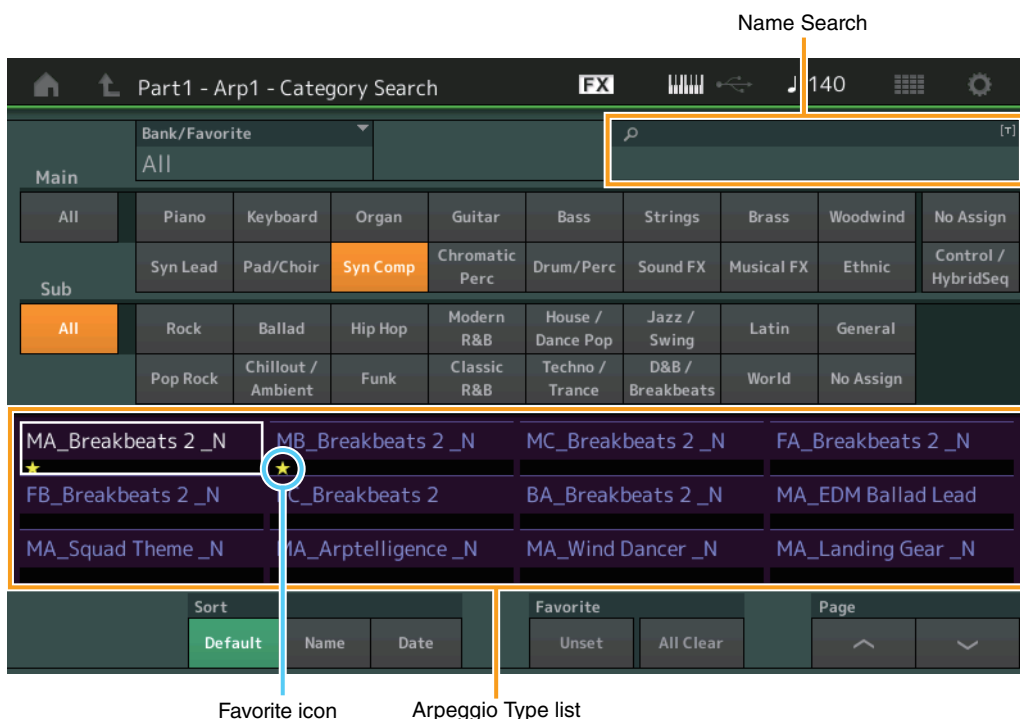

Favorite icon

Arpeggio Type list

Bank/Favorite (Performance Bank Select/Favorite)

Filters the Performance List by Bank or Favorite. When Favorite is selected, only Performances having a Favorite icon are listed.

Settings: All, Favorite, Preset, User, Library Name (when the Library file is read)

When the Category Search display is selected, pressing the [CATEGORY] button repeatedly switches Banks among All, Favorite, Preset, User, Library (when the Library file is read). Holding down the [CATEGORY] button lets you go back to All.

Name Search (Arpeggio Name Search)

Searches for an Arpeggio by inputting a part of the Arpeggio Name.

Settings: See the Data List PDF document.

Main (Arpeggio Category)

Settings: See the Arpeggio Category List (page 11).

Sub (Arpeggio Sub Category)

Settings: See the Arpeggio Sub Category List (page 11).

Sort (Sort Order)

Determines the Sort Order of the Arpeggio Type List.

Settings: Default, Name, Date

Name: Sorts by name. When the lower arrow is displayed, the List is arranged in ascending order (A to Z). When the upper arrow is displayed, the List is arranged in descending order.

Date: Sorts in order of loading. When the lower arrow is displayed, the List is arranged in descending order (newer to older). When the upper arrow is displayed, the List is arranged in ascending order.

Favorite Set / Unset

Enters (Sets) or cancels (Unsets) the Favorite icon to the currently selected Performance. This is not available when the cursor is not on the Performance List.

Search

Performance Category

▶ Arp Category

Waveform

Rhythm Pattern

Favorite All Clear

Clears all Favorite icons on Performances. This is available only when at least one Performance has a Favorite icon.

Page (Page Select)

When Files in “File Select” are displayed in multiple pages, you will need to use this button to scroll through the pages.

Search

Performance Category**▶ Arp Category**

Waveform

Rhythm Pattern

Waveform Category Search (Waveform Search)

From the Waveform Category Search display you can search and select the Waveforms.

Operation Waveform related display → Part selection → Waveform selection → [CATEGORY]

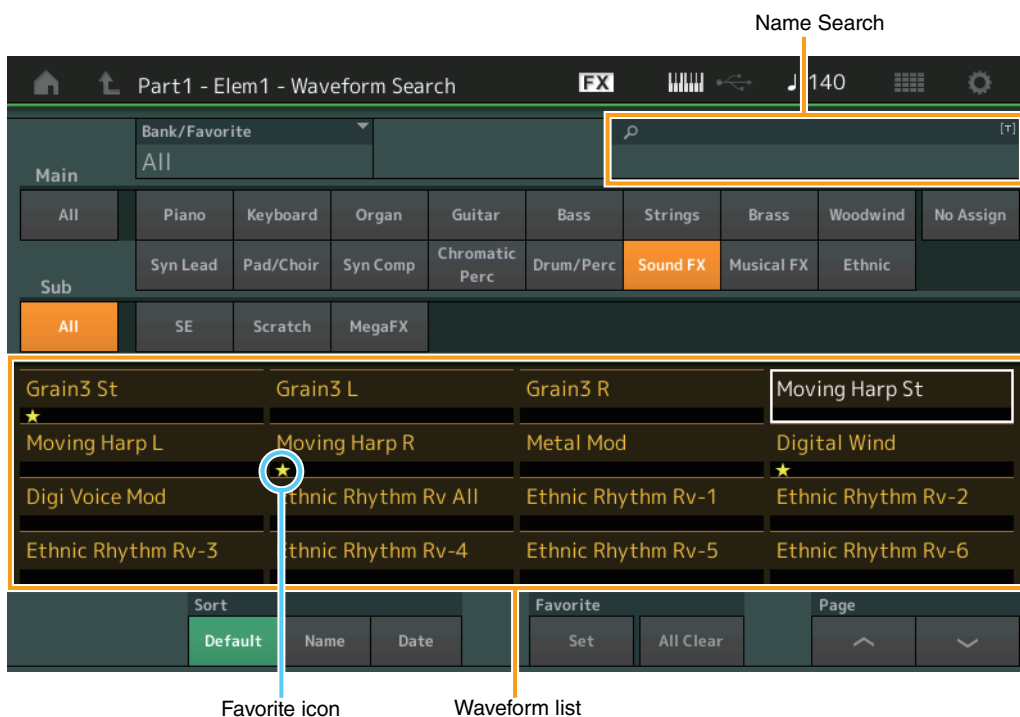

Search

Performance Category

Arp Category

▶ Waveform

Rhythm Pattern

Bank/Favorite (Performance Bank Select/Favorite)

Filters the Performance List by Bank or Favorite. When Favorite is selected, only Performances having a Favorite icon are listed.

Settings: All, Favorite, Preset, User, Library Name (when the Library file is read)

When the Category Search display is selected, pressing the [CATEGORY] button repeatedly switches Banks among All, Favorite, Preset, User, Library (when the Library file is read). Holding down the [CATEGORY] button lets you go back to All.

Name Search (Waveform Name Search)

Searches for a Waveform by inputting a part of the Waveform Name.

Settings: See the Data List PDF document.

Main (Waveform Category)

Settings: See the Data List PDF document.

Sub (Waveform Sub Category)

Settings: See the Data List PDF document.

Sort (Sort Order)

Determines the Sort Order of the Waveform List.

Settings: Default, Name, Date

Name: Sorts by name. When the lower arrow is displayed, the List is arranged in ascending order (A to Z). When the upper arrow is displayed, the List is arranged in descending order.

Date: Sorts in order of storing. When the lower arrow is displayed, the List is arranged in descending order (newer to older). When the upper arrow is displayed, the List is arranged in ascending order.

Favorite Set / Unset

Enters (Sets) or cancels (Unsets) the Favorite icon to the currently selected Performance. This is not available when the cursor is not on the Performance List.

Favorite All Clear

Clears all Favorite icons on Performances. This is available only when at least one Performance has a Favorite icon.

Page (Page Select)

When Files in “File Select” are displayed in multiple pages, you will need to use this button to scroll through the pages.

Search

Performance Category

Arp Category

▶ Waveform

Rhythm Pattern

Rhythm Pattern

Use this function to add and set up a Drum Part.

Operation [RHYTHM PART]

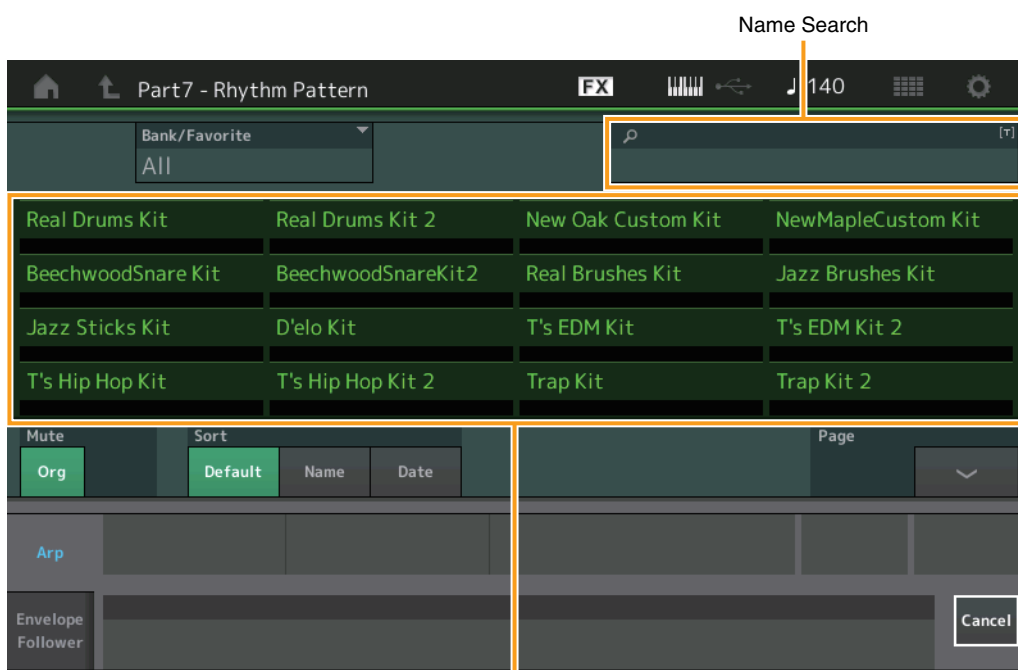

Rhythm Pattern List

Bank/Favorite (Rhythm Pattern Bank Select)

Filters the Rhythm Pattern List by Bank or Favorite.

Settings: All, Favorite, Preset, User, Library Name (when the Library file is read)

Name Search (Rhythm Pattern Name Search)

Searches the Rhythm Patterns by inputting a part of the Rhythm Pattern Name.

Original Part Mute

When set to OFF, all of the Parts existed before adding any Parts in the Rhythm Pattern display will be muted.

Settings: Off, On

Additional Part Mute

When set to OFF, only the Part added in the Rhythm Pattern display will be muted.

Settings: Off, On

Sort (Sort Order)

Determines the Sort Order of the Rhythm Pattern List.

Settings: Default, Name, Date

Name: Sorts by name. When the lower arrow is displayed, the List is arranged in ascending order (A to Z). When the upper arrow is displayed, the List is arranged in descending order.

Date: Sorts in order of storing. When the lower arrow is displayed, the List is arranged in descending order (newer to older). When the upper arrow is displayed, the List is arranged in ascending order.

Page (Page Select)

When Files in "File Select" are displayed in multiple pages, you will need to use this button to scroll through the pages.

Cancel

Touching this button or pressing the [RHYTHM PATTERN] button cancels the selection and closes the Rhythm Pattern display.

Search

Performance Category

Arp Category

Waveform

▶ Rhythm Pattern

■ Arpeggio Tab

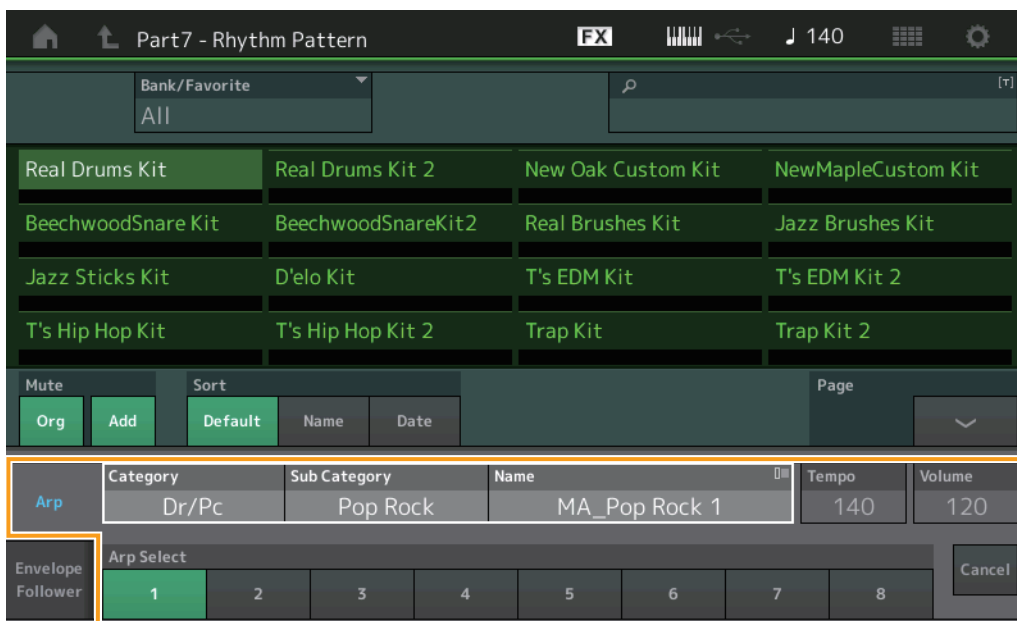

Arpeggio Tab

Arp Category (Arpeggio Category)

Arp Sub Category (Arpeggio Sub Category)

Arp Name (Arpeggio Name)

Arp Select (Arpeggio Select)

Same as the Individual display for Arpeggio ([page 85](#)).

Tempo

Determines the Rhythm Part tempo.

Settings: 5–300

Volume

Determines the Rhythm Part volume.

Settings: 0–127

Search

Performance Category

Arp Category

Waveform

▶ Rhythm Pattern

■ Envelope Follower Tab

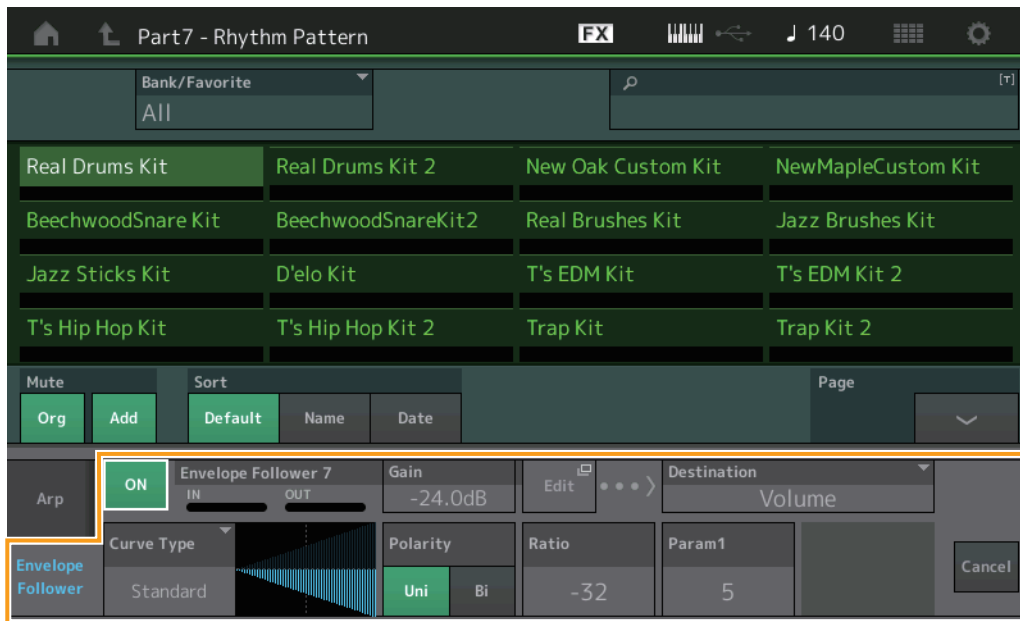

Envelope Follower Tab

Envelope Follower Switch

Determines whether the Envelope Follower is used (on) or not (off).

Settings: Off, On

Envelope Follower Gain

Same as the parameter in the Envelope Follower display ([page 21](#)).

Edit

Opens the Envelope Follower setting display.

Destination

Settings: Volume, Cutoff, Resonance, Pitch, Pan, Reverb Send, Variation Send, LFO Speed, LFO Depth 1, LFO Depth 2, LFO Depth 3

Curve Type

Curve Polarity

Curve Ratio

Same as the parameters in the Control Assign display ([page 100](#)).

Curve Parameter 1

Curve Parameter 2

Settings: 0–127

NOTE This parameter is not available depending on the Curve Type.

Search

Performance Category

Arp Category

Waveform

▶ Rhythm Pattern

Utility

The Utility display has four tabs; the Setting tab, the Contents tab, the Tempo Settings tab, the Effect Switch tab, and the Other Info tab. You can make various settings for the entire system.

Settings

Sound

From the Sound display you can make overall settings for the sounds output from the instrument.

Operation [UTILITY] → [Settings] → [Sound]

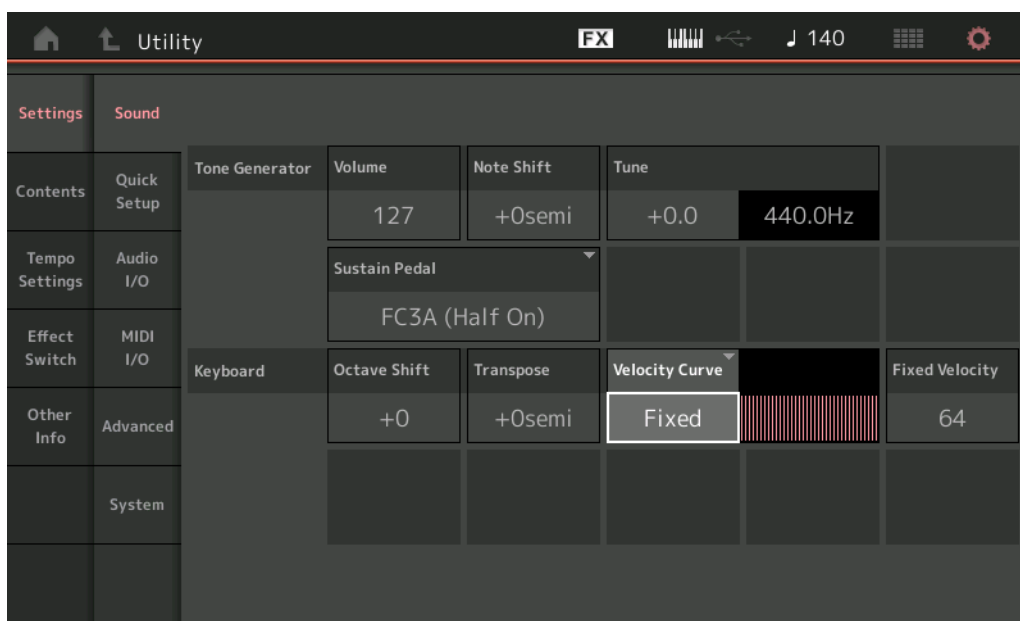

Tone Generator Volume

Determines the overall volume of the instrument.

Settings: 0–127

Tone Generator Note Shift

Determines the amount (in semitones) by which the pitch of all notes is shifted.

Settings: -24semi – +24semi

Tone Generator Tune

Determines the fine tuning of the instrument's overall sound (in 0.1 cent steps).

Settings: -102.4 – +102.3

Sustain Pedal (Foot Switch Sustain Pedal Select)

Selects the Foot switch type connected to the FOOT SWITCH [SUSTAIN] jack on the rear panel.

- **When the FC3 or FC3A is used:**

When you connect an optional FC3 or FC3A (equipped with the half-damper feature) for producing the special “half-damper” effect (as on a real acoustic piano), set this parameter to “FC3A (Half on).” If you don't need the half-damper feature or want to disable it while still using an FC3 or FC3A, set this parameter to “FC3A (Half off).”

- **When the FC4, FC4A, or FC5 is used:**

Select “FC4A/FC5.” The FC4, FC4A, and FC5 are not equipped with the half-damper feature.

Settings: FC3A (Half On), FC3A (Half Off), FC4A/FC5

NOTE Note that this setting is not necessary when controlling the half-damper feature via Control Change messages from an external MIDI device to the instrument.

Utility

Settings

- ▶ Sound
 - Quick Setup
 - Audio I/O
 - MIDI I/O
 - Advanced
 - System

Contents

- Load
- Store / Save
- Data Utility
- Library Import

Tempo Settings

Effect Switch

Other Info

- Shift Function
- Legal Notices

Keyboard Octave Shift

Determines the amount in octaves by which the range of the keyboard is shifted up or down. This parameter is linked with the OCTAVE [-]/[+] buttons on the panel.

Settings: -3 – +3

Keyboard Transpose

This parameter is used to transpose the current zone in units of one semitone.

Settings: -11semi – +11semi

NOTE If you transpose beyond the note range limits (C -2 – G8), notes in the adjacent octaves will be used.

Keyboard Velocity Curve

These five curves determine how the actual velocity will be generated and transmitted according to the velocity (strength) with which you play notes on the keyboard. The graph shown in the display indicates the velocity response curve. (The horizontal line represents the received velocity values (strength of your playing), while the vertical line represents the actual velocity values transmitted to the internal/external tone generators.)

Settings: Normal, Soft, Hard, Wide, Fixed

Normal: This linear “curve” produces one-to-one correspondence between the strength of your keyboard playing (velocity) and the actual sound change.

Soft: This curve provides increased response, especially for lower velocities.

Hard: This curve provides increased response, especially for higher velocities.

Wide: This curve accentuates your playing strength by producing lower velocities in response to softer playing and louder velocities in response to harder playing. As such, you can use this setting to expand your dynamic range.

Fixed: This setting produces the same amount of sound change (set in Keyboard Fixed Velocity below), no matter what your playing strength. The velocity of the notes you play are fixed at the value set here.

Keyboard Fixed Velocity

The Fixed curve can be used to send a fixed velocity to the tone generator regardless of how hard or soft you play the keyboard. This parameter is only available if you select the “Fixed” Keyboard Velocity Curve above.

Settings: 1–127

Utility

Settings

- ▶ Sound
- ▶ Quick Setup
- Audio I/O
- MIDI I/O
- Advanced
- System

Contents

- Load
- Store / Save
- Data Utility
- Library Import

Tempo Settings

Effect Switch

Other Info

- Shift Function
- Legal Notices

Quick Setup

Using Quick Setup can instantly call up appropriate sequencer-related panel settings by selecting convenient preset setups, allowing you to simultaneously and instantly set a variety of important sequencer-related parameters.

Operation

[UTILITY] → [Settings] → [Quick Setup],
or
[SHIFT] + [UTILITY],
or
Touch the QUICK SETUP icon

QUICK SETUP icon

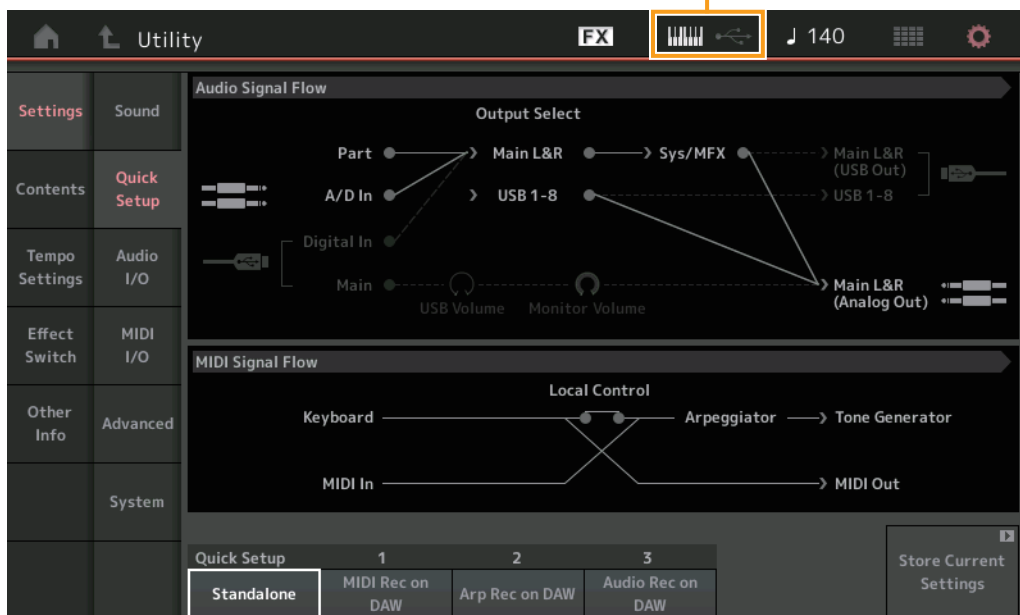

Audio Signal Flow

Indicates the Audio signal connections. The connections will change depending on the status of the [USB TO HOST] terminal and the general settings of the instrument.

MIDI Signal Flow

Indicates the MIDI signal connections. The connections will change depending on the general settings of the instrument.

Quick Setup

Determines the Quick Setups.

Settings: Standalone, 1–3

The parameters for Quick Setups are as follows.

Audio Settings	A/D Input Gain
	L&R Gain
	USB L&R Gain
	USB 1–8 Gain
	Direct Monitor Switch
MIDI Settings	MIDI In/Out
	Local Control
	Arp MIDI Out
	MIDI Sync
	Clock Out
	Receive/Transmit Sequencer Control
	Controller Reset
	FS CC Number
	Super Knob CC Number
	Scene CC Number
Part Output Settings	Part 1–16 Output Select
	A/D In Output Select
	Digital In Output Select

For details about parameters related to Audio Settings, see “Audio I/O” (page 190). For details about parameters related to MIDI Settings, see “MIDI I/O” (page 191).

The default settings for Quick Setups are as follows.

■ Standalone

Use this setting when this instrument is to be used alone or as the master clock source for other equipment.

Local Control	Direct Monitor	Output Select	Arp MIDI Out
On	On	Main L&R	Off

■ MIDI Rec on DAW

Use this setting when recording this instrument’s performance (not including Arpeggio data) to the DAW software.

Local Control	Direct Monitor	Output Select	Arp MIDI Out
Off	On	Main L&R	Off

■ Arp Rec on DAW

Use this setting when recording this instrument’s performance including Arpeggio data to the DAW software.

Local Control	Direct Monitor	Output Select	Arp MIDI Out
Off	On	Main L&R	On

Utility

Settings

Sound

▶ Quick Setup

Audio I/O

MIDI I/O

Advanced

System

Contents

Load

Store / Save

Data Utility

Library Import

Tempo Settings

Effect Switch

Other Info

Shift Function

Legal Notices

■ Audio Rec on DAW

Use this setting when recording the signals from the tone generator and the A/D INPUT [L/MONO]/[R] jacks separately to DAW software, and playing the signals from the OUTPUT [L/MONO]/[R] jacks directly.

Local Control	Direct Monitor	Output Select	Arp MIDI Out
On	Off	Depends on the Part	Off

The Output settings for Individual are as follows.

Part 1 Output Select	Main L&R
Part 2 Output Select	USB 1&2
--	--
Part 5 Output Select	USB 7&8
--	--
Part 16 Output Select	Main L&R
A/D In Output Select	Main L&R
Digital In Output Select	Main L&R

Store Current Settings

Stores the edited settings as 1–3 of “QuickSetup.”

Audio I/O

From the Audio I/O display you can set the parameters related to Audio Input and Output.

Operation [UTILITY] → [Settings] → [Audio I/O]

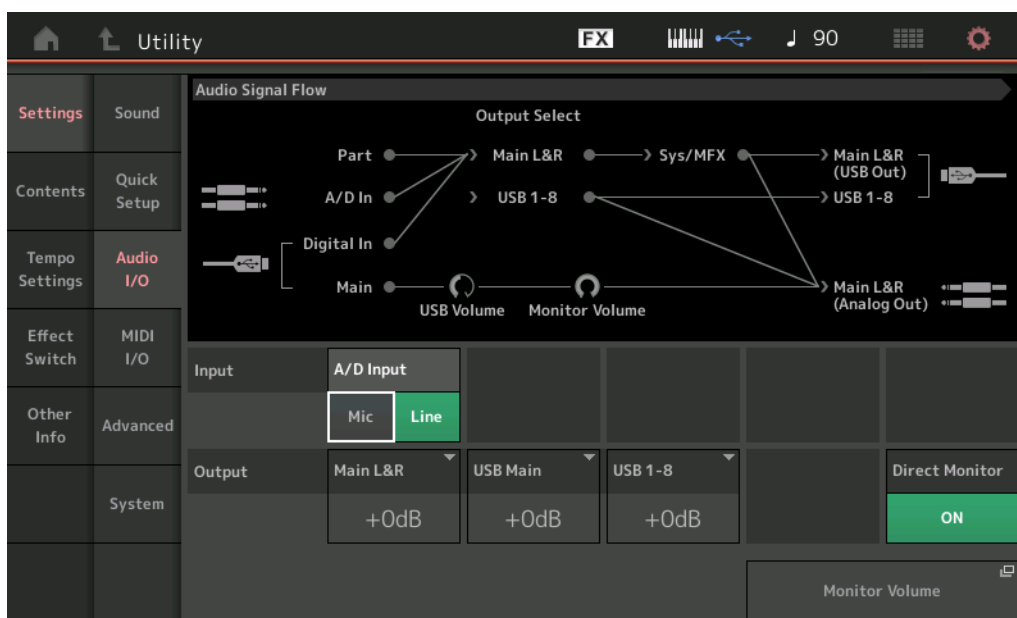

A/D Input (A/D Input Gain)

When using the A/D INPUT [L/MONO]/[R] jacks, this determines the input source, microphone (Mic) or Line.

Settings: Mic, Line

Mic: Intended for low output equipment, such as a microphone.

Line: Intended for high output equipment, such as a keyboard, synthesizer, or CD player.

NOTE A guitar or bass having active pickups can be directly connected. However, when using passive pickups, connect the instrument via an effect device.

Utility

Settings

Sound

▶ Quick Setup

▶ Audio I/O

MIDI I/O

Advanced

System

Contents

Load

Store / Save

Data Utility

Library Import

Tempo Settings

Effect Switch

Other Info

Shift Function

Legal Notices

Main L&R (Main L&R Output Gain)

Determines the output gain of the OUTPUT [L/MONO]/[R] jacks.

Settings: -6dB, +0dB, +6dB, +12dB

USB Main (USB Main L&R Output Gain)

Determines the output gain of the Main L&R channel of the [USB TO HOST] terminal.

Settings: -6dB, +0dB, +6dB, +12dB

USB 1-8 (USB 1–8 Output Gain)

Determines the output gain of 1–8 channels of the [USB TO HOST] terminal.

Settings: -6dB, +0dB, +6dB, +12dB

Direct Monitor (Direct Monitor Switch)

Determines whether or not the audio signal which is output to the external device via the “Main L&R,” “USB Main” or “USB 1-8” channels also sounds from this instrument (Direct Monitoring). When this is set to “on,” the audio signal which is output via the “Main L&R,” “USB Main” or “USB 1-8” channels is also output to the OUTPUT [L/MONO]/[R] jacks and [PHONES] jack. When the external device is not connected via USB cable, the Direct Monitor Switch is automatically turned on.

Settings: Off, On

Monitor Volume

Opens the USB Monitor setting display ([page 175](#)).

Utility

Settings

Sound

Quick Setup

▶ Audio I/O

▶ MIDI I/O

Advanced

System

Contents

Load

Store / Save

Data Utility

Library Import

Tempo Settings

Effect Switch

Other Info

Shift Function

Legal Notices

MIDI I/O

From the MIDI I/O display you can set parameters related to MIDI Input and Output. You can control the Super Knob or switch Scenes by Control Change messages.

Operation

[UTILITY] → [Settings] → [MIDI I/O]

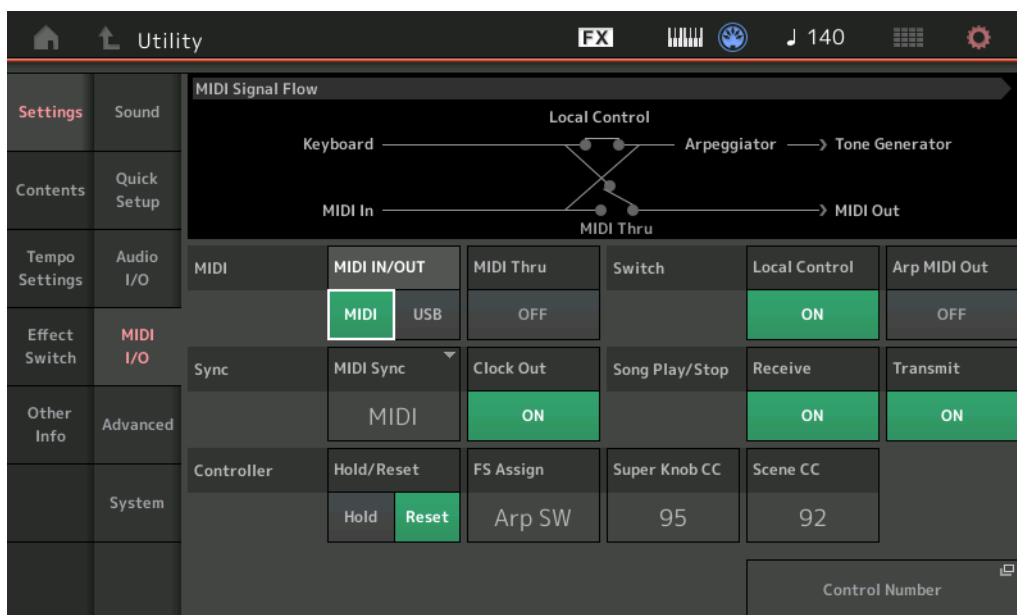

MIDI IN/OUT

Determines which physical output/input terminal(s) will be used for transmitting/receiving MIDI data.

Settings: MIDI, USB

NOTE The two types of terminals above cannot be used at the same time. Only one of them can be used to transmit/receive MIDI data.

MIDI Thru

Determines whether the MIDI [OUT] terminal will be used as a MIDI Thru terminal or not.

Settings: Off, on

Local Control

This determines whether or not the tone generator of the instrument responds to your keyboard playing. Normally, this should be set to “on”—since you’ll want to hear the sound of the instrument as you play it. Even if this is set to “off,” the data will be transmitted via MIDI. Also, the internal tone generator block will respond to messages received via MIDI.

Settings: Off, On

Arp MIDI Out (Arpeggio MIDI Out)

Determines whether to output MIDI data of Arpeggio playback or not.

Settings: Off, On

MIDI Sync

You can set various parameters related to MIDI clock and synchronization here.

Determines whether Arpeggio/Motion Sequencer/Song playback will be synchronized to the instrument’s internal clock, an external MIDI clock, or the Audio signal input from the A/D INPUT [L/MONO]/[R] jacks.

Settings: Internal, MIDI, A/D In

Internal: Synchronization to internal clock. You can use this setting when this tone generator is to be used alone or as the master clock source for other equipment.

MIDI: Synchronization to a MIDI clock received from an external MIDI instrument via MIDI. Use this setting when the external sequencer is to be used as master.

A/D In: Synchronization to the tempo of the Audio signal received via the A/D INPUT [L/MONO]/[R] jacks.

Clock Out

Determines whether MIDI clock messages will be transmitted via MIDI or not.

Settings: Off, On

Receive (Receive Sequencer Control)

Determines whether the Sequencer Control signals—start and stop of Song—will be received via MIDI or not.

Settings: Off, On

Transmit (Transmit Sequencer Control)

Determines whether the Sequencer Control signals—start and stop of Song—will be transmitted to MIDI or not.

Settings: Off, On

Hold/Reset (Controller Hold/Reset)

Determines the status of the controllers (Modulation Wheel, Aftertouch, Foot Controller, Breath Controller, Knobs, etc.) when switching between Performances. When this is set to “Hold,” the controllers are kept at the current setting. When this is set to “Reset,” the controllers are reset to the default states (below).

Settings: Hold, Reset

If you select “reset,” the controllers will be reset to the following states/positions:

Pitch Bend	Center
Modulation Wheel	Minimum
Aftertouch	Minimum
Foot Controller	Maximum
Foot Switch	Off
Ribbon Controller	Center
Breath Controller	Maximum
Expression	Maximum
Assignable Switches 1 and 2	Off
Motion Sequencer Hold	Off
Each Lane of Motion Sequencer	0 (minimum) when Lane Motion Sequencer Polarity is set to “Unipolar” 64 (center) when Lane Motion Sequencer Polarity is set to “Bipolar”

FS Assign (Foot Switch Assign Control Number)

Determines the Control Change number generated by using the Foot switch connected to the FOOT SWITCH [ASSIGNABLE] jack. Even when the instrument receives MIDI message with the same Control Change Number specified here from the external equipment, the instrument assumes that the message is generated by using the Foot switch.

Settings: Off, 1–95, Arp SW, MS SW, Play/Stop, Live Set+, Live Set-, Oct Reset

Utility

Settings

Sound

Quick Setup

Audio I/O

▶ MIDI I/O

Advanced

System

Contents

Load

Store / Save

Data Utility

Library Import

Tempo Settings

Effect Switch

Other Info

Shift Function

Legal Notices

Super Knob CC (Super Knob Control Change Number)

Determines the Control Change number generated by using the Super Knob. Even when the instrument receives MIDI messages with the same Control Change Number specified here from the external equipment, the instrument assumes that the message is generated by using the Super Knob. When "MIDI I/O Mode" is set to "Multi," Channel 1 is used for transmitting MIDI data. When "MIDI I/O Mode" is set to "Single," the channel specified in "MIDI I/O Ch." is used for transmitting MIDI data.

Settings: Off, 1–95

NOTE When this parameter is set to off, MIDI data is transmitted by SysEx (System Exclusive) messages.

Scene CC (Scene Control Change Number)

Determines the Control Change Number generated by switching Scenes. Even when the instrument receives MIDI message with the same Control Change Number specified here from the external equipment, the instrument assumes that the message is generated by switching Scenes.

Settings: Off, 1–95

NOTE Scene 1–8 is selected depending on the Control Change value.

0–15: Scene 1, 16–31: Scene 2, 32–47: Scene 3, 48–63: Scene 4, 64–79: Scene 5, 80–95: Scene 6, 96–111: Scene 7, 112–127: Scene 8

NOTE When the same Control Change Number is set to both of the Super Knob Control Change and the Scene Control Change, an exclamation mark (!) is shown before the value. In such a case, changes to Scene Control have priority and changes to the Super Knob Control are ignored.

Control Number

Calls up the Control Number display in the Common/Audio Edit.

Utility

Settings

Sound

Quick Setup

Audio I/O

▶ MIDI I/O

▶ Advanced

System

Contents

Load

Store / Save

Data Utility

Library Import

Tempo Settings

Effect Switch

Other Info

Shift Function

Legal Notices

Advanced

From the Advanced display you can set the advanced parameters. Data communication between this instrument and an external device using only the specified MIDI channel is also available.

Operation [UTILITY] → [Settings] → [Advanced]

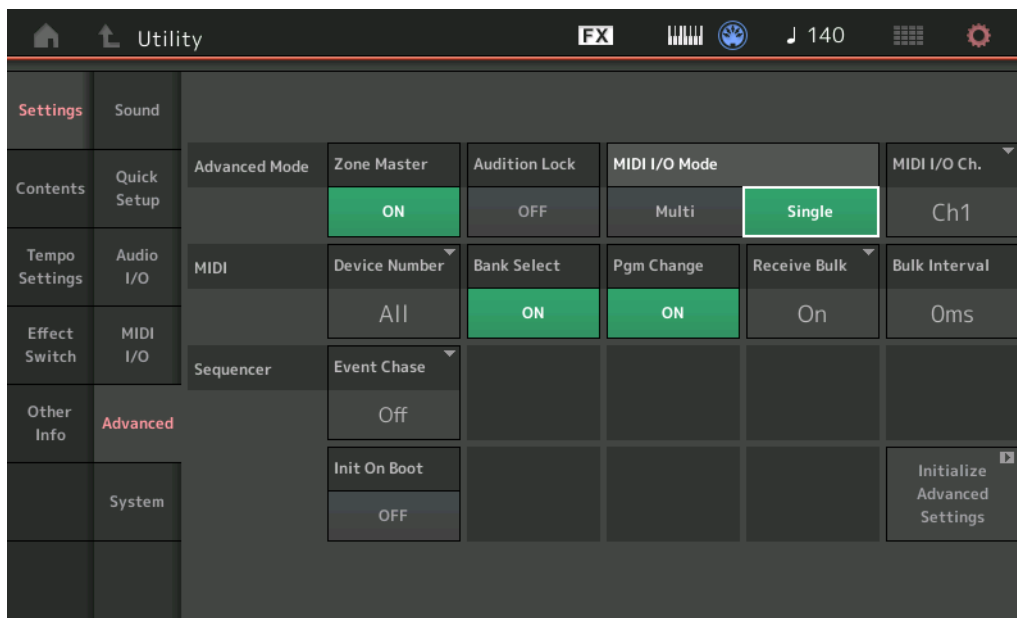

Zone Master (Zone Master Switch)

Determines whether the Zone function is used (on) or not (off).

Settings: Off, On

Audition Lock

Determines whether the Audition Lock is active or not. When this is set to On, the Audition function is not available.

Settings: Off, On

MIDI I/O Mode

Determines which MIDI I/O mode is used for data communication between this instrument and an external device.

Settings: Multi, Single

Multi: Transmits MIDI data such as Note On/Off messages for each Part.

Single: Transmits MIDI data using only the channel specified in "MIDI I/O Ch."

MIDI I/O Ch. (MIDI I/O channel)

Determines the MIDI channel to be used for data communication when "MIDI I/O Mode" is set to "Single."

Settings: Ch1–16

When this parameter is set to "Single," Arpeggio data is not transmitted to the external device. When the Zone function is active, the Zone setting for the Performance is given priority over the "MIDI I/O Mode" setting. You can see which setting is active from the MIDI Signal Flow in the MIDI I/O display.

Device Number

Determines the MIDI Device Number. This number must match the Device Number of the external MIDI device when transmitting/receiving bulk data, parameter changes or other System Exclusive messages.

Settings: 1–16, All, Off

Bank Select

This switch enables or disables Bank Select messages, both in transmission and reception. When this is set to "on," this synthesizer responds to incoming Bank Select messages.

Settings: Off, On

Pgm Change (Program Change)

This switch enables or disables Program Change messages, both in transmission and reception. When this is set to "on," this synthesizer responds to incoming Program Change messages.

Settings: Off, On

Receive Bulk

Determines whether or not Bulk Dump data can be received.

Settings: Protect (not received), On (received)

Bulk Interval

Determines the interval time of the Bulk Dump transmission when a Bulk Dump Request is received.

Settings: 0ms–900ms

Event Chase (Song Event Chase)

Event Chase allows you to specify which non-note data types are properly recognized during fast-forward and rewind operations. Setting this to a specific event ensures the playback integrity of the event, even when fast forwarding or rewinding.

Settings: Off, PC (Program Change), PC+PB+Ctrl (Program Change+Pitch Bend+Control Change)

Init On Boot (Initialize User Data on Boot-up)

Determines whether the User Data is initialized (On) or not (Off) when the power of the instrument is turned on.

Settings: Off, On

Initialize Advanced Settings

Initializes the system settings edited in the Advanced display.

NOTICE

When the Initialize operation is executed, the target data and system settings you edited will be erased. Make sure you are not overwriting any important data. Be sure to save all important data to your USB flash drive before executing this procedure.

Utility

Settings

Sound

Quick Setup

Audio I/O

MIDI I/O

▶ Advanced

System

Contents

Load

Store / Save

Data Utility

Library Import

Tempo Settings

Effect Switch

Other Info

Shift Function

Legal Notices

System

From the System display you can make global system settings for the instrument.

Operation [UTILITY] → [Settings] → [System]

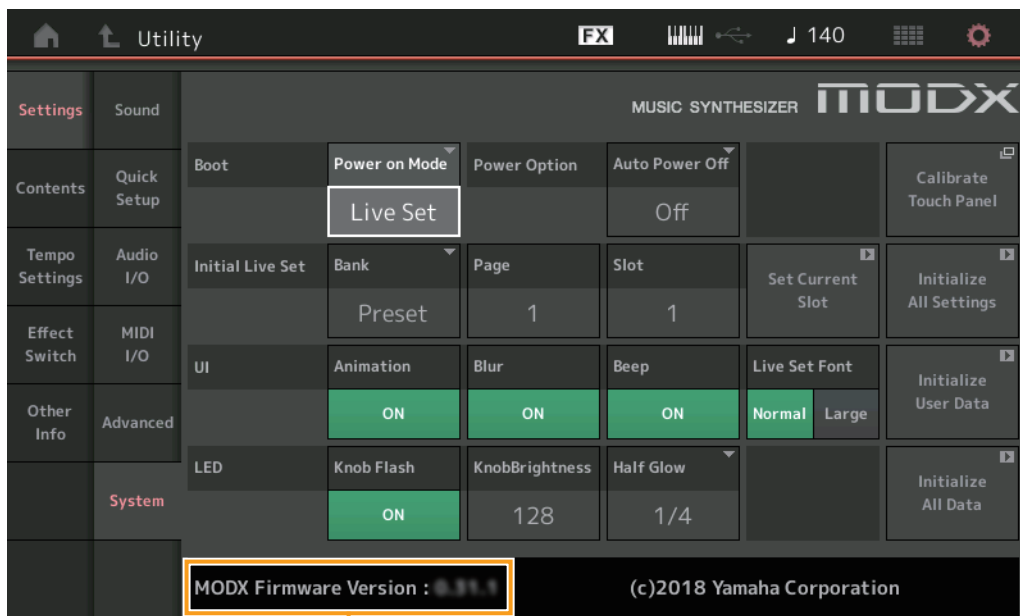

MODX Firmware version

Power on Mode

Determines the start-up display (which is automatically called up when power is turned on).

Settings: Perform, Live Set

Auto Power Off

To prevent unnecessary power consumption, this instrument features an Auto Power Off function that automatically turns the power off if the instrument is not operated for a specified period of time. This parameter determines the amount of time that elapses before the power is automatically turned off.

Settings: Off, 5, 10, 15, 30, 60, 120min

Initial Live Set Bank

Initial Live Set Page

Initial Live Set Slot

Selects the Live Set Bank, Page and Slot for the start-up display, for when the Power on Mode is set to "Live Set."

Settings: Bank: Preset, User1–User8, Library1–Library8

Page: 1–16

Slot: 1–16

Set Current Slot

Sets the currently selected Live Set Bank, Page and Slot to be displayed at startup.

Animation (Animation Switch)

Determines whether the animation of screen transition is turned on or off.

Settings: Off, On

Blur (Blur Switch)

When any display is selected, the display previously selected is blurred. This parameter determines whether the Blur function is turned on or off.

Settings: Off, On

Utility

Settings

Sound

Quick Setup

Audio I/O

MIDI I/O

Advanced

▶ System

Contents

Load

Store / Save

Data Utility

Library Import

Tempo Settings

Effect Switch

Other Info

Shift Function

Legal Notices

Beep (Beep Switch)

Determines whether the beep sound (that confirms operations, menu/parameter selection, etc.) is turned on or off.

Settings: Off, On

Knob Flash (Super Knob LED Switch)

Determines whether the flashing function of the Super Knob is turned on or off.

Settings: Off, On

KnobBrightness (Knob Brightness)

Controls the brightness of the lighting of the Super Knob.

Settings: 0–128

Half Glow (LED Half Glow Brightness)

Controls the dimming of the button lamps.

Settings: Off, 1/4, 1/2

Calibrate Touch Panel

Calls up the Calibration display for the Touch Panel. Calibration of the touch panel may be necessary if the touch panel does not respond correctly.

Initialize All Settings

Initializes all system settings you created on the Utility display.

Initialize User Data

Initializes User data (Performance, Motion Sequence, and Live Set) in the specified area of User memory.

Initialize All Data

Initializes all User data in the User memory and all system settings you created on the Utility display.

NOTICE

When the Initialize operation is executed, all target data and system settings you created will be erased. Make sure you are not overwriting any important data. Be sure to save all important data to your USB flash drive before executing this procedure.

MODX Firmware Version

Shows the version of the firmware installed on your MODX.

Live Set Font (Live Set Font Size)

Determines the font size of the contents name on the Live Set display and the Category Search display.

Settings: Normal, Large

Live Set display

- Normal

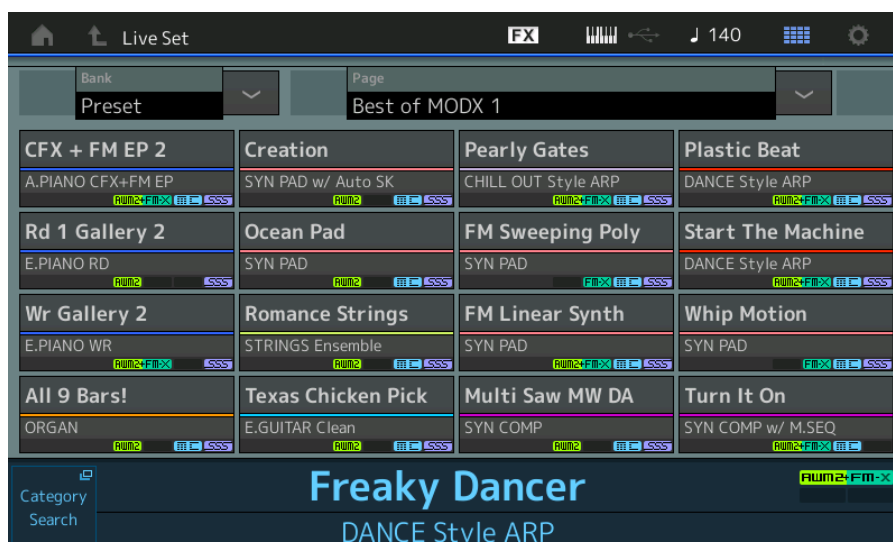

Utility

Settings

Sound

Quick Setup

Audio I/O

MIDI I/O

Advanced

▶ System

Contents

Load

Store / Save

Data Utility

Library Import

Tempo Settings

Effect Switch

Other Info

Shift Function

Legal Notices

- Large

Live Set

Bank: Preset Page: Best of MODX 1

CFX + FM EP 2 A.PIANO CFX+FM EP	Creation SYN PAD w/ Auto SK	Pearly Gates CHILL OUT Style ARP	Plastic Beat DANCE Style ARP
Rd 1 Gallery 2 E.PIANO RD	Ocean Pad SYN PAD	FM Sweepin... SYN PAD	Start The M... DANCE Style ARP
Wr Gallery 2 E.PIANO WR	Romance St... STRINGS Ensemble	FM Linear S... SYN PAD	Whip Motion SYN PAD
All 9 Bars! ORGAN	Texas Chick... E.GUITAR Clean	Multi Saw M... SYN COMP	Turn It On SYN COMP w/ M.SEQ

Category Search: **Freaky Dancer** (DANCE Style ARP)

Utility

Settings

- Sound
- Quick Setup
- Audio I/O
- MIDI I/O
- Advanced

▶ System

Contents

- Load
- Store / Save
- Data Utility
- Library Import

Tempo Settings

Effect Switch

Other Info

- Shift Function
- Legal Notices

- Category Search display

- Normal

Performance Category Search

Bank/Favorite: All Attribute: All

All	Piano	Keyboard	Organ	Guitar	Bass	Strings	Brass	Woodwind	No Assign
Sub	Syn Lead	Pad/Choir	Syn Comp	Chromatic Perc	Drum/Perc	Sound FX	Musical FX	Ethnic	Init
All	Analog	Digital	Hip Hop	Dance	Rock/Pop	R&B/Hip Hop	Electronic	Jazz/World	No Assign

Search Results:

Catatonix	Elektronik Chat	Freaky Dancer	Flying Dub
Illuminator	WaveRunner MW DA	SuperGlider MW DA	Reflection Twinkle
Synth Noise Vocoder	Huge Lead	Bleep Lead AF2	Detuned Vintage
Space Lead	Dual Square Lead	Vintage Sync	Dirty Hook

Sort: Audition, Default, Name, Date Favorite: Set Page: ^, v

- Large

Performance Category Search

Bank/Favorite: All Attribute: All

All	Piano	Keys	Organ	Gtr	Bass	Str	Brass	WW	---
Sub	SynLd	Pad	SynCp	CPerc	Dr/Pc	S.FX	M.FX	Ethnc	Init
All	Analg	Digtl	H Hop	Dance	Rock	R&B	Elect	Jz/Wd	---

Search Results:

Catatonix	Elektronik Chat	Freaky Dancer	Flying Dub
Illuminator	WaveRunner MW ...	SuperGlider MW ...	Reflection Twink...
Synth Noise Voco...	Huge Lead	Bleep Lead AF2	Detuned Vintage...
Space Lead	Dual Square Lea...	Vintage Sync	Dirty Hook

Sort: Audition, Default, Name, Date Favorite: Set Page: ^, v

Contents

Load

From the Load display you can load files and data.

Operation [UTILITY] → [Contents] → [Load]

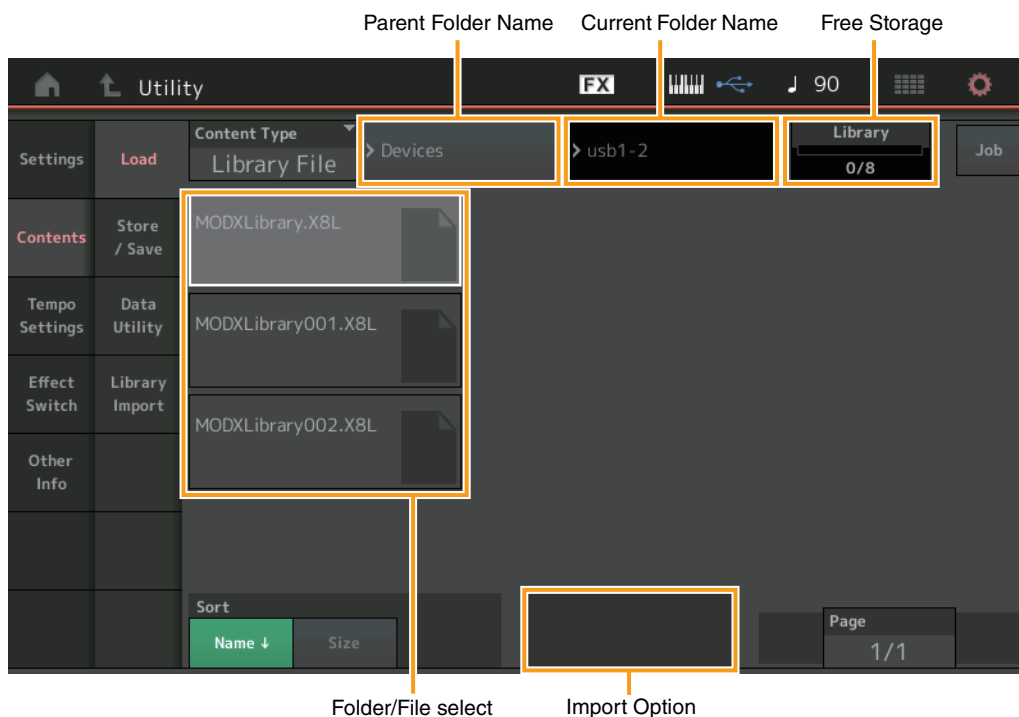

Content Type

Among the various types of data saved in a single file on a USB flash drive or this instrument, you can load all of them to this synthesizer at once or only a specific, desired type of data. This parameter determines which specific type of data will be loaded from a single file. The editable parameters differ depending on how you arrive at this display.

Settings: The file types which can be loaded as follows.

File Types	Device Type	Extension	Description
User File	File	.X8U .X7U	Files of the "User File" type saved to USB flash drive can be loaded and restored to the dedicated area in the User Memory of the instrument (page 23). User File Type data is as follows. <ul style="list-style-type: none"> • Performance • Arpeggio • Motion Sequence • Curve • Live Set (all User Banks; User 1–8) • Micro Tuning • Waveform • Utility settings • Quick Setup • Audition
Library File	File	.X8L .X7L	Files of the "Library File" type saved to USB flash drive can be loaded and restored to the dedicated area in the User Memory of the instrument (page 23). Library File Type data is as follows. <ul style="list-style-type: none"> • Performance • Arpeggio • Motion Sequence • Curve • Live Set (only one Bank; contents of User 1 Bank when saved) • Micro Tuning • Waveform • Audition

Utility

Settings

Sound

Quick Setup

Audio I/O

MIDI I/O

Advanced

System

Contents

Load

Store / Save

Data Utility

Library Import

Tempo Settings

Effect Switch

Other Info

Shift Function

Legal Notices

File Types	Device Type	Extension	Description
Backup File	File	.X8A	Data that is saved to USB flash drive as a backup file can be loaded to the User Memory again. A backup file includes all User data, Library data, and Song data. NOTE .X7A format (MONTAGE backup files) is not supported.
Song&Perf	Internal data		A specified Song in a file that is saved to the dedicated area in the User Memory as a "Song" type can be individually selected and loaded (played back) to the instrument. Both of MIDI sequence and Performance data can be loaded.
Song	Internal data		A specified Song in a file that is saved to the dedicated area in the User Memory as a "Song" type can be individually selected and loaded (played back) to the instrument. Only MIDI sequence data can be loaded.
.mid File	File	.MID	Standard MIDI File (SMF in format 0, 1) data that is saved to USB flash drive can be loaded and played back.
.wav File	File	.WAV	Audio data (Wave File) that is saved to USB flash drive can be loaded and played back.
Audio File*	File	.WAV .AIF	Audio data (Wave File and AIFF File) that is saved to USB flash drive can be loaded and as "Waveform." Example: [PERFORMANCE (HOME)] → [EDIT] → Part selection → Element selection → [Osc/Tune] → "New Waveform"
Motion Seq*	Internal data		A specified Sequence data in a file that is saved to the dedicated area in the User Memory as an "Motion Seq" type can be individually selected and loaded to the instrument. Example: [PERFORMANCE (HOME)] → [EDIT] → Part selection → Element/Operator [Common] → [Motion Seq] → [Lane] → "Load Sequence"

NOTE Files with an asterisk (*) are not displayed when you call up this display from the Utility display.

Parent Folder Name

Current Folder Name

Indicates the Parent Folder name and the current selected Folder Name. Once you touch the Parent Folder Name, the Folder becomes the currently selected folder.

Free Storage

Indicates the free space and the full space of the selected storage area.

This parameter differs depending on the Content Type.

Folder/File Select

Indicates Folders/Files in the selected Folder.

Sort (Sort Order)

Determines the Sort Order of the Files in "File Select."

Settings: Name, Size, Date, Number

Name: Sorts by name. When the lower arrow is displayed, the List is arranged in ascending order (A to Z). When the upper arrow is displayed, the List is arranged in descending order.

Size: Sorts in order of data size. When the lower arrow is displayed, the List is arranged in ascending order (small to big.) When the upper arrow is displayed, the List is arranged in opposite order. This is not available for "Motion Seq," "Song," and "Song&Perf" type Files.

Date: Sorts in order of storing. When the lower arrow is displayed, the List is arranged in descending order (newer to older). When the upper arrow is displayed, the List is arranged in ascending order. This is available only for "Motion Seq," "Song," and "Song&Perf" type Files.

Number: Sorts in order of Content Number. This is available only for "Song" and "Song&Perf" type Files.

Import Option

With the MOTIF XF, MOTIF, XS, or MOXF files, you can set the file to be loaded as Performance or Voice.

Settings: Voice, Perf

Page (Page Select)

When Files in "File Select" are displayed in multiple pages, you will need to use this button to scroll through the pages.

Utility

Settings

Sound

Quick Setup

Audio I/O

MIDI I/O

Advanced

System

Contents

▶ Load

Store / Save

Data Utility

Library Import

Tempo Settings

Effect Switch

Other Info

Shift Function

Legal Notices

Job (Job Switch)

Determines whether the Job function is active (On) or not (Off.) When this parameter is turned on, touching the File/Folder/Content in “File Select” calls up the menu to select “Rename” or “Delete.” Touching the currently connected USB device calls up the menu to select “Format.”

Settings: Off, On

Compatible with the MONTAGE6/MONTAGE7/MONTAGE8 data

The following data can be loaded to MODX6/MODX7/MODX8 among all MONTAGE6/MONTAGE7/MONTAGE8 data. Note that .X7U files are loaded only as “User Files” and that .7L files are loaded only as “Library Files.”

Also you can switch the Content Type between User file and Library file.

NOTE The .X7A format (MONTAGE backup files) is not supported.

File Type on MONTAGE	Extension on MONTAGE	Contents
User File	.X7U	User File
Library File	.X7L	Library File

Compatible with the MOTIF XF6/MOTIF XF7/MOTIF XF8 data

The following data can be loaded to MODX6/MODX7/MODX8 among all MOTIF XF6/MOTIF XF7/MOTIF XF8 data. Please note that the data is loaded as “User File” or “Library File.”

Also you can switch the Content Type between User file and Library file.

File Type on MOTIF XF	Extension on MOTIF XF	Contents
All	.X3A	User Voice, User Arpeggio, User Waveform
AllVoice (All Voice)	.X3V	User Voice, User Waveform
AllArp (All Arpeggio)	.X3G	User Arpeggio
AllWaveform (All Waveform)	.X3W	User Waveform

Compatible with the MOTIF XS6/MOTIF XS7/MOTIF XS8 data

The following data can be loaded to MODX6/MODX7/MODX8 among all MOTIF XS6/MOTIF XS7/MOTIF XS8 data. Please note that the data is loaded as “User File” or “Library File.”

Also you can switch the Content Type between User file and Library file.

File Type on MOTIF XS	Extension on MOTIF XS	Contents
All	.X0A	User Voice, User Arpeggio, User Waveform
AllVoice (All Voice)	.X0V	User Voice, User Waveform
AllArp (All Arpeggio)	.X0G	User Arpeggio
AllWaveform (All Waveform)	.X0W	User Waveform0

Compatible with the MOXF6/MOXF8 data

The following data can be loaded to MODX6/MODX7/MODX8 among all MOXF6/MOXF8 data. Please note that the data is loaded as “User File” or “Library File.”

Also you can switch the Content Type between User file and Library file.

File Type on MOXF	Extension on MOXF	Contents
All	.X6A	User Voice, User Arpeggio, User Waveform
AllVoice (All Voice)	.X6V	User Voice, User Waveform
AllArp (All Arpeggio)	.X6G	User Arpeggio
AllWaveform (All Waveform)	.X6W	User Waveform

Utility

Settings

Sound

Quick Setup

Audio I/O

MIDI I/O

Advanced

System

Contents

▶ Load

Store / Save

Data Utility

Library Import

Tempo Settings

Effect Switch

Other Info

Shift Function

Legal Notices

Store/Save

From the Store/Save display you can store Files and data.

Operation

Press the [STORE] button
or
[UTILITY] → [Contents] → [Store / Save]

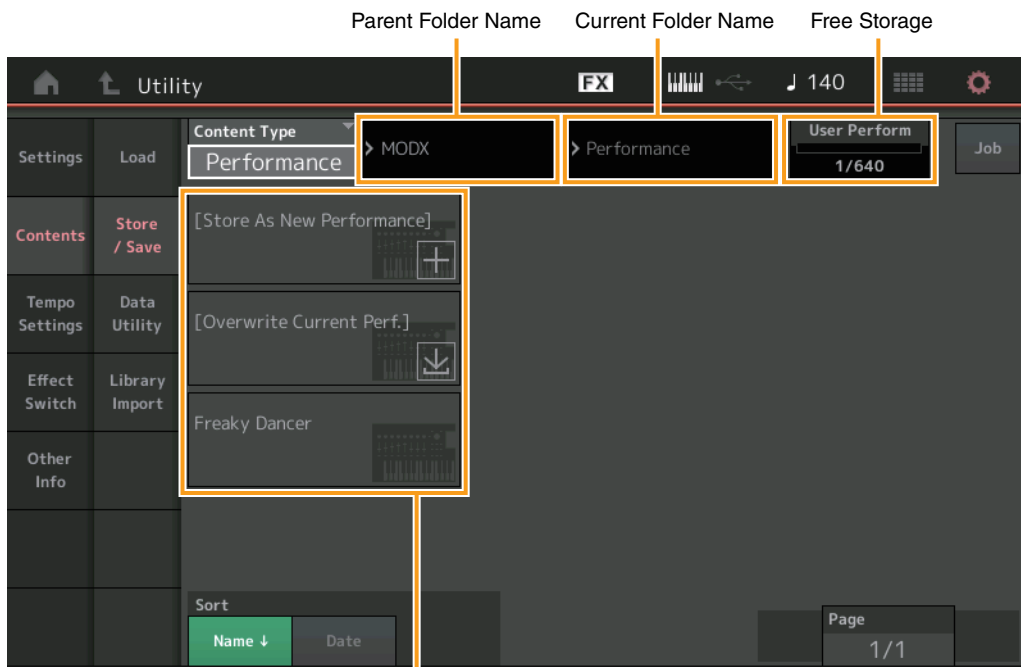

File select

Content Type

You can store all data or the specified data to the instrument or USB flash drive. This parameter determines which specific data will be stored/saved.

The editable setting value differs depending on how you arrive at this display.

Settings: The Content Types which can be stored/saved are as follows.

File Types	Device Type	Extension	Description
Performance	Internal data		Data can be stored to the dedicated area in the User Memory as a "Performance" (page 23).
User File	File	.X8U	Data that is stored to the dedicated area in the User Memory can be saved to USB flash drive. Data saved as "User File" is as follows. <ul style="list-style-type: none"> • Performance • Arpeggio • Motion Sequence • Curve • Live Set (all User Banks; User 1–8) • Micro Tuning • Waveform • Utility Settings • Quick Setup • Audition
Library File	File	.X8L	Data that is stored to the dedicated area in the User Memory can be saved to USB flash drive. Data saved as "Library File" is as follows. <ul style="list-style-type: none"> • Performance • Arpeggio • Motion Sequence • Curve • Live Set (User1 Bank only) • Micro Tuning • Waveform • Audition

Utility

Settings

Sound

Quick Setup

Audio I/O

MIDI I/O

Advanced

System

Contents

Load

▶ Store / Save

Data Utility

Library Import

Tempo Settings

Effect Switch

Other Info

Shift Function

Legal Notices

File Types	Device Type	Extension	Description
Backup File	File	.X8A	Data that is saved to USB flash drive as a backup file can be loaded to the User Memory again. A backup file includes all User data, Library data, and Song data.
.mid File	File	.MID	MIDI data that is stored to the dedicated area in the User Memory (page 23) can be saved as a Standard MIDI File (only Format 0 SMF) to USB flash drive.
Motion Seq*	Internal data		Data can be stored as "Motion Seq" to the dedicated area in the User Memory. Example: [PERFORMANCE (HOME)] → [EDIT] → Part selection → Element/Operator [Common] → [Motion Seq] → [Lane] → "Edit Sequence" to call up "Motion Sequence Edit" → "Store Sequence"

NOTE Files with an asterisk (*) are not displayed when you call up this display from the Utility display.

Parent Folder Name

Current Folder Name

Indicates the parent folder name and the current selected folder name. Once you touch the Parent Folder Name, the Folder becomes the currently selected folder.

Free Storage

Indicates the free space and the full space of the selected storage area. This parameter differs depending on the Content Type.

Folder/File Select

Indicates folders/files in the selected folder.

Sort (Sort Order)

Determines the sort order of the files in "File Select."

Settings: Name, Size, Date

Name: Sorts by name. When the lower arrow is displayed, the List is arranged in ascending order (A to Z). When the upper arrow is displayed, the list is arranged in descending order.

Size: Sorts in order of data size. When the lower arrow is displayed, the List is arranged in ascending order (small to big.) When the upper arrow is displayed, the List is arranged in opposite order. This is not available for "Performance" and "Motion Seq" type files.

Date: Sorts in order of storing. When the lower arrow is displayed, the List is arranged in descending order (newer to older). When the upper arrow is displayed, the List is arranged in ascending order. This is available only for "Performance" and "Motion Seq" type files.

Page (Page Select)

When files in "File Select" are displayed in multiple pages, you will need to use this button to scroll through the pages.

Job (Job Switch)

Determines whether the Job function is active (On) or not (Off.) When this parameter is turned on, touching the File/Folder/Content in "File Select" calls up the menu to select "Rename" or "Delete."

Touching the currently connected USB device calls up the menu to select "Format."

Also you can create a new folder when storing a file.

Settings: Off, On

Utility

Settings

Sound

Quick Setup

Audio I/O

MIDI I/O

Advanced

System

Contents

Load

▶ Store / Save

Data Utility

Library Import

Tempo Settings

Effect Switch

Other Info

Shift Function

Legal Notices

Data Utility

From the Data Utility display you can control Files and data in the User Memory. Also, you can collectively delete multiple contents such as Performances in the User Memory.

Operation [UTILITY] → [Contents] → [Data Utility]

Folder List

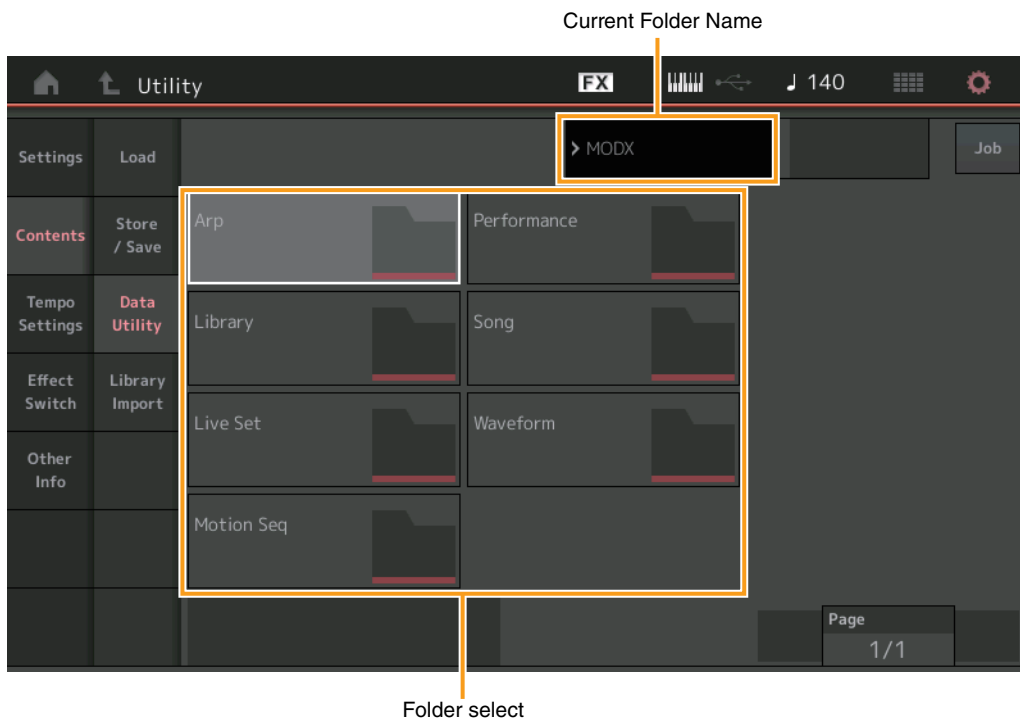

Current Folder Name

Indicates the Current Folder Name.

Job (Job Switch)

Determines whether the Job function is active (On) or not (Off). This parameter is available only for the "Waveform" folder on this display. When the parameter is turned on, touching "Waveform" folder calls up the menu to select "Optimize." When this function is active, you can select multiple contents collectively from this display.

Settings: Off, On

Folder Select

Indicates the Content Types in the User Memory as folders. Touching the Folder opens it.

- Arp (Arpeggio)
- Library
- Live Set
- Motion Seq
- Performance
- Song
- Waveform

Page (Page Select)

When folders in "Folder Select" are displayed in multiple pages, you will need to use this button to scroll through the pages.

Utility

Settings

- Sound
- Quick Setup
- Audio I/O
- MIDI I/O
- Advanced
- System

Contents

- Load
- Store / Save
- ▶ Data Utility
- Library Import

Tempo Settings

Effect Switch

Other Info

- Shift Function
- Legal Notices

■ When the selected Folder is opened

When this function is active, you can select multiple contents collectively from this display.

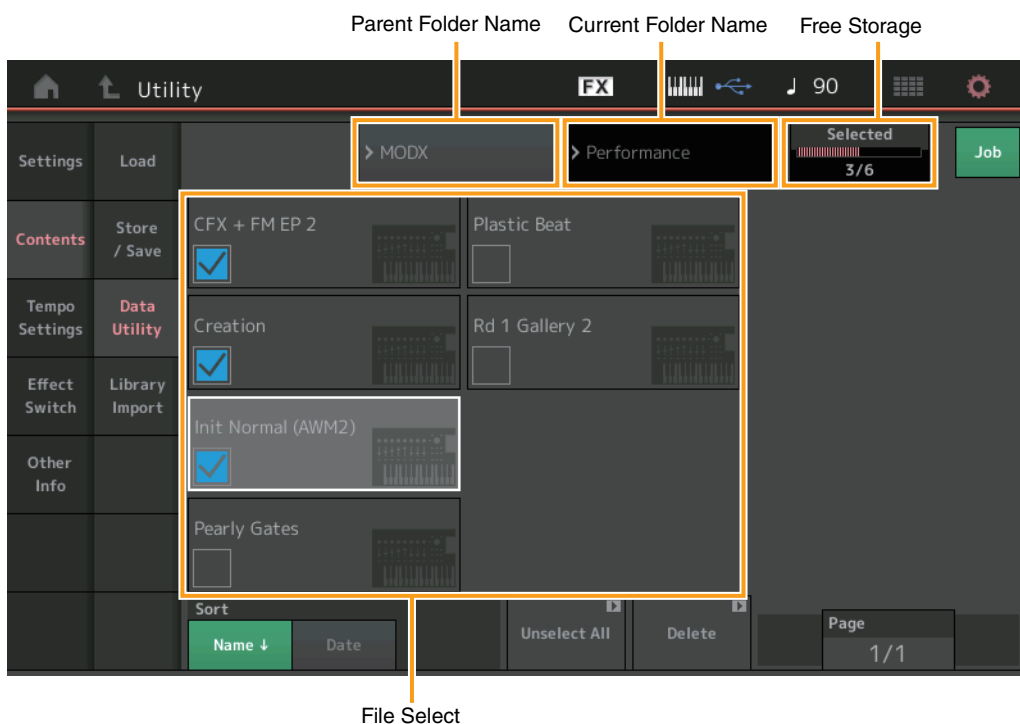

Utility

Settings

- Sound
- Quick Setup
- Audio I/O
- MIDI I/O
- Advanced
- System

Contents

- Load
- Store / Save
- ▶ Data Utility
- Library Import

Tempo Settings

Effect Switch

Other Info

- Shift Function
- Legal Notices

Parent Folder Name

Current Folder Name

Indicates the parent folder name and the current selected folder name. Touching the parent folder name returns to the folder list view.

Free Storage

Indicates the free space and the full space of the selected storage area. This parameter differs depending on the Content Type. This parameter is displayed only when “Job” is set to OFF.

File Select

Indicates Files in the selected Folder. The Job function is always available in this display. Touching the File/Content in “File Select” calls up the menu to select “Rename” or “Delete.” (“Rename” is not available for the Files in “Library” type Folder.)

Sort (Sort Order)

Determines the Sort Order of the Files in “File Select.”

Settings: Name, Size, Date, Number

Name: Sorts by name. When the lower arrow is displayed, the List is arranged in ascending order (A to Z). When the upper arrow is displayed, the List is arranged in descending order.

Size: Sorts in order of data size. When the lower arrow is displayed, the List is arranged in ascending order (small to large). When the upper arrow is displayed, the List is arranged in opposite order. This is available only for “Library” type Contents.

Date: Sorts in order of storing. When the lower arrow is displayed, the List is arranged in descending order (newer to older). When the upper arrow is displayed, the List is arranged in ascending order. This is not available for “Arp” and “Library” type Contents.

Number: Sorts in order of Content Number. This is available only for “Arp,” “Song,” and “Waveform” type Contents.

Select All

Selects all contents in the folder. This button is displayed only when no content is selected.

Unselect All

Unselects all contents in the folder. This button is displayed only when any of contents is selected.

Delete

Deletes the selected content(s). This button is displayed only when any of contents is selected.

Page (Page Select)

When Files in “File Select” are displayed in multiple pages, you will need to use this button to scroll through the pages.

Library Import

You can select a desired Performance in the Library file which is loaded to the User Memory and copy the Performance to the User Bank.

Operation [UTILITY] → [Contents] → [Library Import]

Library Folder List

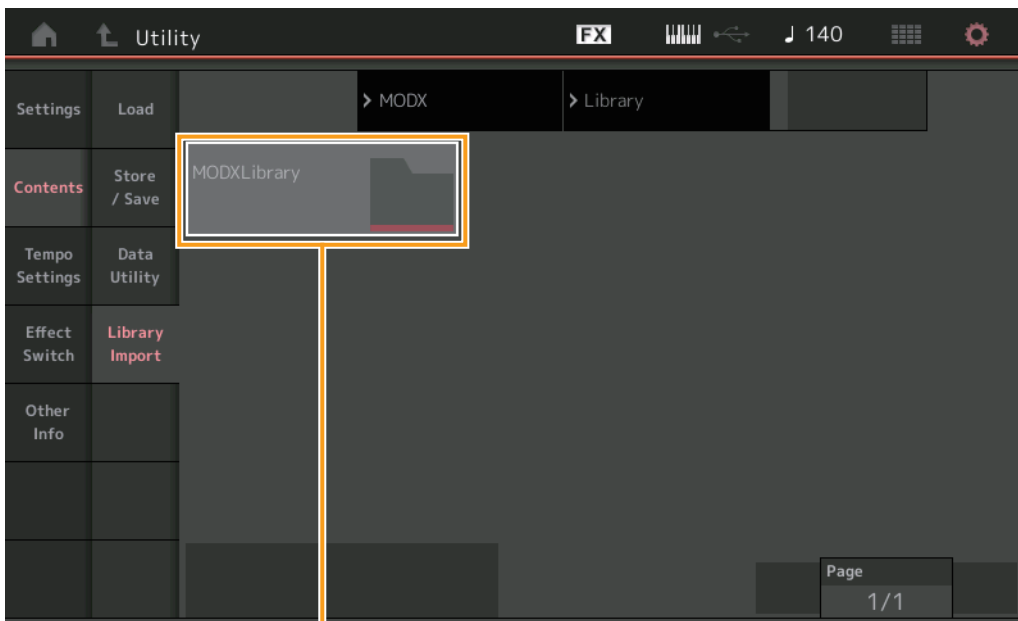

Library Folder Select

Library Folder Select

Indicates the Libraries as folders. Touching the Folder opens it. These folders are displayed only when Library files are loaded in the Load display.

Utility

Settings

- Sound
- Quick Setup
- Audio I/O
- MIDI I/O
- Advanced
- System

Contents

- Load
- Store / Save
- ▶ Data Utility
- ▶ Library Import

Tempo Settings

Effect Switch

Other Info

- Shift Function
- Legal Notices

■ When the selected Library Folder is opened

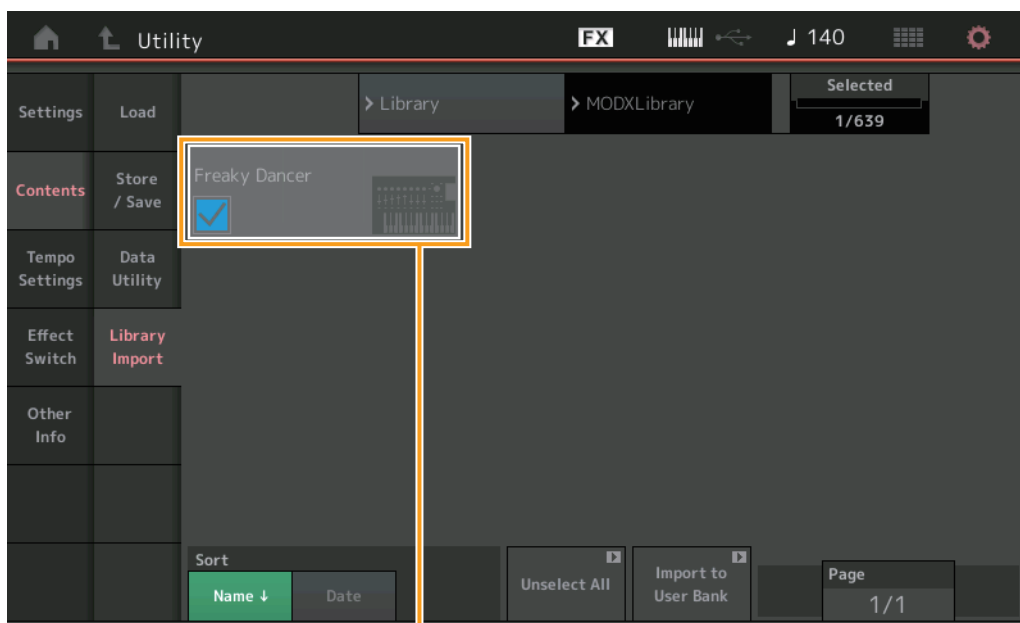

Performance Select

Performance Select

Indicates the Performances in the selected Library. Touching the name switches between being selected or unselected.

Select All

Selects all Performances in the selected Library folder. This button is displayed only when no Performance is selected.

Unselect All

Unselects all Performances in the Library folder. This button is displayed only when any of Performances is selected.

Import to User Bank

Copies the selected Performance in the User Bank. User Waveforms and User Arpeggio which are used in the selected Performance are copied to the User Bank as well. This button is displayed only when any of the Performances is selected.

Utility

Settings

- Sound
- Quick Setup
- Audio I/O
- MIDI I/O
- Advanced
- System

Contents

- Load
- Store / Save
- Data Utility
- ▶ Library Import

Tempo Settings

Effect Switch

Other Info

- Shift Function
- Legal Notices

Tempo Settings

From the Tempo Settings display you can set parameters related to Tempo and Synchronization.

Operation

[UTILITY] → [Tempo Settings]
or
[SHIFT] + [ENTER]
or
Touch the TEMPO SETTING icon

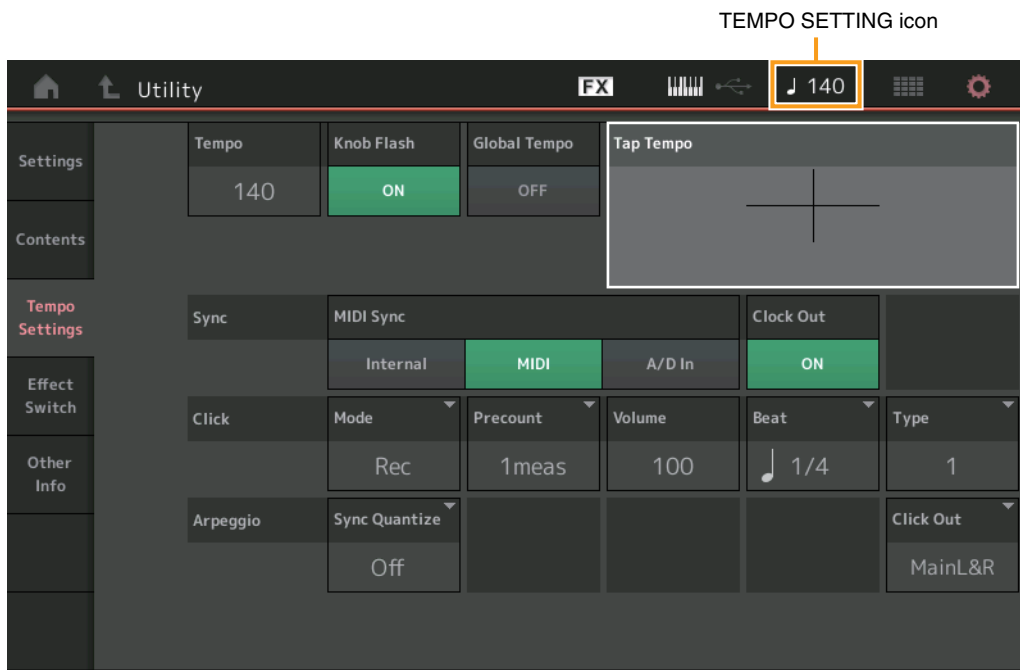

Tempo

Determines the Performance tempo. This parameter is not available when the “MIDI Sync” is set to “MIDI” or “A/D In” and the instrument is synchronized to an external device (“EX. Tempo” is displayed instead of the setting value.)

Settings: 5–300

Knob Flash (Super Knob LED Switch)

Determines whether the flashing of the Super Knob is turned on or off.

Settings: Off, On

Global Tempo (Global Tempo Switch)

When this switch is set to OFF, the tempo setting changes when a different Performance is selected. When this switch is set to ON, the current tempo is used for all Performances.

Settings: Off, On

Tap Tempo

Allows you to tap the desired tempo by touching this parameter or by moving the cursor to this parameter and pressing (tapping) the [ENTER] button on the panel.

This parameter is not displayed when the “MIDI Sync” is set to “MIDI” and the instrument is synchronized to an external device.

NOTE When “MIDI Sync” is set to “A/D In,” the tempo search starts by touching this parameter.

Utility

Settings

- Sound
- Quick Setup
- Audio I/O
- MIDI I/O
- Advanced
- System

Contents

- Load
- Store / Save
- Data Utility
- Library Import

▶ Tempo Settings

Effect Switch

Other Info

- Shift Function
- Legal Notices

MIDI Sync

Determines parameters related to MIDI clock and synchronization.

Determines whether Arpeggio/Motion Sequencer/Song playback will be synchronized to the instrument's internal clock, an external MIDI clock, or the Audio signal input from the A/D INPUT [L/MONO]/[R] jacks.

Settings: Internal, MIDI, A/D In

Internal: Synchronization to internal clock. You can use this setting when this tone generator is to be used alone or as the master clock source for other equipment.

MIDI: Synchronization to a MIDI clock received from an external MIDI instrument via MIDI. Use this setting when the external sequencer is to be used as master.

A/D In: Synchronization to the tempo of the Audio signal received via the A/D INPUT [L/MONO]/[R] jacks.

Clock Out

Determines whether MIDI clock messages will be transmitted or not.

Settings: Off, On

Mode (Click Mode)

Determines the click sound (metronome) that is used during recording or playback.

Settings: Off, Rec, Rec/Play, Always

Off: The click will not sound.

Rec: The click will sound during Song recording only.

Rec/Play: The click will sound during Song recording and playback.

Always: The click will always sound.

Precount (Click Pre-count)

Determines the number of count-in measures provided before recording actually starts after pressing the [▶] (Play) button while the Song recording.

Settings: Off (Recording starts as soon as the [▶] (Play) button is pressed), 1meas–8meas

NOTE Since the click sound is created with the internal tone generator, using click playback affects the overall polyphony of the instrument.

Volume (Click Volume)

Determines the click sound volume.

Settings: 0–127

Beat (Click Beat)

Determines which beats the metronome click will sound.

Settings: 1/16 (16th notes), 1/8 (8th notes), 1/4 (quarter notes), 1/2 (half notes), Whole (whole notes)

Type (Click Type)

Determines the click sound type.

Settings: 1–10

Sync Quantize (Sync Quantize Value)

Determines the actual timing at which the next Arpeggio playback starts when you trigger it while the Arpeggio of multiple Parts is played back. When set to “off,” the next Arpeggio starts as soon as you trigger it. The displayed number indicates the resolution in clocks.

Settings: Off, 60 (32nd note), 80 (16th note triplet), 120 (16th note), 160 (8th note triplet), 240 (8th note), 320 (1/4 note triplet), 480 (1/4 note)

Click Out (Click Output Select)

Determines the specified output for the “Click.”

Settings: MainL&R, USB1&2...USB7&8, USB1...USB8

MainL&R: Outputs in stereo (two channels) to the OUTPUT [L/MONO]/[R] jacks.

USB1&2...USB7&8: Outputs in stereo (Channels 1&2–7&8) to the [USB TO HOST] terminal.

USB1...USB8: Outputs in mono (Channels 1–8) to the [USB TO HOST] terminal.

Utility

Settings

Sound

Quick Setup

Audio I/O

MIDI I/O

Advanced

System

Contents

Load

Store / Save

Data Utility

Library Import

▶ Tempo Settings

Effect Switch

Other Info

Shift Function

Legal Notices

Effect Switch

From the Effect Switch display you can make Effect Bypass settings. None of the settings made on this display will be stored. When the instrument is restarted, the parameter values are also initialized.

Operation

[UTILITY] → [Effect Switch]
or
Touch the EFFECT icon

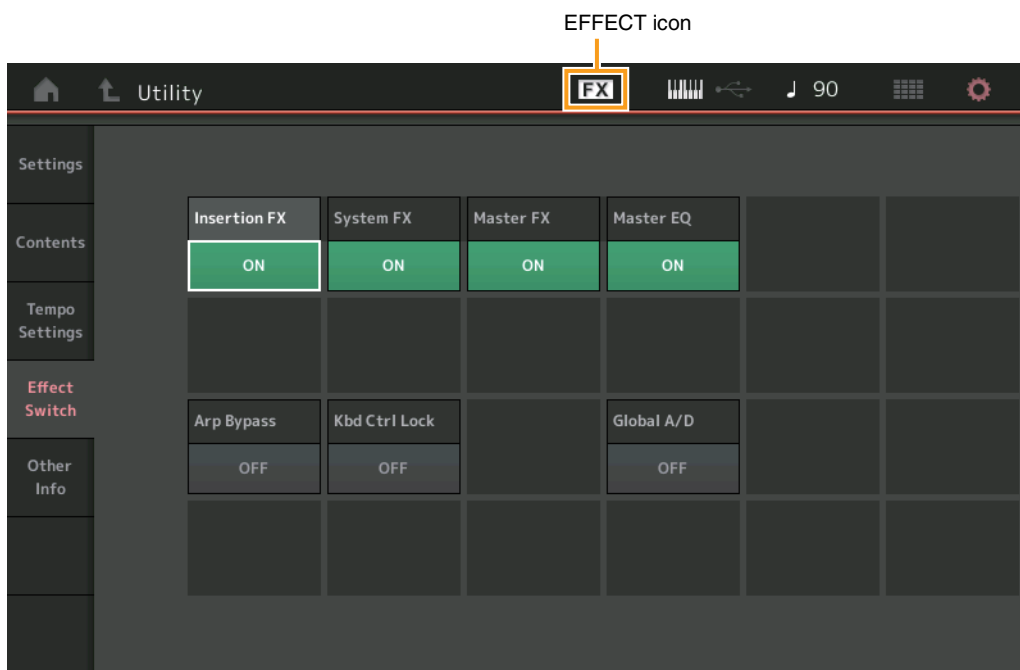

Insertion FX (Insertion Effect Switch)

Determines whether the Insertion Effect is active or not.

Settings: Off, On

System FX (System Effect Switch)

Determines whether the System Effect is active or not.

Settings: Off, On

Master FX (Master Effect Switch)

Determines whether the Master Effect is active or not. This parameter is automatically switched off when Global A/D is ON, and switched on when Global A/D is OFF. Set this switch manually when needed.

Settings: Off, On

Master EQ Switch

Determines whether the Master EQ is active or not. This parameter is automatically switched OFF when Global A/D is set to ON, and switched ON when Global A/D is set to OFF. Set this switch manually when needed.

The Master EQ Switch settings are not stored.

Settings: Off, On

Arp Bypass (Arpeggio Bypass Switch)

Determines whether the Arpeggio Bypass is active or not. When this is set to on, all Arpeggiator operations are disabled.

Settings: Off, On

NOTE Arpeggio Bypass can also be turned on/off by simultaneously holding down the [SHIFT] button and using the [ARP ON/OFF] button. The [ARP ON/OFF] button flashes when Arpeggio Bypass is turned on.

NOTE When the Part Arpeggio Switch setting is changed, Arpeggio Bypass is automatically turned off even if it has been set to on.

NOTE You can edit arpeggios in Song data generated by the arpeggiator with using DAW software. By turning Arpeggio Bypass on, you can prevent Song data edited on the DAW software from being affected again by the arpeggiator when routed back to the MODX.

Utility

Settings

Sound

Quick Setup

Audio I/O

MIDI I/O

Advanced

System

Contents

Load

Store / Save

Data Utility

Library Import

Tempo Settings

Effect Switch

Other Info

Shift Function

Legal Notices

Kbd Ctrl Lock (Keyboard Control Lock)

Determines whether Keyboard Control Lock is active or not. When this is set to on, the Keyboard Control is turned on only for Part 1 and off for the other Parts.

When this is set to off, Keyboard Control settings for all Parts are returned to the original status.

Settings: Off, On

NOTE When you use the MODX as a 16-part multi-timbral sound module with DAW software, the Keyboard Control Lock function is useful for creating or editing MIDI tracks one by one.

Global A/D

Determines whether the volume for the A/D Part changes when you switch the Performances.

When this parameter is ON, the volume for the A/D Part stays the same, and other parameters related to the A/D Part do not change. When set to OFF, the volume changes according to the volume set in each Performance, and other parameters related to the A/D Part change accordingly.

The Global A/D settings are not stored.

Settings: Off, On

Utility

Settings

Sound

Quick Setup

Audio I/O

MIDI I/O

Advanced

System

Contents

Load

Store / Save

Data Utility

Library Import

Tempo Settings

▶ Effect Switch

Other Info

Shift Function

Legal Notices

Other Info

Shows other information.

Shift Function

Shows the Shift Function List.

Legal Notices

Shows legal notices such as the GNU GENERAL PUBLIC LICENSE.

Utility

Settings

- Sound
- Quick Setup
- Audio I/O
- MIDI I/O
- Advanced
- System

Contents

- Load
- Store / Save
- Data Utility
- Library Import

Tempo Settings

Effect Switch

▶ Other Info

- ▶ Shift Function

- ▶ Legal Notices

Live Set

Live Set is a list in which Performances can be freely arranged. Up to 16 Performances can be selected from the Preset Live Sets and arranged over a single page—making it easy to call up and play your favorite Performances. For basic instructions on Live Set, see the Owner's Manual.

Live Set

▶ Live Set

Edit

Register

Live Set

From the Live Set display you can call up the registered Performances.

Operation

Press the [LIVE SET] button,
or
Touch the LIVE SET icon

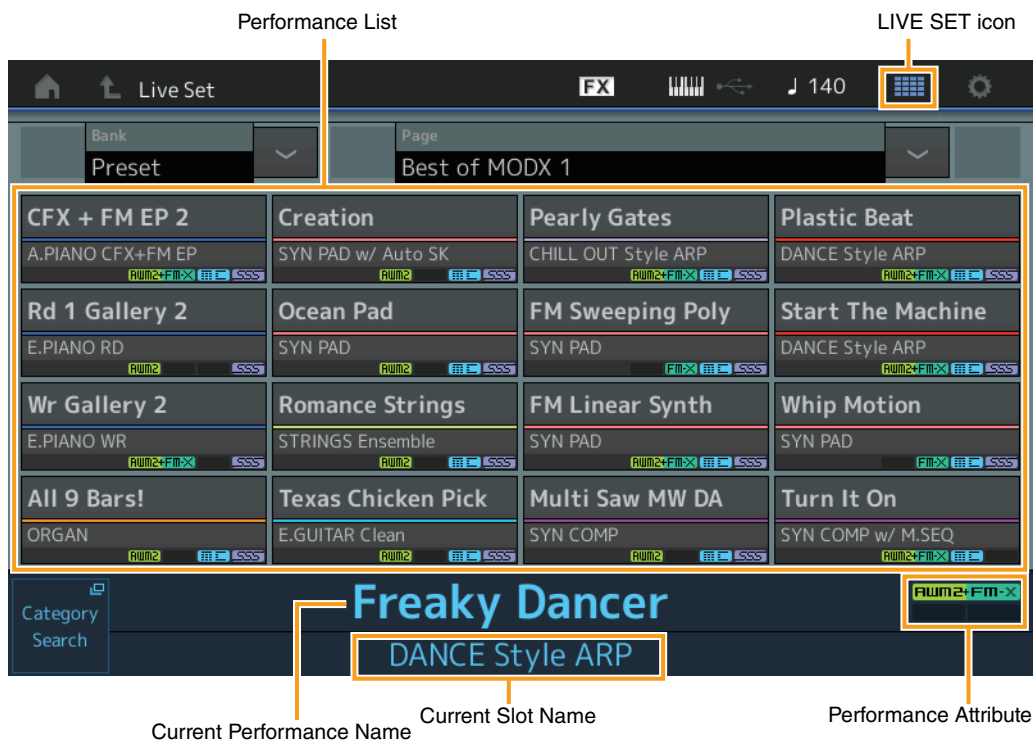

Bank (Live Set Bank Select)

Determines the Live Set Bank.

Settings: Preset, User 1–8 (default), Library Name (when the Library file is read)

Page (Live Set Page Select)

Determines the Live Set Page.

Settings: Live Set page 1–16 (default)

Performance List

Indicates the Performances registered in the selected Live Set.

Category Search

Calls up the Performance Category Search display ([page 176](#)).

Current Performance Name

Indicates the selected Performance Name registered in the selected slot.

Current Slot Name

Indicates the selected Slot Name.

Performance Attribute

Indicates the Performance Attribute registered in the selected Slot.

Live Set Edit (Edit)

From the Live Set Edit display you can edit the Live Sets (User Bank only).

Operation [LIVE SET] → User Bank selection → [EDIT]

■ When the Slot to which a Performance has been registered is selected

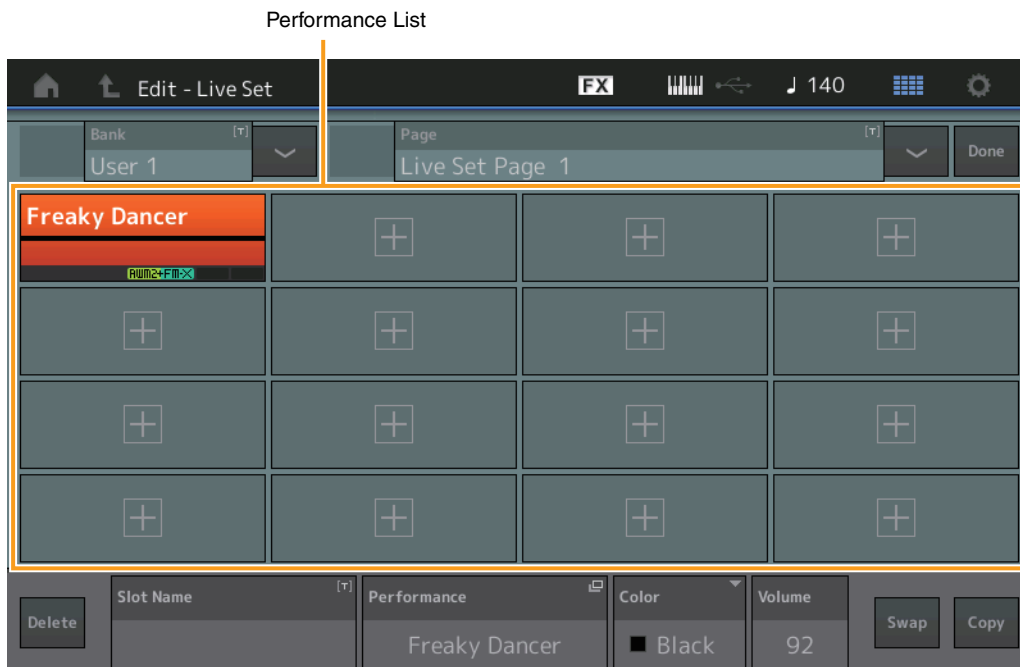

Bank (Live Set Bank Name)

Enters the desired name for the selected Live Set Bank. The names can contain up to 20 characters. Touching the parameter calls up the input character display.

Page (Live Set Page Name)

Enters the desired name of the selected Live Set Page. The names can contain up to 20 characters. Touching the parameter calls up the input character display.

Done

Touching this parameter finishes the Live Set Editing and returns to the Live Set display.

Performance List

Indicates the Performances registered in the selected Live Set.

Delete

Deletes the Performance from the selected Slot.

Slot Name

Enters the desired name of the selected Slot. The names can contain up to 20 characters. Touching the parameter calls up the input character display.

Performance (Performance Name)

Indicates the Performance Name in the selected Slot.

Color

Determines the Color of the selected Slot.

Settings: Black, Red, Yellow, Green, Blue, Azure, Pink, Orange, Purple, Sakura, Cream, Lime, Aqua, Beige, Mint, Lilac

Volume

Determines the volume of the Performance in the selected Slot.

Live Set

Live Set

▶ Edit

Register

Swap (Swap Switch)

Determines whether the Swap function is turned on or off. You can switch settings between Slots. For instructions on the Swap function, see the Owner's Manual.

Settings: Off, On

Copy (Copy Switch)

Determines whether the Copy function is turned on or off. You can copy the setting to another Slot.

Settings: Off, On

Live Set

Live Set

▶ Edit

Register

■ When an empty Slot is selected

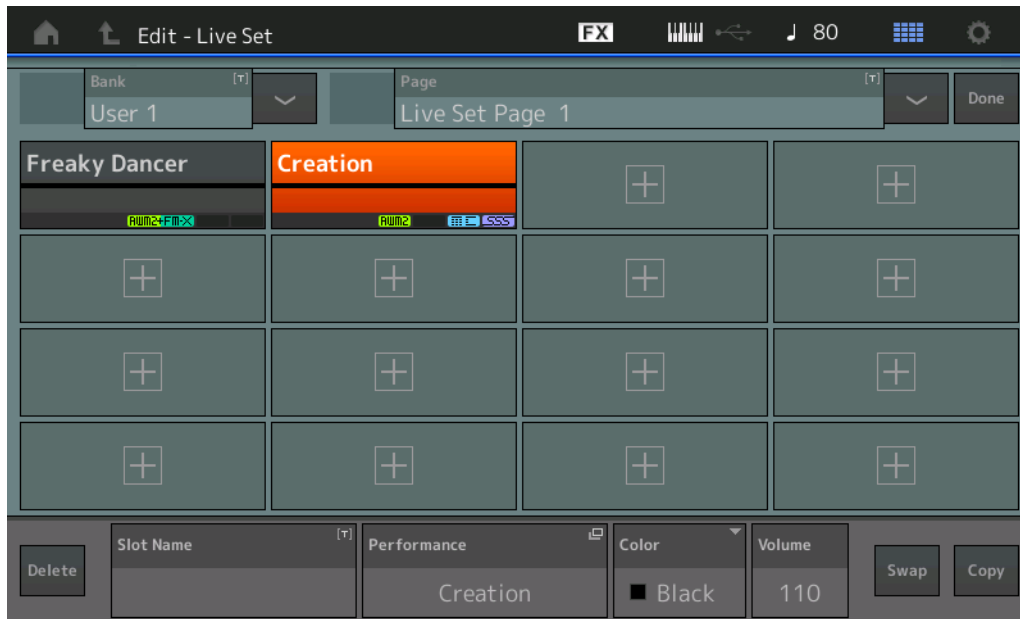

■ Copying or Exchanging Live Sets

You can copy (or exchange) between Live Sets on a Bank or page basis.

NOTE Page copy (or exchange) between different Banks cannot be executed.

Operation [LIVE SET] → User Bank selection → [EDIT] → Select Bank/Page to be copied → [SHIFT] + [EDIT]

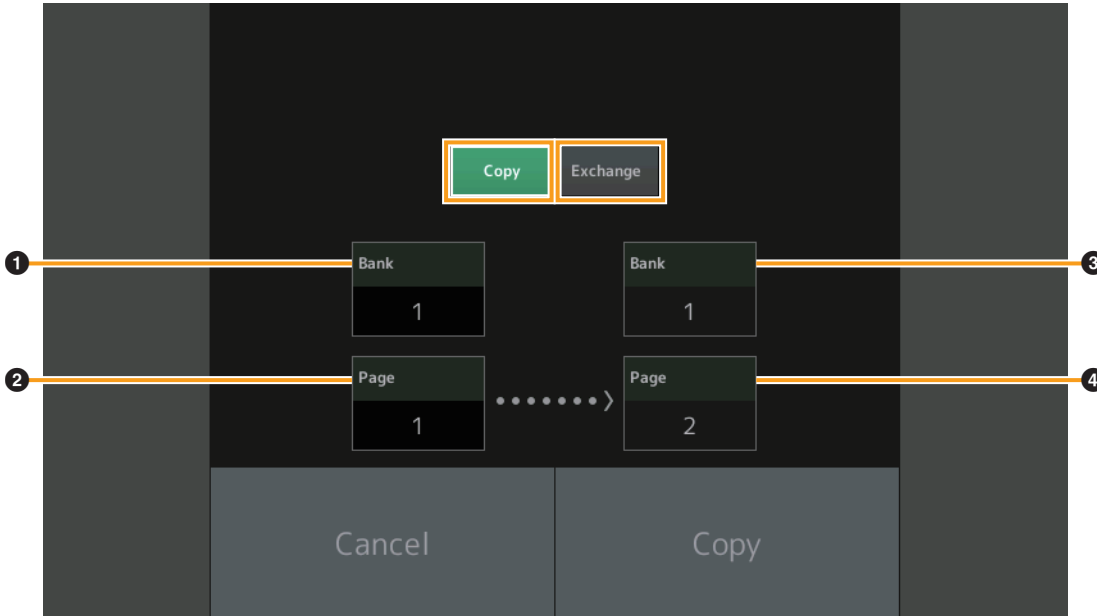

Copy

Touching this button activates the Bank/Page Copy function.

Exchange

Touching this button activates the Bank/Page Exchange function.

❶ Bank to be copied (or exchanged)

NOTE The currently selected Part is set automatically and this setting cannot be changed.

❷ Page to be copied (or exchanged)

❸ Copy (or exchange) destination Bank

❹ Copy (or exchange) destination Page

Live Set

Live Set

▶ Edit

Register

Live Set Register (Register)

From the Live Set Register display you can register Performances to the Live Set. For basic instructions on Live Set Registering, see the Owner's Manual.

Operation [SHIFT] + [LIVE SET] (from any operation displays, other than Live Set)

Live Set

Live Set

Edit

▶ Register

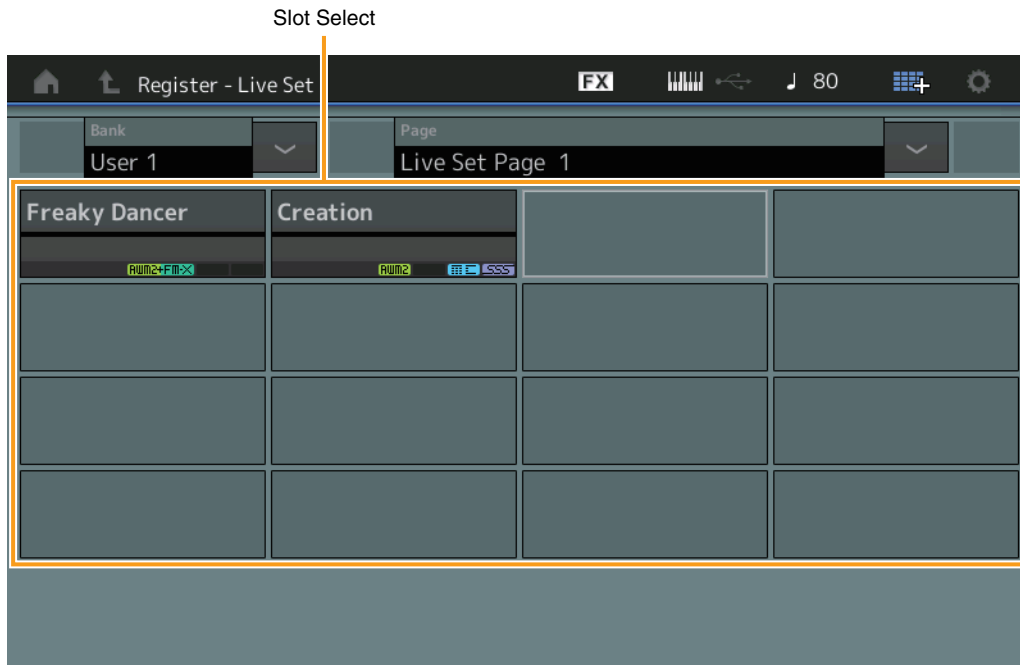

Bank (Live Set Bank Select)

Determines the Live Set Bank for registering Performances. Preset Bank and Library Bank cannot be selected for this parameter.

Settings: User 1–8 (default)

Page (Live Set Page Select)

Determines the Live Set Page for registering Performances.

Settings: Live Set Page 1–16 (default)

Slot Select

Determines the Slot for registering Performance. When the Slot containing the Performance is selected and press the [ENTER] button (or touch the Slot again on the display), the Performance in the slot is replaced with the currently selected Performance.

Settings: Slot 1–16

Connecting an iPhone or iPad

iPhone/iPad connection

NOTE In order to eliminate the risk of noise from other communication when using this instrument with an iPad or iPhone app, be sure to turn on Airplane Mode and then turn on Wi-Fi.

NOTICE

Be sure to place your iPad or iPhone on a stable surface to prevent it from falling over and being damaged.

Apps compatible with the MODX provide many more convenient, enjoyable ways to use this musical instrument.

For details on how to connect the devices, refer to the “iPhone/iPad Connection Manual,” which is available from the Yamaha web site.

NOTE For audio signal transfer, refer to the connection using Lightning to USB Camera Adapter.

Details of compatible smart devices and apps can be found on the following page from the Yamaha web site.

<http://www.yamaha.com/kbdapps/>