

# YAMAHA TC800GL

Stereo cassette deck with radical new Mario Bellini design

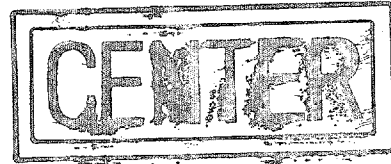

- Ultra-low wow & flutter
- Pitch control
- Memory rewind
- Automatic tape bias & equalization switchover
- Dual level meters and peak level indicator lamps
- IC type Dolby circuit
- Three-way power source
- Limiter circuit
- Timer-controlled recording start system
- Auto shutoff
- OTL IC headphone amp
- Mic mixing—dual mic jacks

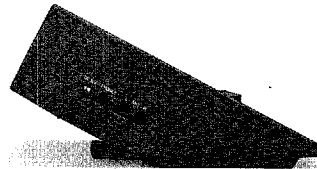
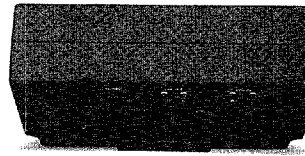
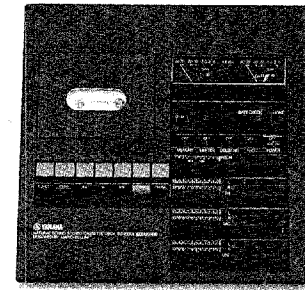

*Owner's Manual*

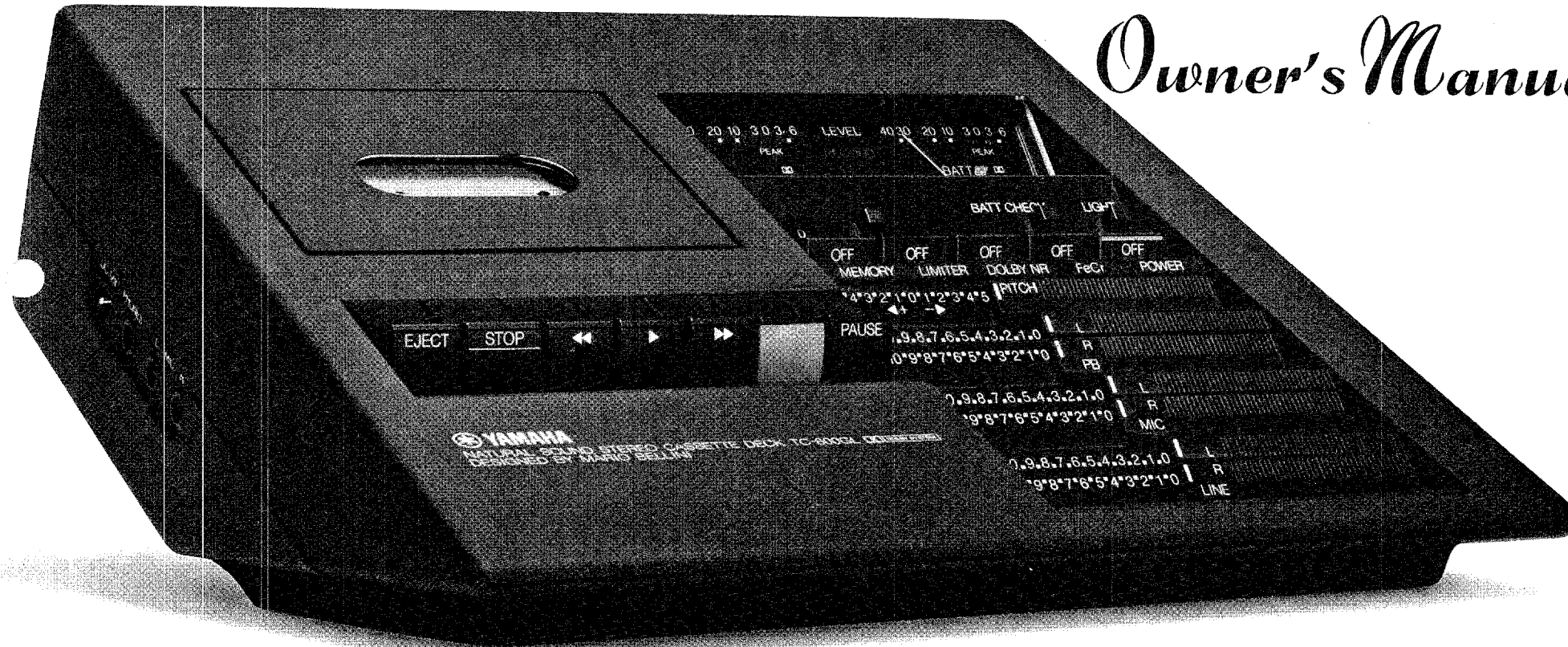

# CONTENTS

## ●TC-800GL

READ THIS FIRST.....	3
SETTING UP THE TC-800GL.....	3
PARTS & CONTROLS.....	4
PLAYBACK.....	6
RECORDING.....	8
BATTERY INSERTION.....	10
CLEANING THE HEAD.....	10
SPECIFICATIONS.....	11

## ●YOUR MINI CASSETTE GUIDE

CASSETTE RECORDING.....	13
THE DOLBY SYSTEM.....	14
DOLBY RECORDING & PLAYBACK POINTS.....	14
YOU CAN BE A MIXER!.....	15
OUT & AROUND WITH YOUR DECK.....	18
FM RECORDING.....	19
THE TAPE MECHANISM.....	20
CASSETTE TAPE & SELECTORS.....	21
MIXING.....	22
DUBBING.....	22
CASSETTE DECK CARE.....	23
TROUBLESHOOTING.....	24
CASSETTE QUESTIONS & ANSWERS.....	25

## READ THIS FIRST

In order to derive the most in listening pleasure and durability from your TC-800GL, pay careful attention to the following points, in order to avoid unnecessary damage.

- Avoid exposing the unit to direct sunlight, heat or dust.
- Avoid an especially cold location.
- Do not place the unit near sources of magnetism, such as a television set or an appliance which incorporates a motor or transformer, etc.
- Avoid a location with noticeable vibration.
- If you hear a click sound when the power switch is turned on, this is perfectly normal and does not indicate a defect in the unit.

To protect the mechanism (and your tapes) against dust, store each cassette in its own case. Tapes should be fully wound in the opposite direction at least once every three months.

## SETTING UP THE TC-800GL

To use the unit on a table-top, etc., first swing out the support flap on the rear side, then rest the recorder tilting up so the support is flat on the table-top.

This unique design was especially created for Yamaha by the world-famous Mario Bellini, and it makes the TC-800GL a unique addition to any decor.

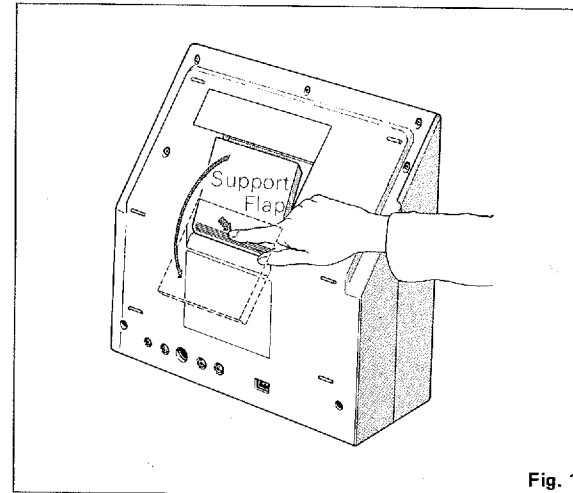

Fig. 1

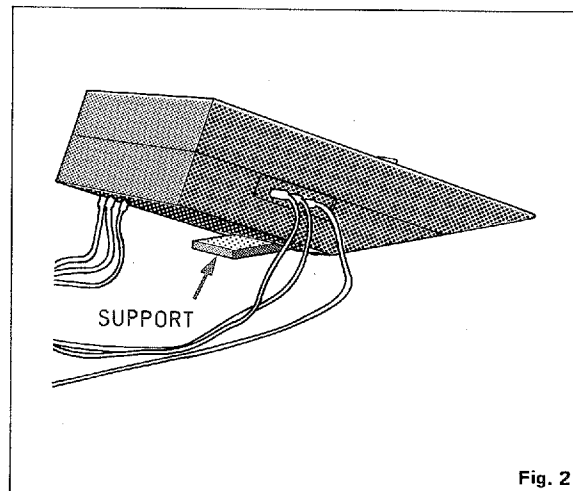
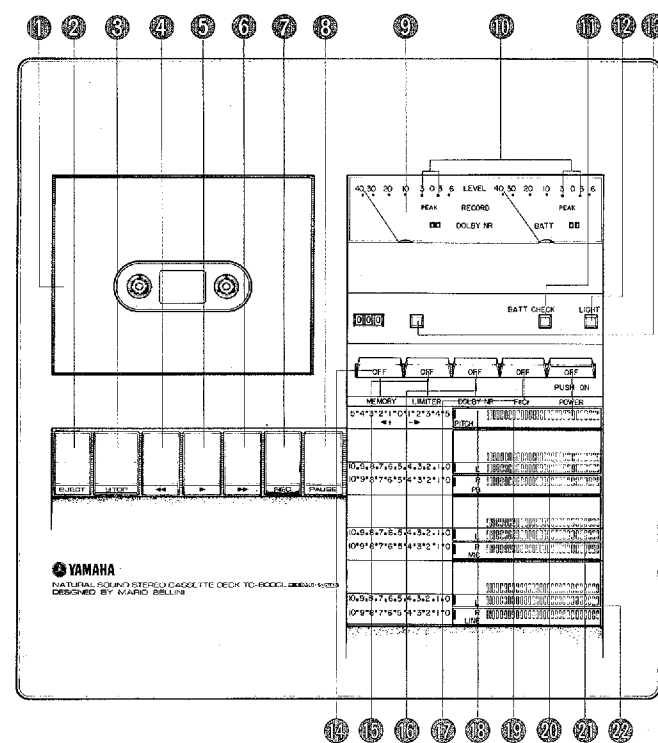

Fig. 2

## PARTS & CONTROLS

### \* FRONT PANEL



#### ① CASSETTE POCKET

Insert the cassette here to play. When the Eject key is pushed, this pocket pops up.

#### ② EJECT KEY

To remove the cassette from the pocket press this key. Be sure to press the Stop key first, so that the tape is not moving when the Eject key is pressed.

#### ③ STOP KEY

Press this key to stop the tape during Play, Record, Fast Forward or Rewind modes.

#### ④ REWIND (◀◀) KEY

Use this key to rewind the tape. If you wish to press the Fast Forward key after rewinding, be sure to first arrest tape motion with the Stop key.

#### ⑤ PLAY (▶) KEY

Press this key alone to play the cassette in the pocket.

This key must be pressed at the same time as the Rec key for recording.

#### ⑥ FAST FORWARD (▶▶) KEY

This key will advance the tape at high speed. If you wish to press the Rewind (◀◀) key after the fast forward is used, be sure to first arrest tape motion with the Stop key.

#### ⑦ RECORD (REC) KEY

When you wish to record, press this key and the Play (▶) key at the same time.

If this key is pressed during any other mode, the recorded program material passing in front of the head will be erased.

#### ⑧ PAUSE KEY

To stop tape motion temporarily during recording or cassette play, press this key. Press again to restart tape motion.

NOTE: This key is designed to be set in the depressed position when the unit is to be started using a timer connected to the power source.

#### ⑨ LEVEL METERS

The meter needles deflect to the right to let you check signal strength during playback or recording. The range of each meter is from -40dB to +6dB. The left meter is for the L channel, the right for R.

#### ⑩ PEAK INDICATORS

The green lights when the level is -3dB or more, the red when the level rises to +4dB or over. For optimum recording, try to keep the level within these ranges (i.e., so that the green light is on and the red is off). This level can be adjusted by setting the Mic and Line In input levels.

#### ⑪ BATTERY CHECK BUTTON

Press this button to check the battery level or the 12V DC power source. The right peak level meter needle will deflect according to the power strength. Power is sufficient if the needle deflects into the blue zone.

#### ⑫ LIGHT BUTTON

During battery or DC operation the level meter lamp will light when this button is pressed. In order to save power, however, the lamp will slowly fade out in approximately 3 seconds.

#### ⑬ TAPE COUNTER RESET BUTTON

Push this button and the tape counter will be reset to "000".

This will make it easier to refind the beginning of a program during recording or playback.

#### ⑭ MEMORY STOP SWITCH

This feature is ideal when you want to replay a just-recorded passage, or when you want to

listen to the same portion of a cassette more than once. Set the Memory switch on (depressed) and reset the counter to "000" at the beginning of the passage. Then, when you have finished the passage (recording or playback), press the Rewind key. The tape will wind back to the "999" point, permitting you to restart from "000."

**15 LIMITER BUTTON**

If the input level is too high during recording, sound distortion will occur. Setting this button on will suppress these excessive peaks to cut distortion.

**16 DOLBY SWITCH**

Press this tape to record or play back a tape using the Dolby noise reduction system built into the TC-800GL. This system will reduce tape hiss and background noise during low-volume passages. Be sure the Dolby switch is off when playing a cassette which was not recorded using the Dolby system.

**17 TAPE SELECTOR SWITCH**

This selector can be switched to make the most of the different characteristics of FeCr and low noise tapes. When the selector is depressed it is set for FeCr, and when it is out it is set for low noise tape.

To play chrome (CrO<sub>2</sub>) tapes, no switchover is necessary as long as the cassette has the extra hole on its rear edge (see Fig. 4). A special sensor on the TC-800GL will detect that a CrO<sub>2</sub> cassette is being played, and will set the bias accordingly.

**NOTE:** To play or record a CrO<sub>2</sub> cassette without this extra hole, set for FeCr tape.

**18 POWER SWITCH**

Press to switch on the unit during AC or DC operation.

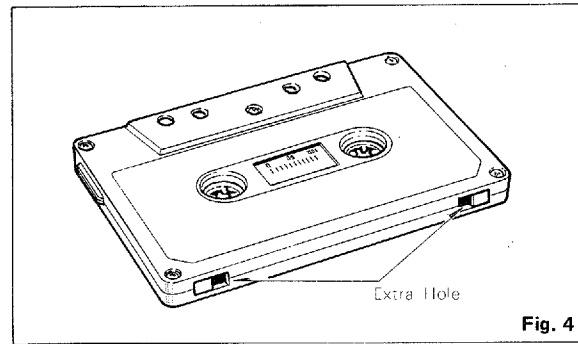

Fig. 4

**19 PITCH CONTROL**

During playback the slide can be used to adjust the pitch  $\pm 3\%$  from the central ("O") position. The central position can be felt by a click stop. Use the Pitch control to match the cassette pitch to another instrument (i.e., piano, etc.). During recording the pitch control has no effect.

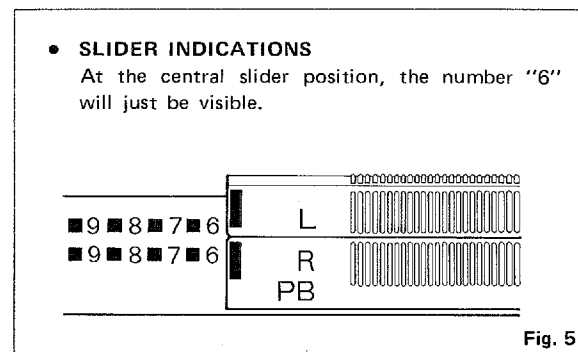

Fig. 5

**20 PLAYBACK LEVEL CONTROLS**

During playback, the volume level of the left and right channels can be adjusted together or separately using these sliders.

**21 MICROPHONE INPUT LEVEL CONTROLS**

When recording using the microphone, adjust the input volume with these sliders while watching

the level meters. Left and right inputs can be adjusted independently.

**22 LINE INPUT LEVEL CONTROL**

When recording the program source coming in through the Line In jacks, control the level using these sliders and watching the level meters. Left and right inputs can be adjusted independently.

**USING A TIMER**

1. Plug the TC-800GL power cord into the timer. Plug the timer power cord into an electric outlet.
2. Set the timer to the desired time.
3. Set the TC-800GL Power switch on (depressed). The power will not come on at this time.
4. Depress the Pause key.
5. Press the Play and Rec keys together.
6. Adjust the Line level control for the proper input level. Be sure you do not accidentally switch the TC-800GL power off.
7. When the recording is finished and the end of the cassette reached, the auto-stop mechanism will switch the TC-800GL off automatically.

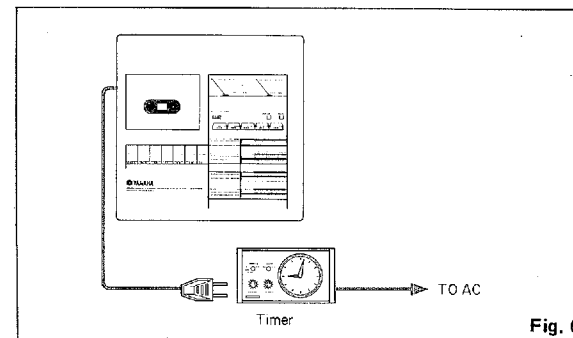
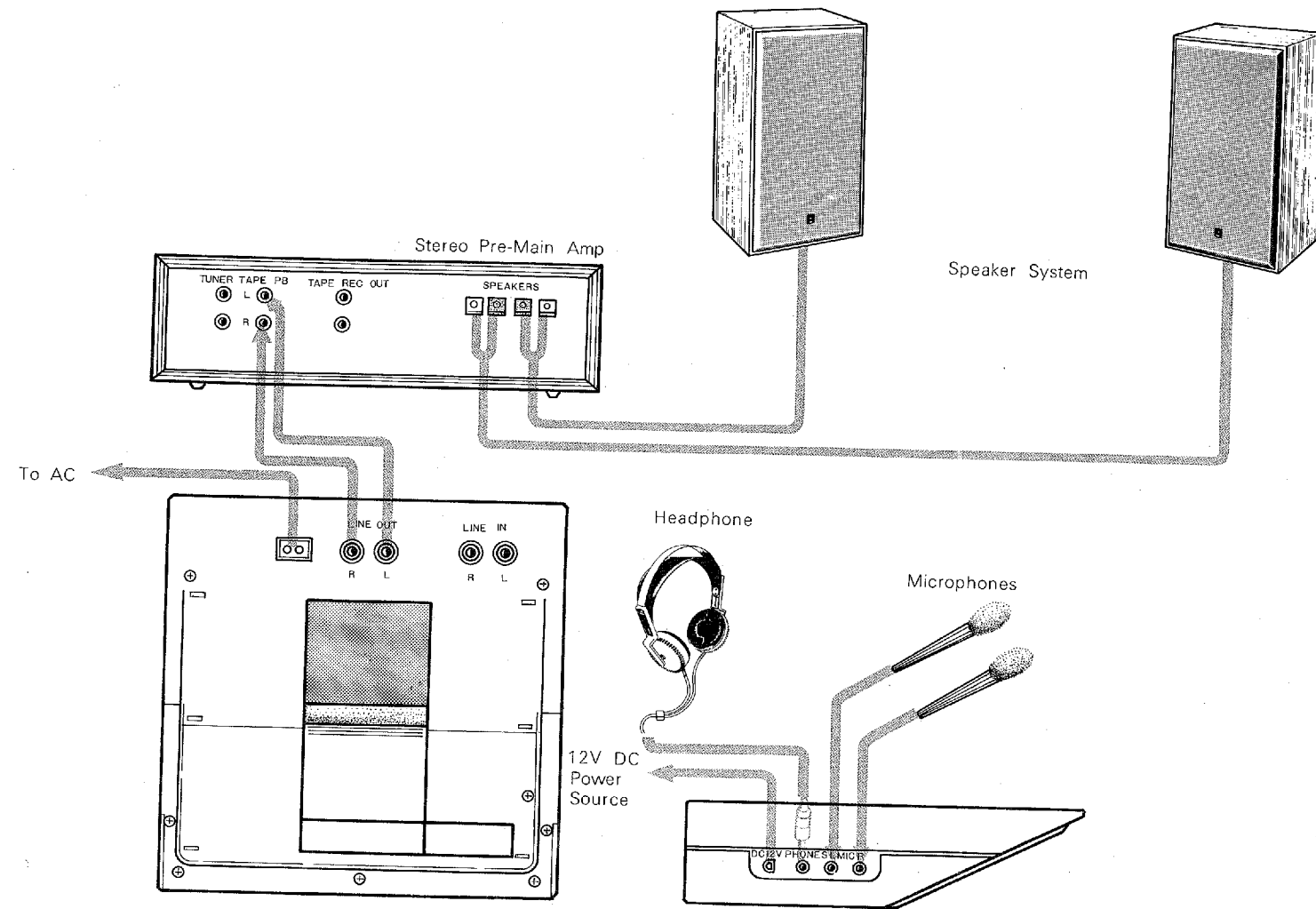

Fig. 6

PLAYBACK



## TO PLAY A RECORDED TAPE

1. Make sure the power source, headphone, amplifier and speakers are all correctly connected according to the above diagram.
2. Switch on the power.
3. Slip the cassette into the pocket.

Pushing the Eject key ① causes the cassette pocket ② to jump up.

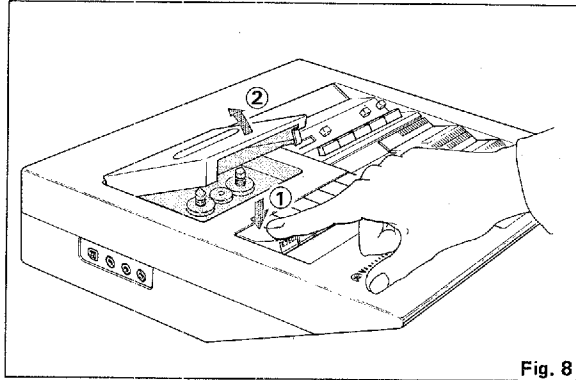

Fig. 8

The side of the tape you wish to hear should be up. Push the tape into the pocket ③ and then snap down the pocket ④.

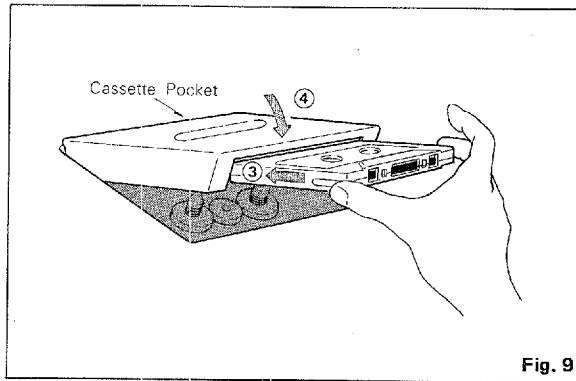
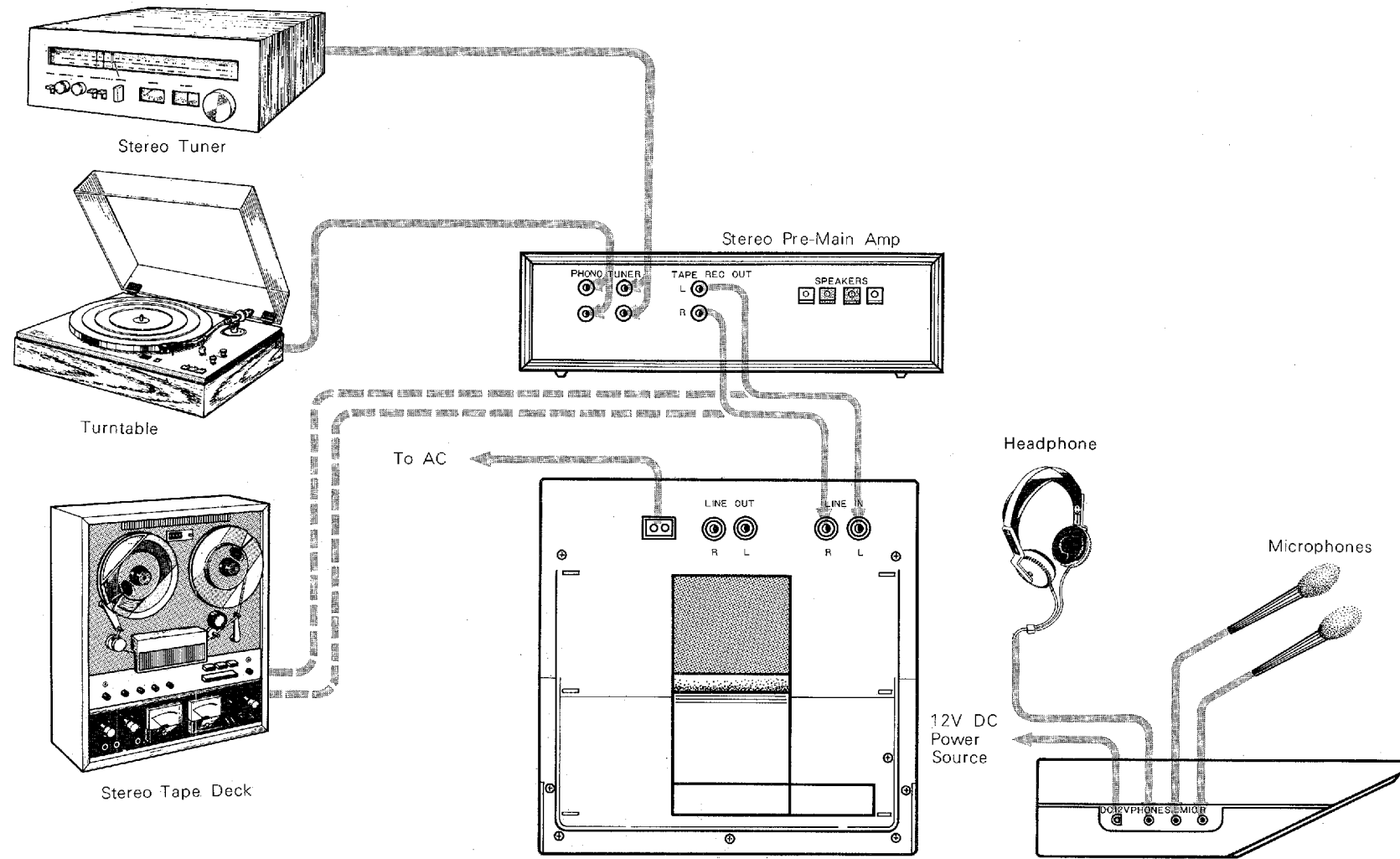

Fig. 9

4. Set the Tape Selector switch and Dolby switch according to the type of tape and whether it was recorded with or without the Dolby system.
  5. Press the Play key and the tape will begin to move.
  6. Watching the level meters, adjust the Playback level slider (adjust for a maximum of +3dB).
  7. Set the amplifier volume and tone controls for the most pleasing sound.
  8. When the whole tape has played and is on the takeup reel, the auto-stop mechanism will shut off the TC-800GL. To listen to the other side, press the Eject key, take out the cassette, turn it upside down and reinsert it.
  9. To stop play at any time, simply press the Stop key.
- **FAST FORWARD:** Use it to skip over certain passages during playback.
  - **REWIND:** Use this key to return the tape, to listen to the same passage again. The auto-stop function also works during rewind, when the end of the tape is reached. The Auto-stop feature will not work during battery or DC operation, only with AC power supply.
  - **PAUSE:** Use this key to temporarily stop play at any point.
- NOTE:** The Pause can be cancelled by pushing the button once again, or by use of a timer when the Power switch is set on (see pg. 4).

# RECORDING





#### BEFORE RECORDING

1. Make sure the power source, microphones, amplifier, etc. are all correctly connected according to the diagram.
2. Switch on the power.
3. Set the cassette in the pocket.
4. Set the tape selector to LH or FeCr, according to the type of tape being used. See pp. 5 and 21. Set the Dolby switch on if you wish to use the Dolby system for recording.
5. Just before beginning your recording, press the tape counter reset button to set the counter at "000."
6. Watching the level meters, adjust both left and right input controls (for microphone or line, whichever is being used as program source) for the proper level. Set so that the green Peak indicator stays on, but the red stays off (pp. 4, 21). When using only one signal source (microphone or line), be sure the level controls, for the unused source are set to zero.  
These indicators are convenient because they flash to signal peaks which are too fast for the meter needles to follow.  
The red indicator shows when the signal reaches +4dB, which is close to the level at which the signal will be distorted if recorded.
7. During live recording, etc., if an excessively large input occurs, overload distortion can result. To guard against such an eventuality, switch on the Limiter.
  - To use the Limiter function, first adjust the input level control so that the maximum peaks do not exceed +3dB on the meters, then switch on the Limiter button.

#### TO BEGIN RECORDING

8. Once the input level is set, press the Play and Rec keys at the same time.
9. When the recording is finished, press the Stop key.
10. To record on the other side of the cassette, eject it, turn it over and reinsert it.

#### MIXED RECORDING

The TC-800GL incorporates separate microphone and line input circuits, permitting the signals from both to be mixed during recording. For mixed recording, follow recording steps 1–10 above, but make sure that the mic input and line input level controls are set to the same level (watch the level meters).

## BATTERY INSERTION

1. Turn the TC-800GL over and open out the support. This will expose the battery compartment cover, which should also be opened (see Fig. 11).
  2. Insert nine UM2 batteries. Observe the proper polarity for each battery; the polarity is marked on the under side of the support, as shown in Fig. 11.
  3. Once the batteries are in place, replace the battery compartment cover.
- The batteries will provide approximately two hours (Normal battery) of continuous use for recording, or four to six hours of sporadic use. If the batteries are not to be used for long periods of time, remove them from the set to avoid the danger of damage due to battery leakage.

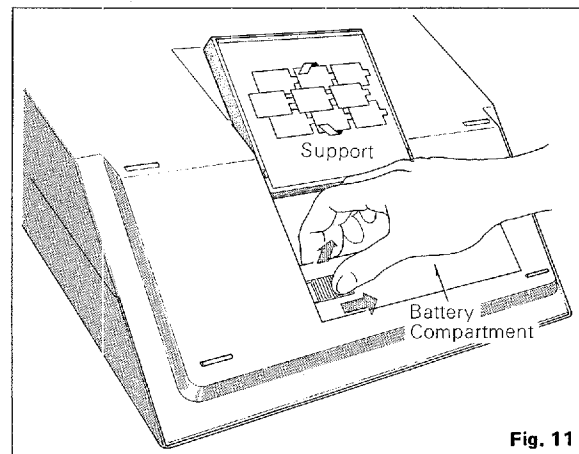

## CLEANING THE HEAD

The TC-800GL incorporates a newly developed super-hard permalloy recording/playback head. It provides excellent signal-to-noise characteristics and low distortion, but this will deteriorate if it is dirty due to being used with old tapes or being exposed to dust. For this reason the head and tape transport system should be cleaned periodically.

Press the Eject key ① and the cassette pocket ② will pop up.

Then clean the head and tape transport system with a cotton swab dipped in head cleaning solution or alcohol.

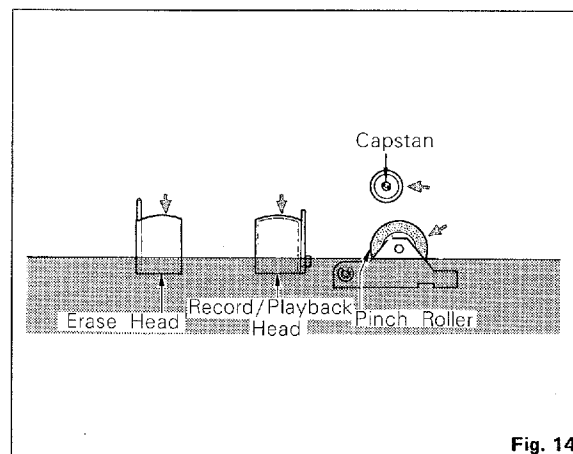
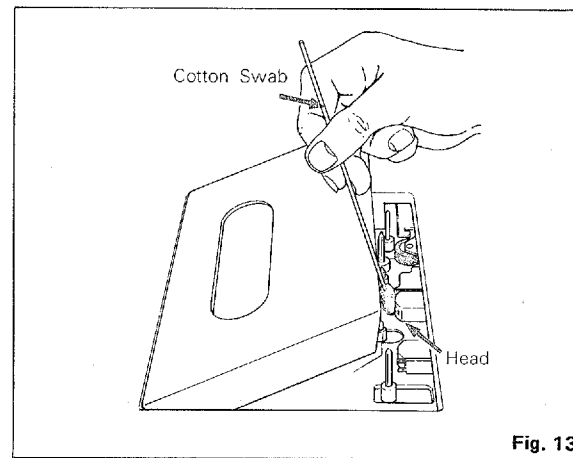
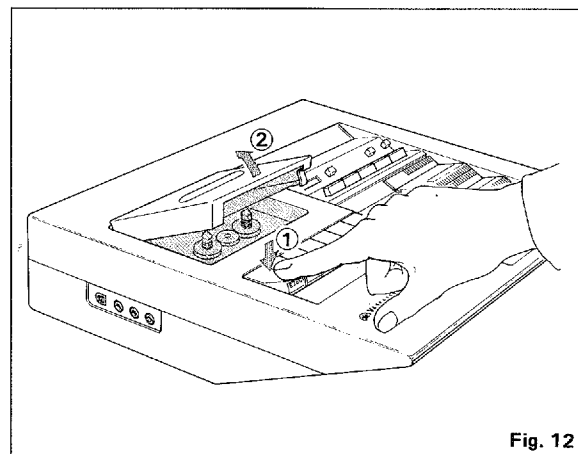

## SPECIFICATIONS

• MECHANISM	
Wow & Flutter	Less than 0.06% (wrms)
Tape Speed	4.8cm/sec.
Speed Deviation	Less than $\pm 1.0\%$
Pitch Control	$\pm 3\%$
Fast Forward/Rewind Time	Within 80 seconds (C-60 Tape)

• AMP SECTION	
Rec/PB Frequency Response	30–13,000Hz (LH Tape)
	30–15,000Hz (CrO <sub>2</sub> , FeCr Tape)
Input Sensitivity/Impedance	Line: 50mV/50K $\Omega$
	Mic: 0.5mV/10K $\Omega$
Signal-Noise Ratio	Over 50dB (0VU)
	Over 58dB (Dolby NR on)
Total Distortion	Less than 2.5% (1KHz, 0VU)
Bias Frequency	85KHz
Channel Separation	Better than 30dB
Line Output Level	0.4V (0VU)
Phones	1mW/8 $\Omega$ , 3mW/150 $\Omega$

• GENERAL	
Semiconductors	45 Transistors, 6 ICs,
	38 Diodes
Power Consumption	AC: 16W
	DC: 7W
Dimensions (W x H x D)	312 x 98 x 312mm (12¼" x 3¾" x 12¼")
Weight	5.0Kg (11 lbs.) without batteries

*Dolby is a trademark of Dolby Laboratories, Inc.*

*Specifications subject to change without notice.*

# Your Mini Cassette Guide

## CASSETTE RECORDING

### POWERFUL AUDIO INPUTS

Since the cassette tape moves at only 4.75cm/sec., and since it is only 3.81mm wide, it cannot handle a wide dynamic range. A powerful input level will lead to distortion, so be careful of excessive signal levels. This is especially dangerous during live music recording, where a limiter like that incorporated into the TC-800GL is convenient to protect against signal surges during dynamic attacks.

### LEVEL METERS & PEAK LEVEL INDICATORS

There are two ways of checking the signal level: with the meters and with the peak level indicators. The indicators are useful for checking pulse-like sounds, while the meters lend themselves most to verifying the level of more steady passages. For this reason, the meters indicate a level approximately 9dB lower than the actual peaks. However, even if you are extremely careful during recording not to let the meter indication surpass 0dB on the scale, distortion during peak surges can still occur. For this reason extreme care is required.

In the TC-800GL the meters are complemented by peak indicators.

The green indicator lights whenever a signal above -3dB is received.

The red indicator shows that the signal level has passed +4dB.

Best recording is obtained when the green indicator is on and the red is off.

### FINDING THE RIGHT LEVEL

Cassette decks are more sensitive than open-reel types to signal level overloading. That is why special attention must be paid to the signal level.

At the same time, if the recording level is too low, background hiss on the tape will become overly noticeable.

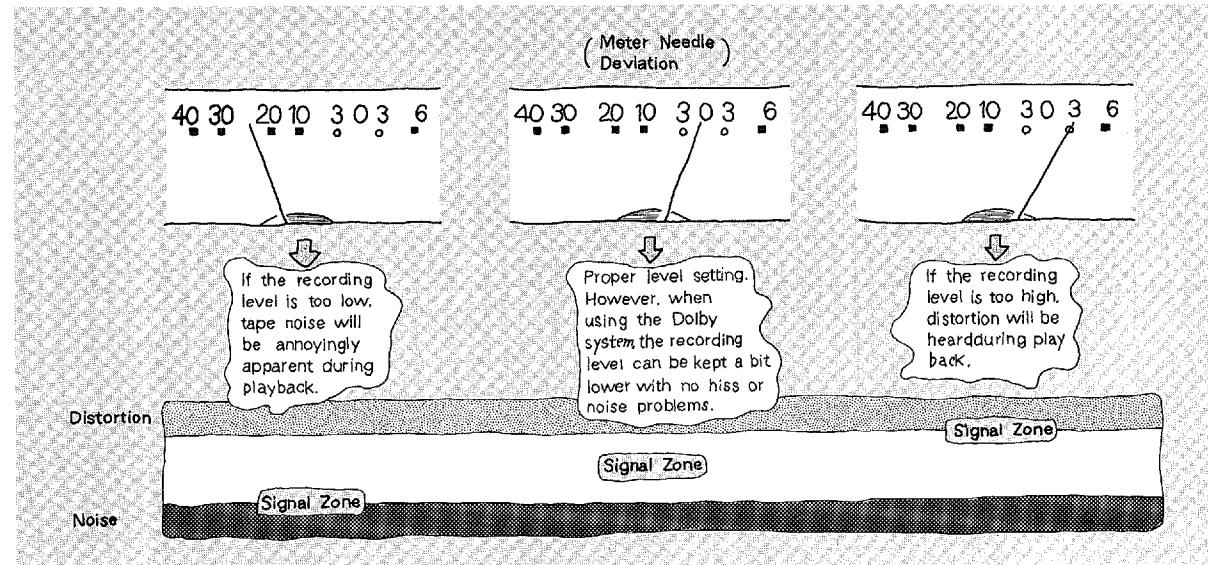

## THE DOLBY\* SYSTEM

In recent years cassette recording and playback have been immensely improved. Cassette mechanisms and sound quality are extremely high today, but nevertheless still inferior to open reel decks in signal-to-noise performance. The characteristic hiss of cassette tapes still bothers many audio fans. The Dolby system was developed to answer this problem. The system's full name is the "Dolby Noise Reduction System." It is based on the following principles:

- A. There are loud and soft passages in any musical selection, and noise bothers us only during the soft passages.
- B. Regardless of loud and soft passages, tape noise and transistor noise always remain constant.
- C. This noise is in the high frequency range, above 500Hz.

Based on these three points a system was devised whereby pianissimo passages (soft signals) have the zone above 500Hz strengthened before recording (thus widening the difference between the signal and noise level). Then, during playback, the system suppresses this same portion, lowering both the signal (back to its original level) and the noise. That is the Dolby system, which cuts noise and tape hiss, as the charts to the right show, thus correcting the main weak point of cassette recording. Successful application of this system can provide recording and playback quality rivaling open reel tape decks.

\*Under license from Dolby Laboratories, Inc.

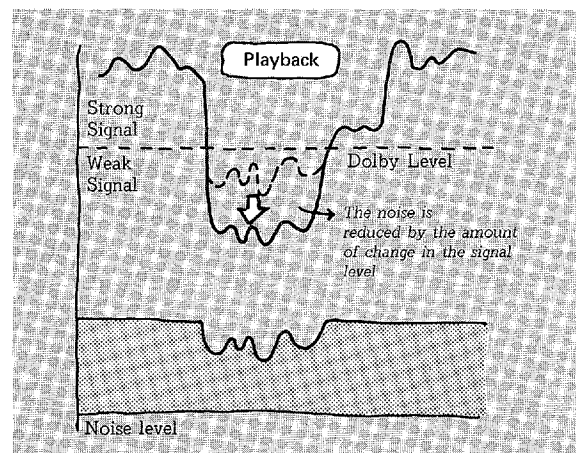
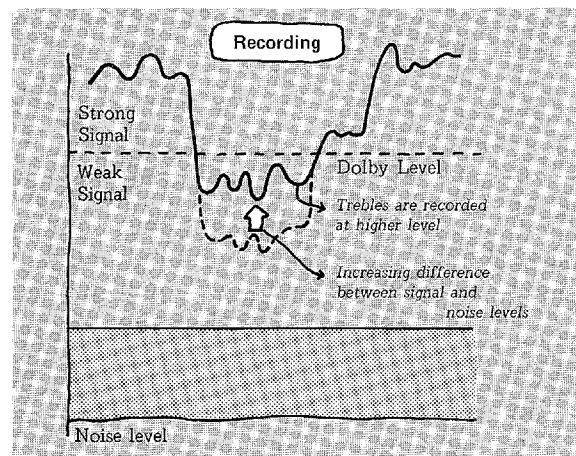

## DOLBY RECORDING & PLAYBACK POINTS

**BE CAREFUL OF EXCESSIVELY STRONG SIGNALS!**

Many of the latest cassette decks are equipped with peak level indicators; if so, set the recording level so that the indicator does not light. On the TC-800GL the recording level should be adjusted so that the green indicator lights but the red does not.

**DOLBY RECORDING MEANS DOLBY PLAYBACK**

Used successfully the Dolby system can reduce noise levels by as much as 10dB, to vastly improve cassette tonal response. But if it is not used correctly, such results will be impossible.

If a tape which was recorded using the Dolby system is played back with the Dolby NR circuit off, the trebles will be unnaturally bright.

On the other hand, if a normally recorded (non-Dolby) tape is played back with the Dolby circuit on, the trebles can be unnaturally reduced and even cut completely.

In other words, Dolby-recorded cassettes should always be played with the Dolby circuit on, and non-Dolby cassettes with the Dolby circuit off. To distinguish, be sure to mark each Dolby-recorded tape in some way so that you will recognize it to set the Dolby circuit switch on for playback.

## YOU CAN BE A MIXER!

### CORRECT MICROPHONE/SOUND SOURCE DISTANCE

#### OFF MIKE SETTING

When the microphone is far from the sound source, the recording configuration is called "off mike."

#### FEATURES

- The sound image is farther away, so the sound as a whole creates a feeling of depth.
- Instrumental balance is excellent, so that harmonies sound quite beautiful.
- Since the sound is picked up both directly and through reflections, the total sound effect is softened.

#### USES

- To achieve excellent recording balance of a large musical group, using two microphones.
- When a concert hall effect is desired.

#### PRECAUTION

- Pay careful attention to the microphone angle when trying to record in stereo from a single point, in order to avoid the "hole-in-the-middle" effect.

#### ON MIKE SETTING

When the microphone and sound source are close, the set-up is called "on mike."

#### FEATURES

- The sound image is close, large and clearly defined.
- A dynamic feeling of live recording is created.
- The closeness of the sound source makes other instrument sounds relatively weak.

#### USES

- When you wish to use only one microphone to pick up the sound from a particular instrument.
- When a distinct sound image is desired.

#### PRECAUTIONS

- When a highly directional microphone is used, be sure it is correctly aimed at the desired sound source.
- Avoid picking up the player's breathing, finger noises, etc., which are not desired.
- This set-up can easily lead to excessively high input level.

### BINAURAL RECORDING AND PLAYBACK

"Binaural" literally means for both ears, and binaural sound is a recording and playback system which provides a special signal for each of the listener's ears. In the ordinary stereo system there is only air between a speaker and each ear of the listener, so the sound from any single speaker is actually heard by both ears. The true binaural system is via headphones (for example) where the sound reaches the listener's ear directly from its speaker; the other ear hears only the sounds from the other speaker. In this case the effect is as if the sound originates inside the listener's head. For live recordings the binaural system is particularly effective in creating a feeling of presence.

For binaural recording the microphones must be placed at the same location as a listener's ears would be, and should have a baffle between them as shown in the illustration. Although it appears that the microphones should be 25–30cm apart (the distance between a listener's ears), 60cm separation has actually been found to be best.

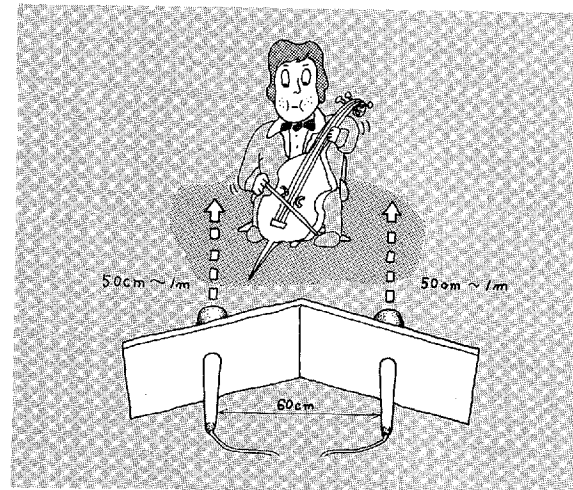

### GRAND PIANO

With the top board open there are two methods of recording: on mike and off mike.

- A. With the microphone separated some distance from the piano (off mike), the balance is more stable and the tone softer.
- B. Set up the microphone so that it is actually inside the piano area and the attacks will come through with full strength and clarity. This is especially useful for jazz recording when definite treble and mid-range clarity is desired.

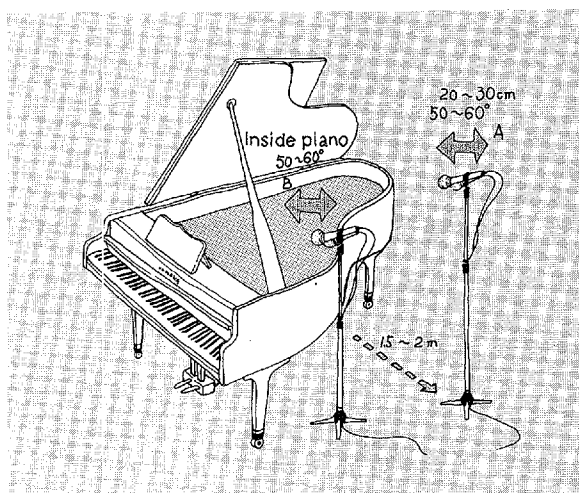

### UPRIGHT PIANO

The normal procedure is to record with the top board open. As with the grand piano, the tone quality of the recording depends upon the arrangement of the microphones.

- A. With the top board open, keep the left and right microphones fairly far away from each other. Be careful that the microphone stands do not get in the performer's way.
- B. Separate the piano from the wall by about 40 or 50 cm. Set up the microphones in this space. A more dynamic sound can be achieved by making use of the reflected sounds. This will be more effective the harder the wall surface is.

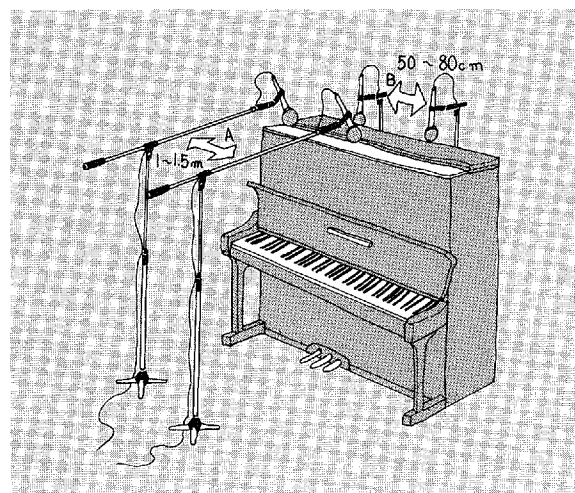

### ELECTRONIC ORGAN (ELECTONE)

Recording of Electone performances can be made either using the microphone placed in front of the Electone speaker, or directly via a line connection. If the microphones are used, be careful not to pick up the sound of the expression pedal being operated. If a combined line/microphone recording is made, a deeper sound can be recorded.

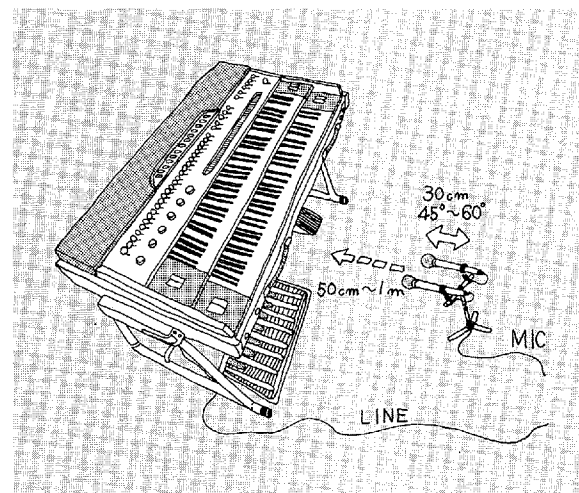



### ONE-POINT CLASSICAL MUSIC RECORDING

This is an appropriate method for capturing the feeling of presence on the stage at a classical music (i.e., a string ensemble, etc.) performance. Use two microphones, but be very careful when adjusting the angle. If the angle is too wide, the center sounds may be lost (the "hole-in-the-middle" effect).

### MULTI-MIKE RECORDING OF JAZZ, ROCK, ETC.

For more clear definition of the instruments in a jazz combo or rock band, trio or quartet, etc., use a multi-microphone set-up. This multi-point system calls for each instrument to have its own microphone; then the relative volume of each instrument is controlled with a mixer, which in this way creates the total sound image and balance. By raising the volume on a solo or feature instrument, it can be accentuated.

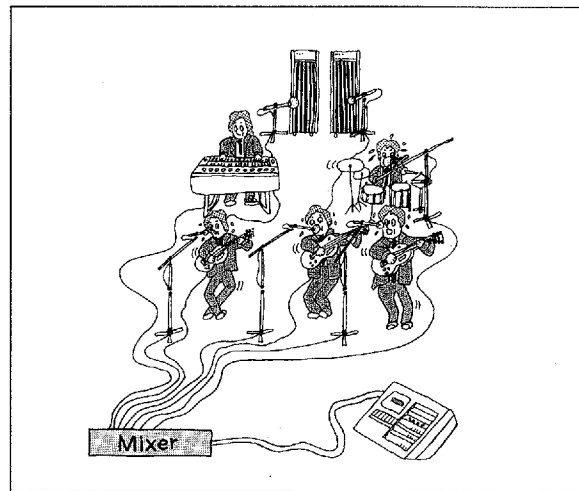
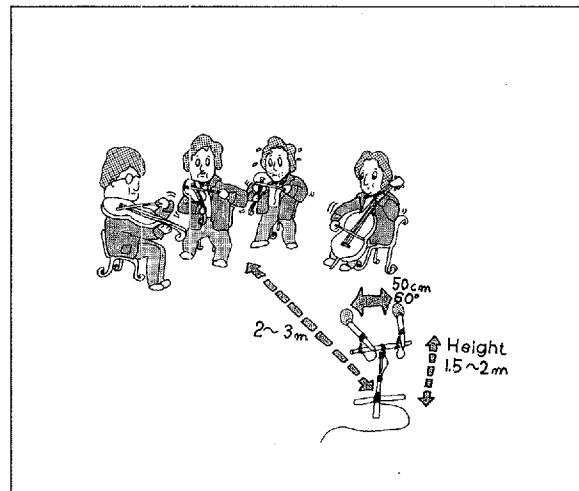

## OUT & AROUND WITH YOUR DECK

A cassette deck is extremely sensitive to vibrations, so if you joggle it while recording the recorded sound can be distorted at that point. For best quality recordings keep the deck stable and level while recording.

The TC-800GL can record for two hours or more on DC operation.

Battery operation is very convenient when you want to use your cassette tape deck outdoors. But don't forget to bring along enough batteries.

For recording the cries of birds and insects it is best to use a parabolic reflector microphone set. If none is available, a vinyl umbrella will serve quite well. The microphone should be mounted along the shaft facing the umbrella part (i.e., facing away from the sound source).

If a rush of air strikes the microphone directly it can cause a hissing sound. During outdoor recording, vocalists, always use a windscreen. It can be made out of an old stocking or similar material.

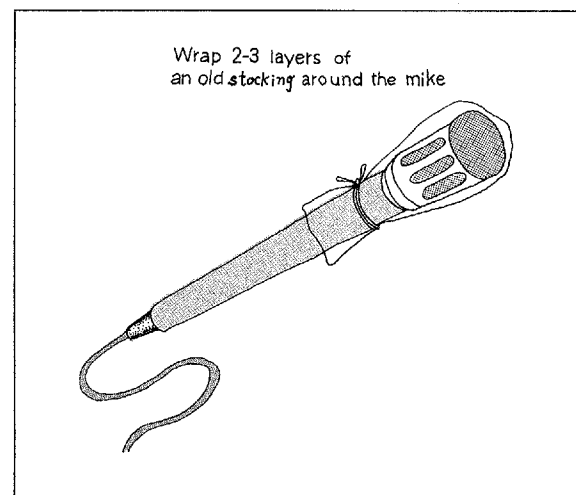
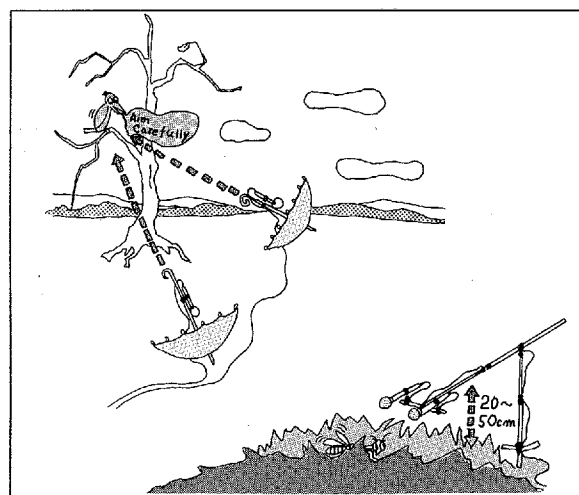
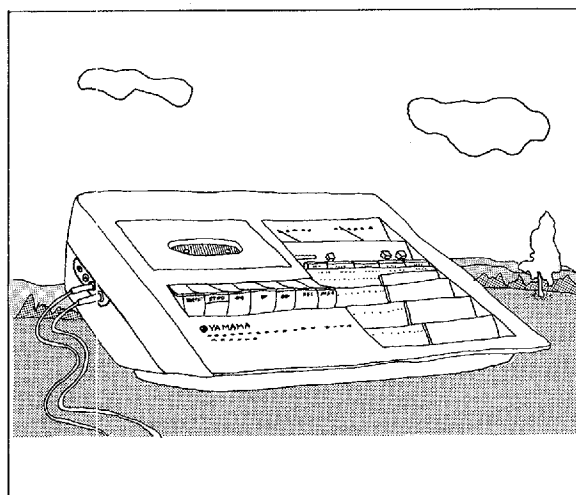

## FM RECORDING

FM recording should be done via a line connection. This is because no matter how good the quality of the FM stereo broadcast and the cassette deck performance, a satisfactory recording is not possible if reception conditions are poor. So the first thing to verify is that the FM signals are being received as clearly as possible. Use a good quality tuner and make sure your antenna is properly positioned.

### MAKE THE MOST OF DIRECT RADIO SIGNALS

Like light waves, electric waves become geometrically weaker with distance. But in the case of FM signals, you can compensate for being a long distance from the broadcast station by using a special FM antenna with 3-7 elements, mounted as high as possible.

This multi-element type of antenna is extremely directional, so be very careful to properly aim it toward the FM station. Connect to the tuner with a coaxial cable.

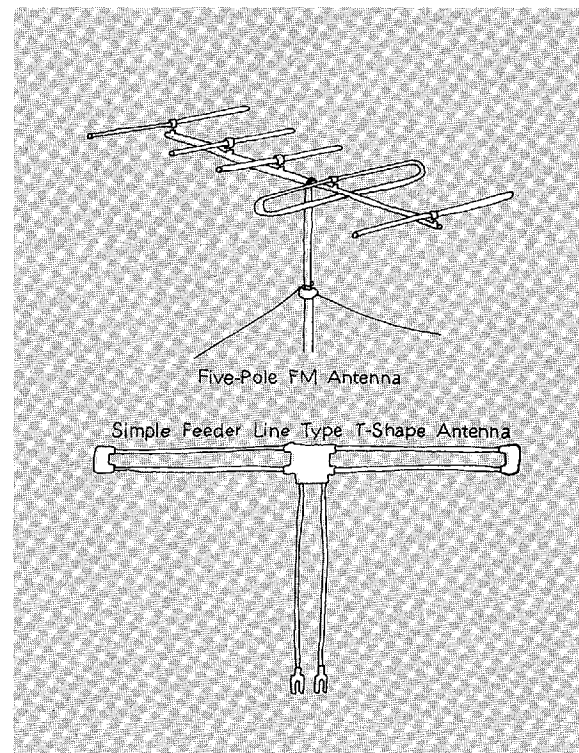

### SHUT OUT MULTIPATH RECEPTION!

In a strong signal area near the FM broadcast station, a simple T-shape feeder line antenna will be sufficient. But care must be taken to avoid reception of waves reflected off of nearby buildings or mountains. These waves interfere with the (desired) direct signal and cause "multipath" distortion. At the same time, if there is interference from noise-causing elements (i.e., automobile ignitions, etc.), or the signal is blocked by a building, a multi-element antenna is probably required. If the signal is excessively strong, this can be corrected by installing an attenuator between the antenna and the tuner.

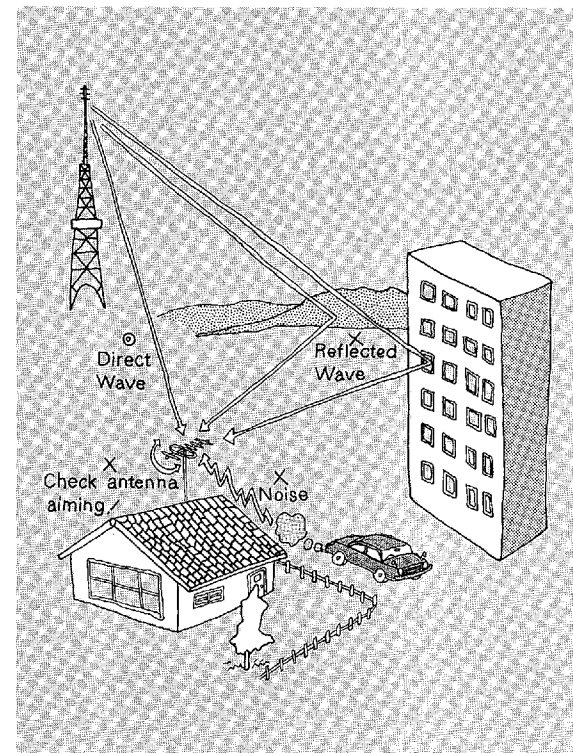

## THE TAPE MECHANISM

Cassettes and tapes are manufactured to agreed international standards. The cassette measures 100 x 64 x 12mm. It sets on the feed and take-up reels, and the tape inside travels at 4.75cm/sec.

If the tabs on the back edge of the tape are broken out a spring is released in the mechanism, blocking the record function even though the tape still moves. This helps you protect recorded tapes from accidental re-recording.

Cassettes are numbered according to the tape length: C-60, C-90, C-120, etc. The numbers indicate the minutes of recording time available when both sides of the cassette are used. For high quality recording do not use a tape longer than C-90.

CASSETTE MODEL	TAPE THICKNESS	TAPE LENGTH	BASE
C- 60	Under 18 $\mu$	90m	Polyester
C- 90	12 $\mu$	130m	Polyester
C-120	9 $\mu$	180m	Polyester

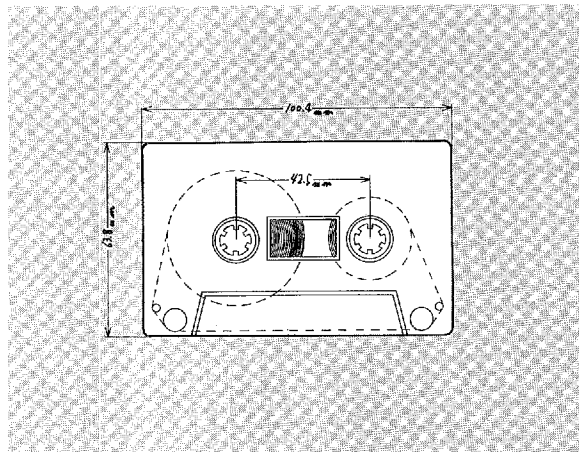
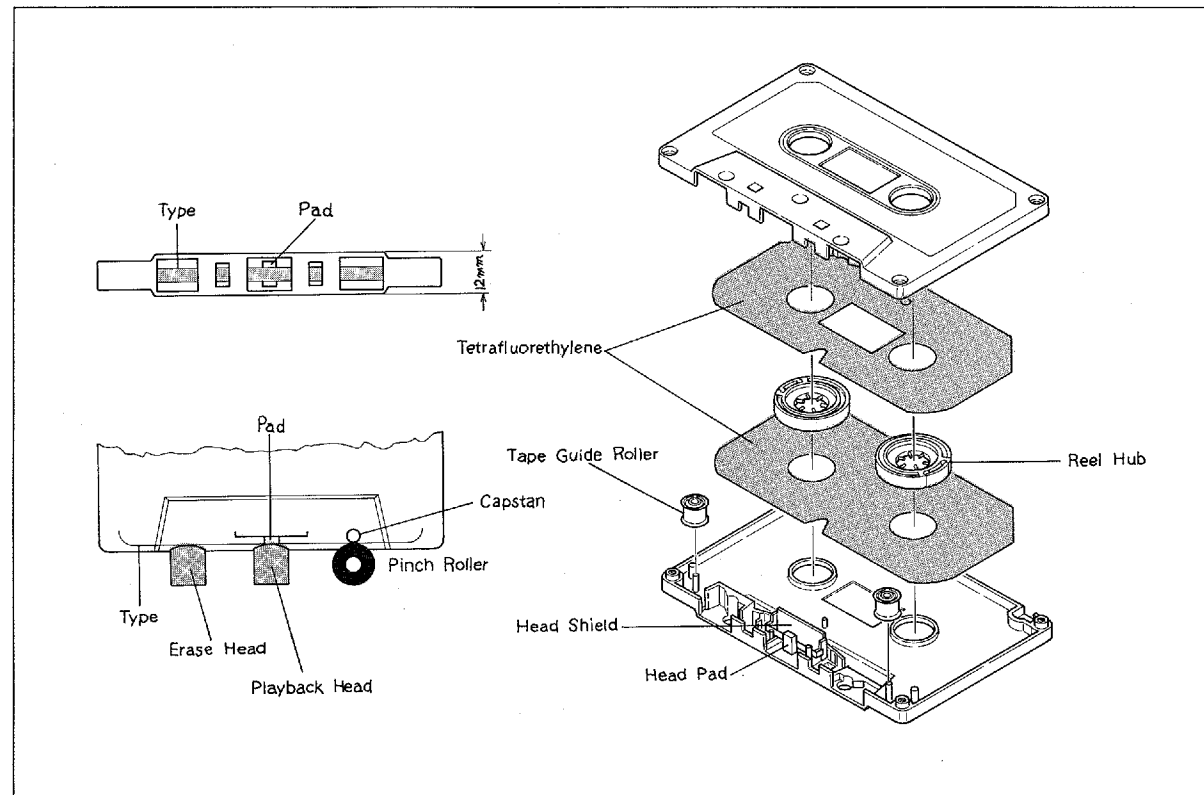

## CASSETTE TAPE & SELECTORS

There are several types of cassette tape: normal, low-noise (LH), chrome, ferri-chrome, etc. If the selector on the cassette deck is not set to the correct position for the tape being played, optimum sound quality will not be gained.

The TC-800GL has only a Ferri-Chrome (FeCr) selector. This is because bias and equalization switch-over is automatic for chrome tape. Since chrome tape cassettes have an extra hole on the rear edge, the TC-800GL will sense this and switch for best recording and playback performance whether the selector is set to FeCr or Low Noise (LH).

### TAPES AND LEVEL INDICATORS

Optimum recording conditions vary according to the type of tape. These conditions are outlined in the following chart.

	L · H	CrO <sub>2</sub>	FeCr
GREEN	Flickers On and Off	Lights from time to time	On almost continuously
RED	Lights from time to time	Lights only infrequently	Flickers On and Off

### TC-800GL RECOMMENDED TAPES

TYPE BRAND	L · H	CrO <sub>2</sub>	FeCr
MAXELL	UDC-60, UDC-90 UDXLC-60, UDXLC-90	CRC-60 CRC-90	
T·D·K	SDC-60, SDC-90 EDC-60, EDC-90	KRC-60 KRC-90	
AGFA	C-60 SHD C-90 SHD	C-60 C-90	
BASF	C-60 LHSM C-90 LHSM	C-60 CRSM C-90 CRSM	
Scotch	C-60 Low Noise High Density C-90 Low Noise High Density		CL-C60 CL-C90
SONY		C-60 CR C-90 CR	C-60 Duad C-90 Duad

## MIXING

The TC-800GL has both Mic and Line inputs. This permits mixed recording, so you can record yourself singing along with your favorite artists. Feed the record or tape signal in through the Line input jacks, and connect the microphone(s) to the Mic jack(s). Furthermore, if you have two recording decks you can make multiple recordings.

In addition, if your amplifier has mic mixing capabilities, you can increase the number of microphones to three or four at a time.

- When recording via microphone(s), be sure to set all unused Line input controls to minimum. When recording via the Line inputs, turn the Mic volume to minimum.

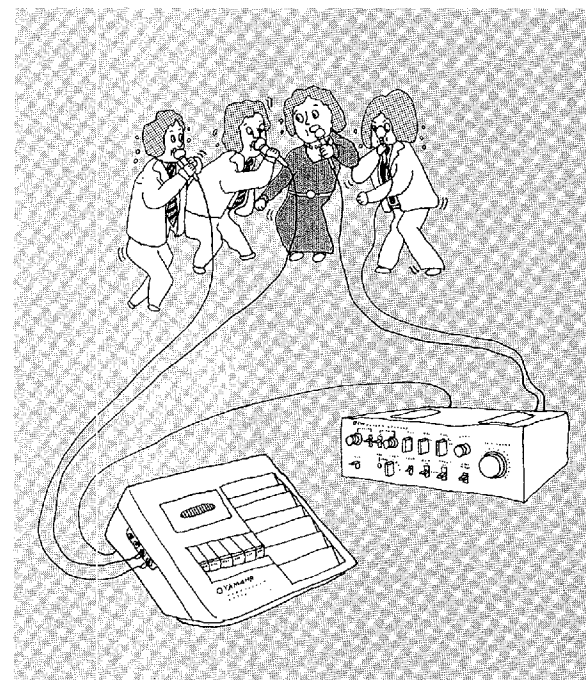

## DUBBING

### DISC RECORDING

General recording procedures are explained on PP. 8–9. Make sure your record is as clean and free from dust as possible.

Before recording, check the level of the record by playing part of it: at this time the amplifier and TC-800GL should be on, with the amp mode key set to phono and the deck REC key depressed. The level will show on the meters and LED indicators, letting you adjust the input slider.

When you are ready to record, first depress the pause key, then the REC and PLAY keys together. Start the record and wait until the stylus is in the groove (you can hear the sound via the speakers or head-phone). Then, before the music begins, press the pause key to release it, beginning recording.

If you record both sides of a record on one side of the cassette, stop tape travel with the pause key instead of the stop key while you turn the record over; there will be no annoying “click” in this case.

### TAPE TO TAPE

There are two methods of recording from tape to tape. If your amplifier has two sets of tape deck jacks and provides dubbing possibilities, then you can dub by leaving both decks connected to the amplifier. A-B dubbing will be done with deck A output jacks and deck B input jacks.

On the other hand, a simpler method is to connect the Line Out and Line In jacks of the tape decks directly. Since there are controls for both the input and output levels, first set with the playing deck controls (output), and then with those on the recording deck (input).

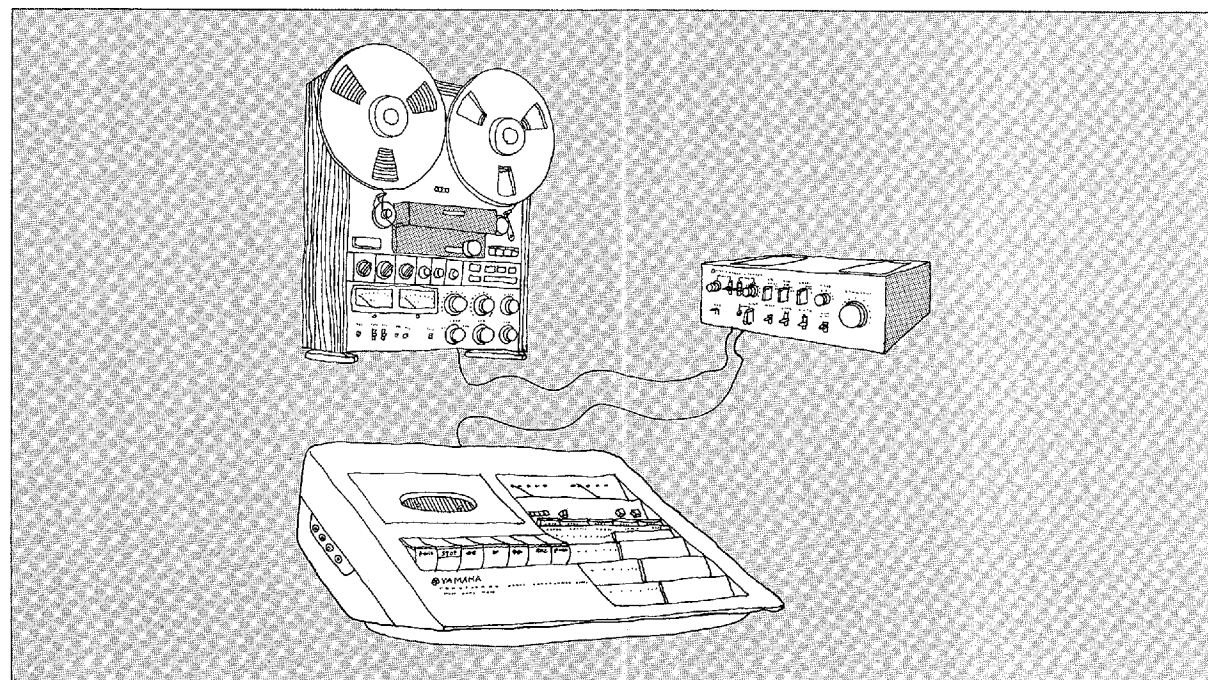

## CASSETTE DECK CARE

### HEAD CLEANING AND DEMAGNETIZATION ARE EXTREMELY IMPORTANT!

The cassette tape is extremely narrow, so that if any dirt adheres to the head, or it becomes magnetized, this soon shows up in various ways, and high-quality recording and playback will be impossible.

When cleaning the head be very careful not to scratch it. Avoid using anything hard, like metal. Furthermore, when demagnetizing the head make sure the deck power is switched off, and do not let the demagnetizer touch the head.

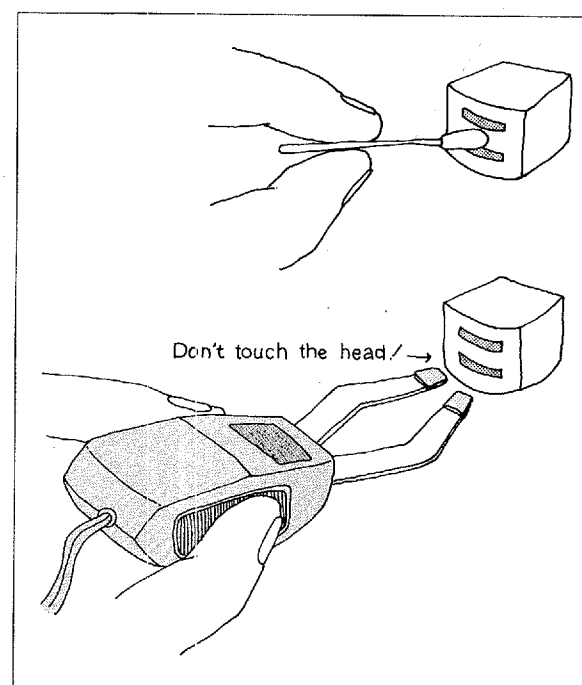

### DON'T PUT YOUR DECK IN PLACES LIKE THIS!

Just as your records and stereo set, your tape deck must not be placed in a location exposed to high heat or humidity. If the deck is set for long periods on top of an amplifier trouble can also occur, so take care to have a safe, rational stereo layout.

Also, do not place the unit in an area exposed to magnetic charges, to protect both cassettes and the deck.

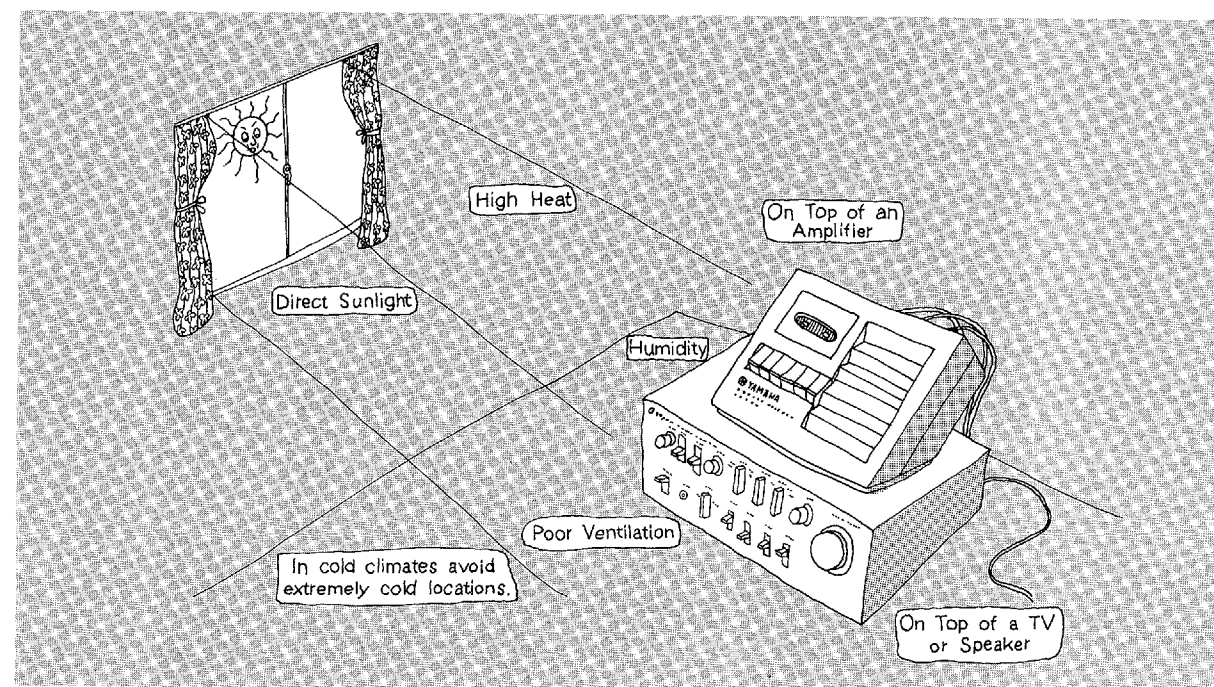

## TROUBLESHOOTING

### RECORDING TROUBLES

#### ● RECORDING COMPLETELY IMPOSSIBLE

Check whether the tab(s) on the rear edge of the cassette have been broken or not. Also check whether the deck has been set for recording. Are the mic and line jacks connected the way they should be? Are the proper controls turned up?

If all the above checks are normal, take a close look at the microphone(s). If it is an electret or condenser type chances are the battery is used up. If all the above check out normal, the problem is probably in the recording amplifier, so see your service man.

#### ● RECORDING DISTORTION

Are all cords firmly connected? Is the input level too high? If the distortion occurs only during microphone recording, but not when using line connections, check the microphone. On the other hand, if the problem occurs with line only, then the connected unit should be checked. Next, make sure the head is not dirty or magnetized. Clean and demagnetize the head if necessary. Are you using a good quality tape? Preparatory mistakes like setting the tape selector to the wrong position are common, so carefully check every point. If the distortion still persists, see your service agent.

#### ● HARD-TO-DISCOVER PROBLEMS

If the shielded cable connecting the amp and tape deck is too long, high-range response may be fuzzy. This is because the cable capacitance is added in parallel with the amplifier signal circuit, reducing treble response. Even with a low static capacity cable, the length should be kept within 4 meters. More than this is dangerous.

In addition, if you are using a tape recorder which permits recording from only line or microphone, but not both, be sure the volume for the input

not in use is turned completely down. Otherwise optimum signal-noise characteristics will not be possible.

### PLAYBACK TROUBLES

#### ● NO SOUND OR DISTORTED SOUND

First check basic points: cord connection, amplifier tape monitor switch setting, speaker connections, etc. Then make sure the problem was not in the recording stage.

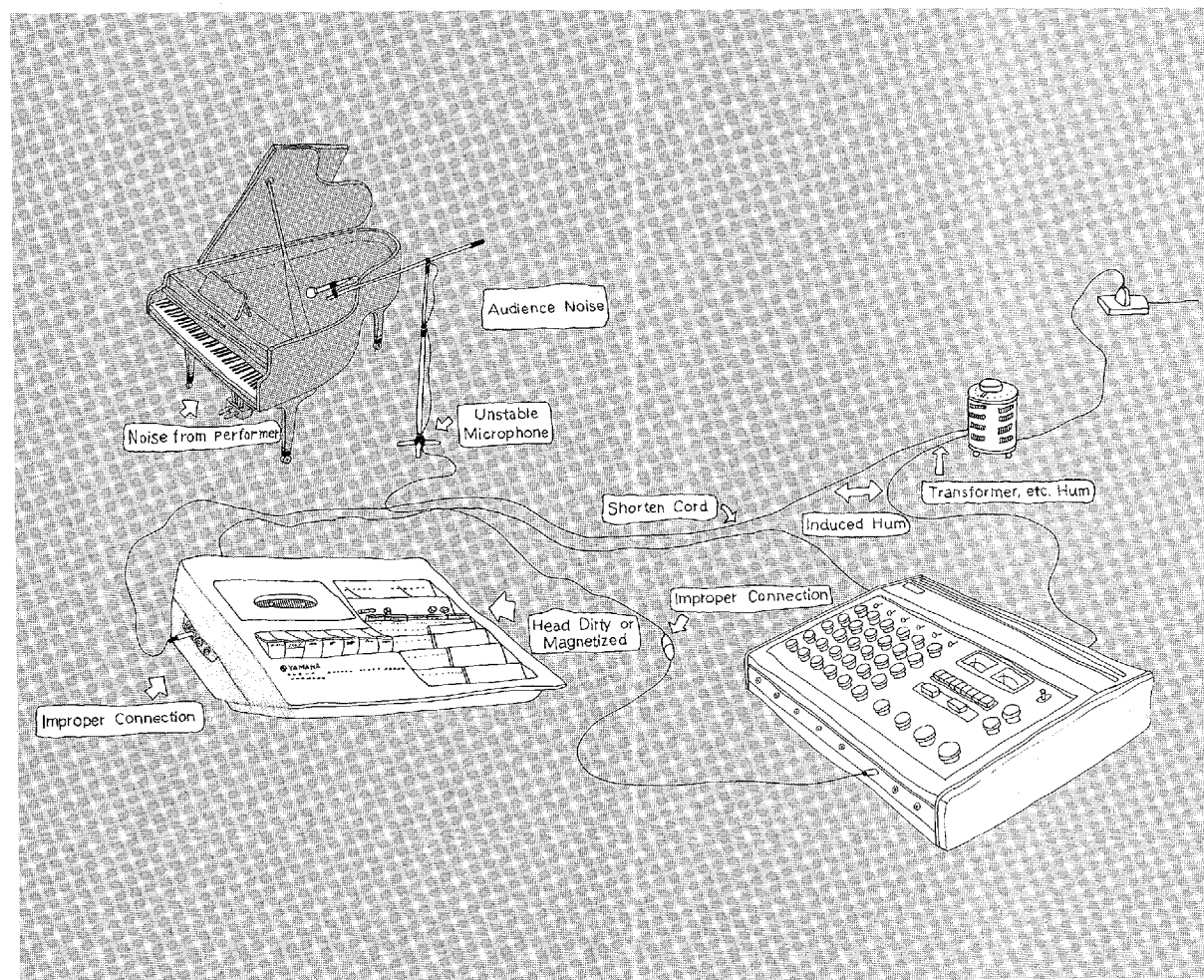



## CASSETTE QUESTIONS & ANSWERS

**Q:** During a live recording I plugged the microphone into the headphone jack by mistake. Since then the microphone has not performed right....

**A:** This problem differs according to the type of microphone. With dynamic and certain other types, an input through the plug can ruin the microphone. Anticipating this type of problem, some condenser microphones have built-in protection, but such microphones are quite delicate and must be used with care.

At any rate, a microphone damaged by a simple mistake was not intended for amateur use. Contact a microphone specialty store for a proper type.

**Q:** What is the expected life of a cassette tape?

**A:** That depends upon the quality and condition of the cassette deck, the tape quality, conditions of use, etc. An exact answer in years and months cannot be given. Recent developments in base material also mean that the tape can stand up to many more plays. If you are careful not to allow dirt, mold, etc. to get on the tape, it can be used dozens of times.

**Q:** How do I record the sound from TV programs?

**A:** Some televisions have both earphone and multiplex output jacks. While the multiplex jack is not the best possible answer, it permits recording. The earphone jack connected to the tape deck Line In jack, however, is not appropriate for recording. This is because the earphone output level is extremely high and its impedance very low — on the level of  $8\Omega$ . If there is no other method than using the earphone jack, install a resistor between the jacks to match the impedance and the level. This can be done using a special cord available in your audio store.

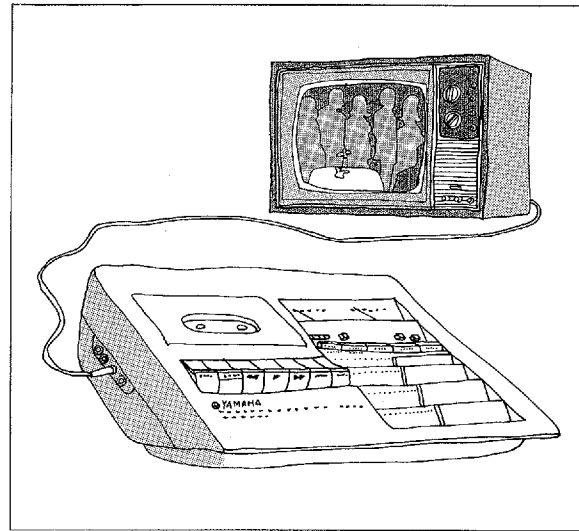

**Q:** What's the difference between  $600\Omega$  and  $50K\Omega$  microphones?

**A:** The microphone output impedance expresses the load impedance. Recently  $600\Omega$  types are standard; these are low impedance types, whereas  $50K\Omega$  is high impedance. With high impedance types be careful of using long cords or of locations where noise is a problem. While it is possible to use a low impedance microphone with a high impedance input jack, be careful to match the output level of the microphone and the tape deck input level.

**Q:** What do the terms "SN ratio" and "residual noise" that I see so often in catalogs and owner's manuals mean?

**A:** SN means "signal-to-noise." It is the relative strength of the audio signal compared to the noise content. The higher the figure the better. Residual noise is that which is created even when the amplifier or deck volume is turned down to minimum.

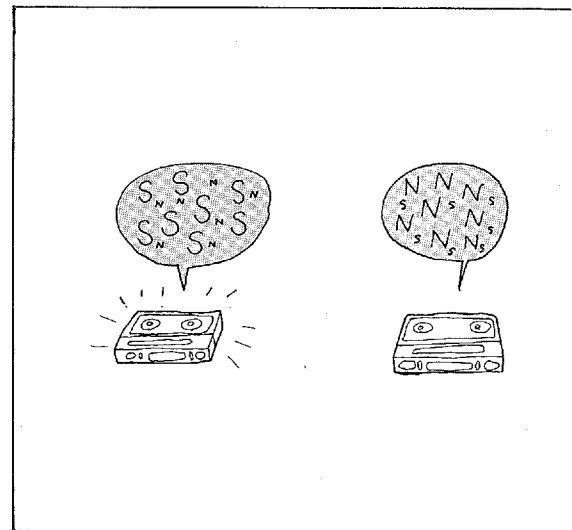

**Q: When I record over a previous program on my cassette, the previous program can still be heard. What should I do?**

A: This signifies a problem with the deck's erase head. First check that the erase head is not dirty. Then, before recording, erase the previous program and then play the tape. If you still hear a remaining sound, something is wrong with the erase head circuitry in the deck.

**Q: I enjoy recording FM broadcasts, but whenever I record a stereo broadcast, the sound becomes distorted. What causes this and how can I correct it?**

A: Compared with monophonic broadcast signals, a stereo signal requires 10 times as much sensitivity. If the antenna input is insufficient (as is often the case with single feeder line antennas), then distortion will occur during stereo broadcasts. Change to a special FM antenna. If the distortion remains, perhaps there is something wrong with your tuner, which must be corrected by sending it out for repair.

**Q: Please tell me about tape care. If I misuse a cassette and it becomes distorted, how can I fix it?**

A: Just as with open-reel tapes, it is extremely important to be careful during rewind. If you allow excessive tautness or looseness during rewind, it can result in tape fouling, curling or stretching. In addition, storing tapes in a location with widely varying temperatures and/or humidity can cause a deterioration of tape quality and accumulation of mold. Once a tape is distorted, it is difficult to correct. If the passage on that part of the tape is not extremely important to you, one solution would be to cut out that section and then splice the tape.

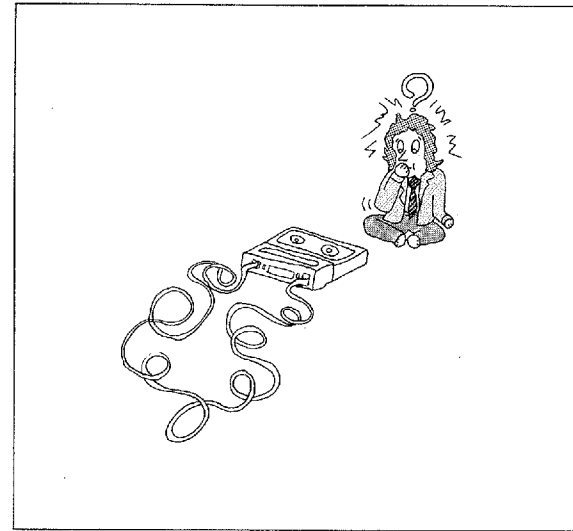

CENTER

SINCE 1887  **YAMAHA**  
NIPPON GAKKI CO., LTD. HAMAMATSU, JAPAN