

YAMAHA RX-300/U

Natural Sound Stereo Receiver

Ampli-tuner stéréo de la série "Natural Sound"

Natural Sound Stereo-Receiver

Natural Sound Stereo Receiver

Ricevitore Stereo a Suono Naturale

CENTER

OWNER'S MANUAL

MANUEL D'UTILISATION

BEDIENUNGSANLEITUNG

BRUKSANVISNING

MANUALE DELL'UTENTE

Die Deutsche Bundespost informiert

Sehr geehrter Rundfunkteilnehmer!

Dieses Gerät ist von der Deutschen Bundespost als Ton- bzw. Fernseh-Rundfunkempfänger zugelassen. Es entspricht den zur Zeit geltenden Technischen Vorschriften der Deutschen Bundespost und ist zum Nachweis dafür mit dem DBP-Zulassungszeichen.....gekennzeichnet. Bitte überzeugen Sie sich selbst.

Dieses Gerät darf im Rahmen der umseitig abgedruckten "Allgemeinen Genehmigung für Ton- und Fernseh-Rundfunkempfänger" in der Bundesrepublik Deutschland betrieben werden. Beachten Sie aber bitte, daß aufgrund dieser Allgemeinen Genehmigung nur Sendungen des Rundfunks empfangen werden dürfen.*). Wer unbefugt andere Sendungen (z.B. des Polizeifunks, des Seefunks, der öffentlichen beweglichen Landfunkdienste) empfängt, verstößt gegen die Genehmigungsaufgaben und macht sich daher nach §15 Absatz 2 a des Gesetzes über Fernmeldeanlagen strafbar.

Die Kennzeichnung mit dem DBP-Zulassungszeichen bietet Ihnen die Gewähr, daß dieses Gerät keine anderen Fernmeldeanlagen einschließlich Funkanlagen stört. Die Zusatzbuchstaben S oder SK bei dem DBP-Zulassungszeichen besagen außerdem, daß das Gerät gegen störende Beeinflussungen durch andere Funkanlagen (z.B. des Amateurfunks, des CB-Funks) weitgehend unempfindlich ist. Sollten ausnahmsweise trotzdem Störungen auftreten, so wenden Sie sich bitte an die örtlich zuständige Funkstörungsmeßstelle.

*) Zum Empfang anderer Sendungen darf dieses Gerät nur mit Genehmigung der Deutschen Bundespost benutzt werden. Allgemein genehmigt ist zur Zeit der Empfang der Aussendungen von Amateurfunkstellen und der Normalfrequenz- und Zeitzeichensendungen.

Allgemeine Genehmigung für Ton- und Fernseh-Rundfunkempfänger

Die Allgemeine Ton- und Fernseh-Rundfunkgenehmigung vom 11. Dezember 1970 (veröffentlicht im Bundesanzeiger Nr. 234 vom 16. Dezember 1970) wird unter Bezug auf Abschnitt III der Genehmigung durch folgende Fassung der Allgemeinen Genehmigung für Ton- und Fernseh-Rundfunkempfänger gemäß den § 51 und 2 des Gesetzes über Fernmeldeanlagen ersetzt.

Genehmigung für Ton- und Fernseh-Rundfunkempfänger

I.

1. Die Errichtung und der Betrieb von Ton- und Fernseh-Rundfunkempfängern werden nach § 51 und 2 des Gesetzes über Fernmeldeanlagen in der Fassung der Bekanntmachung vom 17. 3. 77 (BGBl. I S. 459) allgemein genehmigt.
2. Ton- und Fernseh-Rundfunkempfänger im Sinne dieser Genehmigung sind Funkanlagen gemäß § 1 Abs. 1 des Gesetzes über Fernmeldeanlagen, die ausschließlich die für Rundfunkempfänger zugelassenen Frequenzabstimmbereiche*) aufweisen und zum Aufnehmen und gleichzeitigen Hör- oder Sichtbarmachen von Ton- oder Fernseh-Rundfunksendungen bestimmt sind. Zum Empfänger gehören auch eingebaute oder mit ihm fest verbundene Antennen sowie bei Unterteilung in mehrere Geräte die funktionsmäßig zugehörigen Geräte.

Außer für den Empfänger von Rundfunksendungen dürfen Ton- und Fernseh-Rundfunkempfänger nur mit besonderer Genehmigung der Deutschen Bundespost für andere Fernmeldezwecke zusätzlich benutzt werden.

In den Empfänger eingebaute oder sonst mit ihm verbundene Zusatzgeräte (z.B. Ultraschallfernmeldeanlagen, Infrarotfernmeldeanlagen) werden von dieser Genehmigung nicht erfaßt (ausgenommen die Einrichtungen zum Empfang des Verkehrsrundfunks). Desgleichen sind andere technische Empfängereigenschaften, die über den eigentlichen Zweck eines Rundfunkempfängers hinausgehen (z.B. zum Empfang anderer Funkdienste, für die Wiedergabe im Rahmen von Textübertragungsverfahren), hierdurch nicht genehmigt. Hierfür gelten besondere Regelungen.

II.

Diese Genehmigung wird unter nachstehenden Auflagen erteilt.

1. Ton- und Fernseh-Rundfunkempfänger müssen den jeweils geltenden Technischen Vorschriften für Ton- und Fernseh-Rundfunkempfänger entsprechen. Eingebaute Zusatzgeräte müssen den für sie geltenden Bestimmungen und technischen Vorschriften genügen.

Änderungen der Technischen Vorschriften, die im Amtsblatt des Bundesministers für das Post- und Fernmeldewesen veröffentlicht werden, muß bei schon errichteten und in Betrieb genommenen Ton- und Fernseh-Rundfunkempfängern nachgekommen werden, wenn durch den Betrieb dieser Rundfunkempfänger andere elektrische Anlagen gestört werden.

Serienmäßig hergestellte Ton- und Fernseh-Rundfunkempfänger müssen zum Nachweis dafür, daß sie den technischen Vorschriften entsprechen, mit einer FTZ-Prüfnummer gekennzeichnet sein.**) Die

FTZ-Prüfnummer sagt über die elektrische und mechanische Sicherheit und die Einhaltung der Strahlenschutzbestimmungen nichts aus.

2. Ton- und Fernseh-Rundfunkempfänger dürfen an ortsfesten oder nichtortsfesten Rundfunk-Empfangsantennenanlagen, Verteilanlagen oder Kabelfernsehanlagen betrieben und im Rahmen der Bestimmungen über private Drahtfernmeldeanlagen mit Drahtfernmeldeanlagen verbunden werden.

Auf demselben Grundstück oder innerhalb eines Fahrzeuges dürfen Ton- und Fernseh-Rundfunkempfänger mit anderen Geräten oder sonstigen Gegenständen (z.B. Plattenspieler, Magnetaufzeichnungs- und -Wiedergabegeräten, Antennen) verbunden werden, sofern diese Geräte von der Deutschen Bundespost genehmigt sind oder keiner Genehmigung bedürfen.

Die räumliche Kombination von Funkanlagen mit Ton- oder Fernseh-Rundfunkempfängern ist nur dann zulässig, wenn die betreffenden Funkanlagen je für sich genehmigt sind.

3. Mit Ton- oder Fernseh-Rundfunkempfängern dürfen aufgrund dieser Genehmigung nur Sendungen des Rundfunks empfangen werden, also übertragene Tonsignale (Musik, Sprache) und Fernsehsignale (nur Bildinformationen). Andere Sendungen (z.B. des Polizeifunks, der öffentlichen beweglichen Landfunkdienste, Datenübertragungen) dürfen nicht aufgenommen werden; werden sie jedoch unbeabsichtigt empfangen, so dürfen sie weder aufgezeichnet noch anderen mitgeteilt noch für irgendwelche Zwecke ausgewertet werden. Das Vorhandensein solcher Sendungen darf auch nicht anderen zur Kenntnis gebracht werden.
4. Durch Ton- oder Fernseh-Rundfunkempfänger darf der Betrieb anderer elektrischer Anlagen nicht gestört werden.
5. Änderungen der Ton- oder Fernseh-Rundfunkempfänger, die die zulässigen Frequenzabstimmbereiche der Empfänger erweitern, gehen über den Umfang dieser Genehmigung hinaus und bedürfen vor ihrer Ausführung einer besonderen Genehmigung der Deutschen Bundespost.

Wer aufgrund dieser Genehmigung einen Ton- oder Fernseh-Rundfunkempfänger betreibt, hat bei einer Änderung der kennzeichnenden Merkmale von Ton- oder Fernseh-Rundfunksendern (insbesondere bei Änderung des Sendeverfahrens oder bei Frequenzwechsel) die ggf. notwendig werdenden Änderungen an dem Rundfunkempfänger auf seine Kosten vornehmen zu lassen.

6. Die Deutsche Bundespost ist berechtigt, Rundfunkempfänger und mit ihnen verbundene Geräte darauf zu prüfen, ob die Auflagen der Genehmigung und die Technischen Vorschriften eingehalten werden.

Den Beauftragten der Deutschen Bundespost ist das Betreten der Grundstücke oder Räume, in denen sich Ton- oder Fernseh-Rundfunkempfänger befinden, zu den verkehrsüblichen Zeiten zu gestatten. Befinden sich die Rundfunkempfänger oder mit ihnen verbundene Geräte nicht im Verfügungsbereich desjenigen, der die Empfänger betreibt, so hat er den Beauftragten der Deutschen Bundespost Zutritt zu diesen Teilen zu ermöglichen.

III.

Bei Funkstörungen, die nicht durch Mängel der Rundfunkempfänger oder der mit ihnen verbundenen Geräte verursacht werden, können die Funkmelddienste der Deutschen Bundespost zur Feststellung der Störung in Anspruch genommen werden.

1. Diese Genehmigung kann allgemein oder durch die örtlich zuständige Oberpostdirektion einem einzelnen Betreiber gegenüber für einen bestimmten Rundfunkempfänger widerrufen werden. Ein Widerruf ist insbesondere zulässig, wenn die unter Abschnitt II aufgeführten Auflagen nicht erfüllt werden.

Anstatt die Genehmigung zu widerrufen, kann die Deutsche Bundespost anordnen, daß bei einem Verstoß gegen eine Auflage ein Ton- oder Fernseh-Rundfunkempfänger außer Betrieb zu setzen ist und erst bei Einhaltung der Auflagen wieder betrieben werden darf.

Die Auflagen dieser Genehmigung können jederzeit ergänzt oder geändert werden.

2. Diese Genehmigung ersetzt die Allgemeine Ton- und Fernseh-Rundfunkgenehmigung vom 11. Dezember 1970, sie gilt ab 1. Juli 1979.

Bonn, den 14. 5. 1979

Der Bundesminister für
das Post- und Fernmeldewesen

Im Auftrag

Haist

*) Siehe Technische Vorschriften für Ton- und Fernseh-Rundfunkempfänger, veröffentlicht im Amtsblatt des Bundesministers für das Post- und Fernmeldewesen.

**) Für ausnahmsweise noch nicht gekennzeichnete, vor dem 1. Juli 1979 errichtete und in Betrieb genommene Ton-Rundfunkempfänger wird die Kennzeichnung nicht verlangt.

ENGLISH

Thank you for purchasing the YAMAHA RX-300/U. In order to ensure proper operation for the best possible performance, please read this manual thoroughly before connecting up your new receiver and turning it on.

IMPORTANT!

Please record the serial number of your unit in the space below.

Model: RX-300/U

Serial No:

PRECAUTIONS

OWNER'S MANUAL

Keep this manual in a safe place for future reference.

LOCATION

Avoid placing your RX-300/U in direct sunlight or close to a source of heat. Also avoid locations in which the device is likely to be subjected to excessive dust, cold or moisture.

VENTILATION

The openings on the cabinet ensure the ventilation of the receiver. If these openings are obstructed, the temperature inside the cabinet will rise rapidly and eventually damage the circuits. Therefore, avoid placing objects against these openings and do not install your receiver in a place where the flow of air through the ventilation openings could be impeded.

HANDLING

● Power cord

When removing the power plug from the wall outlet, always pull directly on the plug. Never yank the cord as this may result in damage to the cord and possibly a short-circuit.

If you do not intend to use this unit for an extended period of time, it is advisable to unplug the power cord.

● Switches and knobs

Avoid applying excessive force to the switches and knobs.

● Relocation

Before moving your receiver, be sure to unplug the power cord and remove all other connecting cables.

IN CASE OF TROUBLE

● Troubleshooting Chart

Consult the Troubleshooting Chart for advice on common operating errors before concluding that your receiver is faulty.

● Servicing

Do not open the cabinet or attempt to make repairs by yourself as this may aggravate the damage and expose you to an electrical shock. For any servicing, refer to your YAMAHA dealer.

● Object and liquid entry

See to it that foreign objects or spilled liquids do not enter into the cabinet. Should this case arise, consult your YAMAHA dealer.

CLEANING

Wipe off dust with a dry soft cloth. To remove dirt or fingermarks, use a damp cloth then dry immediately with a clean cloth. Do not use alcohol, thinners or other chemical solvents since they may damage the finish or remove the panel lettering.

Do not use any aerosol sprays near this unit as these products can easily get into the unit and damage the circuitry.

● Back-Up Power

The back-up power supply will keep the preset stations memorized for about one week if the power supply fails or the set is unplugged. In order to keep the back-up power supply fully charged when the set is not in use, turn the power on more than once a week.

To ensure proper memory setting when first programming the preset stations, the receiver should remain ON for one hour.

SPECIAL INSTRUCTIONS FOR THE BRITISH MODEL

THE WIRES IN THE MAINS LEAD ARE COLOURED IN ACCORDANCE WITH THE FOLLOWING CODE:

Blue: NEUTRAL

Brown: LIVE

As the colours of the wires in the mains lead of this apparatus may not correspond with the coloured markings identifying the terminals in your plug, proceed as follows:

The wire which is coloured BLUE must be connected to the terminal which is marked with the letter N or coloured BLACK. The wire which is coloured BROWN must be connected to the terminal which is marked with the letter L or coloured RED.

VOLTAGE SELECTOR

The voltage selector switch on the rear panel of the RX-300/U must be set for your local voltage BEFORE plugging in the AC mains supply. Voltages are 110/120/220/240 V AC, 50/60 Hz.

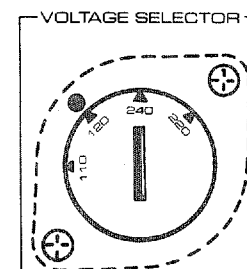

* The General Model is equipped with a voltage selector.

RX-300/U

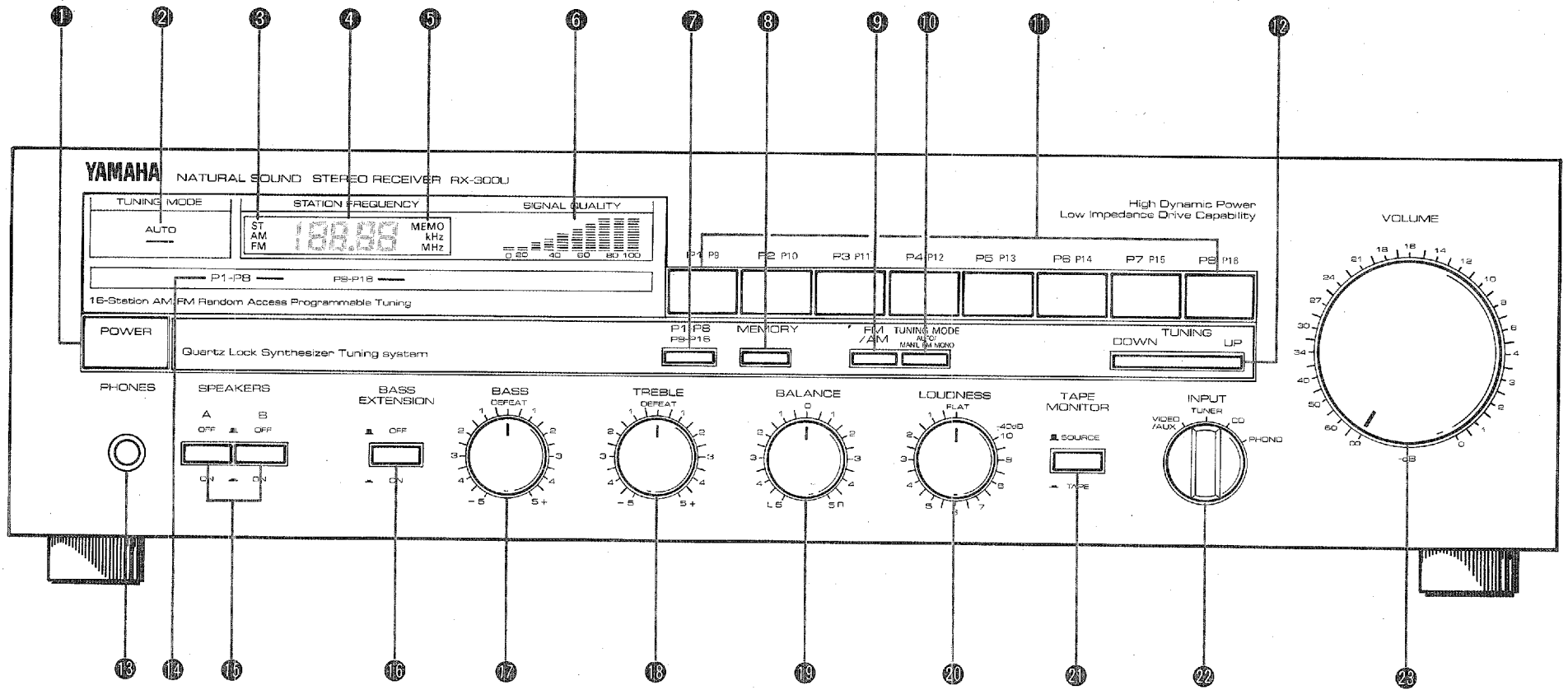

FRONT PANEL DESCRIPTIONS

The Front Panel illustration is provided on page 5.

① POWER SWITCH

Press once to turn power on and again to turn power off.

② TUNING MODE INDICATOR

The Auto LED lights when the TUNING MODE key is set to AUTO and remains off when set to Manual.

③ "ST" INDICATOR

Lights when an FM stereo broadcast with a sufficient signal strength is received.

④ FREQUENCY DISPLAY

A digital display of the frequency recalled by the PRESET keys or tuned in by the TUNING key.

⑤ MEMORY INDICATOR

Pressing the MEMORY key causes this indicator to flicker for a period of approx. 5 seconds, during which, memory presetting may be performed.

⑥ SIGNAL QUALITY INDICATOR

This indicator shows the reception strength of the currently tuned station. When tuning in a station, adjust the antenna height and orientation for maximum signal quality.

⑦ P1-8/P9-16 SELECTOR

This selector performs switching between the 1-8 and 9-16 ranges. Allowing for memory programming and pre-set selection of up to 16 stations.

⑧ MEMORY BUTTON

Press this key to store a station in the programmable memory. When pressed, the Memory Indicator will flicker for approx. 5 seconds. While the indicator is flickering press one of the Preset keys to store the currently displayed frequency into the memory.

⑨ BAND SELECTOR

This selects either AM or FM broadcasts.

⑩ TUNING MODE KEY

Press once to set to Auto and again to set to Manual, the Auto or Manual LED will light up. Auto sets the tuner in the auto-search mode. Pressing the TUNING key automatically tunes in the first station in the direction selected. FM Muting is active in this mode.

Manual/FM Mono sets the tuner in the manual tuning mode, where FM Muting is inactive, allowing extremely weak stations to be received. In this mode even stereo broadcasts will be received in mono. This will improve the reception quality of weak, noisy stereo broadcasts.

⑪ PRESET STATION KEYS

Use these keys, together with the P1-8/P9-16 Selector, to recall an AM/FM station or to store a station in the memory. Any random selection of AM or FM stations can be programmed using these keys.

⑫ TUNING KEY

When the Tuning Mode has been set to AUTO, pressing the DOWN half of the key scans the frequency band downwards until a station is encountered, automatically tuning in the station (Auto-search Tuning). Pushing the key again scans progressively lower frequencies until the next station is found. When the bottom of the band is reached, the frequency is set to the top of the band and the scan continues downward. Pressing the UP half of the key performs this by scanning the band upwards. When the Tuning Mode has been set to MANUAL, pressing the key scans UP or DOWN the band only as long as the key is held. Pressing the Tuning key briefly advances the scan in steps of 100kHz for FM or 10kHz for AM. (The General model is provided with a Frequency Step switch which enables the switching between 100kHz FM/10kHz AM and 50kHz FM/9kHz AM.)

⑬ HEADPHONES JACK

Stereo headphones with a standard plug can be connected to this jack. Speaker switches A and B should be set to the OFF position when listening to the headphones only.

⑭ P1-8/P9-16 RANGE INDICATOR

Pressing the P1-8/P9-16 Selector will cause the Range Indicator to flicker for approx. 5 seconds, following which it will remain steadily lit to indicate the range selected.

⑮ SPEAKERS SWITCHES

As one or two speaker systems can be connected to the RX-300/U these switches allow you to select speaker system A, B or both. When listening to headphones only press both the A and B switches to the OFF position.

⑯ BASS EXTENSION BUTTON

Pressing this button boosts bass response while maintaining overall tonal balance. This is useful to compensate for speakers with weak bass or a listening environment that deadens the bass.

⑰ BASS CONTROL

This knob controls bass response. Turn it clockwise to boost or counterclockwise to attenuate bass response. When this knob is set to the center defeat position a flat response is obtained.

⑱ TREBLE CONTROL

This knob controls treble response. Turn it clockwise to boost or counterclockwise to attenuate treble response. When this knob is set to the center defeat position a flat response is obtained.

⑲ BALANCE CONTROL

This knob is used to adjust the relative volume of the left and right channels, enabling you to compensate for unbalance created by installation locations of the speakers.

⑳ CONTINUOUS LOUDNESS CONTROL

This control provides compensation for the human ear's loss of sensitivity to high and low frequency ranges at low volumes. As the amount of compensation required is determined by the listening level, this control provides the most accurate compensation for any listening level. Set it to the flat position while the volume is set to your normal listening level. Turning it counterclockwise will decrease the volume while retaining the natural balance of low and high frequencies.

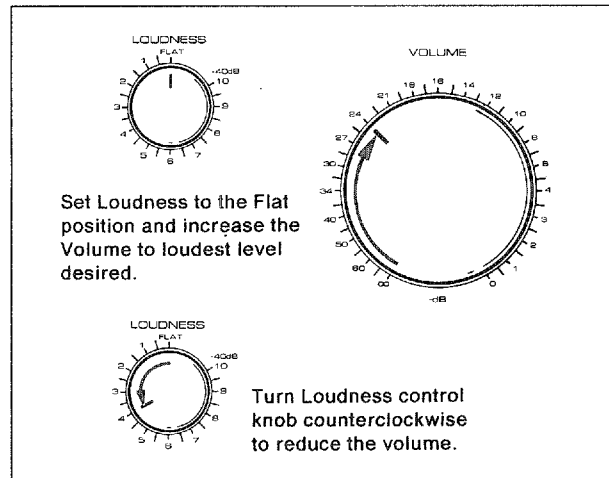

① TAPE MONITOR BUTTON

Press this button to monitor the sound from a tape deck connected to the Tape PB jacks on the rear panel.

② INPUT SELECTOR

Selects the desired input source.

③ VOLUME CONTROL

This controls the sound level. Turning clockwise increases the sound volume while turning counterclockwise decreases it. Set this knob to the minimum level before turning the power on or using the Input Selector to select a different sound source, therefore protecting the speakers from any sudden high level sound.

OPERATIONS

● AUTO TUNING

If signals are strong and there is no interference, quick automatic search tuning is possible.

1. Select the reception band with the BAND SELECTOR.
2. Press the TUNING MODE key to Auto.
3. Use the TUNING key to tune.
Automatic tuning will tune in the first broadcast station frequency with sufficient signal strength.
4. If the station where tuning stops is not the one you want, press the TUNING key once again. Auto tuning may not stop if the station signal is weak. If so, use manual tuning.

● MANUAL TUNING

1. Select the reception band with the BAND SELECTOR.
2. Press the TUNING MODE key to Manual.
3. Use the TUNING key to tune.
The frequency will change rapidly if the TUNING key is held depressed. Release it slightly before reaching the desired frequency, and then press it intermittently until the desired frequency is reached.

● PRESET TUNING

This unit can store a total of 16 stations in memory. The stations can be any combination of AM and FM broadcasts. To preset a station into the memory first tune in the desired station. Press the Memory Key and while the Memory Indicator is flickering depress one of the numbered Preset Keys to store the displayed frequency into the memory. The band is automatically memorized with the frequency. Placing another frequency in the same memory channel automatically cancels the station previously stored in that channel.

To ensure proper programming of preset stations, the receiver should remain on for at least one hour when first setting the preset frequencies.

● LISTENING TO FM BROADCASTS

1. Set the Input Selector to Tuner.
2. Press the Band Selector to FM.
3. Tune in the desired station by following one of the tuning methods described above.

4. When the reception is in stereo the ST Indicator will light, however, for very weak stereo signals and mono stations, it remains off.
5. Adjust your Volume, Loudness, Bass, Treble and Balance controls to provide the desired sound quality.

● LISTENING TO AM BROADCASTS

1. Set the Input Selector to Tuner.
2. Set the Band Selector to AM.
3. Tune in the desired station by following one of the tuning methods described above.
4. Adjust your Volume, Loudness, Bass, Treble and Balance controls to provide the desired sound quality.

● PLAYING BACK CDs, AUX/VIDEO OR RECORDS

1. Set the Input Selector to the desired input.
2. Activate the source component.
3. Adjust your Volume, Loudness, Bass, Treble and Balance controls to provide the desired sound quality.

● PLAYING BACK TAPES

1. Depress the Tape Monitor button.
2. Set the tape deck to PLAY.
3. Adjust your Volume, Loudness, Bass, Treble and Balance controls to provide the desired sound quality.

● RECORDING TAPES

1. Use the Input Selector to select the source to be recorded.
2. Activate the source component then turn the volume up to confirm the input source.
3. Set the tape deck to RECORD.
If your tape deck has three head monitoring capability you can monitor the just recorded signal by setting the Tape Monitor button to TAPE.
4. Adjusting Volume, Loudness, Bass, Treble and Balance controls during recording has no effect on the material being recorded.

CONNECTIONS

The connection diagram is provided on page 58.

- ① Compact disc player
- ② Turntable
- ③ Speaker A
- ④ Speaker B
- ⑤ Tape deck
- ⑥ Video player

● CONNECTING THE AM ANTENNA

In many cases it will be possible to get excellent AM reception with the supplied AM loop antenna. Attach the antenna leads to the GND and AM ANT terminals and clip the antenna onto its bracket, then rotate the antenna to the best reception position. The loop antenna may also be removed and hung on a wall.

If necessary an outdoor antenna may be used for improved AM reception. Connect a 5 ~ 10 meter length of insulated wire to the AM ANT terminal and run it outdoors.

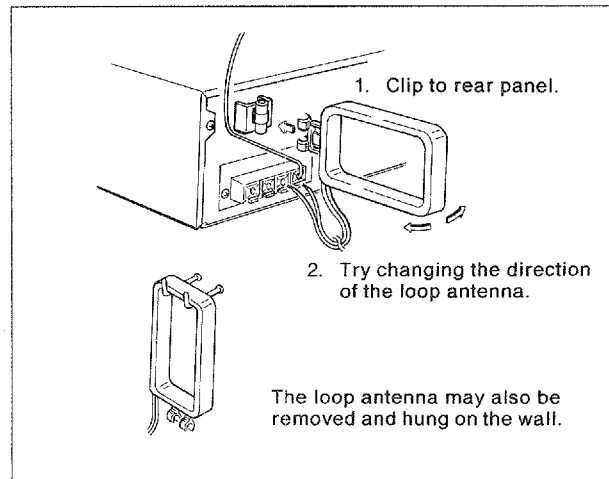

● CONNECTING THE FM ANTENNA

When connecting an FM antenna that is appropriate to local reception conditions, consider the distance from broadcast stations and possible interference from surrounding tall buildings. In cases where there are strong signals from local stations, a portable indoor T-type antenna is usually adequate. Connect the feeder wire to the 300Ω terminal, stretch

the wire out tight and turn to obtain optimum reception. Attach to a suitable support such as a wall. If necessary an outdoor FM antenna may be used for improved FM reception. Either 300Ω flat twin-lead wire or coaxial cable may be used. In locations troubled by electrical interference, coaxial cable is preferable.

Connections for the 300Ω flat twin-lead wire are the same as for the Indoor T-type antenna. For the coaxial cable, connect the center conductor to the left 75Ω terminal and the braid cable to the right 75Ω terminal.

NOTE: Connect either an outdoor FM antenna or an indoor FM T-type antenna but not both.

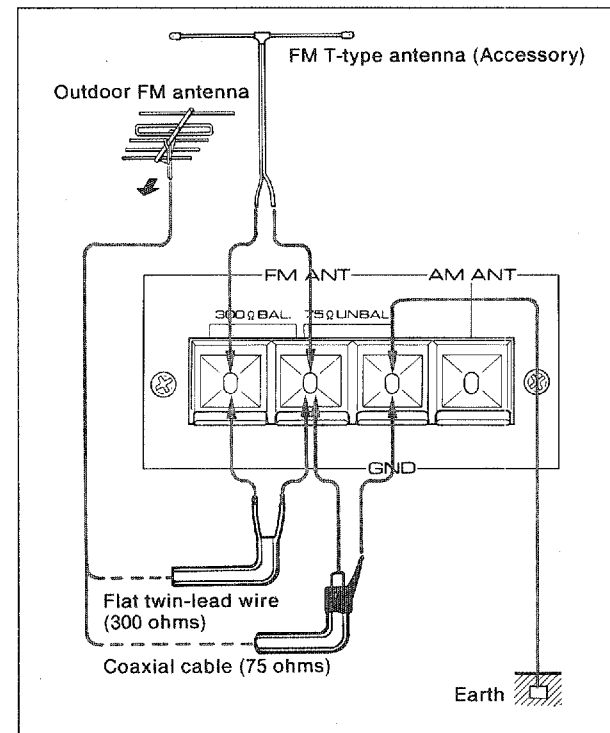

FOR EUROPEAN MODEL

The T-type antenna connection is made using the supplied 300Ω/75Ω adapter plug. Loosen the screws of the supplied plug, insert the ends of the feeder wires between the screws and the underlying metal plates, then tighten the screws.

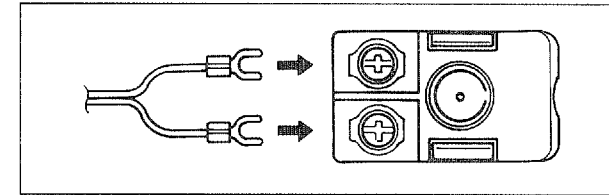

For the outdoor FM antenna, connection is made using the supplied 75Ω/300Ω adapter plug. For 300Ω flat twin-lead wire follow the procedure outlined for the T-type antenna. For coaxial cable, prepare the cable as shown below.

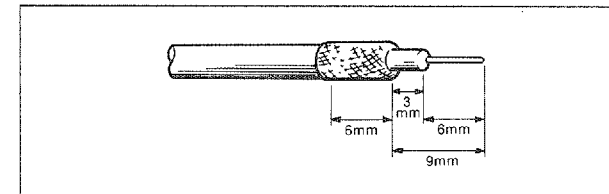

Connect the processed coaxial cable to the 300Ω/75Ω adapter as shown below. The collar indicated in the diagram below must be removed and attached to the pole on the inside of the adapter cover. (See note inside adapter cover.)

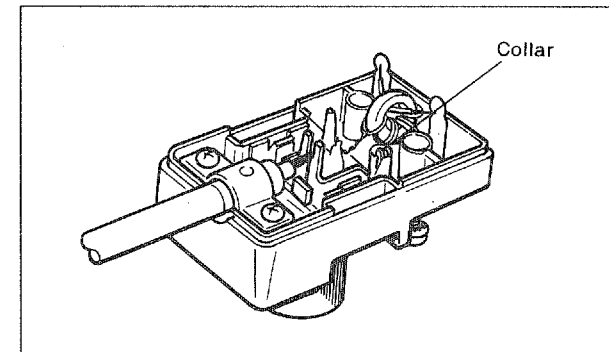

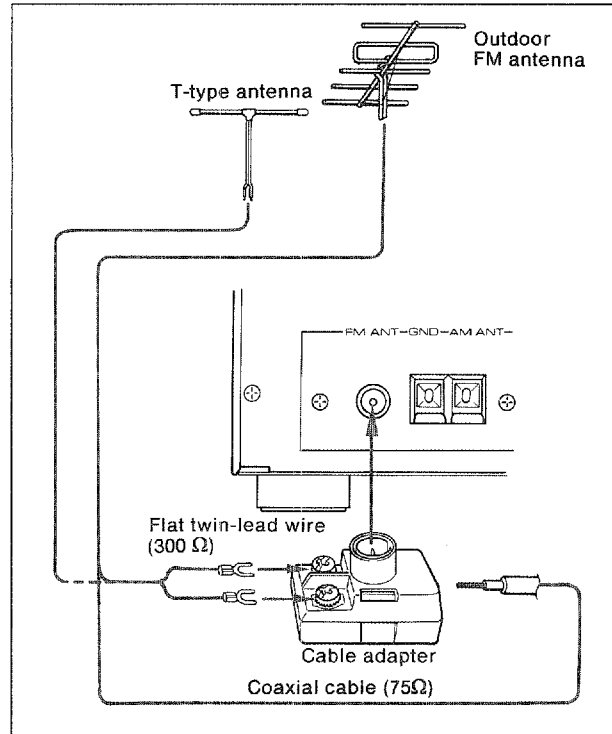

● **CONNECTING THE SPEAKERS**

Connect the cords for the left speakers to the L terminals and connect the right speaker cords to the R terminals. Ensure that the polarity (+ and -) markings are observed. Be sure to do this consistently between components. If the polarity is reversed at either speaker the sound will be unnatural and lack bass. Speaker cords should be cut as short as possible. Avoid coiling the wire on the floor or bundling it up with cords from other system components.

Strip about 10mm (0.39in) of insulating material from the ends of the speaker wires and twist the exposed strands of each end. Push in on the terminal lever, insert the exposed wire and then pull the lever forward to lock the wire into position.

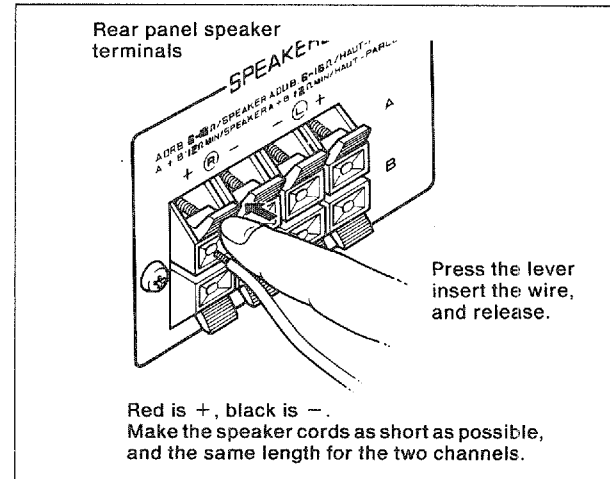

● **CONNECTING A TURNTABLE**

Connect the output cords of the turntable to the PHONO jacks and connect the ground wire to the GND terminal. Normally connecting the ground wire produces minimum hum but in some cases better results are obtained with the ground wire disconnected. The turntable component and its output cords should be positioned well away from sources of hum such as power cords or power transformers of other system components.

● **CONNECTING A TAPE DECK**

Connect the cords from the tape deck's Line In jacks to the Rec Out jacks, ensuring that the left and right are not reversed. Then connect the cords from the tape deck's Line Out jacks to the Tape PB jacks.

● **CONNECTING TO THE CD AND VIDEO/AUX JACKS**

Connect your CD component to the CD terminals and video component to the VIDEO/AUX terminals. Please note that a turntable can not be connected to these jacks as they do not provide the necessary RIAA equalization.

● **AC OUTLETS (General and Canadian models)**

For added convenience the RX-300/U provides 2 AC outlets. One "switched" outlet (the power to this outlet is controlled by this unit's power switch) and one "unswitched" outlet (the power to this is independent of this unit's power switch). Be sure not to connect appliances totaling more than 200 watts to

the unswitched outlet or more than 100 watts to the switched outlet.

● **GROUNDING**

For added safety and reduced interference, grounding is recommended. Be sure not to connect ground wire to a water or gas pipe as this may result in electric shock or fire.

● **ABOUT THE FREQUENCY STEP SWITCH (General Model)**

Areas other than the United States, Canada and Europe, because interstation frequency spacing is different in different areas, please set rear panel FREQUENCY STEP switch to agree with the station spacing in your area (50 kHz FM/9 kHz AM or 100 kHz FM/10 kHz AM).

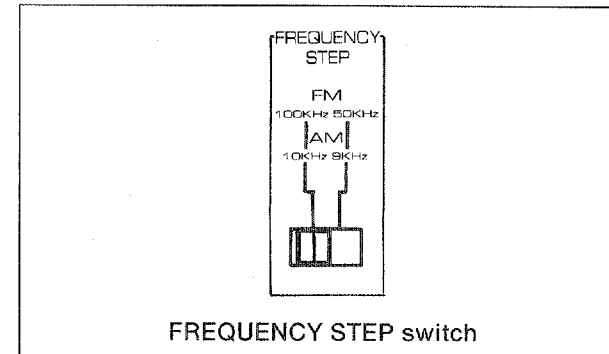

MULTIPATH INTERFERENCE

Multipath is an effect similar to television ghosting; it distorts the received signal and also causes poor stereo separation and noise. As shown below, radio waves which travel directly from the transmitter to the receiving antenna are mixed with waves which reflect off nearby objects such as buildings. Because the path taken by the reflected waves is longer than the direct path, the time required for the waves to arrive at the antenna is also longer. The mixing of the directly received signal and the delayed signal noticeably degrades reception quality. Multipath interference can be greatly reduced by the use of a high-quality directional antenna correctly oriented.

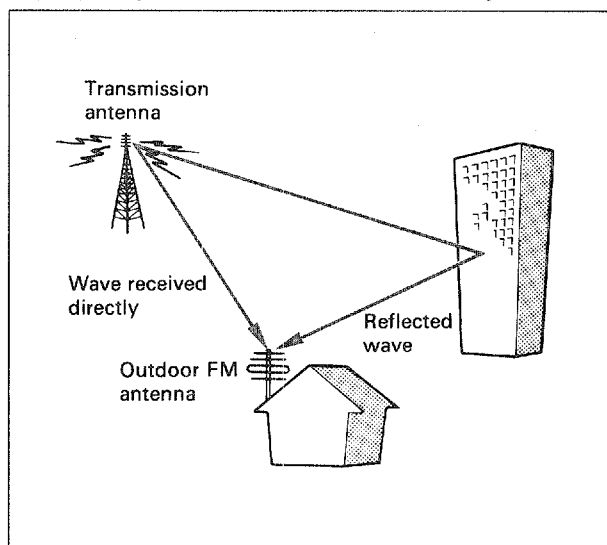

PREVIOUS-STATION MEMORY

● If power is turned off while a station is tuned in, the same station will be tuned in automatically when power is turned on again. Even if the power cord is pulled out rather than the power key being turned off, the effect is the same.

● When the reception band is changed from FM to AM, the last AM station listened to will automatically be tuned in again. In the same way, when reception band is changed from AM to FM, the last FM station will be tuned in again.

* If the power is turned off or the Band selector is pressed while auto-search tuning is in progress, next time the power is turned on or the Band selector is pressed no station may be tuned in even though the frequency display is lit.

General Model

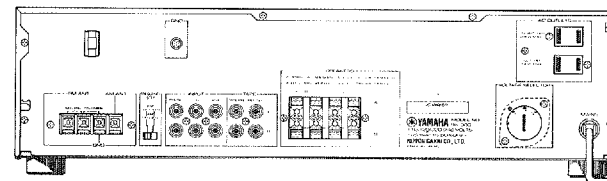

British and Australian Model

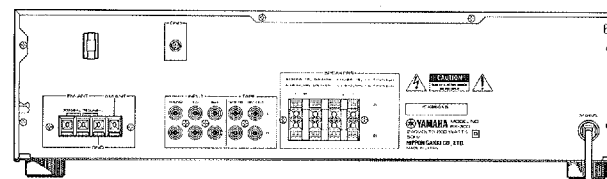

European Model

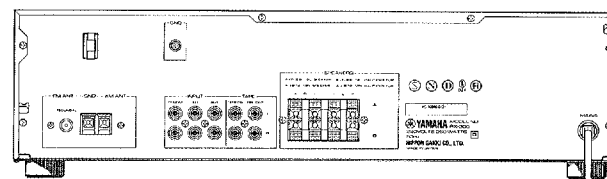

TROUBLESHOOTING

Before assuming that your unit is faulty, please check the following troubleshooting list which details the corrective action you can take yourself without having to call a service engineer. If you have any doubts or questions, contact your nearest Yamaha dealer.

	FAULT	CAUSE	REMEDY
AUDIO	Power is not supplied even though the POWER switch is turned on .	The power cord is not plugged in.	Plug in the power cord.
	There is no sound even when the Input Selector is pressed.	The Tape Monitor Switch is ON.	Push Tape Monitor Switch to SOURCE position.
		The speaker connections are not secure.	Set them correctly.
		The input cords are not connected securely.	Plug them in securely.
	There is no sound from one speaker.	The speaker connections are not secure.	Secure the connections.
		The BALANCE control is set all the way to the left or right.	Adjust the BALANCE control correctly.
	There is a lack of bass and no ambience.	The + and - cords have been reversed at the receiver or the speakers.	Connect the speaker cords in the correct phase (+ and -).
	There is a humming sound when playing records.	The input cords are not connected securely.	Plug the input cords in securely.
		The turntable's ground wire is not connected.	Connect the ground wire.
	There is a howling sound when playing records at high volume.	The turntable and the speakers are too close together or the turntable is not mounted on a firm surface.	Change the location of the turntable or the speakers.
FM	Crackling sounds from time to time (especially in weak signal areas).	Ignition noise from vehicles.	The FM antenna should be put up as high as possible, away from the road, and a coaxial cable used.
		Noise from thermostats and other electrical equipment.	Attach a noise suppressor to the equipment causing the noise.
	FM stereo reception is noisy.	The transmitter is far away or the antenna input is poor.	Check the antenna connections.
			Try using a multiple element FM antenna.
	The ST indicator flickers on and off and reception is noisy.	Insufficient antenna input.	Use an antenna appropriate for the reception conditions in your area.
		Not tuned correctly.	Tune again.
	There is distortion and clear reception cannot be obtained even with a good FM antenna.	There is multipath interference.	Adjust antenna placement to eliminate multipath interference.
No stereo effect even with a stereo broadcast.	The TUNING MODE selector is set to MAN'L FM MONO.	Set the selector properly.	

	FAULT	CAUSE	REMEDY
FM	A desired station cannot be tuned in with Auto Tuning.	The station is too weak.	Reorient your antenna or try using a high-quality directional antenna.
	Previously preset stations can no longer be tuned in.	The receiver has been unplugged for a long period.	Repeat the preset procedure.
		When setting presets the unit must remain on for at least one hour for preset frequencies to be properly memorized.	When setting presets leave unit on for approx. one hour.
AM	Insufficient sensitivity in AM broadcasts.	Weak signal or loose antenna connections.	Tighten the AM loop antenna connections and rotate it for best reception.
			Use an outdoor antenna.
	There are continuous crackling and hissing noises.	These noises result from lightning, fluorescent lamps, motors, thermostats and other electrical equipment.	Use an outdoor antenna and a ground wire.
	There are buzzing and whining noises.	A TV set is being used nearby.	Move the TV set a distance away.

SPECIFICATIONS

● AUDIO SECTION

Minimum RMS Output Power Per Channel	
20Hz ~ 20kHz 0.04% THD 8Ω	33W
(Canadian and General models)	37W
0.06% THD 6Ω	39W
(Canadian and General models)	40W
Dynamic Power Per Channel (by IHF Dynamic Headroom measuring method)	
8Ω/6Ω/4Ω	54W/63W/75W
DIN Standard Output Power Per Channel	
1kHz 1% THD 4Ω	47W
IEC Power	
1kHz 0.04% THD 8Ω/6Ω	42W/44W
Power Band Width	
0.1% THD 18.5W 8Ω	10Hz ~ 40kHz
Damping Factor	
1kHz 8Ω	> 50
Input Sensitivity/Impedance (Canadian and General models)	
Phono MM	2.5mV/47kΩ
CD/TUNER/VIDEO·AUX/TAPE	150mV/50kΩ
Input Sensitivity (NEW IHF, Canadian and General models)	
Phono MM	0.42mV
CD/TUNER/VIDEO·AUX/TAPE	25mV
Maximum Input Signal	
1kHz Phono MM	120mV
Output Level/Impedance	
REC OUT	150mV/100Ω
Headphone Jack Rated Output/Impedance	
0.04% THD RL = 235Ω	0.55V/8Ω
Frequency Response	
20Hz ~ 20kHz CD/TUNER/VIDEO·AUX/TAPE	± 0.5dB
RIAA Equalization Deviation	
Phono MM	± 0.5dB
Total Harmonic Distortion 20Hz ~ 20kHz	
Phono MM to REC OUT 3V	0.01%
CD/TUNER/VIDEO·AUX/TAPE to SP Out 18.5W/8Ω	0.02%
Intermodulation Distortion	
CD/TUNER/VIDEO·AUX/TAPE Rated Output/8Ω	0.04%
Signal to Noise Ratio (IHF-A-Network)	
Phono MM (5mV Input Shorted)	82dB
(Canadian and General models)	88dB
CD/TUNER/VIDEO·AUX/TAPE (Shorted)	103dB
Channel Separation Vol. - 30dB	
Phono MC, MM Input Shorted 1kHz	55dB
CD/TUNER/VIDEO·AUX/TAPE Input 5.1kΩ Terminated 1kHz	52dB

Tone Control Characteristics

BASS boost/cut	± 10dB (50Hz)
turnover frequency	350Hz
TREBLE boost/cut	± 10dB (20kHz)
turnover frequency	3.5kHz

Filter Characteristics

Bass Extension	60Hz 8dB
----------------	----------

Continuous Loudness Control (Level related equalization)

Attenuation	- 40dB
-------------	--------

● FM SECTION

Tuning Range

European, General, Australian and British models	87.5 ~ 108.0MHz
Canadian model	87.5 ~ 107.9MHz

50dB Quieting Sensitivity (IHF)

75Ω mono	1.55μV (15.1dBf)
stereo	21μV (37.7dBf)

Usable Sensitivity

75Ω 1kHz 100% MOD (30dB S/N Quieting)	0.8μV (9.3dBf)
---------------------------------------	----------------

Usable Sensitivity (DIN)

75Ω mono (S/N 26dB)	1.4μV
stereo (S/N 46dB)	30.0μV

Image Response Ratio

50dB

(European model) 90dB

IF Response Ratio

75dB

(European model) 85dB

Spurious Response Ratio

70dB

AM Suppression Ratio

55dB

Capture Ratio

1.5dB

Alternate Channel Selectivity

85dB

Selectivity (two signals)

40kHz Dev ± 300kHz	50dB
--------------------	------

Signal to Noise Ratio (IHF)

mono	81dB
stereo	76dB

Signal to Noise Ratio (DIN-Un Weighted)

mono	76dB
stereo	70dB

Harmonic Distortion (40kHz Dev)

mono 1kHz	0.1%
stereo 1kHz	0.2%

Stereo Separation

1kHz	50dB
------	------

Frequency Response

30Hz to 15kHz 0 ± 0.5dB

● **AM SECTION**

Tuning Range

European, General, Australian and British models 531 ~ 1611kHz

Canadian and General models 530 ~ 1610kHz

Usable Sensitivity 250µV/m

Selectivity 32dB

Signal to Noise Ratio 50dB

Image Response Ratio 40dB

Spurious Response Ratio 50dB

Harmonic Distortion 0.3%

● **GENERAL SECTION**

Power Supply

British and Australian models AC 240V 50Hz

European model AC 220V 50Hz

General model AC 110/120/220/240V 60/50Hz

Power Consumption

British and Australian models 260W

European model 260W

Canadian and General models 145W

Dimensions (W x H x D) 435 x 126 x 288.5mm

(17.1 x 5.0 x 11.4in)

Weight 5.2kg

(11.5lbs.)

* *Specifications subject to change without notice.*

SINCE 1887  **YAMAHA**
NIPPON GAKKI CO., LTD. HAMAMATSU, JAPAN