



MIXING CONSOLE

# IM8-40/IM8-32/IM8-24

Owner's Manual  
Bedienungsanleitung  
Mode d'emploi  
Manual de instrucciones  
Manuale di istruzioni  
Руководство пользователя  
使用说明书  
取扱説明書



English

Deutsch

Français

Español

Italiano

Русский

中文

日本語

EN  
DE  
FR  
ES  
IT  
RU  
ZH  
JA

## FCC INFORMATION (U.S.A.)

### 1. IMPORTANT NOTICE: DO NOT MODIFY THIS UNIT!

This product, when installed as indicated in the instructions contained in this manual, meets FCC requirements. Modifications not expressly approved by Yamaha may void your authority, granted by the FCC, to use the product.

**2. IMPORTANT:** When connecting this product to accessories and/or another product use only high quality shielded cables. Cable/s supplied with this product MUST be used. Follow all installation instructions. Failure to follow instructions could void your FCC authorization to use this product in the USA.

**3. NOTE:** This product has been tested and found to comply with the requirements listed in FCC Regulations, Part 15 for Class "B" digital devices. Compliance with these requirements provides a reasonable level of assurance that your use of this product in a residential environment will not result in harmful interference with other electronic devices. This equipment generates/uses radio frequencies and, if not installed and used according to the instructions found in the users manual, may cause interference harmful to the operation of other electronic devices. Compliance with FCC regulations does not guarantee

that interference will not occur in all installations. If this product is found to be the source of interference, which can be determined by turning the unit "OFF" and "ON", please try to eliminate the problem by using one of the following measures:

Relocate either this product or the device that is being affected by the interference.

Utilize power outlets that are on different branch (circuit breaker or fuse) circuits or install AC line filter/s.

In the case of radio or TV interference, relocate/reorient the antenna. If the antenna lead-in is 300 ohm ribbon lead, change the lead-in to co-axial type cable.

If these corrective measures do not produce satisfactory results, please contact the local retailer authorized to distribute this type of product. If you can not locate the appropriate retailer, please contact Yamaha Corporation of America, Electronic Service Division, 6600 Orangethorpe Ave, Buena Park, CA90620

The above statements apply ONLY to those products distributed by Yamaha Corporation of America or its subsidiaries.

\* This applies only to products distributed by YAMAHA CORPORATION OF AMERICA.

(class B)

### COMPLIANCE INFORMATION STATEMENT (DECLARATION OF CONFORMITY PROCEDURE)

Responsible Party : Yamaha Corporation of America

Address : 6600 Orangethorpe Ave., Buena Park, Calif. 90620

Telephone : 714-522-9011

Type of Equipment : MIXING CONSOLE

Model Name : IM8-40/IM8-32/IM8-24

This device complies with Part 15 of the FCC Rules.

Operation is subject to the following two conditions:

- 1) this device may not cause harmful interference, and
- 2) this device must accept any interference received including interference that may cause undesired operation.

See user manual instructions if interference to radio reception is suspected.

\* This applies only to products distributed by  
YAMAHA CORPORATION OF AMERICA.

(FCC DoC)

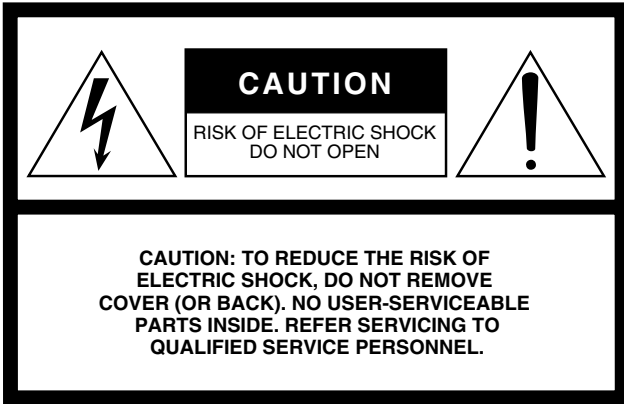

## Explanation of Graphical Symbols

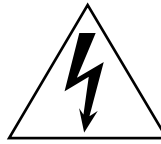

The lightning flash with arrowhead symbol within an equilateral triangle is intended to alert the user to the presence of uninsulated “dangerous voltage” within the product’s enclosure that may be of sufficient magnitude to constitute a risk of electric shock to persons.



The exclamation point within an equilateral triangle is intended to alert the user to the presence of important operating and maintenance (servicing) instructions in the literature accompanying the product.

The above warning is located on the rear of the unit.

# IMPORTANT SAFETY INSTRUCTIONS

- 1 Read these instructions.
- 2 Keep these instructions.
- 3 Heed all warnings.
- 4 Follow all instructions.
- 5 Do not use this apparatus near water.
- 6 Clean only with dry cloth.
- 7 Do not block any ventilation openings. Install in accordance with the manufacturer’s instructions.
- 8 Do not install near any heat sources such as radiators, heat registers, stoves, or other apparatus (including amplifiers) that produce heat.
- 9 Do not defeat the safety purpose of the polarized or grounding-type plug. A polarized plug has two blades with one wider than the other. A grounding type plug has two blades and a third grounding prong. The wide blade or the third prong are provided for your safety. If the provided plug does not fit into your outlet, consult an electrician for replacement of the obsolete outlet.
- 10 Protect the power cord from being walked on or pinched particularly at plugs, convenience receptacles, and the point where they exit from the apparatus.
- 11 Only use attachments/accessories specified by the manufacturer.
- 12 Use only with the cart, stand, tripod, bracket, or table specified by the manufacturer, or sold with the apparatus. When a cart is used, use caution when moving the cart/apparatus combination to avoid injury from tip-over.
- 13 Unplug this apparatus during lightning storms or when unused for long periods of time.
- 14 Refer all servicing to qualified service personnel. Servicing is required when the apparatus has been damaged in any way, such as power-supply cord or plug is damaged, liquid has been spilled or objects have fallen into the apparatus, the apparatus has been exposed to rain or moisture, does not operate normally, or has been dropped.



### WARNING

TO REDUCE THE RISK OF FIRE OR ELECTRIC SHOCK, DO NOT EXPOSE THIS APPARATUS TO RAIN OR MOISTURE.

(UL60065\_03)

# PRECAUTIONS

## PLEASE READ CAREFULLY BEFORE PROCEEDING

\* Please keep this manual in a safe place for future reference.



### WARNING

Always follow the basic precautions listed below to avoid the possibility of serious injury or even death from electrical shock, short-circuiting, damages, fire or other hazards. These precautions include, but are not limited to, the following:

#### Power supply/Power cord

- Only use the voltage specified as correct for the device. The required voltage is printed on the name plate of the device.
- Use only the specified power supply (PW8 or an equivalent recommended by Yamaha).
- Do not place the power cord near heat sources such as heaters or radiators, and do not excessively bend or otherwise damage the cord, place heavy objects on it, or place it in a position where anyone could walk on, trip over, or roll anything over it.

#### Do not open

- Do not open the device or attempt to disassemble the internal parts or modify them in any way. The device contains no user-serviceable parts. If it should appear to be malfunctioning, discontinue use immediately and have it inspected by qualified Yamaha service personnel.

#### Water warning

- Do not expose the device to rain, use it near water or in damp or wet conditions, or place containers on it containing liquids which might spill into any openings. If any liquid such as water seeps into the device, turn off the power immediately and unplug the power cord from the AC outlet. Then have the device inspected by qualified Yamaha service personnel.
- Never insert or remove an electric plug with wet hands.

#### If you notice any abnormality

- If the power cord or plug becomes frayed or damaged, or if there is a sudden loss of sound during use of the device, or if any unusual smells or smoke should appear to be caused by it, immediately turn off the power switch, disconnect the electric plug from the outlet, and have the device inspected by qualified Yamaha service personnel.
- If this device or power supply should be dropped or damaged, immediately turn off the power switch, disconnect the electric plug from the outlet, and have the device inspected by qualified Yamaha service personnel.



### CAUTION

Always follow the basic precautions listed below to avoid the possibility of physical injury to you or others, or damage to the device or other property. These precautions include, but are not limited to, the following:

#### Power supply/Power cord

- Remove the electric plug from the outlet when the device is not to be used for extended periods of time, or during electrical storms.
- When removing the electric plug from the device or an outlet, always hold the plug itself and not the cord. Pulling by the cord can damage it.

#### Location

- When transporting or moving the device, always use two or more people. Attempting to lift the device by yourself may damage your back, result in other injury, or cause damage to the device itself.
- Before moving the device, remove all connected cables.
- Avoid setting all equalizer controls and faders to their maximum. Depending on the condition of the connected devices, doing so may cause feedback and may damage the speakers.
- Do not expose the device to excessive dust or vibrations, or extreme cold or heat (such as in direct sunlight, near a heater, or in a car during the day) to prevent the possibility of panel disfiguration or damage to the internal components.
- Do not place the device in an unstable position where it might accidentally fall over.
- Do not use the device in the vicinity of a TV, radio, stereo equipment, mobile phone, or other electric devices. Doing so may result in noise, both in the device itself and in the TV or radio next to it.

#### Connections

- Before connecting the device to other devices, turn off the power for all devices. Before turning the power on or off for all devices, set all volume levels to minimum.

#### Handling caution

- When turning on the AC power in your audio system, always turn on the power amplifier LAST, to avoid speaker damage. When turning the power off, the power amplifier should be turned off FIRST for the same reason.
- Do not insert your fingers or hands in any gaps or openings on the device.
- Avoid inserting or dropping foreign objects (paper, plastic, metal, etc.) into any gaps or openings on the device. If this happens, turn off the power immediately and unplug the power cord from the AC outlet. Then have the device inspected by qualified Yamaha service personnel.
- Do not apply oil, grease, or contact cleaner to the faders. Doing so may cause problems with electrical contact or fader motion.
- Do not use the headphones or speakers for a long period of time at a high or uncomfortable volume level, since this can cause permanent hearing loss. If you experience any hearing loss or ringing in the ears, consult a physician.
- Do not rest your weight on the device or place heavy objects on it, and avoid use excessive force on the buttons, switches or connectors.

XLR-type connectors are wired as follows (IEC60268 standard): pin 1: ground, pin 2: hot (+), and pin 3: cold (-).  
 Insert TRS phone jacks are wired as follows: sleeve: ground, tip: send, and ring: return.

Yamaha cannot be held responsible for damage caused by improper use or modifications to the device, or data that is lost or destroyed.

Always turn the power off when the device is not in use.

The performance of components with moving contacts, such as switches, volume controls, and connectors, deteriorates over time. Consult qualified Yamaha service personnel about replacing defective components.

## SPECIAL NOTICES

- This manual is the exclusive copyright of Yamaha Corporation.
- The software included in the accessory disk and the copyrights thereof are under exclusive ownership by Steinberg Media Technologies GmbH.
- Use of the software and this manual is governed by the license agreement which the purchaser fully agrees to upon breaking the seal of the software packaging. (Please read carefully the Software Licensing Agreement at the end of this manual before installing the application.)
- Copying of the software or reproduction of this manual in whole or in part by any means is expressly forbidden without the written consent of the manufacturer.
- Yamaha makes no representations or warranties with regard to the use of the software and documentation and cannot be held responsible for the results of the use of this manual and the software.
- This disk containing the software is not meant for use with an audio/visual system (CD player, DVD player, etc.). Do not attempt to use the disk on equipment other than a computer.
- Future upgrades of application and system software and any changes in specifications and functions will be announced separately.

The illustrations and LCD screens as shown in this manual are for instructional purposes only, and may appear somewhat different from those on your instrument.

This product incorporates and bundles computer programs and contents in which Yamaha owns copyrights or with respect to which it has license to use others' copyrights. Such copyrighted materials include, without limitation, all computer software, style files, MIDI files, WAVE data, musical scores and sound recordings. Any unauthorized use of such programs and contents outside of personal use is not permitted under relevant laws. Any violation of copyright has legal consequences. DON'T MAKE, DISTRIBUTE OR USE ILLEGAL COPIES.

Copying of the commercially available musical data including but not limited to MIDI data and/or audio data is strictly prohibited except for your personal use.

- Windows is a registered trademark of Microsoft® Corporation in the United States and other countries.
- The company names and product names in this manual are the trademarks or registered trademarks of their respective companies.

## European models

Purchaser/User Information specified in EN55103-1 and EN55103-2.

Conforms to Environments: E1, E2, E3, E4

Specifications and descriptions in this owner's manual are for information purposes only.

Yamaha Corp. reserves the right to change or modify products of specifications at any time without prior notice. Since specifications, equipment or options may not be the same in every locale, please check with your Yamaha dealer.

# Introduction

Thank you for your purchase of the Yamaha IM8 mixing console. Please read through this manual carefully before beginning use, so that you will be able to take full advantage of your mixer's superlative features and enjoy trouble-free operation for years to come. After you've read the manual, keep it safe for future reference when needed.

## Features

- **Input channels**

The console provides 40 monaural input channels (the IM8-32 has 32 channels, and the IM8-24 has 24 channels) that can accommodate mic through line-level devices, as well as four stereo inputs that can accommodate line-level devices.

- **Compressors**

A compressor is provided on every monaural channel. Using just a single knob, you can compress the peaks of the input signal from a source such as a microphone or acoustic instrument (e.g., guitar), raising the overall volume without allowing the sound to distort.

- **AUX SEND faders**

Faders are provided on the AUX sends, allowing you to use them not only for the main mix but also to create individual mixes for monitoring.

## Accessories

- **Owner's Manual (this book)**
- **Power supply cable**
- **Cubase AI 4 DVD-ROM**
- **USB cable**

## Table of Contents

<b>Introduction .....</b>	<b>6</b>
Features .....	6
Accessories .....	6
System Requirements .....	7
Differences between the IM8-40/32/24 mixers .....	7
<b>Controls and Functions .....</b>	<b>8</b>
Channel Control Section .....	8
Master Control Section .....	12
STEREO AUX RETURN Section .....	13
2TR IN/USB Section .....	13
REC OUT/USB Section .....	14
MATRIX OUT Section .....	14
DC POWER INPUT Section .....	15
MUTE MASTER Section .....	15
TALKBACK Section .....	15
AUX SEND Section .....	16
GROUP OUT Section .....	16
STEREO MASTER Section .....	17
MONITOR Section .....	18
MONO Section .....	19
LAMP Connector .....	19
<b>Troubleshooting .....</b>	<b>20</b>
<b>About the accessory disk .....</b>	<b>21</b>
<b>Specifications .....</b>	<b>166</b>
Electrical Specifications .....	166
General Specifications .....	167
Analog Input Specifications .....	167
Analog Output Specifications .....	168
Digital Input/Output Specifications .....	168
Jack List .....	169
Dimensional Diagram .....	170
<b>Track Sheet .....</b>	<b>172</b>
<b>Block Diagram and Level Diagram ..</b>	<b>174</b>

## System Requirements

### ■ Computer System Requirements

For latest information about the minimum system requirements etc., check the web site below.  
<<http://www.yamahaproaudio.com/>>

### ■ Cubase AI 4 System Requirements

For information about the minimum system requirements and latest information on Cubase AI, check the web site below.  
<<http://www.yamahasyth.com/>>

## Differences between the IM8-40/32/24 mixers

The IM8 mixer is available in three models (IM8-40, IM8-32, IM8-24) which differ as follows.

- **Number of monaural input channels**

The IM8-40 provides 40 monaural input channels, the IM8-32 provides 32, and the IM8-24 provides 24. The remaining channels (stereo input channels, 2TR IN, etc.) are the same for all models.

- **Number of LAMP connectors**

The IM8-40 provides three LAMP connectors to which you can connect separately sold gooseneck lamps (e.g., Yamaha LA5000), while the IM8-32 and IM8-24 provide two such connectors.

# Controls and Functions

## Channel Control Section

### • Rear Panel

Monaural channels

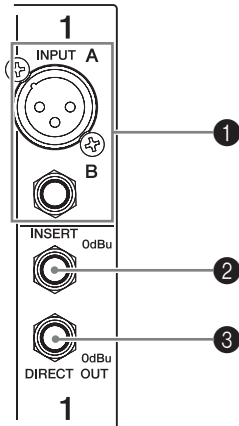

Stereo channels

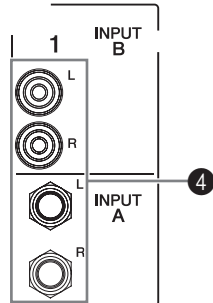

Turn off the Yamaha PW8 power supply before you connect or disconnect any cables to or from the console.

#### 1 INPUT Jack (monaural)

These monaural input jacks are used to connect microphones or musical instruments. Each input channel features two types of jacks (INPUT A and INPUT B).

##### • INPUT A Jack

These are balanced XLR-3-31 type input jacks (1: Ground; 2: Hot; 3: Cold).

##### • INPUT B Jack

These are TRS phone-jack type balanced inputs. (T: Hot; R; Cold; S: Ground)  
You can connect either balanced or unbalanced phone plugs to these jacks.

#### **NOTE**

- Only one type of jack can be used at a time on a single channel.

#### 2 INSERT Jack

These jacks are located between the compressor and equalizer of the corresponding monaural input channel. The INSERT jacks are ideal for connecting devices such as graphic equalizers or noise filters into the corresponding channels. The INSERT jacks are TRS (tip, ring, sleeve) phone jacks that carry both the send and return signal (tip = send/out; ring = return/in; sleeve = ground).

#### **NOTE**

- Patching external devices via an INSERT jack requires a special insert cable such as illustrated below (insert cable sold separately).

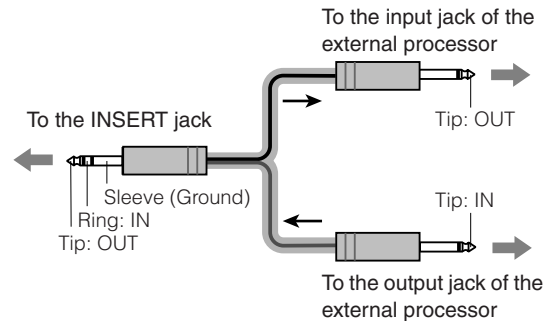

#### 3 DIRECT OUT Jack

These are impedance balanced (page 19) phone-jack type outputs. They output the signal that has passed through the compressor.

#### **NOTE**

- If necessary, the signal that is output from the DIRECT OUT jack can be changed to the signal immediately before the channel fader (pre-fader) or the signal after the channel fader (post-fader) by changing an internal jumper. A fee will be charged for this modification. For details, contact to your Yamaha dealer listed at the end of this manual.

#### 4 INPUT Jacks (stereo)

These are stereo input jacks that connect line-level instruments, such as a synthesizer. Each input channel features two types of jacks (INPUT A and INPUT B).

##### • INPUT A Jacks

These are unbalanced phone-jack stereo line inputs.

##### • INPUT B Jacks

These are unbalanced stereo RCA pin-jack line inputs.

#### **NOTE**

- Only one type of jack can be used at a time on a single channel.



• Top Panel

Monaural channels      Stereo channels

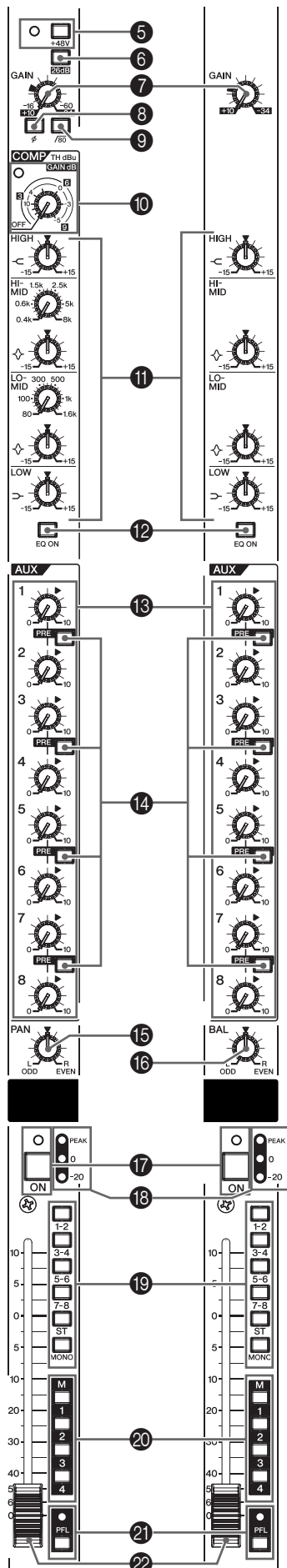

5 +48V Switch/Indicator

This switch toggles phantom power on and off for a monaural channel. When the switch is turned on, the +48V indicator will light, and DC +48V phantom power will be supplied to Pin 2 and 3 of the corresponding XLR-type INPUT A jacks. Turn this switch on when using a phantom-powered condenser microphone.



- Be sure to leave this switch off if you do not need phantom power.
- When turning phantom power on, be sure that only a condenser microphone is connected to the INPUT A jack of the monaural channel. Other devices may be damaged if connected to phantom power. This precaution does not apply to balanced dynamic microphones, however, as these will not be affected by phantom power.
- To avoid damage to speakers, be sure to turn off amplifiers (or powered speakers) before turning this switch on or off. It's also a good idea to turn the mixer's output controls - STEREO OUT master fader and GROUP OUT faders - all the way down. If you omit this precaution, you may damage your hearing or your equipment.

6 26 dB (PAD) Switch

When this switch is turned on, the input signal from the INPUT jack of the monaural channel is attenuated by 26 dB. Turn the switch off (  ) if you've connected a microphone or other device with a low input level to the channel. Turn it on (  ) if you've connected a line-level device.

7 GAIN Control

This adjusts the sensitivity of the input signal from the INPUT jack. Monaural channels have a 26 dB switch (6) that lets you change the range of this control. The adjustable sensitivity range is as follows.

• Monaural channel

26 dB switch	Range
ON	-34dB to +10dB
OFF	-60dB to -16dB

• Stereo channel

-34dB to +10dB

8 ∅ (Phase) Switch

Turning this switch on will invert the phase of the input signal. Turn this switch on if you need to mix a phase-reversed signal.

**NOTE**

- If you try to mix a phase-reversed signal, the signals will interfere with each other, resulting in degraded sound quality.

9 /80 (High Pass Filter) Switch

This switch toggles the HPF on or off.

Turning this switch ON will apply a high-pass filter that attenuates the signal below 80 Hz by a slope of 12 dB/octave.

**10 COMP Control/Indicator**

Adjusts the amount of compression applied to the channel. As the COMP knob is turned to the right the compression ratio increases while the output gain is automatically adjusted accordingly. The result is smoother, more even dynamics because louder signals are attenuated while the overall level is boosted. The COMP indicator will light when the compressor operates.

**NOTE**

- Avoid setting the compression too high, as the higher average output level that results may lead to feedback.

**11 EQ (Equalizer): HIGH, HI-MID, LO-MID, LOW**

This is a four-band equalizer, providing adjustments for four frequency bands (HIGH, HI-MID, LO-MID, LOW). Setting the gain control to the “▼” position produces a flat response in the corresponding band. Turning the gain control to the right boosts the corresponding frequency band, while turning to the left attenuates the band. The HI-MID and LO-MID bands of monaural channels provide a frequency control that lets you adjust the center frequency.

The following table shows the EQ type, frequency, and maximum cut/boost for each of the bands.

**Monaural channel**

Band	Type	Frequency	Maximum Cut/Boost
HIGH	Shelving	10 kHz	±15 dB
HI-MID	Peaking	400 Hz – 8 kHz	
LO-MID	Peaking	80 Hz – 1.6 kHz	
LOW	Shelving	100 Hz	

**Stereo channel**

Band	Type	Frequency	Maximum Cut/Boost
HIGH	Shelving	10 kHz	±15 dB
HI-MID	Peaking	3 kHz	
LO-MID	Peaking	800 Hz	
LOW	Shelving	100 Hz	

**12 EQ ON Switch**

Switches the equalizer on or off.

**13 AUX Controls (1–8)**

These adjust the level of the signals sent from the input channel to AUX buses 1–8. These knobs should generally be set close to the “▼” (nominal) position. The signal adjusted by these controls is determined by the PRE switch (14).

**14 PRE Switches**

For each two buses, these switches select whether the signal sent to the AUX buses will be taken after the equalizer and before the channel fader (pre-fader), or after the channel fader (post-fader). If this switch is ON, the pre-fader signal is sent to the AUX bus, and will not be affected by the channel fader.

**NOTE**

- If necessary, the pre-fader signal sent to the AUX buses can be changed to the signal before the equalizer by changing an internal jumper. A fee will be charged for this modification. In this case, the signal will be sent to the AUX buses even if the input channel's ON switch is turned off. For details, contact to your Yamaha dealer listed at the end of this manual.

**15 PAN Control**

This control determines the stereo positioning of the monaural channel signal on the buses.

Rotate the knob clockwise to pan the signal to the odd channels of the GROUP buses and the ST L bus, and counter-clockwise to pan the signal to the even channels of the GROUP buses and the ST R bus.

**16 BAL Control**

Adjusts the left and right volume balance of stereo channels.

The signal input to the INPUT L jack will be sent to the odd channels of the GROUP buses or to the ST L bus, and the signal input to the INPUT R jack will be sent to the even channels of the GROUP buses or to the ST R bus.

**17 ON Switch/Indicator**

When this switch is on, that channel will be enabled and the indicator will light.

**NOTE**

- Even if the ON switch is off, you can turn on the PFL switch (21) and monitor the signal before the channel fader via the MONITOR OUT jacks and the PHONES jack.

**18 Input Meter**

Three LEDs indicate the input channel signal level after the equalizer. The “-20” LED will light if the input signal level reaches -20 dB, and the “0” LED will light at nominal level. The PEAK LED will light red when the input signal reaches 3 dB before clipping.

**19 Bus Assign Switches**

These switches determine the bus(es) to which each channel's signal is sent. Turning a switch on will output the signal to the corresponding bus.

- **1-2, 3-4, 5-6, 7-8 switches:** Assign the channel's signal to the GROUP 1/2–7/8 buses.
- **ST switch:** Assigns the channel's signal to the Stereo L and R buses.
- **MONO switch:** Assigns the channel's signal to the MONO bus.

**NOTE**

- If you want the signal to be output to the corresponding bus(es), turn on the channel ON switch (17).

**20 MUTE Switches (1–4)**

These assign the channel's mute on/off to switches 1–4. If you turn on the MUTE master switches (1–4) (page 15) located in the MUTE MASTER section, the input channels whose corresponding MUTE switch is on will be muted.

**NOTE**

- When a channel is muted, the ON indicator (17) will go dark.
- Even if a channel is muted, you can turn on the PFL switch (21) and monitor the signal before the channel fader via the MONITOR OUT jacks and the PHONES jack.

**21 PFL Switch/Indicator**

When the PFL switch is on, the indicator will light and the channel pre-fader signal is output to the PHONES and MONITOR OUT jacks for monitoring.

**NOTE**

- When you turn on the PFL switch, the PFL indicator of the MONITOR section (page 18) will light.

**22 Channel Fader**

Adjusts the output level of the input channel signal. Use these faders to adjust the balance between the various channels.

**NOTE**

- To minimize noise, the faders of unused channels should be set to the lowest position.
- The channel faders will affect the ST, MONO, GROUP 1–8, and AUX 1–8 (when the PRE switch is off) buses.

# Master Control Section

## Rear Panel

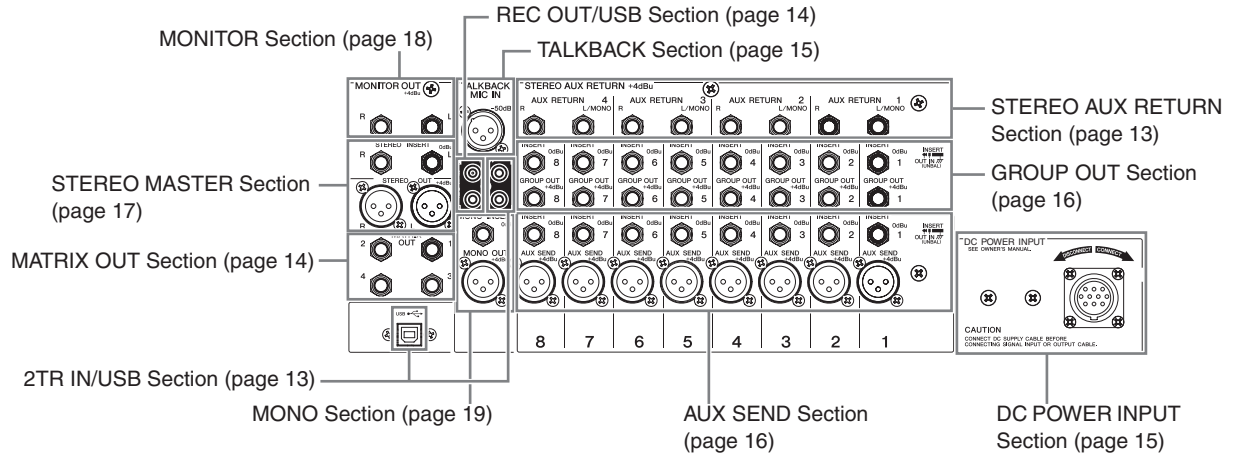

## Top Panel

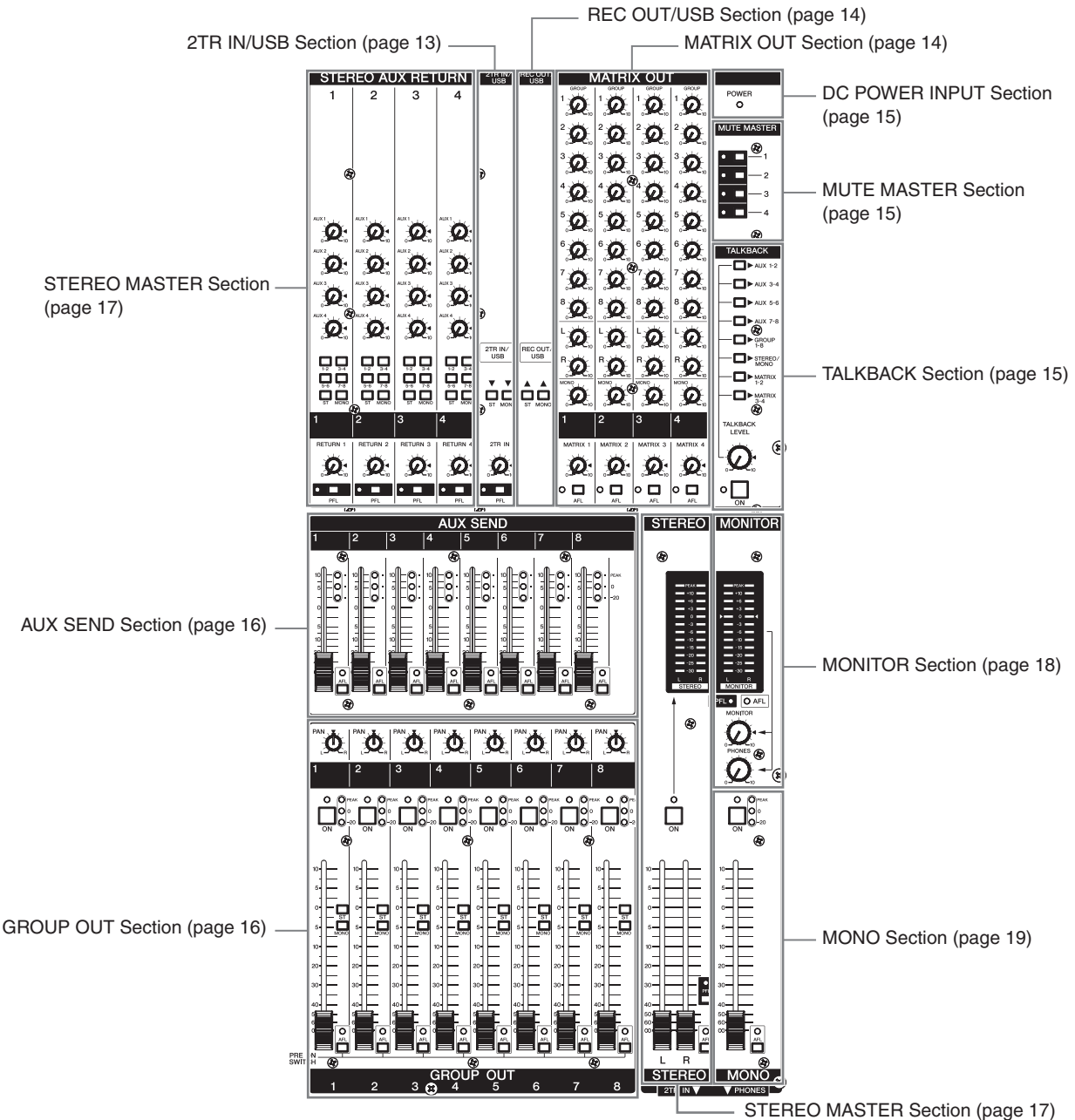

## STEREO AUX RETURN Section

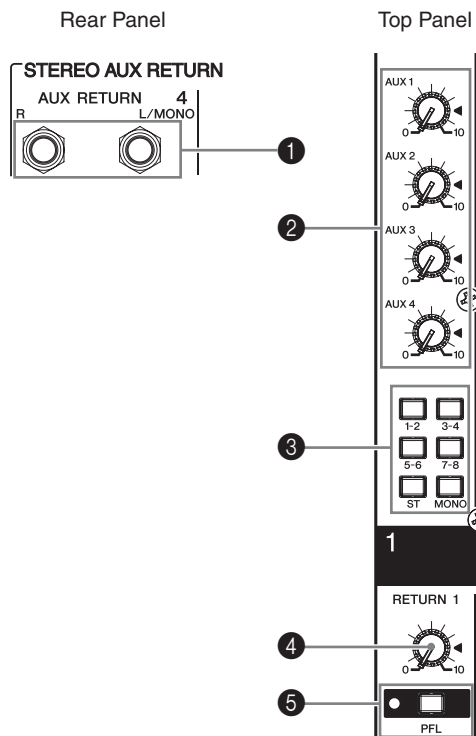

### 1 AUX RETURN Jacks

These are unbalanced phone-jack type line inputs. Signals input from these jacks can be sent to the GROUP 1/2–7/8, ST L/R, MONO, and AUX 1–4 buses. To the MONO and AUX 1–4 buses, a mix of the L/MONO and R signal is sent. These jacks are typically used to receive the signal returned from an external effect device (reverb, delay, etc.).

#### NOTE

- These jacks can also be used as auxiliary stereo inputs.
- If you connect to the L/MONO jack only, the mixer will recognize the signal as monaural and will send the identical signal to both the L/MONO and R jacks.

### 2 AUX Controls (1–4)

These adjust the level at which the signals from the AUX RETURN jacks are sent (with L and R mixed) to the AUX 1–4 buses.

The “▼” position of the knob is nominal level (0 dB).

### 3 Bus Assign Switches

These switches determine the bus(es) to which the signal is received from the AUX RETURN jacks.

- **1-2, 3-4, 5-6, 7-8 switches:** Send the signal to the GROUP 1/2–7/8 buses.
- **ST switch:** Sends the signal to the ST L/R bus.
- **MONO switch:** Sends the signal to the MONO bus.

### 4 RETURN Control

Adjusts the level of the signal sent from the AUX RETURN jacks to the GROUP 1/2–7/8, ST L/R, or MONO buses.

The “▼” position of the knob is nominal level (0 dB).

#### NOTE

- The signals sent to AUX 1–4 are not affected by the RETURN control.

### 5 PFL Switch/Indicator

When the PFL switch is on, the indicator will light and the signal before the AUX controls and RETURN control in the STEREO AUX RETURN section is output to the MONITOR OUT and PHONES jacks for monitoring.

#### NOTE

- When you turn on the PFL switch, the PFL indicator in the MONITOR section (page 18) will light.

## 2TR IN/USB Section

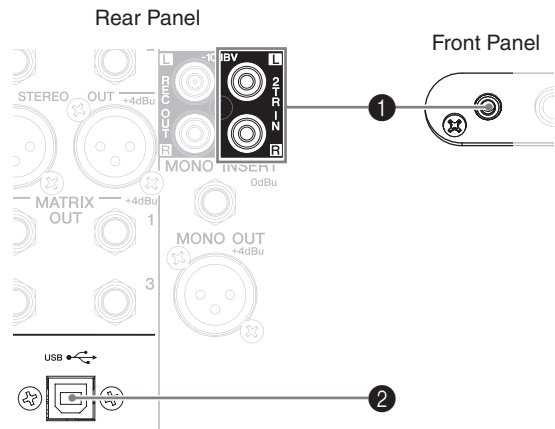

Top Panel

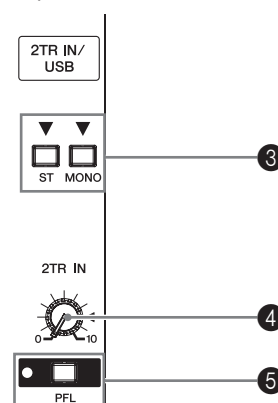

### 1 2TR IN Jacks

These are RCA pin jacks and a mini-phone jack (stereo) for inputting a stereo audio source. Use these jacks when you want to connect a CD player, and output the signal to the ST L/R or MONO bus.

#### NOTE

- If signals are simultaneously input from the 2TR IN jacks (RCA pin jacks, mini-phone jack) and the USB connector, the signals will be mixed.

### 2 USB Connector

Connects to the computer via the included cable to input and output the signals. This connector outputs the same signal as the REC OUT jacks. The signal input from this connector is sent to the ST L/R bus or the MONO bus.

When connecting or disconnecting the USB cable be sure to turn the 2TR IN/USB control all the way down.

#### Precautions when using the USB connector

When connecting the computer to the USB connector, make sure to observe the following points. Failing to do so risks freezing the computer and corrupting or losing

the data. If the computer or the instrument freezes, restart the application software or the computer OS, or turn the power to the instrument off then on again.



- Use an AB type USB cable of less than about 3 meters.
- To prevent loud pops and noises, turn on the power to your equipment in the following order; first the audio sources, then the PW8, and finally the power amplifiers. Reverse this order when turning the power off.
- Before connecting the computer to the USB connector, exit from any power-saving mode of the computer (such as suspended, sleep, standby).
- Before turning on the power to the instrument, connect the computer to the USB connector.
- Execute the following before turning the power to the instrument on/off or plugging/unplugging the USB cable to/from the USB connector.
  - Quit any open application software on the computer.
  - Make sure that data is not being transmitted from the instrument.
- While the computer is connected to the instrument, you should wait for six seconds or more between these operations: (1) when turning the power of the instrument off then on again, or (2) when alternately connecting/disconnecting the USB cable.

### 3 Bus Assign Switches

These switches determine the bus(es) to which the signal received from the 2TR IN jacks and the USB connector is sent.

- **ST switch:** Sends the signal to the ST L/R bus.
- **MONO switch:** Sends the mixed L and R signal to the MONO bus.

### 4 2TR IN/USB Control

Adjusts the level of the signal received from the 2TR IN jacks and the USB connector.

### 5 PFL Switch/Indicator

When the PFL switch is on, the indicator will light and the signal before the 2TR IN/USB control is output to the MONITOR OUT and PHONES jacks for monitoring.

#### NOTE

- When you turn on the PFL switch, the PFL indicator of the MONITOR section (page 18) will light.

## REC OUT/USB Section

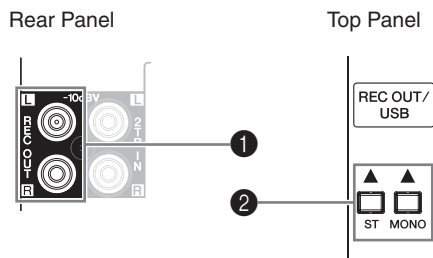

### 1 REC OUT Jacks

These RCA pin jacks can be connected to an external recorder such as an MD recorder in order to record the signal of the ST L/R bus or MONO bus.

#### NOTE

- The STEREO OUT master fader and MONO fader has no affect on the signal via these jacks.

### 2 Bus Assign Switches

These switches determine the signal sent to the REC OUT jacks and USB connector. If you're sending the signal of the MONO bus, the same signal will be output to the L and R of the REC OUT jacks and the USB connector.

- **ST switch:** The signal of the ST L/R bus will be output from the REC OUT jacks and the USB connector.
- **MONO switch:** The signal of the MONO bus will be output from the REC OUT jacks and the USB connector.

#### NOTE

- If both the ST switch and the MONO switch are on, the mixed signals of the ST L/R bus and MONO bus will be output.

## MATRIX OUT Section

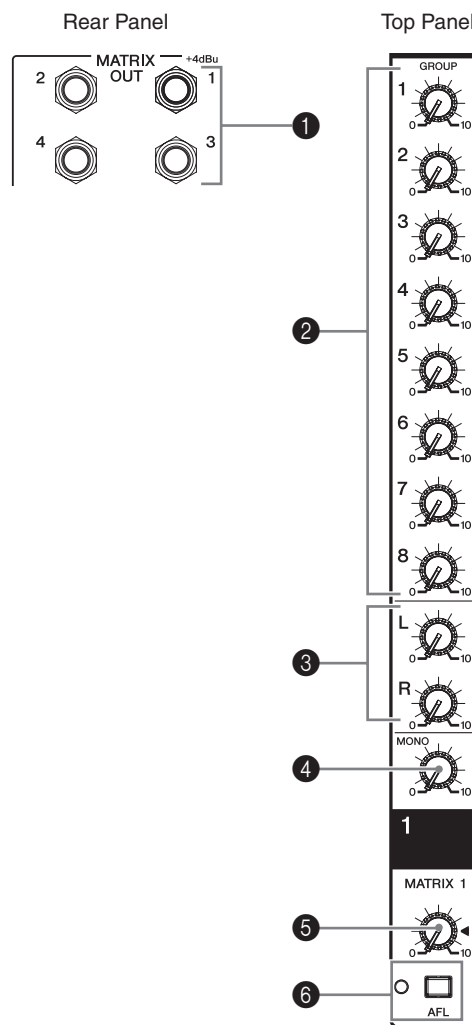

### 1 MATRIX OUT Jack

This is an impedance balanced (page 19) TRS phone-jack type output. This jack outputs the signal adjusted by the controls in the MATRIX OUT section.

### 2 GROUP Controls (1-8)

These adjust the level of the signals sent from GROUP OUT 1-8 to the MATRIX OUT jacks.

### 3 ST Controls (L, R)

These adjust the level of the signals sent from ST OUT L/R to the MATRIX OUT jacks.

**4 MONO Control**

This control adjusts the level of the signal sent from MONO OUT to the MATRIX OUT jacks.

**5 MATRIX master Control**

This control adjusts the overall level of the signal output to the MATRIX OUT jacks. The “▼” position of the knob is nominal level (0 dB).

**6 AFL Switch/Indicator**

When the AFL switch is on, the indicator will light and the signal after the MATRIX master control is output to the PHONES and MONITOR OUT jacks for monitoring.

**NOTE**

· If you want to monitor the signal after the MATRIX master control, turn off all PFL switches.

**DC POWER INPUT Section**

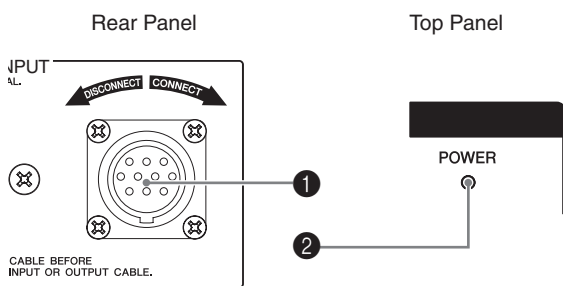

**1 DC POWER INPUT Connector**

Connects the Yamaha Power Supply PW8 to the console using the included power supply cable.

**!**

- Turn off the Yamaha PW8 power supply before you connect or disconnect the power supply cable to or from the console.
- To prevent loud pops and noises, turn on the power to your equipment in the following order; first the audio sources, then the PW8, and finally the power amplifiers. Reverse this order when turning the power off.

**2 POWER Indicator**

This will light when the Yamaha PW8 power supply is connected to the console and the PW8 is turned on.

**MUTE MASTER Section**

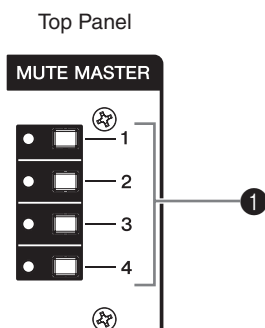

**1 MUTE Master Switches/Indicators (1-4)**

These switches toggle input channel muting on and off. Turning a switch (1-4) on will mute the input channels whose MUTE switch (page 10) of the corresponding number is turned on. When the signal is muted, the ON indicator of the input channels will go dark.

**TALKBACK Section**

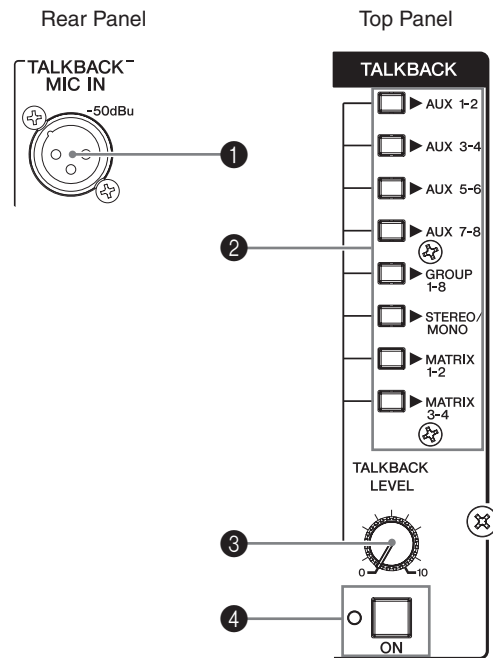

**1 TALKBACK MIC IN Jack**

This is an XLR-3-31 type unbalanced input jack for connecting a talkback microphone.

**2 Bus Assign Switches**

These determine the output destination of the signal from the TALKBACK MIC jack.

- **AUX 1-2, 3-4, 5-6, 7-8 switches:** Send the signal to the AUX 1/2-7/8 buses.
- **GROUP 1-8 switch:** Sends the signal to the GROUP 1-8 buses.
- **STEREO/MONO switch:** Sends the signal to the ST L/R and MONO buses.
- **MATRIX 1-2, 3-4 switches:** Send the signal to the MATRIX 1/2 or 3/4 buses.

**3 TALKBACK LEVEL Control**

Adjusts the level of the signal received from the TALKBACK MIC jack.

**4 ON Switch/Indicator**

When you turn this switch on, the indicator will flash and the talkback function will be enabled.

## AUX SEND Section

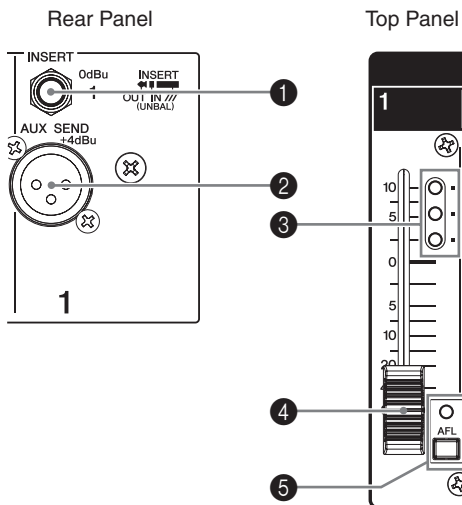

### 1 AUX INSERT Jack

This is an input/output jack located before the AUX SEND fader. You can connect a graphic equalizer or other signal processor. This is a TRS (tip, ring, sleeve) phone jack that carries both the send and return signal (tip = send/out; ring = return/in; sleeve = ground).

#### NOTE

· Patching external devices via an INSERT jack requires a special insert cable such as illustrated below (insert cable sold separately).

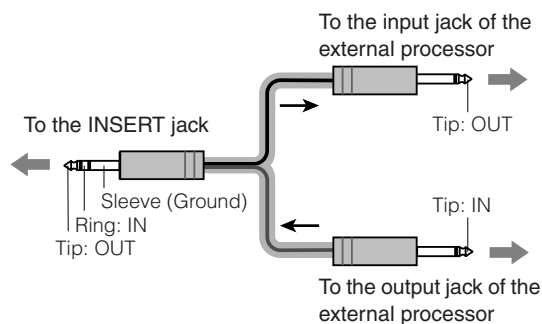

### 2 AUX SEND Jacks

These are balanced XLR-32 type output jacks (1: Ground; 2: Hot; 3: Cold). You can use these jacks, for example, to connect to a monitor system or an external effect unit.

### 3 AUX SEND Meter

Three LEDs indicate the signal level after the AUX SEND fader.

The “-20” LED will light if the output signal level reaches -20 dB, and the “0” LED will light at nominal level. The PEAK LED will light red when the output signal reaches 3 dB before clipping.

### 4 AUX SEND Fader

Controls the level of the signal output to the AUX SEND jack.

### 5 AFL Switch/Indicator

When the AFL switch is on, the indicator will light and the signal after the AUX SEND fader is output to the MONITOR OUT and PHONES jacks for monitoring.

#### NOTE

· If you want to monitor the signal after the AUX SEND fader, turn off all PFL switches.

## GROUP OUT Section

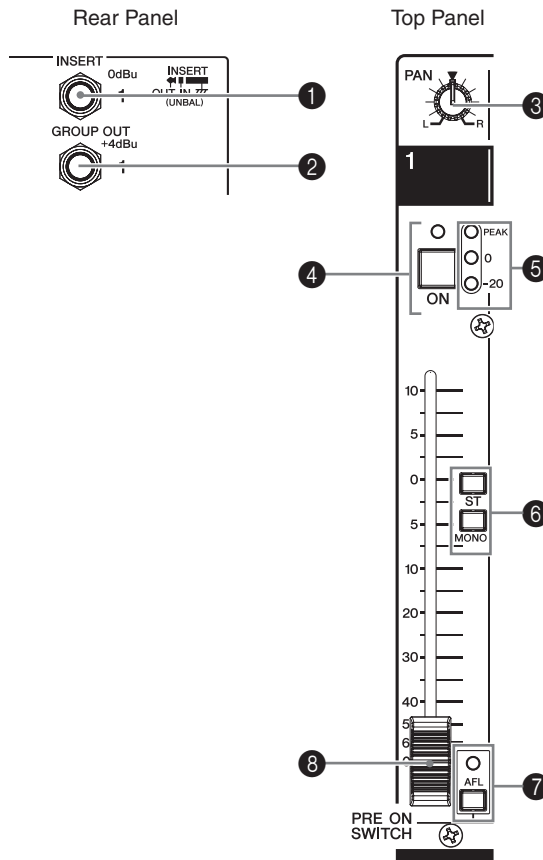

### 1 GROUP INSERT Jack

This is an input/output jack located before the GROUP OUT fader. You can connect a graphic equalizer or other signal processor. This is a TRS (tip, ring, sleeve) phone jack that carries both the send and return signal (tip = send/out; ring = return/in; sleeve = ground).

#### NOTE

· Patching external devices via an INSERT jack requires a special insert cable such as illustrated below (insert cable sold separately).

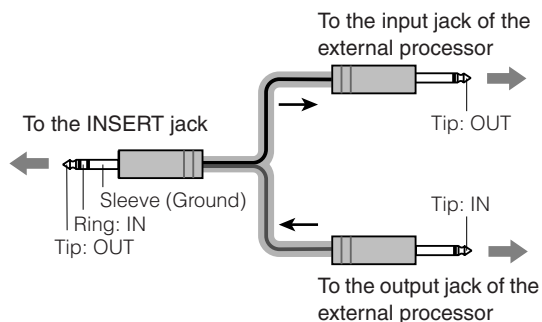



**2 GROUP OUT Jacks**

These are TRS phone type impedance-balanced (page 19) output jacks that output the GROUP OUT signals. You can connect these jacks to a multi-track recorder, external mixer, or other such device.

**3 PAN Controls**

These adjust the stereo position of the signals sent from GROUP OUT to the ST L/R bus. Rotate the knob clockwise to pan the signal right, and counter-clockwise to pan left.

**4 ON Switch/Indicator**

When this switch is on, that GROUP OUT will be enabled and the indicator will light.

**5 GROUP OUT Meter**

Three LEDs indicate the signal level after the GROUP OUT fader. The “-20” LED will light if the output signal level reaches -20 dB, and the “0” LED will light at nominal level. The PEAK LED will light red when the GROUP OUT signal reaches 3 dB before clipping.

**6 Bus Assign Switches**

These switches assign the GROUP OUT signal to the ST L/R bus and the MONO bus.

**NOTE**

- Turn the ON switch on if you want to send the GROUP OUT signal to the ST L/R bus or MONO bus.

**7 AFL Switch/Indicator**

When the AFL switch is on, the indicator will light and the signal after the GROUP OUT fader but before the ON switch is output to the MONITOR OUT and PHONES jacks for monitoring.

**NOTE**

- If you want to monitor the signal after the GROUP OUT fader, turn off all PFL switches.

**8 GROUP OUT Fader**

Controls the level of the GROUP OUT signal.

**STEREO MASTER Section**

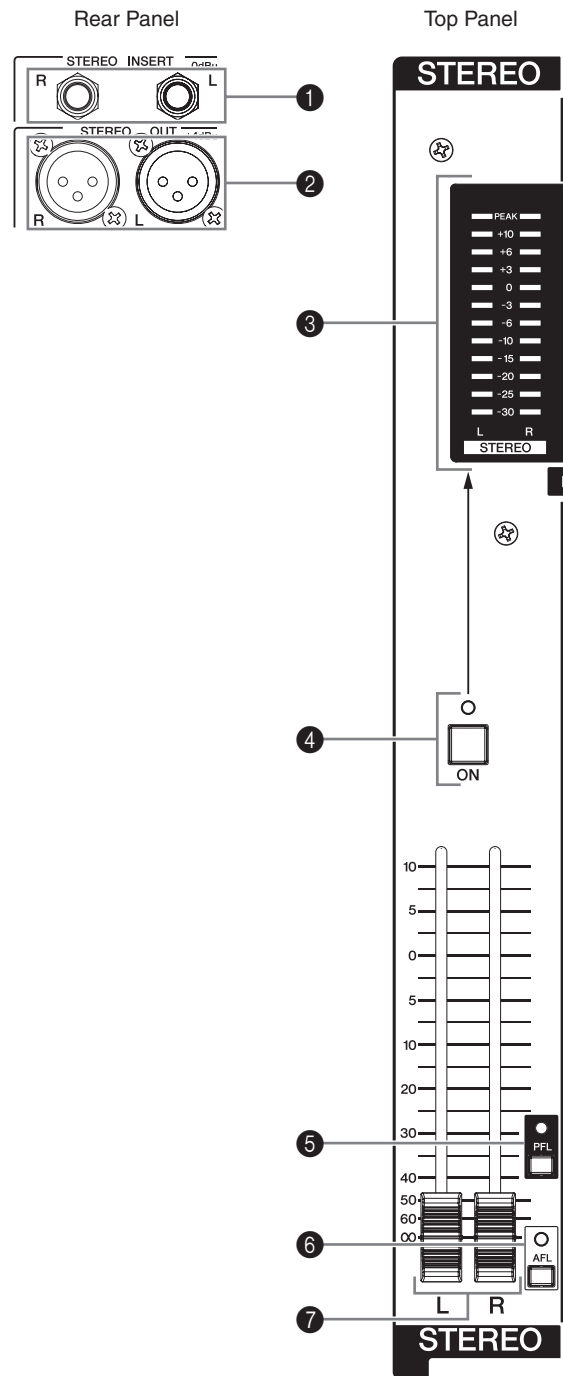

**1 STEREO INSERT Jack**

This is an input/output jack located before the STEREO OUT master fader. You can connect a graphic equalizer or other signal processor. This is a TRS (tip, ring, sleeve) phone jack that carries both the send and return signal (tip = send/out; ring = return/in; sleeve = ground).

**NOTE**

- Patching external devices via an INSERT jack requires a special insert cable such as illustrated below (insert cable sold separately).

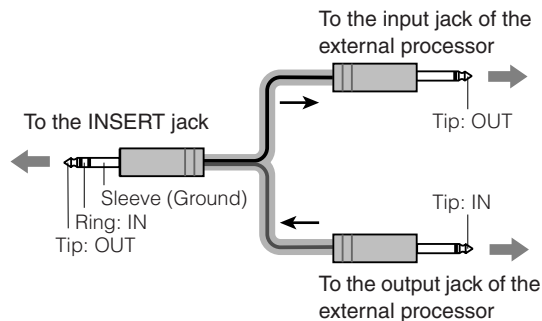

**2 STEREO OUT Jacks**

These are XLR-3-32 type balanced output jacks that output the mixed stereo signal. They output the signal adjusted by the STEREO OUT master faders (7). Connect these jacks to the power amplifiers that drive your main speakers.

**3 STEREO Level Meter**

These LEDs indicate the level of the signal sent to the STEREO OUT jacks. The "0" segment indicates the nominal output level. The PEAK segment lights red when the output approaches the clipping level.

**4 ON Switch/Indicator**

When this switch is on, ST OUT will be enabled and the indicator will light.

**5 PFL Switch/Indicator**

When the PFL switch is on, the indicator will light and the signal before the STEREO OUT master fader is output to the MONITOR OUT and PHONES jacks for monitoring.

**6 AFL Switch/Indicator**

When the AFL switch is on, the indicator will light and the signal after the STEREO OUT master faders is output to the PHONES and MONITOR OUT jacks for monitoring.

**NOTE**

- If you want to monitor the signal after the STEREO OUT master faders, turn off all PFL switches.

**7 STEREO OUT Master Faders**

These adjust the signal level sent to the STEREO OUT jacks.

**MONITOR Section**

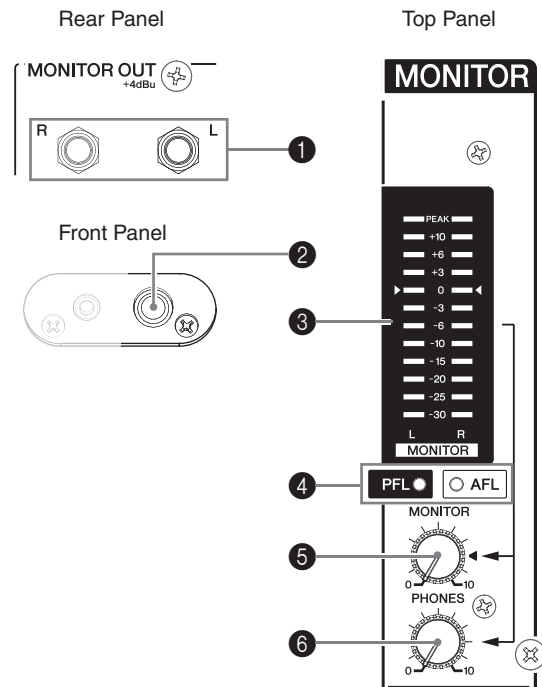

**1 MONITOR OUT Jacks**

These are impedance-balanced (page 19) TRS phone-type output jacks that you can connect to your monitor system. These jacks output the signal before or after the faders for the various buses. The PFL/AFL indicator (4) and the PFL and AFL indicators in each section indicate which signal is being output.

**NOTE**

- If both a PFL switch and AFL switch are on, the PFL switch will be enabled. If you want to monitor the signals after the faders, turn off all PFL switches.

**2 PHONES Jack**

Connects a pair of headphones to this stereo phone-type output jack. These jacks output the signal before or after the faders for the various buses.

**3 MONITOR Level Meter**

Indicates the level of the signal output to the MONITOR OUT and PHONES jacks.

The "0" segment indicates the nominal output level. The PEAK segment lights red when the output approaches the clipping level.

**4 PFL/AFL Indicator**

Indicates the signal sent to the MONITOR OUT and PHONES jacks. The PFL indicator will light when the signals before the faders (control) are being sent; the AFL indicator will light if the signals after the faders are being sent.

**5 MONITOR Control**

Controls the level of the signal output to the MONITOR OUT jacks.

**6 PHONES Control**

Controls the level of the signal output to the PHONES jack.

## MONO Section

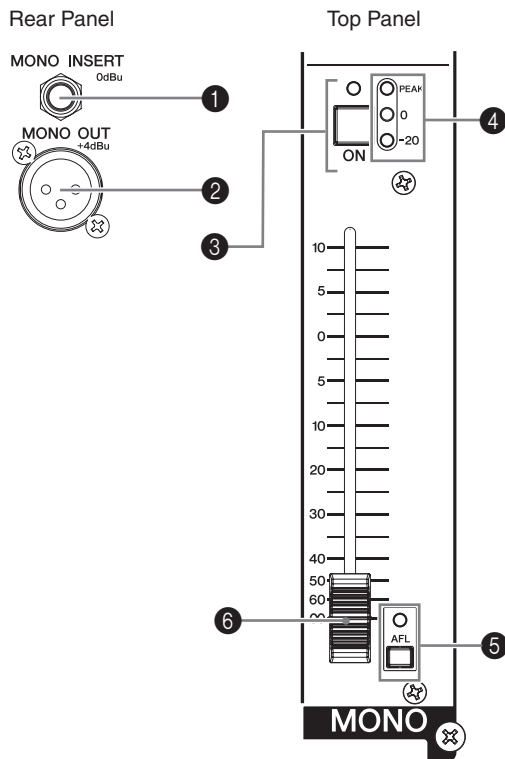

### 1 MONO INSERT Jack

This is an input/output jack located before the MONO fader.

You can connect a graphic equalizer or other signal processor. This is a TRS (tip, ring, sleeve) phone jack that carries both the send and return signal (tip = send/out; ring = return/in; sleeve = ground).

#### NOTE

- Patching external devices via an INSERT jack requires a special insert cable such as illustrated below (insert cable sold separately).

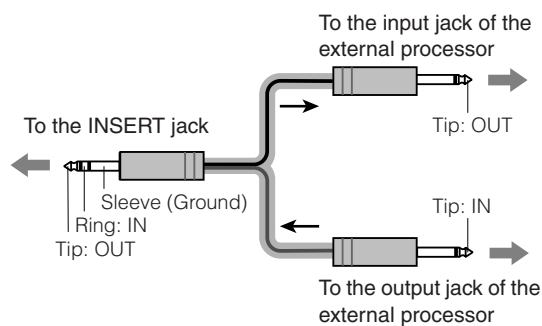

### 2 MONO OUT Jack

This is an XLR-3-32 type balanced output jack that outputs the MONO OUT signal.

### 3 ON Switch/Indicator

When this switch is on, the MONO OUT will be enabled and the indicator will light.

### 4 MONO Level Meter

Three LEDs indicate the signal level after the MONO fader. The “-20” LED will light if the output signal level reaches -20 dB, and the “0” LED will light at nominal level. The PEAK LED will light red when the MONO OUT signal reaches 3 dB before clipping.

### 5 AFL Switch/Indicator

When the AFL switch is on, the indicator will light and the signal after the MONO fader is output to the MONITOR OUT and PHONES jacks for monitoring.

#### NOTE

- If you want to monitor the signal after the MONO fader, turn off all PFL switches.

### 6 MONO Fader

Controls the level of the signal output to the MONO jack.

## LAMP Connector



This is an XLR-4-31 type connector that supplies power to a separately sold gooseneck lamp (e.g., Yamaha LA5000). The IM8-40 mixer has three of these connectors, and the IM8-32/24 mixers have two.

#### Impedance balanced:

Since the hot and cold terminals of impedance balanced output jacks have the same output impedance, these output jacks are less affected by induced noise.

# Troubleshooting

## Power doesn't come on.

- Is the dedicated PW8 power supply properly plugged into an appropriate AC power outlet?
- Is the dedicated PW8 power supply properly connected using the included power supply cable?  
The PW8 itself will not power-on unless it is correctly connected via the included power cable.
- If the above checks do not identify the problem, call Yamaha for service.

## The sound of the bass drum will not move forward in the mix.

- Could you be mixing a phase-reversed signal?  
Try turning on the  $\phi$  switch to reverse the phase. If you are capturing the sound using multiple mics, phase reversal may be causing cancellation.

## How can I send the pre-EQ signal to an AUX bus for monitoring?

- You can send the pre-EQ signal to an AUX bus by changing an internal jumper setting. Turn the AUX PRE switch on (pre-fader). In this case, the signal will be sent to the AUX bus even if the input channel's ON switch is off.

## How can I monitor the signal of a GROUP bus before I send it to the ST L/R bus?

- With the GROUP section ON switch turned off, turning the GROUP section AFL switch on will let you monitor the AFL signal of the GROUP bus without sending it to the ST L/R (and MONO) bus.

## How can I send a compressed signal to the ST L/R bus while sending the uncompressed signal to DIRECT OUT jacks for recording?

- If you connect a compressor (external device) to the INSERT jacks and apply compression to the signal being sent to the ST L/R bus, the signal before the compressor will be sent to the DIRECT OUT jacks. In this case, turn off the IM8's COMP control.

## How can I send the TALKBACK signal only to the intercom?

- In the TALKBACK section, turn on only MATRIX 1-2 (or MATRIX 3-4) to send the output of MATRIX 1-2 (or MATRIX 3-4) to the intercom.

## How can I play background music from a portable audio player?

- A standard mini-phone type 2TR IN jack is provided on the front panel, allowing you to connect your portable audio player via a mini-plug cable.

## How can I assign the MC to the MONO bus and also record it?

- Assign the MC's input channel to the MONO bus, and use the REC OUT section bus assign switch to select the MONO bus.

# About the accessory disk

## **SPECIAL NOTICE**

The software included in the accessory disk and the copyrights thereof are under exclusive ownership by Steinberg Media Technologies GmbH.

Use of the software and this manual is governed by the license agreement which the purchaser fully agrees to upon breaking the seal of the software packaging. (Please read carefully the Software Licensing Agreement at the end of this manual before installing the application.)

Copying of the software or reproduction of this manual in whole or in part by any means is expressly forbidden without the written consent of the manufacturer.

Yamaha makes no representations or warranties with regard to the use of the software and documentation and cannot be held responsible for the results of the use of this manual and the software.

This disk is NOT for audio/visual purpose. Do not attempt to play the disk on an audio/visual CD/DVD player. Doing so may result in irreparable damage to your player.

For information about the minimum system requirements and latest information of the software in the disk, check the web site below.

<<http://www.yamahasyth.com/>>

Note that Yamaha does not offer technical support for the DAW software in the accessory disk.

## **About the DAW software in the accessory disk**

The accessory disk contains DAW software both for Windows and Macintosh.

## **NOTE**

- Make sure to install DAW software under the "Administrator" account.
- In order to have continuous use of the DAW software in the accessory disk, including support and other benefits, you will need to register the software and activate your software license by starting it while the computer is connected to the Internet. Click the "Register Now" button shown when the software is started, then fill in all required fields for registration. If you do not register the software, you will be unable to use it after a limited period of time expires.
- If you are using a Macintosh computer, double-click the "\*\*\*\*.mpkg" file to start installation.

For information about the minimum system requirements and latest information on the software in the disk, check the web site below.

<<http://www.yamahasyth.com/>>

## **About software support**

Support for the DAW software in the accessory disk is provided by Steinberg on its website at the following address.  
<http://www.steinberg.net>

You can visit the Steinberg site also via the Help menu of the included DAW software. (The Help menu also includes the PDF manual and other information on the software.)

## ATTENTION

# SOFTWARE LICENSE AGREEMENT

PLEASE READ THIS SOFTWARE LICENSE AGREEMENT ("AGREEMENT") CAREFULLY BEFORE USING THIS SOFTWARE. YOU ARE ONLY PERMITTED TO USE THIS SOFTWARE PURSUANT TO THE TERMS AND CONDITIONS OF THIS AGREEMENT. THIS AGREEMENT IS BETWEEN YOU (AS AN INDIVIDUAL OR LEGAL ENTITY) AND YAMAHA CORPORATION ("YAMAHA").

BY BREAKING THE SEAL OF THIS PACKAGE YOU ARE AGREEING TO BE BOUND BY THE TERMS OF THIS LICENSE. IF YOU DO NOT AGREE WITH THE TERMS, DO NOT INSTALL, COPY, OR OTHERWISE USE THIS SOFTWARE.

THIS AGREEMENT PROVIDES YOUR USE-CONDITIONS ABOUT THE "DAW" SOFTWARE OF STEINBERG MEDIA TECHNOLOGIES GMBH("STEINBERG") WHICH IS BUNDLED WITH THIS PRODUCT. SINCE THE END-USER SOFTWARE LICENSE AGREEMENT (EUSLA) SHOWN ON YOUR PC-DISPLAY IN YOUR INSTALLING THE "DAW" SOFTWARE IS REPLACED BY THIS AGREEMENT, YOU SHOULD DISREGARD THE EUSLA. THAT IS, IN THE INSTALLING PROCESS, YOU SHOULD SELECT "AGREE" WITH THE EUSLA, WITHOUT YOUR JUDGMENT THERETO, SO AS TO PROCEED TO THE NEXT PAGE.

### 1. GRANT OF LICENSE AND COPYRIGHT

Yamaha hereby grants you the right to use one copy of the software program(s) and data ("SOFTWARE") accompanying this Agreement. The term SOFTWARE shall encompass any updates to the accompanying software and data. The SOFTWARE is owned by STEINBERG, and is protected by relevant copyright laws and all applicable treaty provisions. Yamaha has acquired the sublicense right to license you to use the SOFTWARE. While you are entitled to claim ownership of the data created with the use of SOFTWARE, the SOFTWARE will continue to be protected under relevant copyrights.

- **You may** use the SOFTWARE on a **single computer**.
- **You may** make one copy of the SOFTWARE in machine-readable form for backup purposes only, if the SOFTWARE is on media where such backup copy is permitted. On the backup copy, you must reproduce Yamaha's copyright notice and any other proprietary legends that were on the original copy of the SOFTWARE.
- **You may** permanently transfer to a third party all your rights in the SOFTWARE only when you transfer this product together, provided that you do not retain any copies and the recipient reads and agrees to the terms of this Agreement.

### 2. RESTRICTIONS

- **You may not** engage in reverse engineering, disassembly, decompilation or otherwise deriving a source code form of the SOFTWARE by any method whatsoever.
- **You may not** reproduce, modify, change, rent, lease, or distribute the SOFTWARE in whole or in part, or create derivative works of the SOFTWARE.
- **You may not** electronically transmit the SOFTWARE from one computer to another or share the SOFTWARE in a network with other computers.
- **You may not** use the SOFTWARE to distribute illegal data or data that violates public policy.
- **You may not** initiate services based on the use of the SOFTWARE without permission by Yamaha Corporation.

Copyrighted data, including but not limited to MIDI data for songs, obtained by means of the SOFTWARE, are subject to the following restrictions which you must observe.

- Data received by means of the SOFTWARE may not be used for any commercial purposes without permission of the copyright owner.
- Data received by means of the SOFTWARE may not be duplicated, transferred, or distributed, or played back or performed for listeners in public without permission of the copyright owner.
- The encryption of data received by means of the SOFTWARE may not be removed nor may the electronic watermark be modified without permission of the copyright owner.

### 3. TERMINATION

This Agreement becomes effective on the day that you receive the SOFTWARE and remains effective until terminated. If any copyright law or provisions of this Agreement is violated, the Agreement shall terminate automatically and immediately without notice from Yamaha. Upon such termination, you must immediately destroy the licensed SOFTWARE, any accompanying written documents and all copies thereof.

### 4. LIMITED WARRANTY ON MEDIA

As to SOFTWARE sold on tangible media, Yamaha warrants that the tangible media on which the SOFTWARE is recorded will be free from defects in materials and workmanship under normal use for a period of fourteen (14) days from the date of receipt, as evidenced by a copy of the receipt. Yamaha's entire liability and your exclusive remedy will be replacement of the defective media if it is returned to Yamaha or an authorized Yamaha dealer within fourteen days with a copy of the receipt. Yamaha is not responsible for replacing media damaged by accident, abuse or misapplication. TO THE FULLEST EXTENT PERMITTED BY LAW, YAMAHA EXPRESSLY DISCLAIMS ANY IMPLIED WARRANTIES ON THE TANGIBLE MEDIA, INCLUDING THE IMPLIED WARRANTIES OF MERCHANTABILITY AND FITNESS FOR A PARTICULAR PURPOSE.

### 5. DISCLAIMER OF WARRANTY ON SOFTWARE

You expressly acknowledge and agree that use of the SOFTWARE is at your sole risk. The SOFTWARE and related documentation are provided "AS IS" and without warranty of any kind. NOTWITHSTANDING ANY OTHER PROVISION OF THIS AGREEMENT, YAMAHA EXPRESSLY DISCLAIMS ALL WARRANTIES AS TO THE SOFTWARE, EXPRESS, AND IMPLIED, INCLUDING BUT NOT LIMITED TO THE IMPLIED WARRANTIES OF MERCHANTABILITY, FITNESS FOR A PARTICULAR PURPOSE AND NON-INFRINGEMENT OF THIRD PARTY RIGHTS. SPECIFICALLY, BUT WITHOUT LIMITING THE FOREGOING, YAMAHA DOES NOT WARRANT THAT THE SOFTWARE WILL MEET YOUR REQUIREMENTS, THAT THE OPERATION OF THE SOFTWARE WILL BE UNINTERRUPTED OR ERROR-FREE, OR THAT DEFECTS IN THE SOFTWARE WILL BE CORRECTED.

### 6. LIMITATION OF LIABILITY

YAMAHA'S ENTIRE OBLIGATION HEREUNDER SHALL BE TO PERMIT USE OF THE SOFTWARE UNDER THE TERMS HEREOF. IN NO EVENT SHALL YAMAHA BE LIABLE TO YOU OR ANY OTHER PERSON FOR ANY DAMAGES, INCLUDING, WITHOUT LIMITATION, ANY DIRECT, INDIRECT, INCIDENTAL OR CONSEQUENTIAL DAMAGES, EXPENSES, LOST PROFITS, LOST DATA OR OTHER DAMAGES ARISING OUT OF THE USE, MISUSE OR INABILITY TO USE THE SOFTWARE, EVEN IF YAMAHA OR AN AUTHORIZED DEALER HAS BEEN ADVISED OF THE POSSIBILITY OF SUCH DAMAGES. In no event shall Yamaha's total liability to you for all damages, losses and causes of action (whether in contract, tort or otherwise) exceed the amount paid for the SOFTWARE.

### 7. GENERAL

This Agreement shall be interpreted according to and governed by Japanese law without reference to principles of conflict of laws. Any dispute or procedure shall be heard before the Tokyo District Court in Japan. If for any reason a court of competent jurisdiction finds any portion of this Agreement to be unenforceable, the remainder of this Agreement shall continue in full force and effect.

### 8. COMPLETE AGREEMENT

This Agreement constitutes the entire agreement between the parties with respect to use of the SOFTWARE and any accompanying written materials and supersedes all prior or contemporaneous understandings or agreements, written or oral, regarding the subject matter of this Agreement. No amendment or revision of this Agreement will be binding unless in writing and signed by a fully authorized representative of Yamaha.



# Specifications

## Electrical Specifications

			MIN	TYP	MAX	UNIT	
<b>Frequency Response</b>	STEREO OUT GROUP OUT AUX SEND MONITOR OUT REC OUT	GAIN: min (MONO CH INPUT*, ST CH INPUT 1-4) 20 Hz-20 kHz Nominal output level @ 1 kHz Input: MONO CHs*, ST CHs 1-4, AUX RETURN, 2TR IN	-3.0	0.0	1.0	dB	
<b>Total Harmonic Distortion (THD + N)</b>	STEREO OUT	+14 dBu @ 20 Hz-20 kHz, GAIN: min			0.1	%	
<b>Hum &amp; Noise</b> Hum & Noise are measured with a 6 dB/octave filter @ 12.7 kHz; equivalent to a 20 kHz filter with infinite dB/octave attenuation.	MONO CH INPUT*	EIN (Equivalent Input Noise) Rs = 150 Ω, GAIN: max			-128	dBu	
	STEREO OUT GROUP OUT	STEREO OUT, GROUP OUT faders at nominal level and all CH assign switches off.			-80	dBu	
	AUX SEND	AUX SEND faders at nominal level and all CH AUX controls at minimum.			-75	dBu	
	STEREO OUT GROUP OUT	STEREO OUT, GROUP OUT faders and one CH fader at nominal level.			-64	dBu	
	STEREO OUT	Residual output noise			-98	dBu	
<b>Crosstalk (1 kHz)</b>	Adjacent Input	MONO CH INPUT*, GAIN: min			-70	dB	
	Input to Output	STEREO OUT L/R, MOMO CH INPUT*, PAN: panned hard left or right			-70	dB	
<b>Maximum Voltage Gain (1 kHz)</b> All faders and controls are maximum when measured. PAN/BAL: panned hard left or hard right.	Rs = 150 Ω INPUT GAIN: max From MONO CH INPUT*	INSERT OUT (MONO CH)		60		dB	
		DIRECT OUT (MONO CH)		60		dB	
		INSERT OUT (STEREO, GROUP, MONO)		70		dB	
		STEREO OUT		84		dB	
		GROUP OUT		84		dB	
		MATRIX OUT		90		dB	
		REC OUT		62.2		dB	
		MONO OUT		84		dB	
		MONITOR OUT		70		dB	
		PHONES OUT		79		dB	
		AUX SEND, PRE		80		dB	
		AUX SEND, POST		90		dB	
		INSERT OUT (AUX), PRE		66		dB	
		INSERT OUT (AUX), POST		76		dB	
	Rs = 150 Ω INPUT GAIN: max From ST CH INPUT 1-4	STEREO OUT			58		dB
		GROUP OUT			58		dB
		AUX SEND, PRE			51		dB
		AUX SEND, POST			61		dB
	From AUX RETURN	STEREO OUT			16		dB
		GROUP OUT			16		dB
AUX SEND				13		dB	
From 2TR IN	STEREO OUT			27.8		dB	
From TALKBACK MIC IN	STEREO OUT			70		dB	
	GROUP OUT			70		dB	
	AUX OUT			70		dB	

All faders are nominal when measured. (The nominal position is 10 dB lower than the maximum position.)

Output impedance of signal generator: 150 ohms

\* IM8-40: 1-40, IM8-32: 1-32, IM8-24: 1-24



## General Specifications

<b>Input HPF</b>	MONO CH INPUT*	80 Hz, 12 dB/oct
<b>Input Equalization</b>  (+15, -15dB maximum) Turn over/roll-off frequency of shelving: 3dB below maximum variable level.	MONO CH INPUT*	HIGH: 10 kHz (shelving) Hi-MID: 400 Hz-8 kHz (peaking) LO-MID: 80 Hz-1.6 kHz (peaking) LOW: 100 Hz (shelving)
	ST CH INPUT	HIGH: 10 kHz (shelving) Hi-MID: 3 kHz (peaking) LO-MID: 800 Hz (peaking) LOW: 100 Hz (shelving)
<b>LAMP</b> IM8-40: 3 pcs, IM8-32/24: 2pcs		XLR-4-31 type, The LAMP voltage is 12 V DC between 3 and 4 pins of XLR-4-31 connectors. Each lamp can use 5 W max.
<b>Signal Indicator</b>	MONO CH INPUT* ST CH INPUT 1-4 INSERT OUT	3 points LED meter (PEAK, 0, -20 dB) PEAK lights if the signal reaches 3dB below the clipping level.
	GROUP OUT, AUX SEND, MONO OUT	
<b>LED Level Meter</b>	Post STEREO OUT fader Pre MONITOR control	4x12 points LED meters (PEAK, +10, +6, +3, 0, -3, -6, -10, -15, -20, -25, -30 dB)
<b>USB Audio</b>	USB IN/OUT	Sampling Frequency = 44.1/48 kHz (depending on the PC application)
<b>Compressor</b>	MONO CH INPUT*	Control x 1 (gain/threshold/ratio)
<b>Dimensions</b>		Height: 219 mm, Depth: 739 mm, Width: 1716 mm (IM8-40), 1471.5 mm (IM8-32), 1227 mm (IM8-24)
<b>Net Weight</b>		51.5 kg (IM8-40), 44.4 kg (IM8-32), 37.8 kg (IM8-24)

All faders are nominal when measured. (The nominal position is 10 dB lower than the maximum position.)

Output impedance of signal generator: 150 ohms

\* IM8-40: 1-40, IM8-32: 1-32, IM8-24: 1-24

## Analog Input Specifications

Input Connectors	PAD	GAIN	Input Impedance	Appropriate Impedance	Sensitivity*	Nominal Level	Max. before clipping	Connector Specifications
INPUT A (MONO CHs) IM8-40: 1-40 IM8-32: 1-32 IM8-40: 1-24	0	-60 dB	3 k $\Omega$	50-600 $\Omega$ Mics	-80 dBu (0.078 mV)	-60 dBu (0.775 mV)	-40 dBu (7.75 mV)	XLR-3-31 type (balanced [1=GND, 2=HOT, 3=COLD])
		-16 dB			-36 dBu (12.3 mV)	-16 dBu (123 mV)	+4 dBu (1.23 V)	
	26 dB	-34 dB			-54 dBu (1.55 mV)	-34 dBu (15.5 mV)	-14 dBu (155 mV)	
		+10 dB			-10 dBu (245 mV)	+10 dBu (2.45 V)	+30 dBu (24.5 V)	
INPUT B (MONO CHs) IM8-40: 1-40 IM8-32: 1-32 IM8-40: 1-24	0	-60 dB	10 k $\Omega$	600 $\Omega$ Mics/Lines	-80 dBu (0.078 mV)	-60 dBu (0.775 mV)	-40 dBu (7.75 mV)	TRS phone jack (balanced [Tip = HOT, Ring = COLD, Sleeve = GND])
		-16 dB			-36 dBu (12.3 mV)	-16 dBu (123 mV)	+4 dBu (1.23 V)	
	26 dB	-34 dB			-54 dBu (1.55 mV)	-34 dBu (15.5 mV)	-14 dBu (155 mV)	
		+10 dB			-10 dBu (245 mV)	+10 dBu (2.45 V)	+30 dBu (24.5 V)	
INPUT A/B (ST CHs)	-	-34 dB	10 k $\Omega$	600 $\Omega$ Lines	-54 dBu (1.55 mV)	-34 dBu (15.5 mV)	-14 dBu (155 mV)	Phone jack (unbalanced) RCA pin jack
		+10 dB			-10 dBu (245 mV)	+10 dBu (2.45 V)	+30 dBu (24.5 V)	
INSERT IN (MONO CHs) IM8-40: 1-40 IM8-32: 1-32 IM8-40: 1-24	-	-	10 k $\Omega$	600 $\Omega$ Lines	-20 dBu (77.5 mV)	0 dBu (0.775 V)	+20 dBu (7.75 V)	TRS phone jack (unbalanced [Tip = Out, Ring = In, Sleeve = GND])
INSERT IN (AUX, GROUP, STEREO, MONO)	-	-	10 k $\Omega$	600 $\Omega$ Lines	-10 dBu (77.5 mV)	0 dBu (0.775 V)	+10 dBu (2.45 V)	TRS phone jack (unbalanced [Tip = Out, Ring = In, Sleeve = GND])
AUX RETURN 1-4	-	-	10 k $\Omega$	600 $\Omega$ Lines	-12 dBu (195 mV)	+4 dBu (1.23 V)	+24 dBu (12.3 V)	Phone jack (unbalanced)
2TR IN L/R	-	-	10 k $\Omega$	600 $\Omega$ Lines	-26 dBV (50.1 mV)	-10 dBV (0.316 V)	+10 dBV (3.16 V)	Phone jack (unbalanced)
								3.5 DIA stereo phone jack
TALKBACK MIC IN	-	-	10 k $\Omega$	600 $\Omega$ Lines	-66 dBu (0.389 mV)	-50 dBu (2.45 mV)	-30 dBu (24.5 mV)	XLR-3-31 type (unbalanced)

Where 0 dBu = 0.775 Vrms and 0 dBV = 1 Vrms

\* Sensitivity is the lowest level that will produce an output of +4dB (1.23 V), or the nominal output level when the unit is set to the maximum level. (All faders and level controls are at their maximum positions.)

## Analog Output Specifications

Output Connectors	Output Impedance	Appropriate Impedance	Nominal Level	Max. before clipping	Connector Specifications
STEREO OUT L/R	75 $\Omega$	600 $\Omega$ Lines	+4 dBu (1.23 V)	+24 dBu (12.3 V)	XLR-3-32 type (balanced [1 = GND, 2 = HOT, 3 = COLD])
GROUP OUT 1-8	150 $\Omega$	10 k $\Omega$ Lines	+4 dBu (1.23 V)	+20 dBu (7.75 V)	TRS phone jack (impedance balanced [Tip = HOT, Ring = COLD, Sleeve = GND])
AUX SEND 1-8	75 $\Omega$	600 $\Omega$ Lines	+4 dBu (1.23 V)	+24 dBu (12.3 V)	XLR-3-32 type (balanced [1 = GND, 2 = HOT, 3 = COLD])
MATRIX OUT 1-8	150 $\Omega$	10 k $\Omega$ Lines	+4 dBu (1.23 V)	+20 dBu (7.75 V)	TRS phone jack (impedance balanced [Tip = HOT, Ring = COLD, Sleeve = GND])
MONO OUT	75 $\Omega$	600 $\Omega$ Lines	+4 dBu (1.23 V)	+24 dBu (12.3 V)	XLR-3-32 type (balanced [1 = GND, 2 = HOT, 3 = COLD])
INSERT OUT (MONO CHs)	150 $\Omega$	10 k $\Omega$ Lines	0 dBu (0.775 V)	+20 dBu (7.75 V)	Phone jack (unbalanced [Tip: Out, Ring = In, Sleeve = GND])
INSERT OUT (AUX, GROUP, STEREO, MONO)	150 $\Omega$	10 k $\Omega$ Lines	0 dBu (0.775 V)	+20 dBu (7.75 V)	Phone jack (unbalanced [Tip: Out, Ring = In, Sleeve = GND])
DIRECT OUT (MONO CHs)	150 $\Omega$	10 k $\Omega$ Lines	0 dBu (0.775 V)	+20 dBu (7.75 V)	TRS phone jack (impedance balanced [Tip = HOT, Ring = COLD, Sleeve = GND])
REC OUT L/R	600 $\Omega$	10 k $\Omega$ Lines	-10 dBV (0.316 V)	+10 dBV (3.16 V)	RCA pin jack
MONITOR OUT L/R	150 $\Omega$	10 k $\Omega$ Lines	+4 dBu (1.23 V)	+20 dBu (7.75 V)	TRS phone jack (impedance balanced [Tip = HOT, Ring = COLD, Sleeve = GND])
PHONES	100 $\Omega$	40 $\Omega$ Phones	3 mW	75 mW	Stereo phone jack

Where 0 dBu = 0.775 Vrms and 0 dBV = 1 Vrms

## Digital Input/Output Specifications

Connector	Format	Data Length	Connector Specifications
USB	USB AUDIO 1.1	16 bit	USB B type

## Jack List

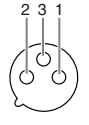
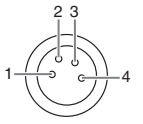
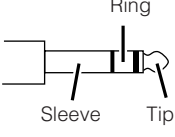
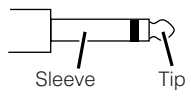
Input/Output Jacks	Polarities	Configurations
INPUT A (monaural), AUX SEND, STEREO OUT, MONO OUT, TALKBACK	Pin 1: Ground Pin 2: Hot (+) Pin 3: Cold (-)	<div style="display: flex; justify-content: space-around;"> <div style="text-align: center;"> <p>INPUT</p>  </div> <div style="text-align: center;"> <p>OUTPUT</p>  </div> </div> <p>XLR-3-31/XLR-3-32 Jack</p>
LAMP	Pin 1: NC Pin 2: NC Pin 3: Ground Pin 4: +12 V	 <p>XLR-4-31 Jack</p>
INPUT B (monaural), GROUP OUT, MATRIX OUT, MONITOR OUT	Tip: Hot (+) Ring: Cold (-) Sleeve: Ground	 <p>TRS Phone Jack</p>
CH INSERT, AUX INSERT, GROUP INSERT, STEREO INSERT, MONO INSERT	Tip: Output Ring: Input Sleeve: Ground	
PHONES	Tip: L Ring: R Sleeve: Ground	
INPUT A (stereo), AUX RETURN, DIRECT OUT	Tip: Hot Sleeve: Ground	 <p>Phone Jack</p>

English

Deutsch

Français

Español

Italiano

Русский

中文

日本語

# Dimensional Diagram

IM8-40

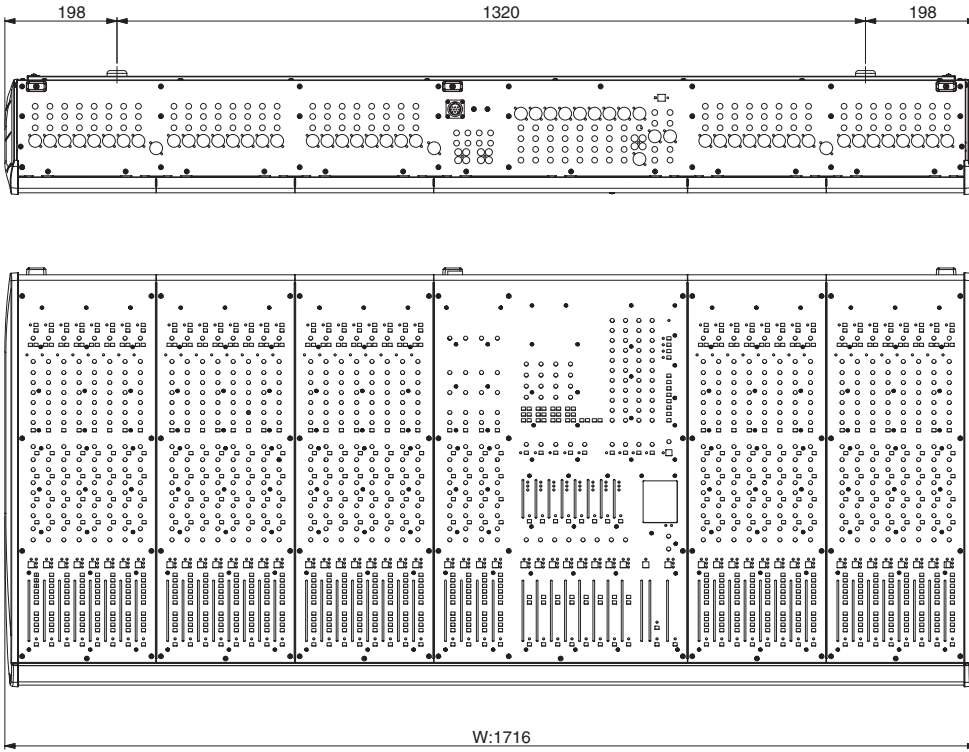

Units: mm

IM8-32

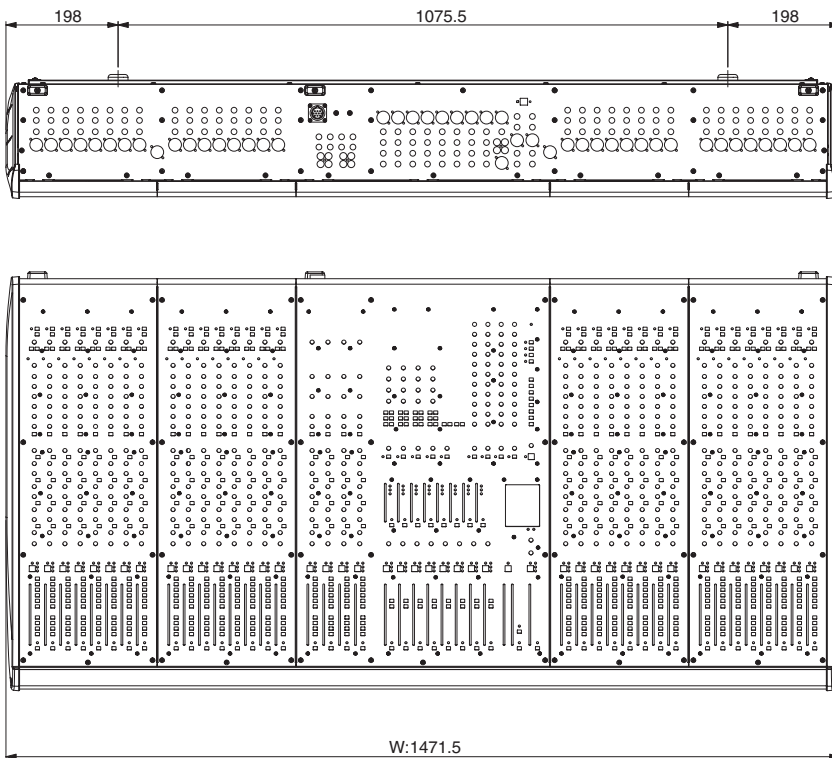

Units: mm

English

Deutsch

Français

Español

Italiano

Русский

中文

日本語

IM8-24

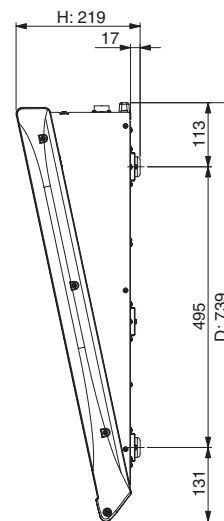
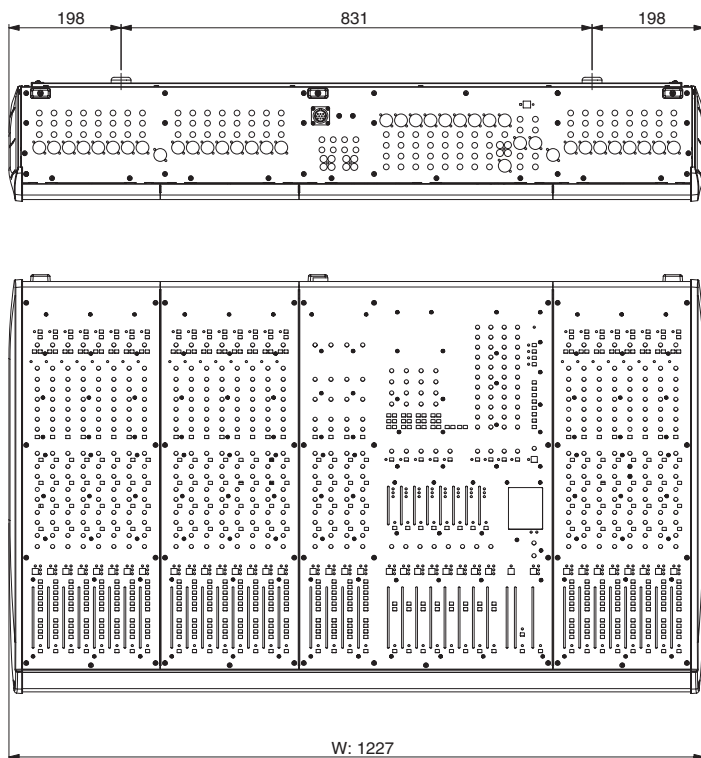

Units: mm

English

Deutsch

Français

Español

Italiano

Русский

中文

日本語

## Monaural Input

## Stereo Input



## STEREO INPUT

Session Information	
Title:	Notes:
Date:	
Place:	

STEREO AUX RETURN				2TR IN/ USB	REC OUT/ USB	MATRIX OUT				POWER
1	2	3	4			GROUP 1	GROUP 2	GROUP 3	GROUP 4	<input type="radio"/>
AUX 1-4 (4x4 grid of knobs)						MATRIX 1-4 (4x4 grid of knobs)				<b>MUTE MASTER</b> <input type="radio"/> 1 <input type="radio"/> 2 <input type="radio"/> 3 <input type="radio"/> 4
RETURN 1-4 (4x1 grid of knobs)				2TR IN/ <input type="checkbox"/> ST <input type="checkbox"/> MONO	REC OUT/ <input type="checkbox"/> ST <input type="checkbox"/> MONO	MATRIX 1-4 (4x1 grid of knobs)				<b>TALKBACK</b> <input type="checkbox"/> AUX 1-2 <input type="checkbox"/> AUX 3-4 <input type="checkbox"/> AUX 5-6 <input type="checkbox"/> AUX 7-8 <input type="checkbox"/> GROUP 1-8 <input type="checkbox"/> STEREO/MONO <input type="checkbox"/> MATRIX 1-2 <input type="checkbox"/> MATRIX 3-4
PFL (4x1 grid of buttons)						AFL (4x1 grid of buttons)				<b>TALKBACK LEVEL</b> <input type="radio"/> ON

AUX SEND							
1	2	3	4	5	6	7	8
PEAK meters (0 to 10) and AFL buttons							
PAN (L-R) knobs							
PEAK meters (0 to 20) and AFL buttons							
STEREO/MONO (ST/MONO) buttons							
PEAK meters (0 to 60) and AFL buttons							
<b>GROUP OUT</b> 1 2 3 4 5 6 7 8							

STEREO	MONITOR
PEAK meters (0 to 10) and AFL buttons	
PFL <input type="radio"/> AFL <input type="radio"/>	
MONITOR <input type="radio"/> PHONES <input type="radio"/>	
PEAK meters (0 to 20) and AFL buttons	
L R	
<b>STEREO MONO</b> 2TR IN <input type="radio"/> PHONES <input type="radio"/>	

# Block Diagram and Level Diagram

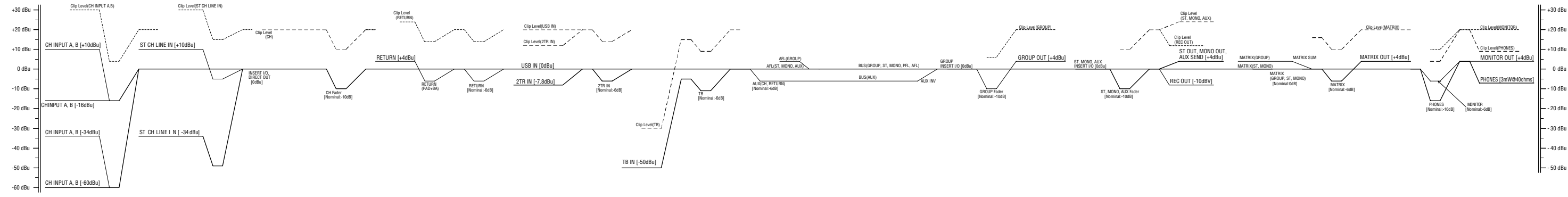
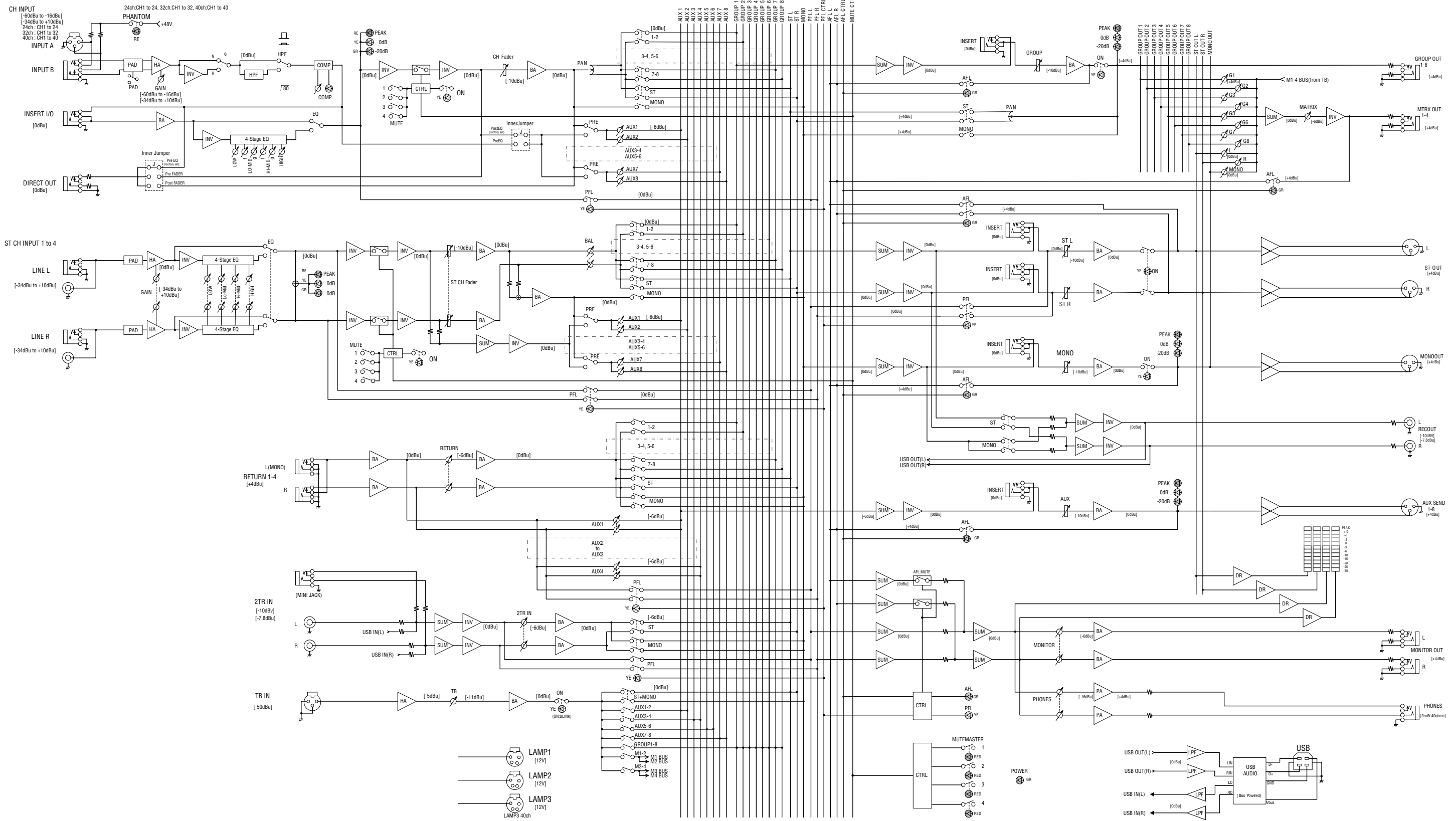



For details of products, please contact your nearest Yamaha representative or the authorized distributor listed below.

## NORTH AMERICA

### CANADA

**Yamaha Canada Music Ltd.**  
135 Milner Avenue, Scarborough, Ontario,  
M1S 3R1, Canada  
Tel: 416-298-1311

### U.S.A.

**Yamaha Corporation of America**  
6600 Orangethorpe Ave., Buena Park, Calif. 90620,  
U.S.A.  
Tel: 714-522-9011

## CENTRAL & SOUTH AMERICA

### MEXICO

**Yamaha de México S.A. de C.V.**  
Calz. Javier Rojo Gómez #1149,  
Col. Guadalupe del Moral  
C.P. 09300, México, D.F., México  
Tel: 55-5804-0600

### BRAZIL

**Yamaha Musical do Brasil Ltda.**  
Rua Joaquim Floriano, 913 - 4º andar, Itaim Bibi,  
CEP 04534-013 Sao Paulo, SP. BRAZIL  
Tel: 011-3704-1377

### ARGENTINA

**Yamaha Music Latin America, S.A.**  
**Sucursal de Argentina**  
Olga Cossettini 1553, Piso 4 Norte  
Madero Este-C1107CEK  
Buenos Aires, Argentina  
Tel: 011-4119-7000

### PANAMA AND OTHER LATIN AMERICAN COUNTRIES/ CARIBBEAN COUNTRIES

**Yamaha Music Latin America, S.A.**  
Torre Banco General, Piso 7, Urbanización Marbella,  
Calle 47 y Aquilino de la Guardia,  
Ciudad de Panamá, Panamá  
Tel: +507-269-5311

## EUROPE

### THE UNITED KINGDOM

**Yamaha Music U.K. Ltd.**  
Sherbourne Drive, Tilbrook, Milton Keynes,  
MK7 8BL, England  
Tel: 01908-366700

### GERMANY

**Yamaha Music Central Europe GmbH**  
Siemensstraße 22-34, 25462 Rellingen, Germany  
Tel: 04101-3030

### SWITZERLAND/LIECHTENSTEIN

**Yamaha Music Central Europe GmbH,**  
**Branch Switzerland**  
Seefeldstrasse 94, 8008 Zürich, Switzerland  
Tel: 01-383 3990

### AUSTRIA

**Yamaha Music Central Europe GmbH,**  
**Branch Austria**  
Schleiergasse 20, A-1100 Wien, Austria  
Tel: 01-60203900

### CZECH REPUBLIC/SLOVAKIA/ HUNGARY/SLOVENIA

**Yamaha Music Central Europe GmbH,**  
**Branch Austria, CEE Department**  
Schleiergasse 20, A-1100 Wien, Austria  
Tel: 01-602039025

### POLAND

**Yamaha Music Central Europe GmbH**  
**Sp.z. o.o. Oddział w Polsce**  
ul. 17 Stycznia 56, PL-02-146 Warszawa, Poland  
Tel: 022-868-07-57

### THE NETHERLANDS/ BELGIUM/LUXEMBOURG

**Yamaha Music Central Europe GmbH,**  
**Branch Benelux**  
Clarissenhof 5-b, 4133 AB Vianen, The Netherlands  
Tel: 0347-358 040

### FRANCE

**Yamaha Musique France**  
BP 70-77312 Marne-la-Vallée Cedex 2, France  
Tel: 01-64-61-4000

### ITALY

**Yamaha Musica Italia S.P.A.**  
**Combo Division**  
Viale Italia 88, 20020 Lainate (Milano), Italy  
Tel: 02-935-771

### SPAIN/PORTUGAL

**Yamaha Música Ibérica, S.A.**  
Ctra. de la Coruna km. 17, 200, 28230  
Las Rozas (Madrid), Spain  
Tel: 91-639-8888

### SWEDEN

**Yamaha Scandinavia AB**  
J. A. Wettergrens Gata 1, Box 30053  
S-400 43 Göteborg, Sweden  
Tel: 031 89 34 00

### DENMARK

**YS Copenhagen Liaison Office**  
Generatorvej 6A, DK-2730 Herlev, Denmark  
Tel: 44 92 49 00

### NORWAY

**Norsk filial av Yamaha Scandinavia AB**  
Grini Næringspark 1, N-1345 Østerås, Norway  
Tel: 67 16 77 70

### RUSSIA

**Yamaha Music (Russia)**  
Office 4015, entrance 2, 21/5 Kuznetskii  
Most street, Moscow, 107996, Russia  
Tel: 495 626 0660

### OTHER EUROPEAN COUNTRIES

**Yamaha Music Central Europe GmbH**  
Siemensstraße 22-34, 25462 Rellingen, Germany  
Tel: +49-4101-3030

## AFRICA

**Yamaha Corporation,**  
**Asia-Pacific Music Marketing Group**  
Nakazawa-cho 10-1, Naka-ku, Hamamatsu,  
Japan 430-8650  
Tel: +81-53-460-2313

## MIDDLE EAST

### TURKEY/CYPRUS

**Yamaha Music Central Europe GmbH**  
Siemensstraße 22-34, 25462 Rellingen, Germany  
Tel: 04101-3030

### OTHER COUNTRIES

**Yamaha Music Gulf FZE**  
LOB 16-513, P.O.Box 17328, Jubel Ali,  
Dubai, United Arab Emirates  
Tel: +971-4-881-5868

## ASIA

### THE PEOPLE'S REPUBLIC OF CHINA

**Yamaha Music & Electronics (China) Co.,Ltd.**  
25/F., United Plaza, 1468 Nanjing Road (West),  
Jingan, Shanghai, China  
Tel: 021-6247-2211

### INDONESIA

**PT. Yamaha Music Indonesia (Distributor)**  
**PT. Nusantik**  
Gedung Yamaha Music Center, Jalan Jend. Gatot  
Subroto Kav. 4, Jakarta 12930, Indonesia  
Tel: 21-520-2577

### KOREA

**Yamaha Music Korea Ltd.**  
8F, 9F, Dongsung Bldg. 158-9 Samsung-Dong,  
Kangnam-Gu, Seoul, Korea  
Tel: 080-004-0022

### MALAYSIA

**Yamaha Music Malaysia, Sdn., Bhd.**  
Lot 8, Jalan Perbandaran, 47301 Kelana Jaya,  
Petaling Jaya, Selangor, Malaysia  
Tel: 3-78030900

### SINGAPORE

**Yamaha Music Asia Pte., Ltd.**  
#03-11 A-Z Building  
140 Paya Lebar Road, Singapore 409015  
Tel: 747-4374

### TAIWAN

**Yamaha KHS Music Co., Ltd.**  
3F, #6, Sec.2, Nan Jing E. Rd. Taipei.  
Taiwan 104, R.O.C.  
Tel: 02-2511-8688

### THAILAND

**Siam Music Yamaha Co., Ltd.**  
891/1 Siam Motors Building, 15-16 floor  
Rama 1 road, Wangmai, Pathumwan  
Bangkok 10330, Thailand  
Tel: 02-215-2626

### OTHER ASIAN COUNTRIES

**Yamaha Corporation,**  
**Asia-Pacific Music Marketing Group**  
Nakazawa-cho 10-1, Naka-ku, Hamamatsu,  
Japan 430-8650  
Tel: +81-53-460-2317

## OCEANIA

### AUSTRALIA

**Yamaha Music Australia Pty. Ltd.**  
Level 1, 99 Queensbridge Street, Southbank,  
Victoria 3006, Australia  
Tel: 3-9693-5111

### COUNTRIES AND TRUST TERRITORIES IN PACIFIC OCEAN

**Yamaha Corporation,**  
**Asia-Pacific Music Marketing Group**  
Nakazawa-cho 10-1, Naka-ku, Hamamatsu,  
Japan 430-8650  
Tel: +81-53-460-2313

**HEAD OFFICE** Yamaha Corporation, Pro Audio & Digital Musical Instrument Division  
Nakazawa-cho 10-1, Naka-ku, Hamamatsu, Japan 430-8650  
Tel: +81-53-460-2441



Yamaha Pro Audio global web site:  
<http://www.yamahaproaudio.com/>

Yamaha Manual Library  
<http://www.yamaha.co.jp/manual/>

U.R.G., Pro Audio & Digital Musical Instrument Division, Yamaha Corporation  
©2008 Yamaha Corporation

WN16170 805 IPDHx.x-01A0  
Printed in Japan