



USB Audio Interface

ZG02

User Guide

EN

Contents

Introduction	4
About this manual	4
Notes regarding the use of this product	5
Product features	6
Accessories	7
Component names and functions	8
Front side	8
Rear panel	9
Operating panel	10
Connections	12
Basic connections	12
Connection example	14
Installing the dedicated software	16
About the “Yamaha ZG Controller” app	16
Installing the software (Windows)	18
Installing the software (Mac)	19
Making settings on the computer	20
Configuring the playback/recording device on the computer	20
Surround settings on the computer	21
Operations	22
Basic operations	22
Adding effects to the mic audio	26
Adding effects to game and voice chat audio	27
Audio settings for livestreaming	28

Troubleshooting **29**

Power-related 29

Audio-related 30

Restoring the factory default settings (factory reset) 32

Firmware update 33

Appendix **34**

Trademarks 34

General specifications 35

Block diagram 36

Introduction

About this manual

Thank you for purchasing this Yamaha product. The ZG02 is a game streaming mixer that can be used to mix the audio playback from a game or a voice chat and output the mix for livestreaming, just by connecting your computer and gaming device.

How the manuals are organized

The manuals that cover the ZG02 are listed below.

- **Safety Guide** (included with this product)
Lists the safety-related points you need to be aware of when using this product. Be sure to read through this information before using the product, so that you use this product correctly and safely.
- **Start Guide** (included with this product)
Explains in illustrated form about the connections you need to make when you first use this product.
- **User Guide** (this guide)
Explains all of the functions, such as information that is not explained in the Start Guide. The precautions and other matters of concern are classified in this guide as follows.



WARNING

This content indicates “risk of serious injury or death.”



CAUTION

This content indicates “risk of injury.”

NOTICE

Matters that must be observed to avoid product breakdown, damage or malfunction, as well as to prevent the loss of data and to protect the environment.

NOTE

Points of note when using this product, limitations in functionality, and supplementary information that's useful to know.

- All of the illustrations and screenshots in this guide are provided for the purpose of explanation.
- Keep the manuals included with this product in a place where you can refer to them whenever needed. You can also download these manuals from the Yamaha website, so please make use of these resources as necessary.
<https://download.yamaha.com/>

Notes regarding the use of this product

Please take note of the following points when using the ZG02.

Protection of copyright

- Do not use this product for any purpose that may infringe upon the rights of any third party including copyrights, as established by law in each country or region.
- Yamaha bears no responsibility for any infringement upon third party rights that may occur as a result of using this product.

Product features

The ZG02 offers the following features.

■ Connectivity over USB with gaming devices

This unit features two USB ports, one for connecting to a computer and the other for connecting to a console (gaming device), so that you can enjoy listening to the game audio with both devices connected via USB cable.

■ USB bus power

This unit can be powered by connecting your computer to the [USB (PC)] port on this unit via USB cable.
* See the USB-related specifications in ❶ [USB (PC) port] (USB Type-C™) on “Rear panel” (p.9).

■ Voice chat support

It's easy to create a setup for voice chat by connecting this unit to a computer (Windows/Mac) on which voice chat software is installed.

■ Livestreaming support

You can mix the game audio with audio from a mic or voice chat, and output the result to a computer connected via USB.

■ Voice change and game sound effect features

You can use the voice change feature to add echo to the mic audio, output a censorship tone (beep), and process the audio. Further, you can use the game sound effect feature to set sound effects that are appropriate for the game.

■ “Yamaha ZG Controller” dedicated application

After you've installed “Yamaha ZG Controller” on your computer (Windows/Mac), you'll be able to control more detailed settings on the ZG02, such as checking and setting the mic audio level, adjusting the effects for the voice chat and game audio, registering effect presets, setting the monitor audio and more.

Accessories

The following accessories are included with the ZG02.

- USB 2.0 cable (Type A-Type C), 1.5 m × 1

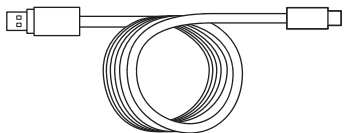

- Start Guide × 1
- Safety Guide × 1

Component names and functions

Front side

The following explains the names and functions of each component on the front of this unit.

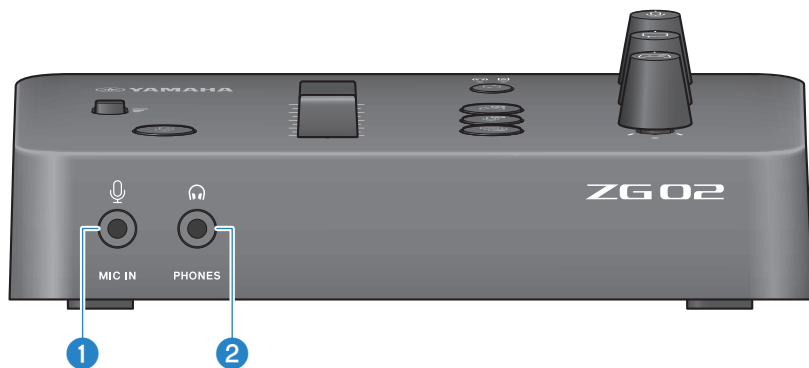

1 [MIC IN] jack

Connect your mic here (3.5 mm mini-plug; plug-in power supported).

NOTE

Connect to the [MIC IN] jack on either the front or the rear panel. If a mic is connected to both jacks, the front [MIC IN] jack will be given priority.

2 [PHONES] jack

Connect your headphones here (3.5 mm stereo mini-plug).

Rear panel

The following explains the names and functions of each component on the rear panel of this unit.

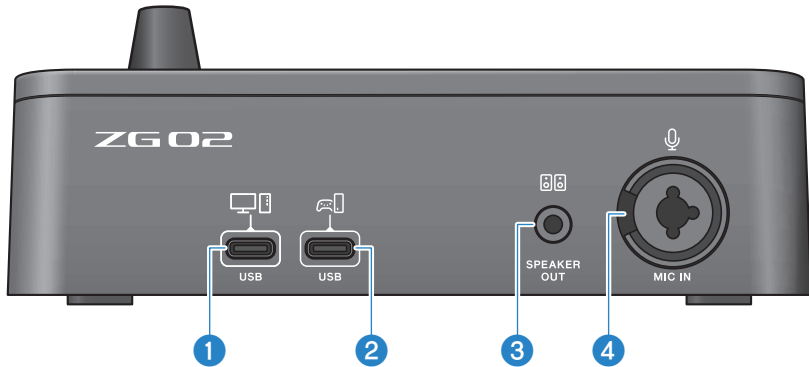

1 [USB (PC)] port (USB Type-C™)

This is a dedicated Type-C USB port for connecting this unit to a computer.

- * Requires a 5 V/900 mA power supply
- * USB 2.0/High-Speed supported

2 [USB (CONSOLE)] port (USB Type-C™)

This is a dedicated Type-C USB port for connecting this unit to your console (home gaming device).

- * USB 2.0/Full-Speed supported

Follow the important precautions below to prevent device malfunctions or loss of data.

NOTICE

- Do not connect any other devices except for your computer to the [USB (PC)] port.
- Do not connect any other devices except for your gaming device to the [USB (CONSOLE)] port.
- Use a Type-C USB cable that's less than three meters long to connect your devices.
- Before inserting or unplugging the USB cable, quit all applications.
- After you unplug the cable, make sure to wait for at least six seconds before plugging the cable in again. Rapidly plugging in and unplugging the cable may cause a malfunction.

3 [SPEAKER OUT] jack

Connect your powered speakers here (3.5 mm stereo mini-plug).

4 [MIC IN] jack

Connect a mic here (either XLR or a TRS phone jack).

NOTE

Connect to the [MIC IN] jack on either the front or the rear panel of this unit. If a mic is connected to both jacks, the front [MIC IN] jack will be given priority.

Operating panel

The following explains the names and functions of each component on the operating panel.

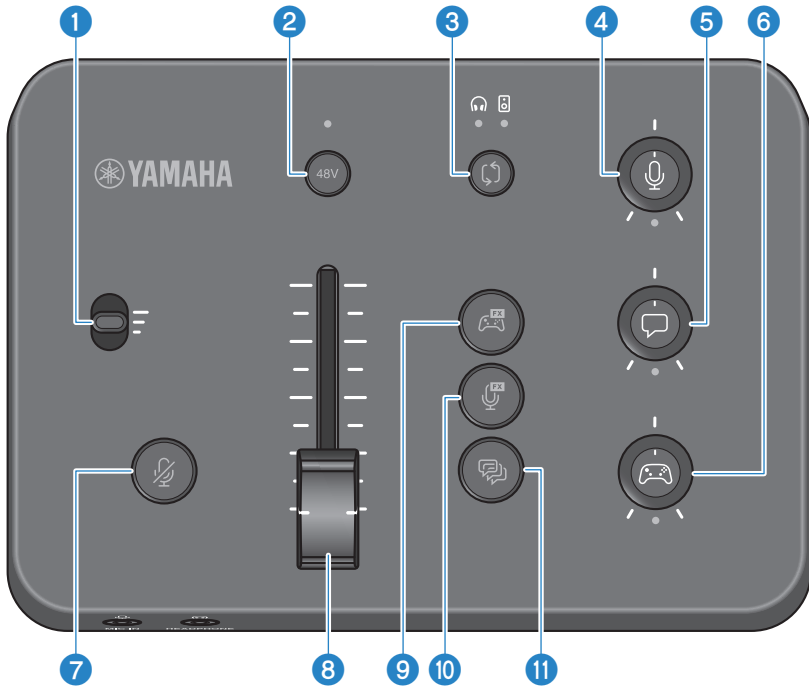

1 Mic gain switch

Sets the base level of the mic input (in three stages).

2 Phantom [48V] button/LED

Switches the phantom power on/off. Hold down the button to toggle between on and off. When the button is on, DC +48 V phantom power is supplied to your mic connected to the [MIC IN] jack on the rear panel with an XLR plug, and the LED lights up. Turn this on when you are using a condenser mic that supports phantom power.

Precautions regarding phantom power

- Follow the important precautions below, in order to prevent noise and possible damage to this unit or to any external devices.
 - Turn phantom power off when you don't need it.
 - Leave this off when you connect a device that does not support phantom power to the [MIC IN] jack on the rear panel.
 - Do not connect/disconnect a cable to or from the [MIC IN] jack on the rear panel while this switch is on.
 - Before turning this on/off, turn the 7 mic mute [M] button on.

3 Monitor select [🔊] button/LED

Switches the output destination (headphones or speakers) of the monitor audio. The LED of the selected output lights up.



WARNING

- Adjust the volume of your connected devices before you change the output destination. This is because the levels may suddenly get loud depending on the device you've connected, which could damage your hearing or cause external devices to malfunction.

4 Mic monitor level [🔊] knob

Adjusts the monitor volume of the mic audio.

5 Voice chat level [💬] knob

Adjusts the audio volume of the other party in the chat.

6 Game sound level [🎮] knob

Adjusts the audio volume of the game.

You can also use this knob to adjust the audio from a computer that is connected via USB.

NOTE

- The LED below the knob lights up when streaming level link is ON.
- The monitor volumes of the signals for the respective **4**, **5** and **6** knobs are used for the streaming volume while streaming level link is ON. (p.28)

7 Mic mute [🔇] button

Mutes the mic audio. The button lights when the audio is muted.

8 Mic level (fader)

Adjusts the output level of the mic audio.

9 Game effect [🎮] button

Recalls the game effect that you've registered beforehand, and toggles it ON/OFF each time you press the button. (p.27)

10 Mic effect [🔊] button

Recalls the mic effect that you've registered beforehand, and toggles it ON/OFF each time you press the button. (p.26)

11 Echo [🗣️] button

Adds echo to the mic audio. (p.26)

Connections

Basic connections

This example shows how to make connections to enjoy voice chats while playing a game, by using a voice chat app for your computer. You can play the game's audio using the ZG02, either from your home gaming device connected via USB or from your computer connected via USB.

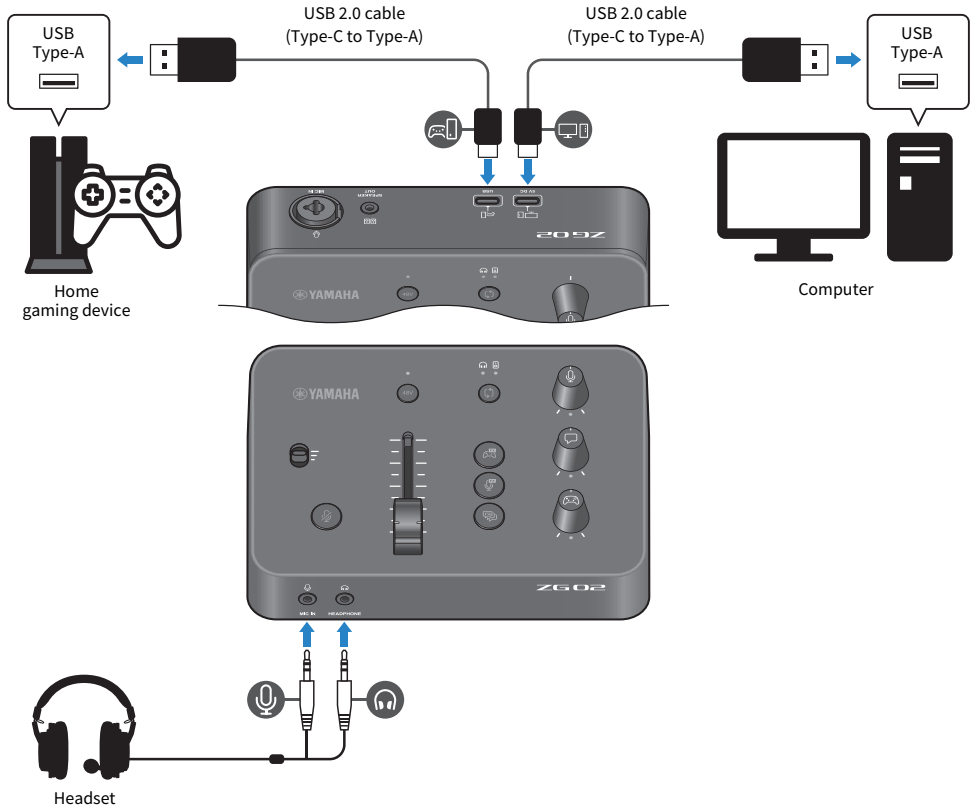

What you need

- Home gaming device that supports USB output
- Commercially available USB 2.0 cable (Type-C to Type-A)
- Computer
- Included USB 2.0 cable (Type-C to Type-A)



- Headset (with analog connection)

When using a headset that has a TRRS (4-conductor) stereo mini plug, you'll need an audio cable that splits off into a mic plug and a headphones plug.

Connecting



- Connect the [USB (CONSOLE) 

NOTE

- For the USB cable that's connected to the USB  CONSOLE port, use a USB 2.0 cable (Type-C to Type-A) that's less than three meters long.
- You will need to install the Yamaha ZG Controller on your computer for this. (p.16)
- The [USB (PC) 

13

Connecting

- Connect the [USB (CONSOLE) - Connect the [USB (PC) - Connect the condenser mic to the [MIC IN] jack on the rear panel.
- Connect your headphones to the [PHONES] jack.

Protection of copyright

Observe the following precautions when distributing content via livestreaming.

- Do not use this product for any purpose that may infringe upon the rights of any third party including copyrights, as established by law in each country or region.
- Yamaha bears no responsibility for any infringement upon third party rights that may occur as a result of using this product.

NOTE

- When connecting a condenser mic, make sure that the ZG02 is turned on, and hold down the phantom [48V] button to turn phantom power on. (p.10)
- Do not connect anything to the [MIC IN] jack on the front panel when you have already connected a mic to the [MIC IN] jack on the rear panel. If mics are connected to both jacks, the [MIC IN] jack on the front panel will be given priority.
- You will need to install the Yamaha ZG Controller on your computer for this. (p.16)
- The [USB (PC) - If your computer or home gaming device uses a Type-C USB port, use a commercially available Type-C cable (Type-C to Type-C) to connect.

Installing the dedicated software

About the “Yamaha ZG Controller” app

The “Yamaha ZG Controller” is an app that’s used to configure and control the ZG02. You can use this to adjust the mic and monitor audio on the ZG02, make settings for voice effects and game effects, update the firmware and so on.

■ How to install the “Yamaha ZG Controller”

Download the “TOOLS for ZG” software package from the Yamaha website and install on your computer. “TOOLS for ZG” includes the following application and driver.

- Yamaha ZG Controller: an application used to configure and control the ZG02.
- Yamaha Steinberg USB Driver: a USB driver that allows your computer to recognize the ZG02.

NOTE

The use of this software requires your consent to the “Terms of Use” that are shown during installation.

■ Starting up “Yamaha ZG Controller”

Refer to the operating guide to learn how to use each of the features and change the display language.

Operating guide

Click the “?” icon in the top-right corner of the screen to show the operating guide.

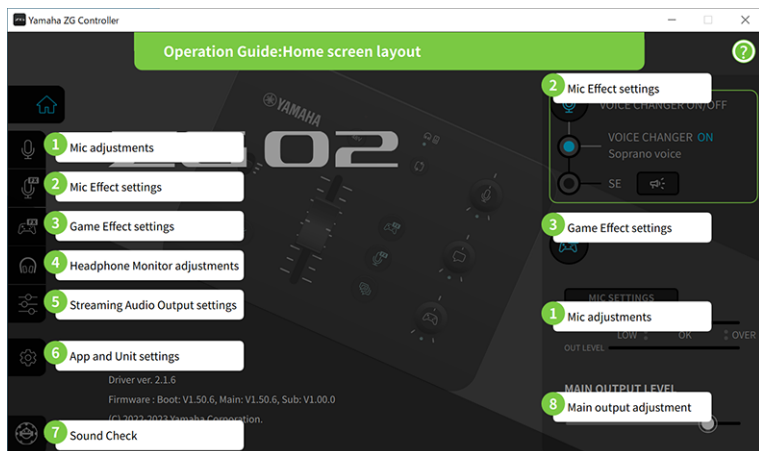

Installing the dedicated software > About the “Yamaha ZG Controller” app

Switching between languages

You can switch between language used in the operating guide and in the tips (the guidance shown for the buttons and other controls) with the “LANGUAGE” parameter on the “SETTINGS (APPLICATION)” screen. The software language changes to English, Japanese or Chinese automatically when the software is first launched, based on the OS language settings.

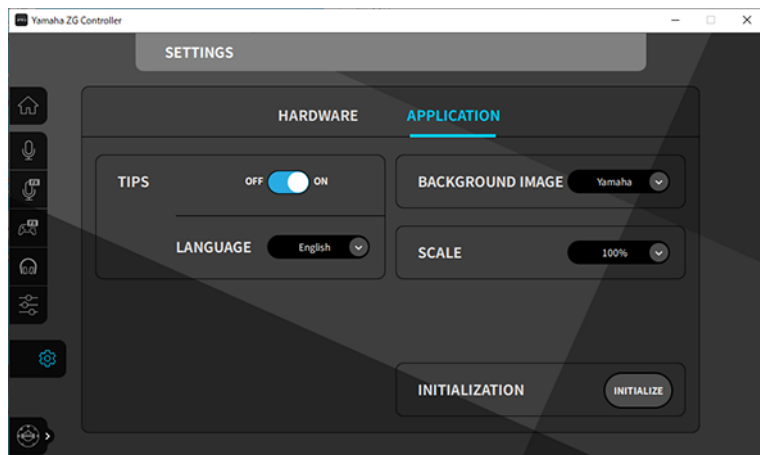

Related links

- “Installing the software (Windows)” (p.18)
- “Installing the software (Mac)” (p.19)

Installing the software (Windows)

This explains how to install the “TOOLS for ZG” software package on your Windows computer. “TOOLS for ZG” includes the “Yamaha ZG Controller” application and “Yamaha Steinberg USB Driver” driver.

■ Installing

Follow the steps below to install. Connect the ZG02 to your Windows computer after the installation is finished.

1 Access the following website to download “TOOLS for ZG”.

<https://www.yamaha.com/2/zg02/>

2 Expand (decompress) the downloaded file and run the “Install_ZG.exe” file.

If you don't have administrator privileges, follow the messages shown to execute the file using administrator privileges.

3 Follow the onscreen instructions to install.

When a screen appears prompting you to restart, follow the instructions to restart your computer.

Now you've installed “TOOLS for ZG”.

Connect the ZG02 to your Windows computer with the included USB 2.0 cable.

■ Uninstalling

Follow these steps to uninstall the application and driver.

1 From “Settings” on your Windows computer, open “Apps & features”.

2 Select “Yamaha ZG Controller” or “Yamaha Steinberg USB Driver” from the list of installed programs, and press “Uninstall”.

Install “Yamaha ZG Controller” and “Yamaha Steinberg USB Driver” separately.

3 Follow the onscreen instructions to uninstall.

When a screen appears prompting you to restart, follow the instructions to restart your computer.

Installing the software (Mac)

This explains how to install the “TOOLS for ZG” software on your Mac. “TOOLS for ZG” includes the “Yamaha ZG Controller” application, the “Yamaha Steinberg USB Driver” driver and the respective uninstallers.

■ Installing

Follow the steps below to install. Connect the ZG02 to your Mac after the installation is finished.

1 Access the following website to download “TOOLS for ZG”.

<https://www.yamaha.com/2/zg02/>

NOTE

The steps for installation are different for Macs with Apple silicon. For details, see the explanation shown on the website listed above.

2 Expand (decompress) the downloaded file and run the “TOOLS for ZG V*.pkg” file.**

If you don't have administrator privileges, follow the messages shown to log into an account with administrator privileges in order to execute the file.

NOTE

The apps for uninstalling (“Uninstall Yamaha ZG Application” and “Uninstall Yamaha Steinberg USB Driver”) are included with the downloaded file. You'll need these files when uninstalling.

3 Follow the onscreen instructions to install.

When a screen appears prompting you to restart, follow the instructions to restart your Mac.

Now you've installed “TOOLS for ZG”.

Connect the ZG02 to your Mac with the included USB 2.0 cable.

■ Uninstalling

Follow these steps to uninstall the application and driver.

1 Run the “Uninstall Yamaha ZG Application” and “Uninstall Yamaha Steinberg USB Driver” respectively.

Making settings on the computer

Configuring the playback/recording device on the computer

After installing “TOOLS for ZG”, configure the settings for the playback/recording device (input and output device) on your computer.

Playback/recording devices

The ZG02 will recognize your computer as a playback and recording device, as follows.

Device type	Device name	Explanation
Playback device	Windows: Speakers (Yamaha ZG02) Mac: Yamaha ZG02 Game	Select this to output the audio from the computer (such as the audio from a game or other app, of the system sounds) to the ZG02.
Playback device	Windows: Voice (Yamaha ZG02) Mac: Yamaha ZG02 Voice	Select this to output the voice chat audio to the ZG02.
Recording device	Windows: Streaming (Yamaha ZG02) Mac: Yamaha ZG02 Game	Select this to input the streaming audio that is mixed on the ZG02 to your computer.
Recording device	Windows: Voice (Yamaha ZG02) Mac: Yamaha ZG02 Voice	Select this to input the mic audio from the ZG02 to your computer.

Settings for playing back audio from the computer (such as the audio from a game or other app) to the ZG02

Configure the playback device for the computer as follows.

Playback device
Windows: Speakers (Yamaha ZG02) Mac: Yamaha ZG02 Game

Device settings for the voice chat app

From the audio settings on your voice chat app, set the input and output device as follows.

Input device	Output device
Windows: Voice (Yamaha ZG02) Mac: Yamaha ZG02 Voice	Windows: Voice (Yamaha ZG02) Mac: Yamaha ZG02 Voice

Device settings for livestreaming app

From the audio settings on your livestreaming app, set the input device as follows.

Input device
Windows: Streaming (Yamaha ZG02) Mac: Yamaha ZG02 Game

Surround settings on the computer

To configure the audio on your Windows computer to play back in surround sound with the ZG02, edit the sound output settings on your computer.

On the Mac, this is configured automatically by following the channel format of the application being used.

Enabling 7.1 ch surround playback on Windows

- 1 From the Windows Start button, open “Settings”, and then go to “System” > “Sounds”.**
- 2 Open the “Sound control panel”.**
For Windows 10: select “Sound control panel”.
For Windows 11: select “More sound settings”.
- 3 Select “Speakers (Yamaha ZG02)” in the “Playback” tab, and click the “Configure” button.**
The configuration selection screen appears.
- 4 In “Audio channels”, select “7.1 Surround”.**
- 5 Select all checkboxes for “Optional speakers”.**
- 6 Select all checkboxes for “Full-range speakers”.**
- 7 Click “Finish.”**

NOTE

The setting method may differ depending on the OS version.

Operations

Basic operations

This explains the basic operations for holding a voice chat while playing back the audio from a game. This shows how to operate the unit when connected in the following way.

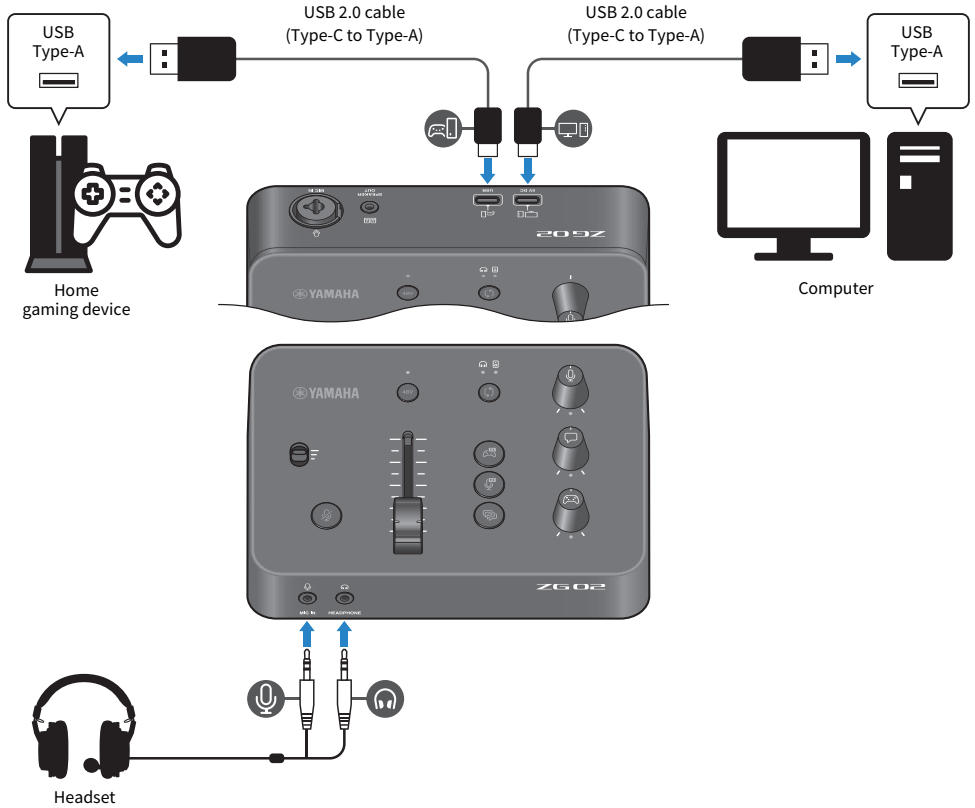

1 Before turning on the power, turn the following knobs all the way down:

Mic gain switch, mic level (fader), mic monitor level [🔊], voice chat level [🗨️], game sound level [🎮]

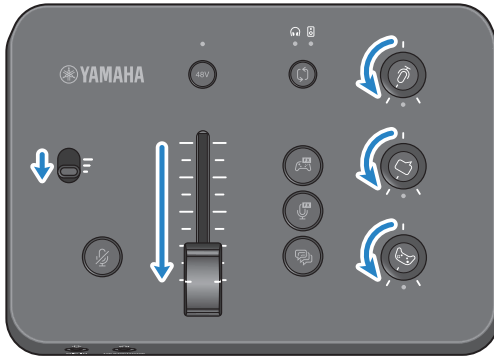

2 Start up the computer.

Install “TOOLS for ZG” on your computer beforehand.

3 Turn on the ZG02.

Connect the USB [PC] port to your computer with a USB 2.0 cable (Type-C to Type-A).

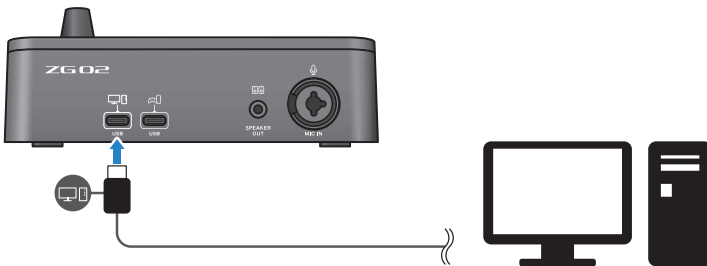

NOTE

- After you unplug the USB cable, make sure to wait for at least six seconds before plugging the cable in again. Rapidly plugging in and unplugging the USB cable may cause a malfunction.
- This unit can also be powered via the USB (CONSOLE) port. If the power supply is insufficient, use the USB (PC) to supply power to this unit.

4 Select the audio monitor destination.

Press the monitor select [] button while checking the LED indicator. In this example, we've selected the headphones.



5 Adjust the input and output levels for the mic audio.

Turn each knob to the positions shown in the figure, and vocalize into your mic. Adjust the mic audio input level with the mic gain switch, and adjust the mic audio output level with the mic level (fader) so that the levels are appropriate when you're listening through headphones.

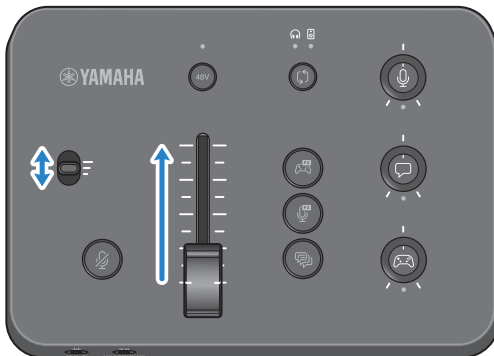

You can use Yamaha ZG Controller to check the mic input/output levels. Adjust the input level (MIC LEVEL) and output level (OUT LEVEL) while checking the level meters on the “MIC SETTINGS” screen, so that the levels are within the “OK” range.



6 Adjust the monitor volume for the mic, voice chat and game.

While inputting audio from the mic, voice chat and gaming device, use the mic monitor level knob [🎤], the voice chat level [🗨️] knob and the game sound level [🎮] knob to adjust the respective monitor volumes and balance.

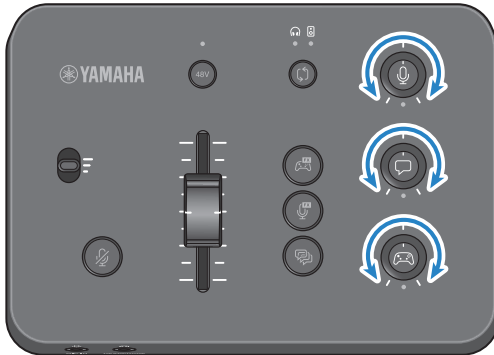

The mic audio is output only through the headphones, and is not output through the speakers ([SPEAKER OUT] jack).



Adding effects to the mic audio

You can add a variety of effects to the mic audio.

The following types of effects are set by default for each mic effect button. You can adjust the parameters in detail for each effect from the MIC EFFECT screen of the “Yamaha ZG Controller” dedicated software.

Button	Function
	<p>VOICE CHANGER</p> <p>Changes the characteristics of the mic input audio. The default effect alters male voices to sound like female voices.</p> <p>Toggle between on/off with each press of the switch.</p>
MIC EFFECT	<p>SE</p> <p>This lets you output a censorship tone (electronic beep). This is on only while the button is pressed.</p> <p>Use “Yamaha ZG Controller” to switch between “VOICE CHANGER” and “SE”.</p>
	<p>ECHO</p> <p>Adds echo to the mic input audio.</p> <p>Echo is applied only while the button is pressed.</p>
ECHO	

Adding effects to game and voice chat audio

You can add a variety of effects to game audio and to voice chat audio.

On the GAME EFFECT screen in the “Yamaha ZG Controller”, you can edit the effects and adjust the detailed parameters.

Button	Function
	<p>Toggles the GAME EFFECT on/off.</p> <p>Use the “Yamaha ZG Controller” to configure the GAME EFFECT that’s assigned to this switch.</p> <p>The “Immersive” effect is assigned by default.</p>

GAME EFFECT

Audio settings for livestreaming

Configure the livestreaming audio settings and set the output destination for the livestreaming audio in the “STREAMING OUTPUT MIXER” screen of “Yamaha ZG Controller”.

- 1 Launch the “Yamaha ZG Controller” app.**
- 2 Open the “STREAMING OUTPUT MIXER” screen.**

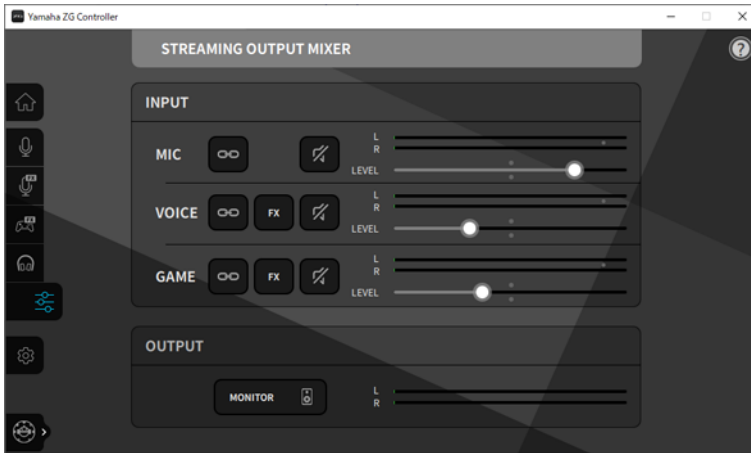

- 3 Set each of the INPUT parameters.**

Adjust the volume for MIC (microphone audio), VOICE (voice chat audio) and GAME (game audio). The audio signals you adjust here are output as livestreaming audio. By turning the streaming level link (🔊) on for each input, you can use the corresponding knobs on the panel to adjust the volumes. The LED below each knob lights up when the streaming level link (🔊) is on. Effects (FX) can be turned on/off as well for VOICE and GAME.

NOTE

- To listen to the output audio in headphones or through speakers, click “MONITOR” to turn it on.
- To monitor the audio through speakers or headphones, switch between the two by using the monitor select (🔊) button on the operating panel of the ZG02.

Troubleshooting

Power-related

The power does not turn on

● **Your computer may not be able to supply enough power to this unit.**

Connect the unit to a USB port that can supply at least 900 mA of power, or use the included Type C-Type C cable to connect to your computer.

● **The computer's power may be off.**

Turn on the computer.

● **The computer may be in standby, sleep or suspend mode.**

Enable USB power output on the computer in these cases.

● **You aren't using an appropriate USB cable when connecting via bus power.**

Be sure to connect a Type-C USB cable that's less than three meters long to your computer.

Audio-related

The mic audio can't be heard

- **The mic volume is not set properly,**

Adjust the mic audio input level using the mic gain switch while checking the “Yamaha ZG Controller” level meter (MIC LEVEL). Next, adjust the mic audio output level using the mic level (fader) while watching the level meter (OUT LEVEL).

- **The mic is muted.**

Press the mic mute [] button to unmute the mic.

The mic audio is clipping or exhibits a lot of noise

- **The mic volume is not set properly, or the various settings for the “Yamaha ZG Controller” mic effects have not been adjusted.**

Adjust the mic audio input level using the mic gain switch while checking the “Yamaha ZG Controller” level meter (MIC LEVEL). Next, adjust the mic audio output level using the mic level (fader) while watching the level meter (OUT LEVEL). Check the settings for the “Yamaha ZG Controller” mic effect as well.

No audio input from the mic connected to the [MIC IN] jack on the rear panel

- **A mic might be connected to the [MIC IN] jack on the front panel.**

Disconnect the mic from the [MIC IN] jack on the front panel. If mics are connected to both [MIC IN] jacks, the [MIC IN] jack on the front panel will be given priority.

- **Phantom power is not turned on.**

When connecting a condenser mic (with XLR plug) to the rear panel [MIC IN] jack, hold down the phantom [48V] button to turn the phantom power on.

The audio from the gaming device or computer connected to the USB jack cannot be heard

- **The output destination for the audio from the gaming device is not set to USB.**

Check the settings on the gaming device, and set the output to USB.

Cannot hear the voice chat audio

- **The audio output destination for the voice chat app is not set properly.**

In the voice chat app settings, select the “Voice (Yamaha ZG02)” audio output destination.

The other party in the voice chat can't hear the audio from the mic.

- **The audio input destination for the voice chat app is not set properly.**

In the voice chat app settings, select the “Voice (Yamaha ZG02)” audio input destination.

No sound is coming out of the headphones/speakers

● **The output destination for the monitor audio (speakers or headphones) is wrong.**

Press the monitor select [>] button to switch to the intended output destination.

Surround audio from a computer connected via USB cannot be input

● **The computer may not be configured for multichannel output.**

Configure your computer's "Surround settings on the computer" (p.21) for multichannel output.

NOTE

Also see the product information page for the ZG02.

<https://www.yamaha.com/2/zg02/>

Restoring the factory default settings (factory reset)

To reinitialize the ZG02, use the “Yamaha ZG Controller”. Once you initialize this product, all settings will be returned to their factory defaults. We recommend that you use the “BACKUP” function in the software to back up the settings before initializing.

- 1** Launch the “Yamaha ZG Controller” app.
- 2** Open the “SETTINGS (HARDWARE)” screen.
- 3** Click “INITIALIZE.”

After clicking, operate by following the instructions on the “Yamaha ZG Controller”.

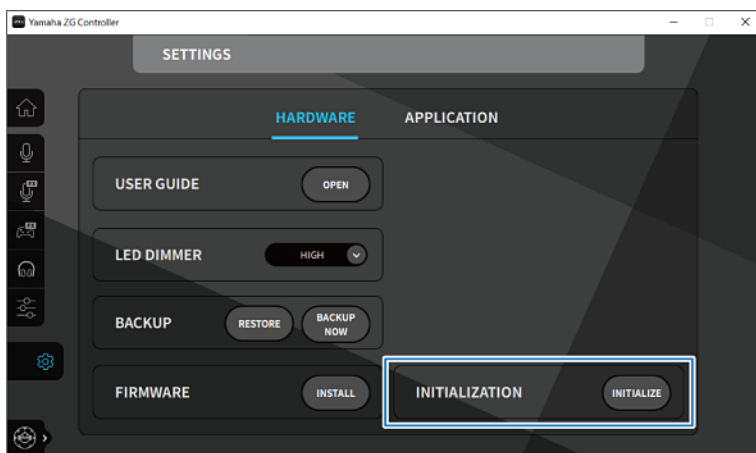

Firmware update

The firmware of the ZG02 may need to be updated as necessary to use added functionality and so on. See the Yamaha website for details on updating the firmware version.

Update the firmware by operating the “Yamaha ZG Controller”.

- 1 Launch the “Yamaha ZG Controller” app.**
- 2 Open the “SETTINGS (HARDWARE)” screen.**
- 3 Click “INSTALL.”**

After clicking, operate by following the instructions in the software.

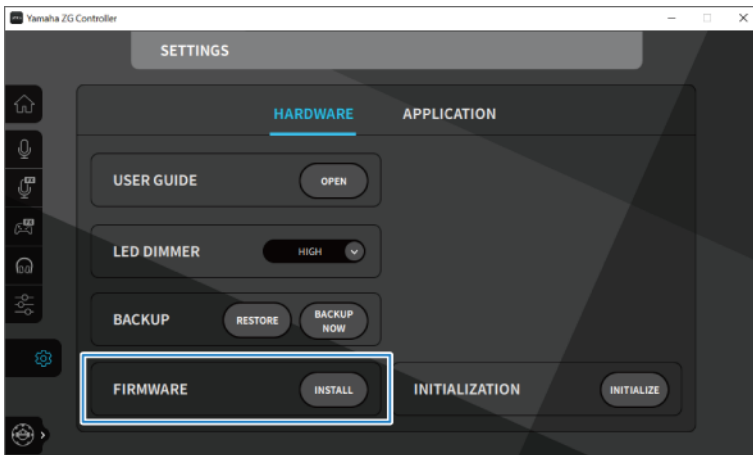

Appendix

Trademarks

USB Type-C™ and USB-C™ are trademarks of USB Implementers Forum.

Windows is a trademark or registered trademark of Microsoft Corporation in the United States, Japan and other countries.

Apple, Mac and macOS are trademarks of Apple Inc. registered in the United States and other countries.

Any company names, product names or related names in this document are the registered trademarks or trademarks of their respective owners.

General specifications

General specifications

Power Requirements	DC 5 V, 900 mA
Power Consumption	Max. 4.5 W
Dimensions (W×H×D)	162 mm (W) × 61 mm (H) × 113 mm (D)
Net Weight	0.6 kg (1.32 lbs.)
Included Accessory	USB2.0 A to C CABLE (1.5 m) × 1, Start Guide × 1, Safety Guide × 1
Operating Temperature	0 to +40°C

* 0 dBu is referenced to 0.775 Vrms, 0 dBV is referenced to 1 Vrms.

Analog input characteristics

Input Terminals	PAD	GAIN SW	Actual Load Impedance	For Use With Nominal	Input Level	Jack	Balanced / Unbalanced
					Max. before clip		
MIC IN (TRS) MIC IN (COMBO)	-	+50 dB	1.5 kΩ (TRS) 3.3 kΩ (COMBO)	1.6 kΩ (TRS) 50~600 Ω (Combo)	-38 dBu (9.76 mV)	TRS (3.5 mm) Combo *1	Unbalanced (TRS) Balanced (Combo)
		+35 dB			-23 dBu (54.87 mV)		
		+20 dB	-8 dBu (308.50 mV)				

*1 XLR: 1=GND, 2=HOT, 3=COLD, TRS: Tip=HOT, Ring=COLD, Sleeve=GND

* All A/D converters work with 24-bit bit depth and 48-kHz sampling.

* +48 V DC (phantom power) is supplied to MIC INPUT XLR type connector.

Analog output characteristics

Output Terminals	Actual Source Impedance	For Use With Nominal	GAIN SW	Output level	Jack	Balanced / Unbalanced
				Max. Before Clip		
PHONES OUT	88 Ω	40 Ω	-	6 mW	TRS (3.5 mm) *1	Unbalanced
SPEAKER OUT	600 Ω	20 kΩ	-	+8.2 dBu (2 V)	TRS (3.5 mm) *1	Unbalanced

*1 Tip=LEFT, Ring=RIGHT, Sleeve=GND

* All D/A converters work with 24-bit bit depth and 48-kHz sampling.

Computer interface characteristics

Terminals	Format	Connector	Audio
USB (PC)	USB2.0 High-Speed	USB type C	PCM 24bit, 48 kHz, 10in 4out
USB (CONSOLE)	USB2.0 Full-Speed	USB type C	PCM 16bit, 48 kHz, 2in 2out

* This Guide explains the latest specifications of this product as of the date of publication.

Block diagram

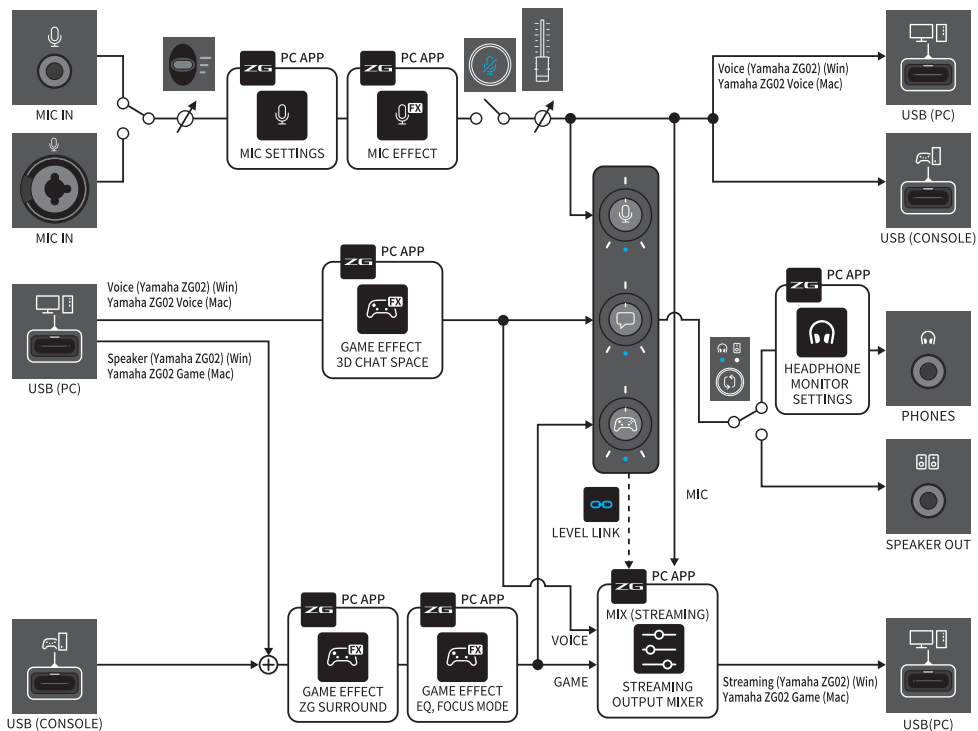

Yamaha Pro Audio global website
<https://www.yamahaproaudio.com/>

Yamaha Downloads
<https://download.yamaha.com/>

© 2023 Yamaha Corporation

Published 09/2023 AM-A0