



DSP-AX3200

AV AMPLIFIER

AMPLIFICATEUR AUDIO-VIDEO

OWNER'S MANUAL
MODE D'EMPLOI
BEDIENUNGSANLEITUNG
BRUKSANVISNING
MANUALE DI ISTRUZIONI
MANUAL DE INSTRUCCIONES
GEBRUIKSAANWIJZING

CAUTION: READ THIS BEFORE OPERATING YOUR UNIT.

- 1 To assure the finest performance, please read this manual carefully. Keep it in a safe place for future reference.
- 2 Install this unit in a well ventilated, cool, dry, clean place with at least 30 cm on the top, 20 cm on the right and left, and 10 cm at the back of this unit — away from direct sunlight, heat sources, vibration, dust, moisture, and/or cold.
- 3 Locate this unit away from other electrical appliances, motors, or transformers to avoid humming sounds. To prevent fire or electrical shock, do not place this unit where it may get exposed to rain, water, and/or any type of liquid.
- 4 Do not expose this unit to sudden temperature changes from cold to hot, and do not locate this unit in a environment with high humidity (i.e. a room with a humidifier) to prevent condensation inside this unit, which may cause an electrical shock, fire, damage to this unit, and/or personal injury.
- 5 On the top of this unit, do not place:
 - Other components, as they may cause damage and/or discoloration on the surface of this unit.
 - Burning objects (i.e. candles), as they may cause fire, damage to this unit, and/or personal injury.
 - Containers with liquid in them, as they may cause electrical shock to the user and/or damage to this unit.
- 6 Do not cover this unit with a newspaper, tablecloth, curtain, etc. in order not to obstruct heat radiation. If the temperature inside this unit rises, it may cause fire, damage to this unit, and/or personal injury.
- 7 Do not plug in this unit to a wall outlet until all connections are complete.
- 8 Do not operate this unit upside-down. It may overheat, possibly causing damage.
- 9 Do not use force on switches, knobs and/or cords.
- 10 When disconnecting the power cord from the wall outlet, grasp the plug; do not pull the cord.
- 11 Do not clean this unit with chemical solvents; this might damage the finish. Use a clean, dry cloth.
- 12 Only voltage specified on this unit must be used. Using this unit with a higher voltage than specified is dangerous and may cause fire, damage to this unit, and/or personal injury. YAMAHA will not be held responsible for any damage resulting from use of this unit with a voltage other than specified.
- 13 To prevent damage by lightning, disconnect the power cord from the wall outlet during an electrical storm.
- 14 Take care of this unit so that no foreign objects and/or liquid drops inside this unit.
- 15 Do not attempt to modify or fix this unit. Contact qualified YAMAHA service personnel when any service is needed. The cabinet should never be opened for any reasons.
- 16 When not planning to use this unit for long periods of time (i.e. vacation), disconnect the AC power plug from the wall outlet.
- 17 Be sure to read the “TROUBLESHOOTING” section on common operating errors before concluding that this unit is faulty.
- 18 Before moving this unit, press STANDBY/ON to set this unit in the standby mode, and disconnect the AC power plug from the wall outlet.

This unit is not disconnected from the AC power source as long as it is connected to the wall outlet, even if this unit itself is turned off. This state is called the standby mode. In this state, this unit is designed to consume a very small quantity of power.

■ For U.K. customers

If the socket outlets in the home are not suitable for the plug supplied with this appliance, it should be cut off and an appropriate 3 pin plug fitted. For details, refer to the instructions described below.

Note

- The plug severed from the mains lead must be destroyed, as a plug with bared flexible cord is hazardous if engaged in a live socket outlet.

■ Special Instructions for U.K. Model

IMPORTANT

THE WIRES IN MAINS LEAD ARE COLOURED IN ACCORDANCE WITH THE FOLLOWING CODE:

Blue: NEUTRAL

Brown: LIVE

As the colours of the wires in the mains lead of this apparatus may not correspond with the coloured markings identifying the terminals in your plug, proceed as follows:

The wire which is coloured BLUE must be connected to the terminal which is marked with the letter N or coloured BLACK. The wire which is coloured BROWN must be connected to the terminal which is marked with the letter L or coloured RED.

Making sure that neither core is connected to the earth terminal of the three pin plug.

CONTENTS

INTRODUCTION

CONTENTS	1
FEATURES	2
GETTING STARTED	3
Checking the Package Contents	3
Installing Batteries in the Remote Control	3
CONTROLS AND FUNCTIONS	4
Front Panel	4
Remote Control	6
Using the Remote Control	7
Front Panel Display	8
Rear Panel	9

PREPARATION

SPEAKER SETUP	10
Speakers to Be Used	10
Speaker Placement	10
Connecting the Speakers	11
CONNECTIONS	14
Before Connecting Components	14
Connecting Video Components	14
Connecting Audio Components	16
Connecting to an External Amplifier	18
Connecting an External Decoder	18
Connecting the Power Supply Cords	19
Turning on the Power	19
ON-SCREEN DISPLAY (OSD)	20
OSD Modes	20
Selecting the OSD Mode	20
SPEAKER MODE SETTINGS	21
Summary of SPEAKER SET Items 1A through 1F ...	21
ADJUSTING THE SPEAKER OUTPUT LEVELS	22
Before You Begin	22
Using the Test Tone (TEST DOLBY SUR.)	22

BASIC OPERATION

BASIC PLAYBACK	24
Input Modes and Indications	26
Selecting a Sound Field Program	27
Selecting PRO LOGIC or Neo: 6	28
DIGITAL SOUND FIELD PROCESSING (DSP)	30
Understanding Sound Fields	30
Hi-Fi DSP Programs	30
CINEMA-DSP	32
Sound Design of CINEMA-DSP	32
CINEMA-DSP Programs	34
BASIC RECORDING	36

ADVANCED OPERATION

REMOTE CONTROL FEATURES	37
Control Area	37
Setting the Manufacturer Code	38
Programming a New Remote Control Function (Learn Feature)	39
Using the Macro Feature	40
Changing the Source Name in the Display Window	42
Clearing Learned Functions, Macros, Renamed Source Names, and Setup Manufacturer Codes ...	42
Clearing a Learned Function or Macro	43
Each Component Control Area	45
SET MENU	50
Adjusting the Items on the SET MENU	50
1 SPEAKER SET (speaker mode settings)	51
2 LOW FRQ TEST	54
3 L/R BALANCE (balance of the left and right main speakers)	55
4 HP TONE CTRL (headphone tone control)	55
5 CENTER GEQ (center graphic equalizer)	55
6 INPUT RENAME	56
7 I/O ASSIGNMENT	56
8 INPUT MODE (initial input mode)	57
9 PARAM. INI (parameter initialization)	58
10 LFE LEVEL	58
11 D-RANGE	59
12 SP DELAY TIME	59
13 DISPLAY SET	60
14 MEMORY GUARD	60
ADJUSTING THE LEVEL OF THE EFFECT SPEAKERS	61
SLEEP TIMER	62
Setting the Sleep Timer	62
Canceling the Sleep Timer	62

ADDITIONAL INFORMATION

SOUND FIELD PROGRAM PARAMETER EDITING	63
What is a sound field?	63
Sound Field Program Parameters	63
Changing Parameter Settings	64
Resetting a Parameter to the Factory-set Value	64
DIGITAL SOUND FIELD PARAMETER DESCRIPTIONS	65
TROUBLESHOOTING	69
GLOSSARY	73
SPECIFICATIONS	75

INTRODUCTION

PREPARATION

BASIC OPERATION

ADVANCED OPERATION

ADDITIONAL INFORMATION

English

FEATURES

Built-in 6-Channel Power Amplifier

- ◆ Minimum RMS Output Power (0.02% THD, 20 Hz – 20 kHz, 8Ω)
 - Main: 120 W + 120 W
 - Center: 120 W
 - Rear: 120 W + 120 W
 - Rear center: 120 W

Multi-Mode Digital Sound Field Processing

- ◆ Dolby Pro Logic/Dolby Pro Logic II Decoder
- ◆ Dolby Digital/Dolby Digital Matrix 6.1 Decoder
- ◆ DTS/DTS ES (Matrix 6.1, Discrete 6.1)/DTS Neo: 6 Decoder
- ◆ CINEMA DSP: Combination of YAMAHA DSP Technology and Dolby Pro Logic, Dolby Digital or DTS
- ◆ Virtual CINEMA DSP
- ◆ SILENT CINEMA DSP

Other Features

- ◆ 96-kHz/24-bit D/A Converter
- ◆ “SET MENU” which Provides You with 14 Items for Optimizing This Unit for Your Audio/Video System
- ◆ Test Tone Generator for Easier Speaker Balance Adjustment
- ◆ 6-Channel External Decoder Input for Other Future Formats
- ◆ BASS EXTENSION for Reinforcing Bass Response
- ◆ On Screen Display Function Helpful in Controlling This Unit
- ◆ S Video Signal Input/Output Capability
- ◆ Component Video Input/Output Capability
- ◆ Optical and Coaxial Digital Audio Signal Jacks
- ◆ Sleep Timer
- ◆ Remote Control with Preset Manufacturer Codes and “Learning” Capability
- ◆ PROCESSOR DIRECT for no alteration of the original signal

• ☀ indicates a tip for your operation.

• Some operations can be performed by using either the buttons on the main unit or on the remote control. In cases when the button names differ between the main unit and the remote control, the button name on the remote control is given in parentheses in this manual.



Manufactured under license from Dolby Laboratories.

“Dolby”, “Pro Logic”, and the double-D symbol are trademarks of Dolby Laboratories.



“DTS”, “DTS-ES Extended Surround” and “Neo: 6” are trademarks of Digital Theater System, Inc.

GETTING STARTED

Checking the Package Contents

Check your package to make sure it has the following items.

Remote control

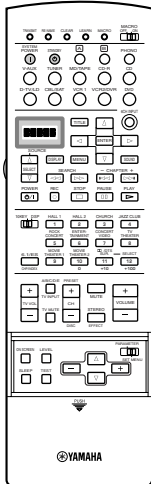

Batteries (3) (LR6)

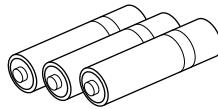

Connection Guide

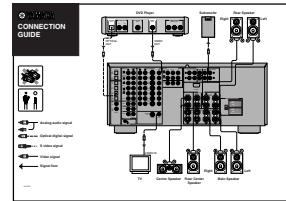

Power Cord
(Europe model only)

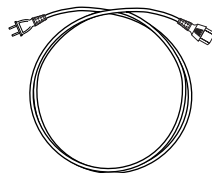

Installing Batteries in the Remote Control

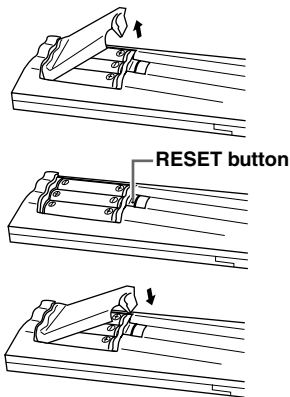

- 1** Open the battery compartment cover.
- 2** Insert three supplied batteries (LR6) in the correct direction by aligning the + and – marks on the batteries with the polarity markings (+ and –) on the inside of the battery compartment.
- 3** After new batteries are correctly inserted, press the RESET button in the battery compartment using a ball point pen or similar object. (This does not clear the contents of the memory.)
- 4** Replace the cover as pressing until it snaps into place.

Notes on batteries

- Change all of the batteries if you notice the condition like; the operating range of the remote control decreases, the indicator does not flash or its light becomes dim.
- Do not use old batteries together with new ones.
- Do not use different types of batteries (such as alkaline and manganese batteries) together. Read the packaging carefully as these different types of batteries may have the same shape and color.
- If the batteries have leaked, dispose of them immediately. Avoid touching the leaked material or letting it come into contact with clothing, etc. Clean the battery compartment thoroughly before installing new batteries.

If the remote control is without batteries for more than 3 minutes, or if exhausted batteries remain in the remote control, the contents of the memory may be cleared. When the memory is cleared, insert new batteries, set up the manufacturer code and program any acquired functions that may have been cleared.

CONTROLS AND FUNCTIONS

Front Panel

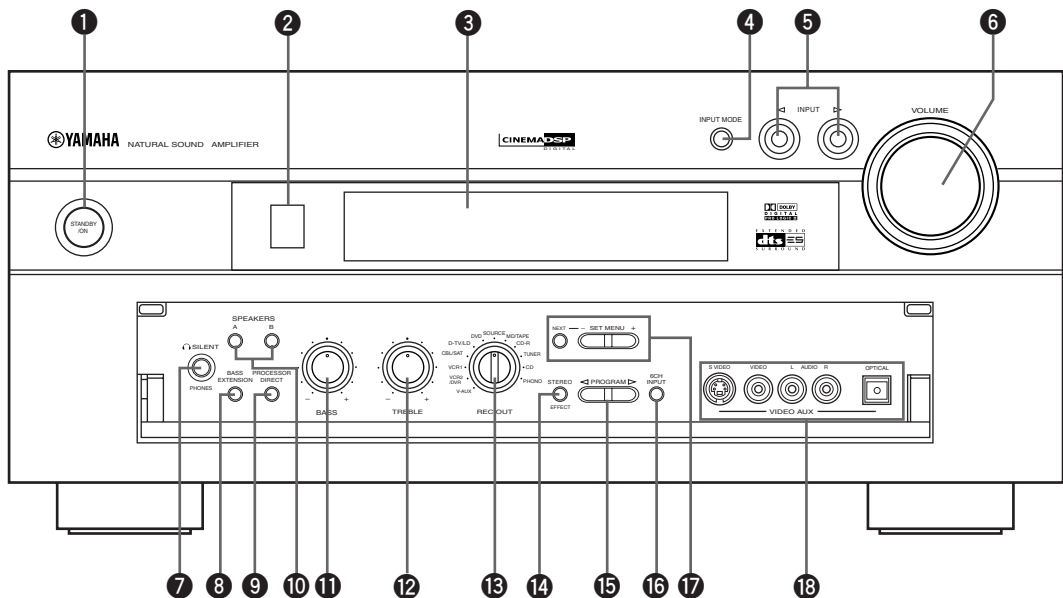

1 STANDBY/ON

Turns on and sets this unit in the standby mode. When you turn on this unit, you will hear a click and there will be a 4 to 5-second delay before this unit can reproduce sound.

Standby mode

In this mode, this unit consumes a small amount of power to receive infrared-signals from the remote control.

2 Remote control sensor

Receives signals from the remote control.

3 Front panel display

Shows information about the operational status of this unit (see page 8).

4 INPUT MODE

Sets the priority for the types of input signals (AUTO, DTS, ANALOG) to receive when one component is connected to two or more input jacks of this unit (see page 26). Priority cannot be set when 6CH INPUT is selected as the input source.

5 INPUT ◀/▶

Selects the input source you want to listen to or watch.

6 VOLUME

Controls the output level of all audio channels. This does not affect the REC OUT level.

7 PHONES jack

Outputs audio signals for private listening with headphones. When you connect headphones, no signals are output to the PRE OUT jacks or to the speakers.

8 BASS EXTENSION

Turns on or off the BASS EXTENSION function at each time the button is pressed, this feature boosts the bass frequency of the left and right main channels by +6 dB (60 Hz) while maintaining overall tonal balance. This boost is useful if you do not use a subwoofer. However, this boost may not be noticeable if "1B MAIN SP" on the SET MENU is set to SMALL and "1E LFE/BASS OUT" is set to SWFR.

9 PROCESSOR DIRECT

Turns on or off the PROCESSOR DIRECT function at each time the button is pressed. When this is on, BASS, TREBLE, and BASS EXTENSION are bypassed, eliminating any alteration of the original signal.

10 SPEAKERS A/B

Turn on or off the set of main speakers connected to the A and/or B terminals on the rear panel at each time its corresponding button is pressed.

11 BASS

Adjusts the low-frequency response for the left and right main channels.

Turn the control to the right to increase or to the left to decrease the low-frequency response.

12 TREBLE

Adjusts the high-frequency response for the left and right main channels.

Turn the control to the right to increase or to the left to decrease the high-frequency response.

Note

- If you increase or decrease the high-frequency or the low-frequency sound to an extreme level, the tonal quality from the center and rear speakers may not match that of the left and right main speakers.

13 REC OUT

Selects the source you want to direct to the audio/video recorder.

14 STEREO/EFFECT

Switches the normal stereo or DSP effect reproduction. When STEREO is selected, 2-channel input signals are directed to the main left and right speakers without effect sounds. All Dolby Digital and DTS audio signals except for the LFE channel are mixed down to the main left and right speakers.

15 PROGRAM ◀ / ▶

Selects the DSP program.

16 6CH INPUT

Selects the source connected to the 6CH INPUT jacks. The source selected by pressing 6CH INPUT takes priority over the source selected with INPUT ◀ / ▶ (or the input selector buttons on the remote control).

17 NEXT — SET MENU -/+

Changes the SET MENU settings.

18 VIDEO AUX jacks

Input audio and video signals from a portable external source such as a game console. To reproduce source signals from these jacks, select V-AUX as the input source.

Opening and closing the front panel door

When you are not operating the controls behind the front panel door, close the door.

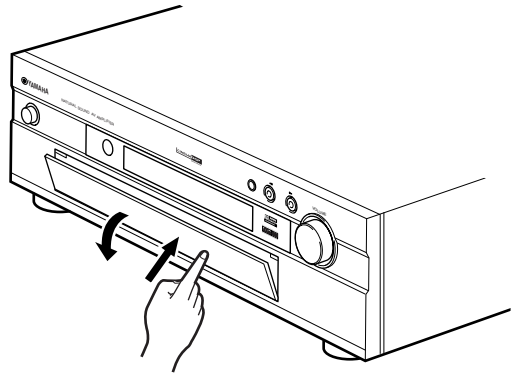

To open, press gently on the lower part of the panel.

Remote Control

This section describes the controls and their functions of the remote control. See “REMOTE CONTROL FEATURES” on pages 37 to 49 for operating other components with this remote control.

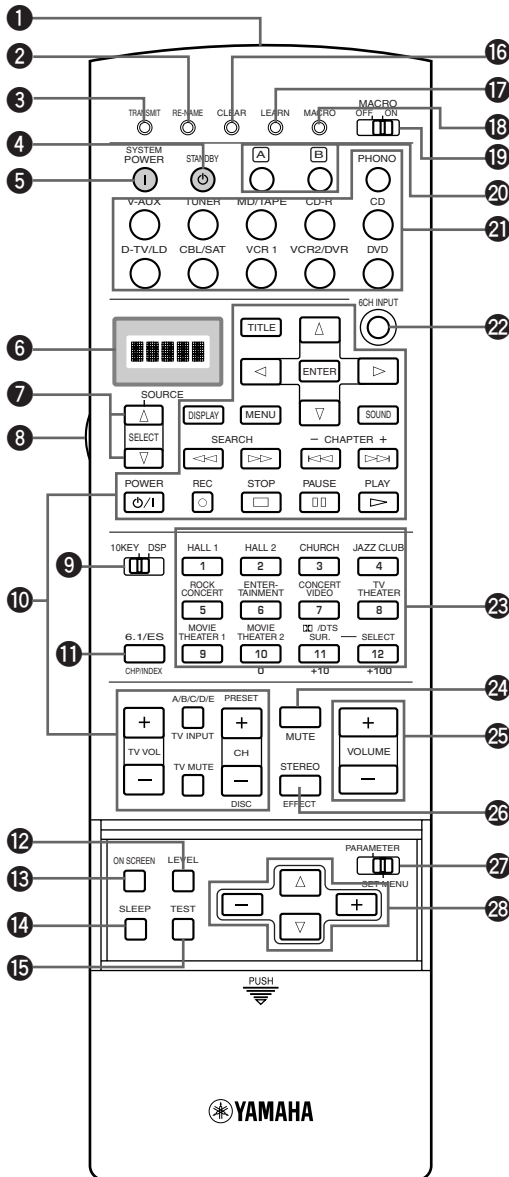

1 Infrared window

Outputs infrared control signals. Aim this window at the component you want to operate.

2 RE-NAME

Used for changing the input source name in the display window (see page 42).

3 TRANSMIT indicator

Flashes while the remote control is sending signals.

4 STANDBY

Sets this unit in the standby mode.

5 SYSTEM POWER

Turns on the power of this unit.

6 Display window

Shows the selected source component that you are controlling.

7 SOURCE SELECT Δ/∇

Selects the another component to control independently from the input that has been selected by pressing an input selector button.

8 LIGHT

Turns the light on or off. When you press this button once, the light turns on for about ten seconds. Press again to turn off the light.

9 10KEY/DSP

Selects the numeric button (10KEY) mode or DSP mode.

10 Operation buttons

Provides functions such as play, stop, skip, etc. for operating your other components selected by the input selector buttons.

11 6.1/ES

Turns on or off the Dolby Digital Matrix 6.1 or DTS ES decoder with 10KEY/DSP set to the DSP position.

12 LEVEL

Selects the effect speaker channel to be adjusted and sets the level.

13 ON SCREEN

Selects the on-screen display (OSD) mode for your video monitor.

14 SLEEP

Sets the sleep timer.

15 TEST

Outputs the test tone to adjust the speaker levels.

16 CLEAR

Used for clearing functions acquired when using the learn and rename features, programmed macros, and set manufacturer codes (see pages 42 to 44).

17 LEARN

Used for setting up the manufacturer code or for programming the functions of other remote controls (see pages 38 and 39).

18 MACRO

Used to program a series of operations for control by a single button (see pages 40 to 42).

19 MACRO ON/OFF

Turns the macro function on and off.

20 A and B

Switch the control area for the extra components that are not connected to this unit without changing the input.

21 Input selector buttons

Select the input source and change the control area.

22 6CH INPUT

Selects the source connected to the 6CH INPUT jacks.

23 DSP program/Numeric buttons

Select DSP programs or numbers according to the position of 10KEY/DSP.

24 MUTE

Mutes the sound. The MUTE indicator turns on when the MUTE function is on. Press again to restore the audio output to the previous volume level.

25 VOLUME +/-

Increases or decreases the volume level.

26 STEREO/EFFECT

Switches the normal stereo or DSP effect reproduction. When STEREO is selected, 2-channel input signals are directed to the main left and right speakers without effect sounds. All Dolby Digital and DTS audio signals except for the LFE channel are also directed to the main left and right speakers.

27 PARAMETER/SET MENU

Selects the PARAMETER mode or SET MENU mode.

28 Cursor buttons $\Delta/\nabla/-/+$

Select and adjust DSP program parameters and SET MENU items according to the position of PARAMETER/SET MENU.

Using the Remote Control

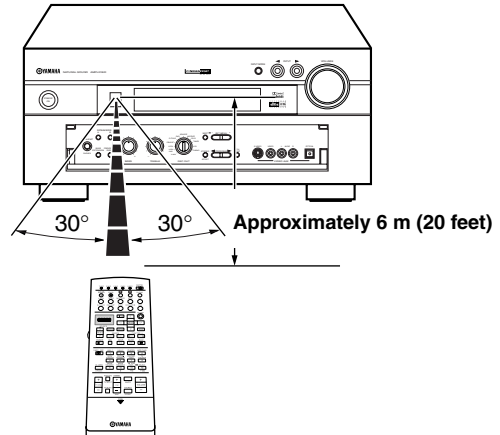

The remote control transmits a directional infrared beam. Be sure to aim the remote control directly at the remote control sensor on the main unit during operation.

■ Handling the remote control

- Do not spill water or other liquids on the remote control.
- Do not drop the remote control.
- Do not leave or store the remote control in the following types of conditions:
 - high humidity or temperature such as near a heater, stove or bath;
 - dusty places; or
 - in places subject to extremely low temperatures.

Front Panel Display

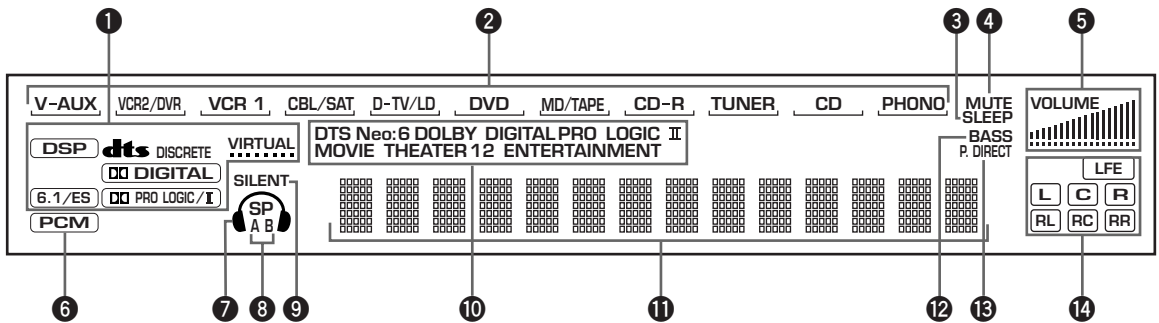

1 Processor indicators

When any function of (DSP), DTS, DISCRETE, VIRTUAL, (DIGITAL), (6.1/ES), and (PRO LOGIC II) is activated, its indicator lights up.

2 Input source indicator

Shows the current input source with a cursor.

3 SLEEP indicator

Lights up while the sleep timer is on.

4 MUTE indicator

Flashes up while the MUTE function is on.

5 VOLUME level indicator

Indicates the volume level.

6 (PCM) indicator

Lights up when this unit is reproducing PCM (pulse code modulation) digital audio signals.

7 Headphones indicator

Lights up when headphones are connected.

8 SP A B indicators

Lights up according to which set of main speakers is selected. Both indicators light up when both sets of speakers are selected.

9 SILENT indicator

Lights up when headphones are connected with the sound effect (see "SILENT CINEMA DSP" on page 29).

10 DSP program indicators

The name of the selected DSP program lights up when the ENTERTAINMENT, MOVIE THEATER 1, MOVIE THEATER 2 or (DTS)/DTS SURROUND DSP program is selected.

11 Multi-information display

Shows the current DSP program name and other information when adjusting or changing settings.

12 BASS indicator

Lights up while BASS EXTENSION is on.

13 P. DIRECT

Lights up while PROCESSOR DIRECT is on.

14 Input channel indicator

Indicates the channel components of input signals being received.

Rear Panel

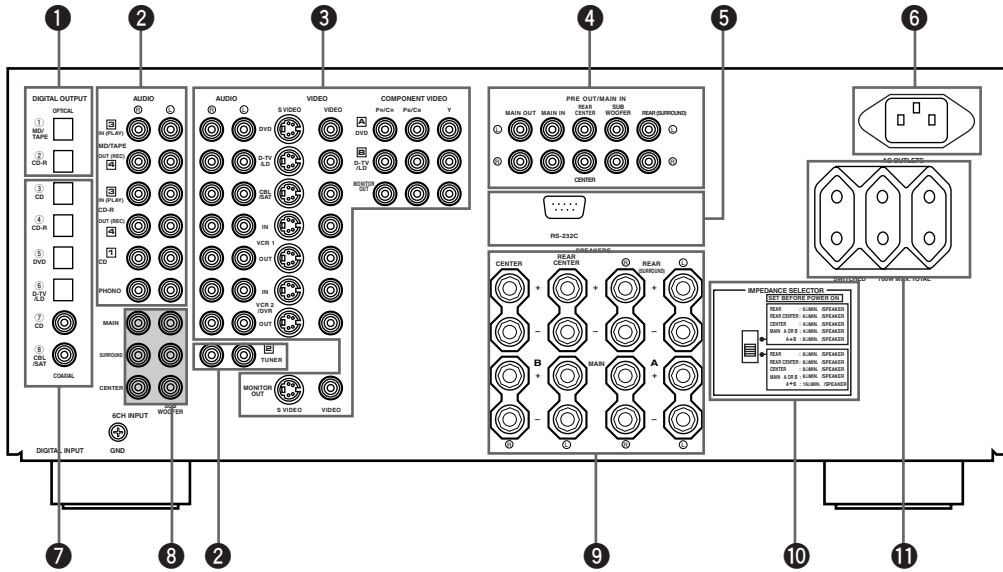

(Europe model)

1 DIGITAL OUTPUT jacks

2 Audio component jacks

See pages 16 and 17 for connection information.

3 Video component jacks

See pages 14 and 15 for connection information.

4 PRE OUT/MAIN IN jacks

See page 18 for connection information.

5 RS232C terminal

This is a control expansion terminal for commercial use. Consult your dealer for details.

6 AC INLET (Europe model only)

Use this inlet to plug in the supplied power cord.

7 DIGITAL INPUT jacks

8 6CH INPUT jacks

See page 18 for connection information.

9 Speaker terminals

See pages 11 and 12 for connection information.

10 IMPEDANCE SELECTOR switch

Use this switch to match the amplifier output to your speaker impedance (see page 13). Set this unit in the standby mode before you change the setting of this switch.

11 AC OUTLETS

Use these outlets to supply power to your other A/V components (see page 19).

SPEAKER SETUP

Speakers to Be Used

This unit has been designed to provide the best sound-field quality with a 6-speaker system, using left and right main speakers, left and right rear speakers, and a center and rear center speakers. If you use different brands of speakers (with different tonal qualities) in your system, the tone of a moving human voice and other types of sound may not shift smoothly. We recommend that you use speakers from the same manufacturer or speakers with the same tonal quality.

The main speakers are used for the main source sound plus the effect sounds. They will probably be the speakers from your present stereo system. The rear speakers are used for the effect and surround sounds, and the center speaker is for the center sounds (dialog, vocals, etc.).

The main speakers should be high-performance models and have enough power-handling capacity to accept the maximum output of your audio system. The other speakers do not have to be equal to the main speakers. For precise sound localization, however, it is ideal to use the models of equivalent performance with the main speakers.

■ Use of a subwoofer expands your sound field

It is also possible to further expand your system with the addition of a subwoofer. The use of a subwoofer is effective not only for reinforcing bass frequencies from any or all channels, but also for reproducing the LFE (low-frequency effect) channel with high fidelity when the Dolby Digital signal or the DTS signal is played back. The YAMAHA Active Servo Processing Subwoofer System is ideal for natural and lively bass reproduction.

Speaker Placement

Refer to the following diagram when you place the speakers.

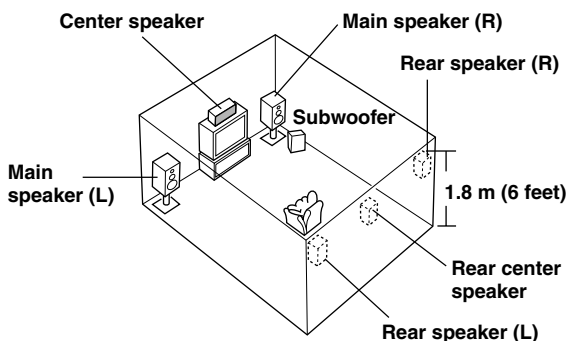

■ Main speakers

Place the left and right main speakers an equal distance from the ideal listening position. The distance of each speaker from each side of the video monitor should be the same.

■ Center speaker

Align the front face of the center speaker with the front face of your video monitor. Place the speaker as close to the monitor as possible, such as directly over or under the monitor and centrally between the main speakers.

Note

- If the center speaker is not used, the center channel sound will be heard from the left and right main speakers. In this case, "1A CENTER SP" on the SET MENU is set to NONE (see page 51 for details).

■ Rear speakers

Place these speakers behind your listening position, facing slightly inwards, nearly 1.8 m (6 feet) above the floor.

■ Rear center speaker

Place the rear center speaker in the center between the left and right rear speakers at the same height from the floor as the rear speakers.

■ Subwoofer

The position of the subwoofer is not so critical, because low bass sounds are not highly directional. But it is better to place the subwoofer near the main speakers. Turn it slightly toward the center of the room to reduce the wall reflections.

CAUTION

Use magnetically shielded speakers. If this type of speakers still creates the interference with a monitor, place the speakers away from the monitor.

Connecting the Speakers

Be sure to connect the left channel (L), right channel (R), “+” (red) and “-” (black) properly. If the connections are faulty, no sound will be heard from the speakers, and if the polarity of the speaker connections is incorrect, the sound will be unnatural and lack bass.

CAUTION

- Use speakers with the specified impedance shown on the rear panel of this unit.
- Do not let the bare speaker wires touch each other and do not let them touch any metal part of this unit. This could damage this unit and/or speakers.

If necessary, use the SET MENU to change the speaker mode settings according to the number and size of the speakers in your configuration after you finish connecting your speakers.

■ Speaker cables

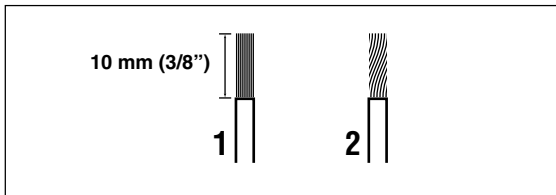

A speaker cord is actually a pair of insulated cables running side by side. One of the cables is colored or shaped differently, perhaps with a stripe, groove or ridge.

- 1** Remove approximately 10 mm (3/8”) of insulation from each of the speaker cables.
- 2** Twist the exposed wires of the cable together to prevent short circuits.

■ Connecting to the SPEAKERS terminals

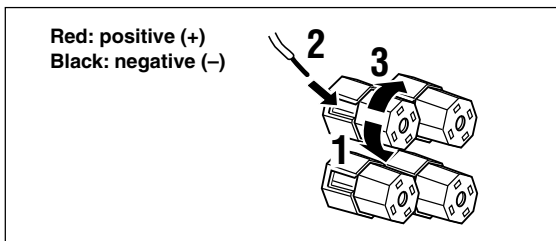

- 1** Unscrew the knob.
- 2** Insert one bare wire into the hole in the side of each terminal.
- 3** Tighten the knob to secure the wire.

■ MAIN SPEAKERS terminals

One or two speaker systems can be connected to these terminals. If you use only one speaker system, connect it to either of the MAIN A or B terminals.

■ REAR SPEAKERS terminals

A rear speaker system can be connected to these terminals.

■ CENTER SPEAKER terminals

A center speaker can be connected to these terminals.

■ REAR CENTER SPEAKER terminals

A rear center speaker can be connected to these terminals.

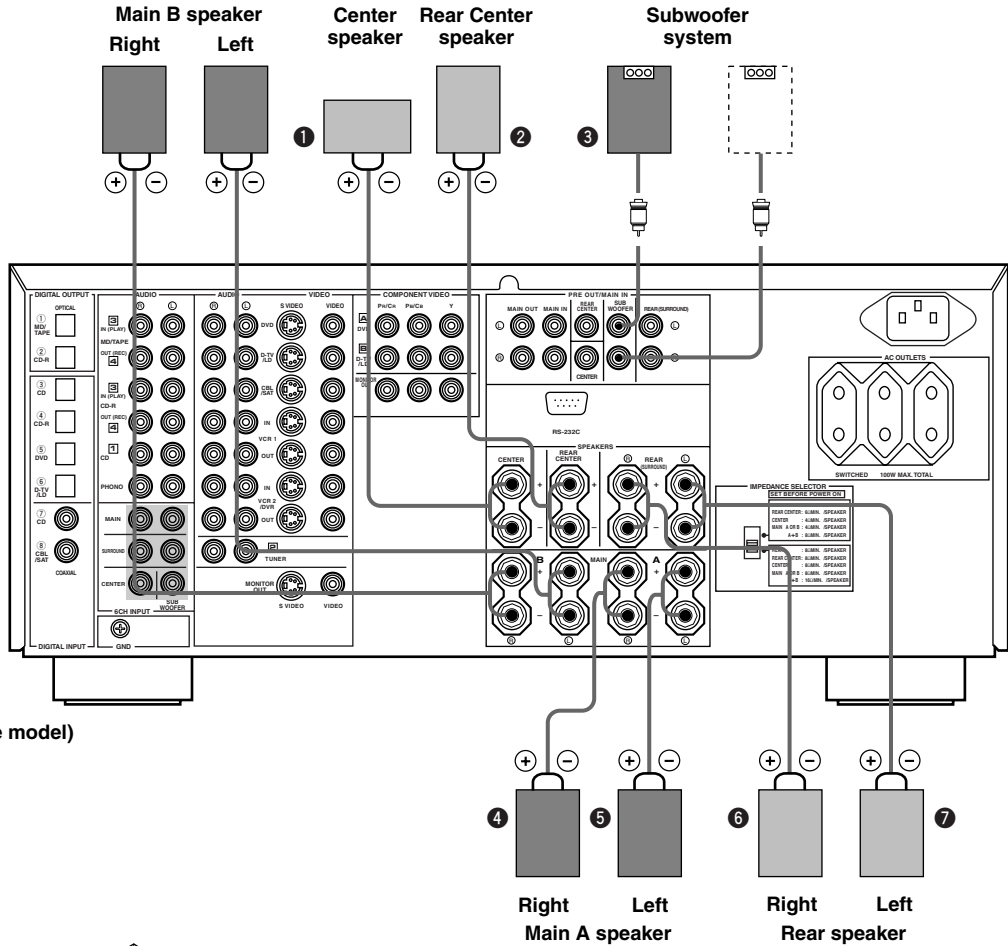

(Europe model)

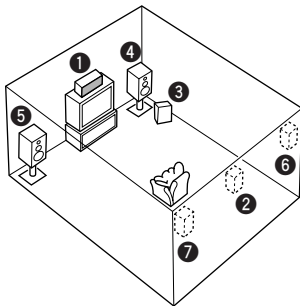

The diagram above shows the speaker layout in the listening room.

■ SUBWOOFER jack

When using a subwoofer with built-in amplifier, including the YAMAHA Active Servo Processing Subwoofer System, connect the input jack of the subwoofer system to this jack. Low bass signals distributed from the main, center and/or rear channels are directed to this jack if they are assigned to this jack. (The cut-off frequency of this jack is 90 Hz.) The LFE (low-frequency effect) signals generated when Dolby Digital or DTS is decoded are also directed if they are assigned to this jack.

Notes

- Adjust the volume level of the subwoofer with the control on the subwoofer. It is also possible to adjust the volume level by using the remote control of this unit (see ADJUSTING THE LEVEL OF THE EFFECT SPEAKERS on page 61).
- Depending on the settings of “1 SPEAKER SET” and “10 LFE LEVEL” on the SET MENU, some signals may not be output from the SUBWOOFER jack.

■ IMPEDANCE SELECTOR switch

WARNING

Do not change the IMPEDANCE SELECTOR switch setting while the power of this unit is on, otherwise this unit may be damaged.

If this unit fails to turn on when STANDBY/ON (or SYSTEM POWER) is pressed, the IMPEDANCE SELECTOR switch may not be fully slid to either position. If so, slide the switch to either position fully when this unit is in the standby mode.

Select the left and right position according to the impedance of the speakers in your system. Be sure to move this switch only when this unit is in the standby mode.

IMPEDANCE SELECTOR switch

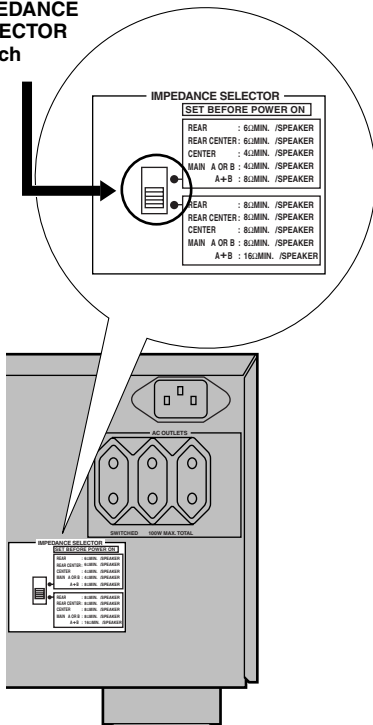

Switch position	Speaker	Impedance level
Upper	Main	If you use one set of main speakers, the impedance of each speaker must be 4 Ω or higher. If you use two sets of main speakers, the impedance of each speaker must be 8 Ω or higher.
	Center	The impedance must be 4 Ω or higher.
	Rear Center	The impedance must be 6 Ω or higher.
	Rear	The impedance of each speaker must be 6 Ω or higher.
Lower	Main	If you use one set of main speakers, the impedance of each speaker must be 8 Ω or higher. If you use two sets of main speakers, the impedance of each speaker must be 16 Ω or higher.
	Center	The impedance must be 8 Ω or higher.
	Rear Center	The impedance must be 8 Ω or higher.
	Rear	The impedance of each speaker must be 8 Ω or higher.

(Europe model)

CONNECTIONS

Before Connecting Components

CAUTION

Never connect this unit and other components to mains power until all connections between components have been completed.

- Be sure all connections are made correctly, that is to say L (left) to L, R (right) to R, “+” to “+” and “-” to “-”. Some components require different connection methods and have different jack names. Refer to the operation instructions for each component to be connected to this unit.
- When you connect other YAMAHA audio components (such as a tape deck, MD recorder and CD player or changer), connect them to the jack with the same number labels as **1**, **3**, **4** etc. YAMAHA applies this labeling system to all its products.
- After you have completed all connections, check them again to make sure they are correct.

Connecting Video Components

■ About the video jacks

There are three types of video jacks. Video signals input through the VIDEO jacks are the conventional composite video signals. Video signals input through the S VIDEO jacks are separated into luminance (Y) and color (C) video signals. The S-video signals achieve high-quality color reproduction. Video signals input through the COMPONENT VIDEO jacks are separated into luminance (Y) and color difference (P_B/C_B, P_R/C_R) video signals. The jacks are also separated into three for each signal. The description of the component video jacks may be different depending on the component (e.g. Y, C_B, C_R/Y, P_B, P_R/Y, B-Y, R-Y etc.). Component video signals provide the best quality in picture reproduction.

If your video component has an S-video output or component video output, you can connect it to this unit. Connect the S-video signal output jack on your video component to the S VIDEO jack or connect the component signal output jacks on your video component to the COMPONENT VIDEO jacks.

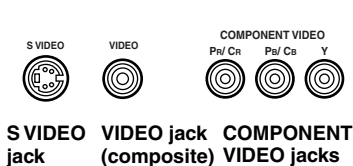

- Each type of video jack works independently. Signals input through the composite video, S-video and component jacks are output through the corresponding composite video, S-video, and component jacks, respectively.
- You can designate the input for the COMPONENT VIDEO A and B jacks according to your component by using “7 I/O ASSIGNMENT” on the SET MENU (see pages 56 and 57 for details).

Notes

- Use a commercially available S-video cable when connecting to the S VIDEO jack, and commercially available video cables when connecting to the COMPONENT VIDEO jacks.
- When you are using the COMPONENT VIDEO jacks, check the details in the owner’s manual that came with the component being connected.

■ VIDEO AUX jacks (on the front panel)

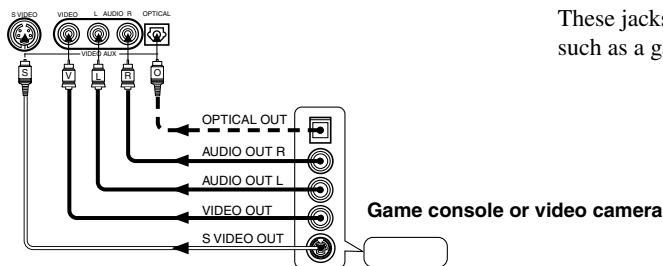

These jacks are used to connect any video input source such as a game console and a video camera to this unit.

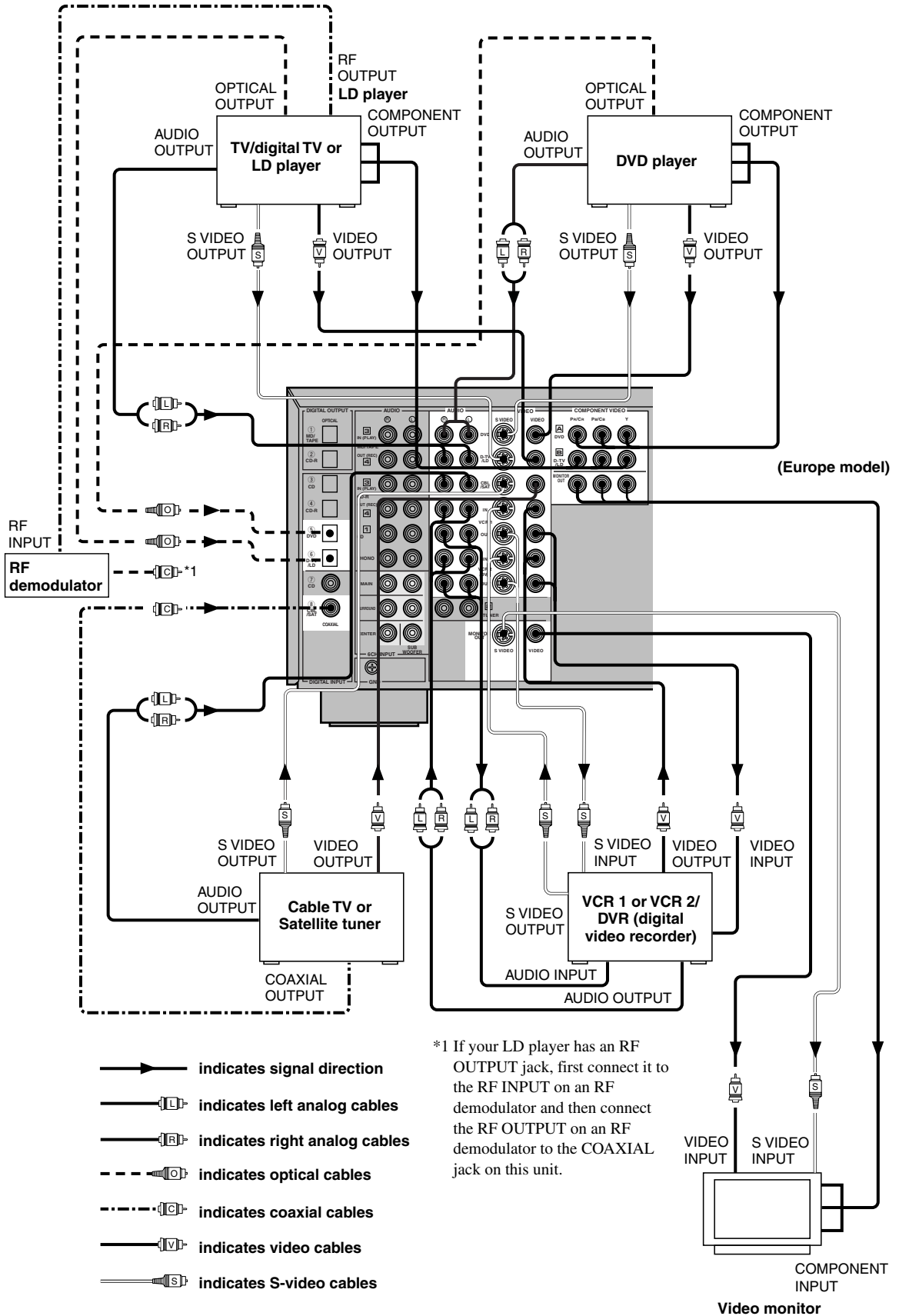

Connecting Audio Components

■ Connecting to digital jacks

This unit has digital jacks for direct transmission of digital signals through either coaxial or fiber optic cables. You can use the digital jacks to input PCM, Dolby Digital and DTS bitstreams. When you connect components to both the COAXIAL and OPTICAL jacks, priority is given to the input signals from the COAXIAL jack. All digital input jacks are acceptable for 96-kHz sampling digital signals.



- You can designate the input for each digital jacks according to your component by using “7 I/O ASSIGNMENT” on the SET MENU (see pages 56 and 57 for details).

Note

- The OPTICAL jacks on this unit conform to the EIA standard. If you use a fiber optic cable that does not conform to this standard, this unit may not function properly.

■ Connecting a turntable

PHONO jacks are for connecting a turntable with an MM or high-output MC cartridge. If you have a turntable with a low-output MC cartridge, use an in-line boosting transformer or MC-head amplifier when connecting to these jacks.



- Connect your turntable to the GND terminal to reduce noise in the signal. However you may hear less noise without the connection to the GND terminal for some record players.

■ Connecting a CD player



- The COAXIAL CD and OPTICAL CD jacks are available for a CD player which has coaxial or optical digital output jacks.
- When you connect a CD player to both the COAXIAL CD and OPTICAL CD jacks, priority is given to the input signals from the COAXIAL CD jack.

■ Connecting an MD recorder, tape deck or CD recorder



- DIGITAL OUTPUT jacks and analog OUT (REC) are independent. Only digital signals are output from DIGITAL OUTPUT jacks and analog signals from OUT (REC) jacks.
- When you connect your recording component to both the analog and digital input and output jacks, the priority is given to the digital signal.

Notes

- When you connect a recording component to this unit, keep its power on while using this unit. If the power is off, this unit may distort the sound from other components.
- When you record from a source component connected to this unit while this unit is set in the standby mode, the recorded sound may be distorted. To avoid this problem, turn on this unit.

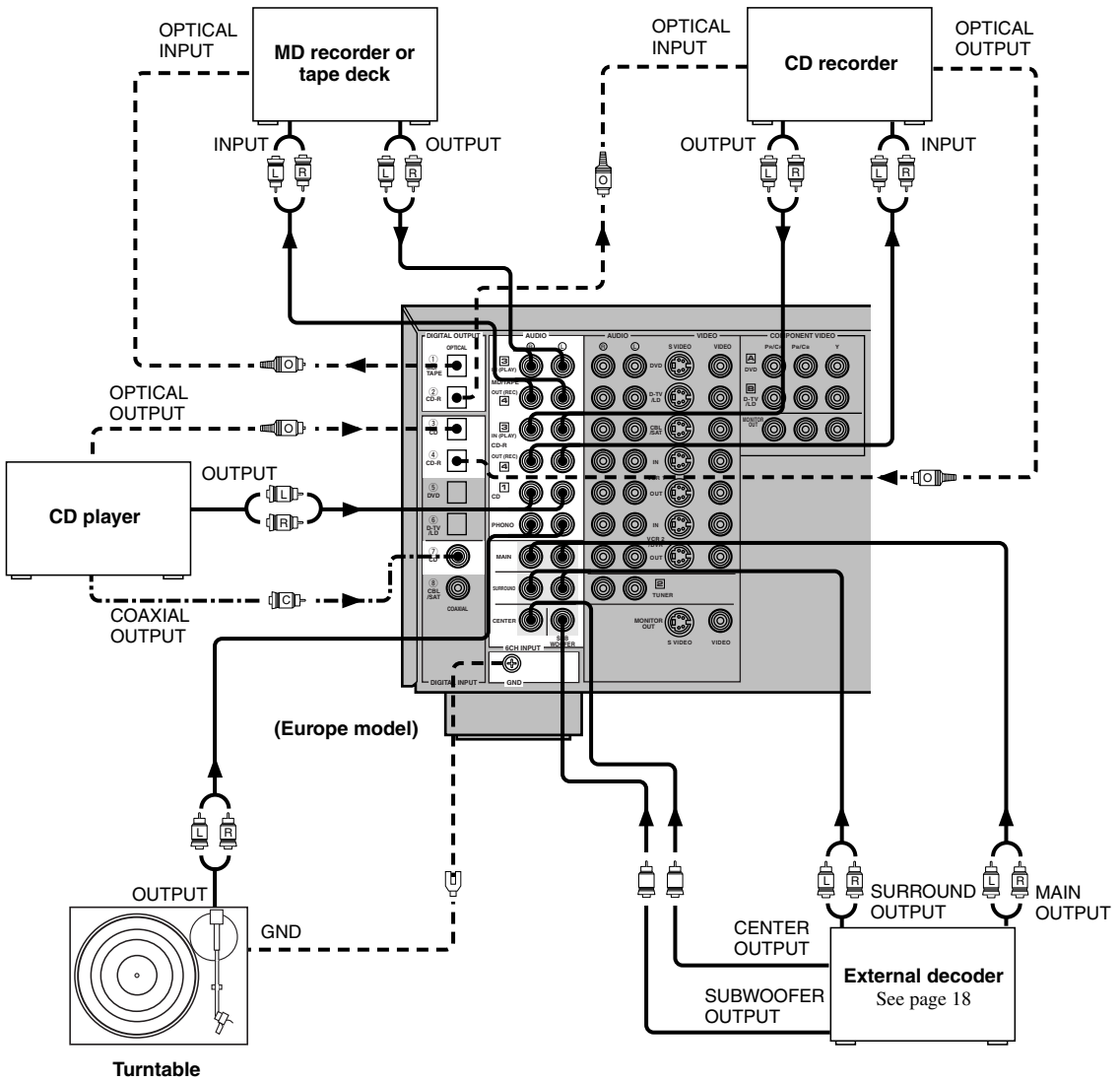

- ▶— indicates signal direction
- (L)— indicates left analog cables
- (R)— indicates right analog cables
- - - (O) indicates optical cables
- - - (C) indicates coaxial cables

Connecting to an External Amplifier

If you want to increase the power output to the speakers, or want to use another amplifier, connect an external amplifier to the PRE OUT/MAIN IN jacks as follows.

Note

- When RCA pin plugs are connected to the PRE OUT/MAIN IN jacks for output to an external amplifier, it is not necessary to use the corresponding SPEAKERS terminals.

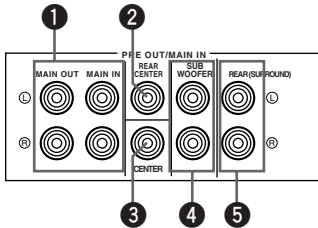

1 MAIN OUT/IN jacks

MAIN OUT jacks Main channel line output jacks.

The signals output through these jacks are affected by VOLUME, BASS, TREBLE, and BASS EXTENSION settings.

MAIN IN jacks Line input to this unit's Main channel amplifiers.

When connecting to these jacks, signals input to the preamplifier of this unit will not be output from the main amplifier of this unit.

2 REAR CENTER jack

Rear center channel line output jack.

3 CENTER jack

Center channel line output jack.

4 SUBWOOFER jack

When using a subwoofer with built-in amplifier, including the YAMAHA Active Servo Processing Subwoofer System, connect the input jack of the subwoofer system to this jack. Low bass signals distributed from the main, center and/or rear channels are directed to this jack if they are assigned to this jack. (The cut-off frequency of this jack is 90 Hz.) The LFE (low-frequency effect) signals generated when Dolby Digital or DTS is decoded are also directed if they are assigned to this jack.

Notes

- Adjust the volume level of the subwoofer with the control on the subwoofer. It is also possible to adjust the volume level by using the remote control of this unit (see ADJUSTING THE LEVEL OF THE EFFECT SPEAKERS on page 61).
- Depending on the settings of "1 SPEAKER SET" and "10 LFE LEVEL" on the SET MENU, some signals may not be output from the SUBWOOFER jack.

5 REAR (SURROUND) jacks

Rear channel line output jacks.

Connecting an External Decoder

This unit is equipped with 6 additional input jacks (left and right MAIN, CENTER, left and right SURROUND and SUBWOOFER) for discrete multi-channel input from an external decoder, sound processor or pre-amplifier.

Connect the output jacks on your external decoder to the 6CH INPUT jacks. Be sure to match the left and right outputs to the left and right input jacks for the main and surround channels.

Notes

- When you select 6CH INPUT as the input source, this unit automatically turns off the digital sound field processor, and you cannot listen to DSP programs.
- When you select 6CH INPUT as the input source, settings of "1 SPEAKER SET" on the SET MENU do not apply (except for 1F MAIN LEVEL).

Connecting the Power Supply Cords

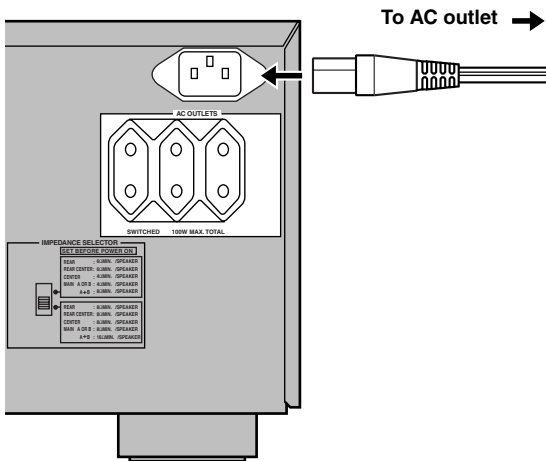

(Europe model)

■ Connecting the AC power cord

[Europe model]

Plug the power cord into the AC inlet when all connections are complete, and then plug in this unit to the wall outlet.

Caution

- Do not use other AC power cords than the one provided. Otherwise it may result in causing fire or an electrical shock.

[U.K. model]

Plug in this unit to the wall outlet.

■ AC OUTLETS (SWITCHED)

Europe model 3 OUTLETS
 U.K. model 1 OUTLET

Use these outlets to connect the power cords from your components to this unit. The power to the AC OUTLETS is controlled by this unit's STANDBY/ON (or SYSTEM POWER and STANDBY). These outlets will supply power to any connected component whenever this unit is turned on. The maximum power (total power consumption of components) that can be connected to the AC OUTLETS is 100 W.

Turning on the Power

When all connections are completed, turn on the power of this unit.

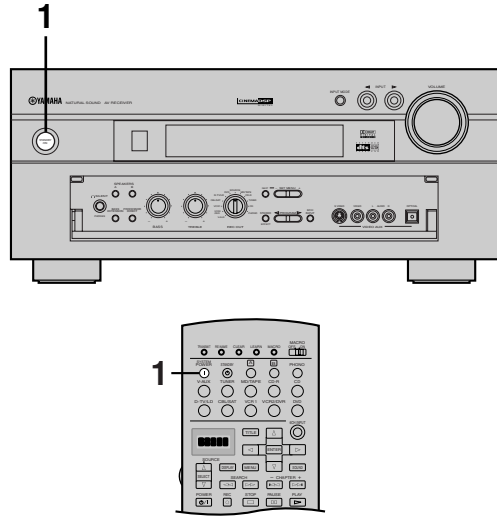

- 1 Press STANDBY/ON (SYSTEM POWER on the remote control) to turn on the power of this unit.



Front panel

or



Remote control

The level of the main volume, and then the current DSP program name appear on the front panel display.

- 2 Turn on the video monitor connected to this unit.

ON-SCREEN DISPLAY (OSD)

You can display the operation information for this unit on a video monitor. If you display the SET MENU and DSP program parameter settings on a monitor, it is much easier to see the available options and parameters than it is by reading this information on the front panel display.



- If a video source is being reproduced, the OSD is superimposed over the image.
- The OSD signal is not output to the OUT (REC) jack, and will not be recorded with any video signal.
- You can set the OSD to turn on (blue background) or off when a video source is not being reproduced (or the source component is turned off) by using “13 DISPLAY SET” on the SET MENU (see page 60).

OSD Modes

You can change the amount of information the OSD shows.

Full display

This mode always shows the DSP program parameter settings on the video monitor.

Short display

This mode briefly shows the same contents as the front panel display at the bottom of the screen and then disappears.

Display off

This mode briefly shows the “DISPLAY OFF” message at the bottom of the screen and then disappears. Afterwards, no changes to operations appear on the monitor except those of the ON SCREEN button.



Full display

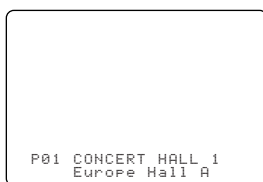

Short display



- When you choose the full display mode, INPUT </>, VOLUME and some other types of operation information are displayed at the bottom of the screen in the same format as that for the front panel display.
- The SET MENU and test tone display appear regardless of the OSD mode.

Selecting the OSD Mode

1 Turn on the video monitor connected to this unit.

2 Press ON SCREEN on the remote control repeatedly to change the display mode.

The OSD mode changes in the following order: full display, short display, and display off.

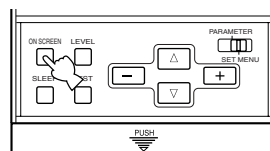

Notes

- If you choose a video input source that has a component connected to both the S VIDEO IN and composite VIDEO IN jacks, and both the S VIDEO OUT and composite VIDEO OUT jacks are connected to a video monitor, the video signal is output to both the S VIDEO OUT and VIDEO OUT jacks. However, the OSD is carried only on the S-video signal. If no video signal is input, the OSD is carried on both the S-video and composite video signals.
- If your video monitor is connected only to the COMPONENT VIDEO jacks of this unit, the OSD is not shown. Make sure to connect your video monitor to the COMPONENT VIDEO jacks and either VIDEO or S VIDEO jacks if you want to see the OSD.
- Playing back video software that has an anti-copy signal or video signals with a lot of noise may produce unstable images.

SPEAKER MODE SETTINGS

This unit has 6 SPEAKER SET items on the SET MENU that you must set according to the number of speakers in your configuration and their size. The following table summarizes these SPEAKER SET items, and shows the initial settings as well as other possible settings.

Summary of SPEAKER SET Items 1A through 1F

Item	Description	Control value (default setting indicated in bold)
1A CENTER SP	Selects the output mode according to whether or not a center speaker is being used and its performance.	LRG /SML/NONE
1B MAIN SP	Selects the output mode according to the performance of the main speakers.	LARGE /SMALL
1C REAR L/R SP	Selects the output mode according to whether or not rear L/R speakers are being used and their performance.	LRG /SML/NONE
1D REAR CT SP	Selects the output mode according to whether or not a rear center speaker is being used and its performance.	LRG /SML/NONE
1E LFE/BASS OUT	Selects the speaker according to use for LFE signal output and low bass signal.	SWFR/ MAIN / BOTH
1F MAIN LEVEL	Selects the main speaker level.	Normal /-10 dB

If the initial settings shown in the above table are not appropriate for your speaker configuration, change settings following the steps described in “1 SPEAKER SET” from page 51 to 54.

ADJUSTING THE SPEAKER OUTPUT LEVELS

This section explains how to adjust the speaker output levels by using the test tone generator. When this adjustment is made, the output level heard at the listening position will be the same from each speaker. This is important for the best performance of the digital sound field processor, and various decoders (Dolby Digital, Dolby Pro Logic, Dolby Pro Logic II, DTS, DTS ES, and DTS Neo: 6).

Note

- Since this unit cannot enter the test mode while headphones are connected to this unit, be sure to unplug the headphones from the PHONES jack when using the test tone.

Before You Begin

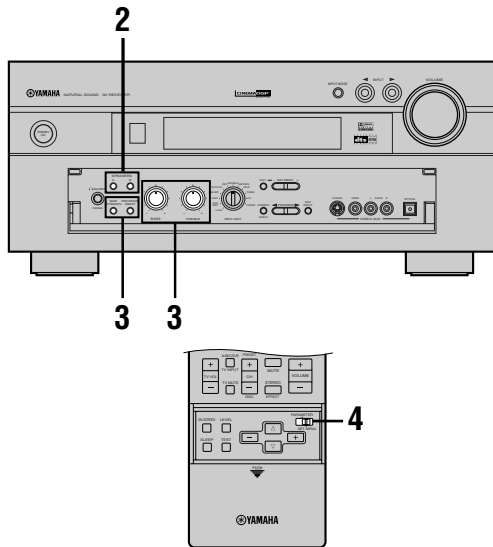

1 Turn on the video monitor connected to this unit.

2 Press **SPEAKERS A** or **B** to select the main speakers to be used.

If you are using two sets of the main speakers, press both A and B.

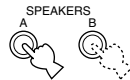

3 Set the **BASS** and **TREBLE** controls on the front panel to the center position and turn off **BASS EXTENSION** and **PROCESSOR DIRECT** by pressing the buttons.

“BASS EXT. OFF” and “P. DIRECT OFF” appear on the front panel display.

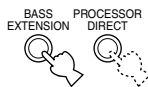
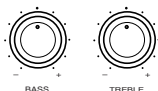

Set to OFF.

4 Set **PARAMETER/SET MENU** on the remote control to **PARAMETER**.



Using the Test Tone (TEST DOLBY SUR.)

Use the test tone to balance the output levels of the 6 speakers required for a surround sound system. The adjustment of each speaker output level should be made at your listening position with the remote control.

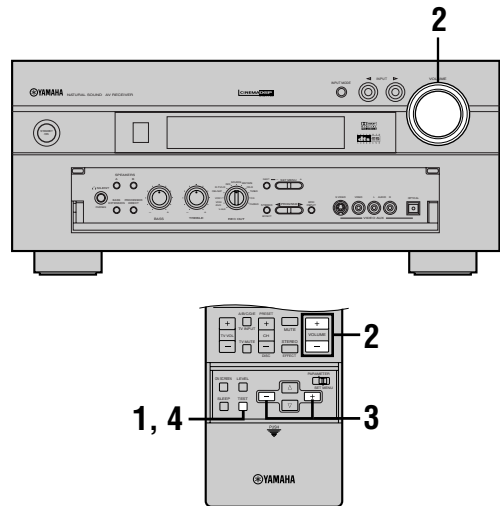

1 Press **TEST** to output the test tone.



2 Adjust the volume so you can hear the test tone.

The test tone is heard from the left main speaker, center speaker, right main speaker, right rear speaker, rear center speaker and left rear speaker in order. The tone is produced for 2.5 seconds each time.

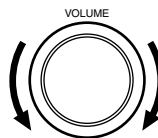

Front panel

or



Remote control

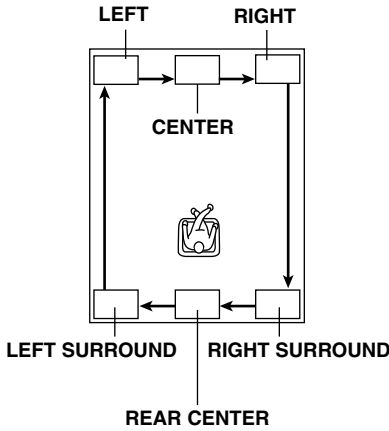

The state of the test tone output is also shown on the monitor by an image of the audio listening room. This is convenient for adjusting each speaker level.

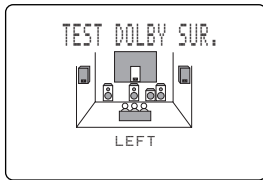

Front panel display also indicates from which speaker the test tone is output in the order of TEST LEFT→TEST CENTER→TEST RIGHT→TEST R SUR.→TEST REAR CNTR→TEST L SUR.

Note

- If the test tone cannot be heard, turn down the volume, set this unit in the standby mode and check the speaker connections.

3 Press **-/+** repeatedly to adjust the output level of the effect speakers so that the output level coming from each speaker is the same.

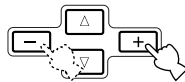

While adjusting, the test tone is heard from the selected speaker.



- You can stop the sequence temporarily by holding down Δ / ∇.

4 When the adjustment is complete, press **TEST** to stop the test tone.



Notes

- The tonal quality of the center speaker can be adjusted by using “5 CENTER GEQ” on the SET MENU (see page 55).
- If “1A CENTER SP” on the SET MENU is set to NONE, the center channel sound is automatically output from the left and right main speakers.
- If “1C REAR L/R SP” on the SET MENU is set to NONE, the output level of the rear right, left and center speakers cannot be adjusted in step 3. The test tone will be circulated in the order of LEFT→CENTER→RIGHT→LEFT..., skipping the rear right and left speakers and the rear center speaker.
- If “1D REAR CT SP” on the SET MENU is set to NONE, the out level of the rear center speaker cannot be adjusted in step 3. The test tone will be circulated in the order of LEFT→CENTER→RIGHT→RIGHT SURROUND→LEFT SURROUND→LEFT ..., skipping the rear center speaker.



- It is not necessary to readjust the speaker level once it is set as long as you do not change the speakers. You can enjoy listening to or watching the input source with the desired volume by adjusting the volume key.
- You can increase the output levels of the effect speakers (center, left rear and right rear and rear center) to +10 dB. If the output level of these speakers is lower than that of the main speakers even after you have increased the output level of these speakers up to +10 dB, set “1F MAIN LEVEL” on the SET MENU to -10 dB (see page 54). This setting decreases the main speaker output level to about one-third of the normal level. After you have set “1F MAIN LEVEL” on the SET MENU to -10 dB, adjust the levels for the center and rear speakers again.

BASIC PLAYBACK

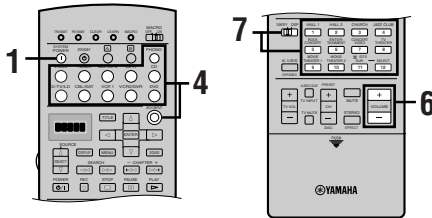
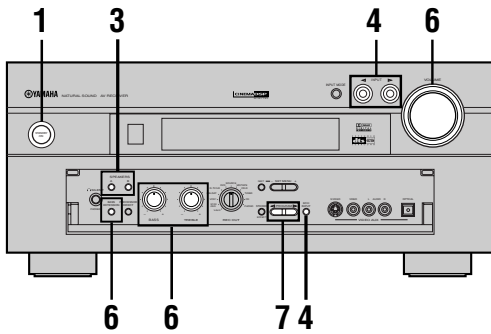

- 1** Press **STANDBY/ON** (**SYSTEM POWER** on the remote control) to turn on the power.

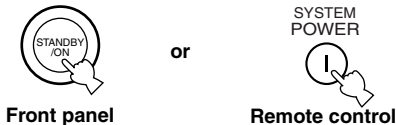

- 2** Turn on the video monitor connected to this unit if you will play video sources.

- 3** Press **SPEAKERS A** or **B** to select the main speakers to be used.

If you are using two sets of main speakers, press both A and B. The speaker indicator(s) for the selected set(s) lights up on the front panel display.

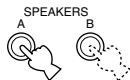

- 4** Press **INPUT** $\triangleleft/\triangleright$ repeatedly (one of the input selector buttons on the remote control) to select the input source.

- The selected input source name and input mode appear on the front panel display for a few seconds.

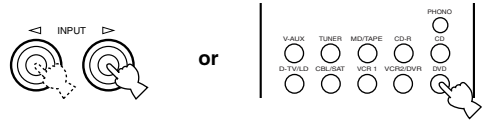

Front panel

Remote control



Selected input source

To select a source connected to the **6CH INPUT** jacks

Press **6CH INPUT** until “6CH INPUT” appears on the front panel display.

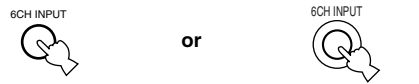

Front panel

Remote control

6CH INPUT

Notes

- If “6CH INPUT” is shown on the front panel display, no other source can be played. To select another input source with **INPUT** $\triangleleft/\triangleright$ (one of the input selector buttons), press **6CH INPUT** to turn off “6CH INPUT” from the front panel display.
- If you want to enjoy an audio source connected to the **6CH INPUT** jacks together with a video source, first select the video source and then press **6CH INPUT**.

5 Start playback or select a broadcast station on the source component.

Refer to the operation instructions for the component.

6 Adjust the volume to the desired output level.

If desired, use BASS, TREBLE and BASS EXTENSION. These controls are only effective for sound from the main speakers.

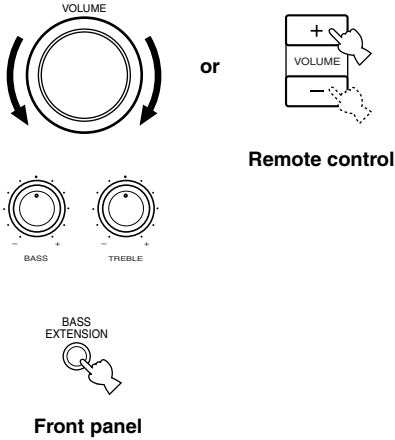

Note

- If the component connected to the VCR 1 OUT, VCR 2/DVR OUT, CD-R OUT and MD/TAPE OUT jacks is turned off, the reproduced sound may be distorted or the volume may be lowered for the characteristics of AV component. In this case, turn on the component.

7 Select a DSP program if desired.

Use PROGRAM <|/> (DSP program buttons on the remote control) to select a DSP program. See pages 30 to 35 for details about the DSP program.

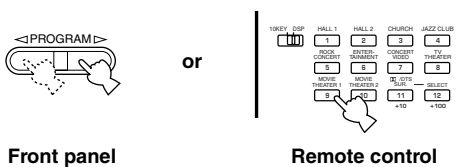

■ BGV (background video) function

The BGV function allows you to combine a video image from a video source with a sound from an audio source. For example, you can enjoy listening to classical music while having beautiful scenery from the video source on the video monitor.

Select a source from the video group and then select a source from the audio group with the input selector buttons on the remote control. This selection for BGV cannot be made with INPUT <|/> on the front panel.

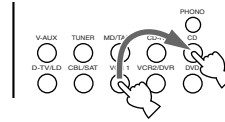

■ To mute the sound

Press MUTE on the remote control.



To resume the audio output, press MUTE again.



- You can also cancel mute to press any operation buttons such as VOLUME +/-.
- During muting, the "MUTE" indicator flashes on the front panel display.

■ When you have finished using this unit

Press STANDBY/ON (STANDBY on the remote control) to set this unit in the standby mode.

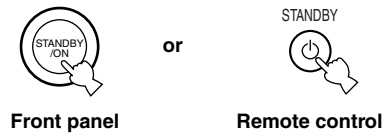

Input Modes and Indications

This unit comes with various input jacks. You can set the priority of the input signal among different types of input signals.

When you turn on the power of this unit, the input mode is set according to “8 INPUT MODE” on the SET MENU (see page 57 for details).

Press INPUT MODE (the input selector button that you have pressed to select the input source on the remote control) repeatedly until the desired input mode is shown on the front panel display.

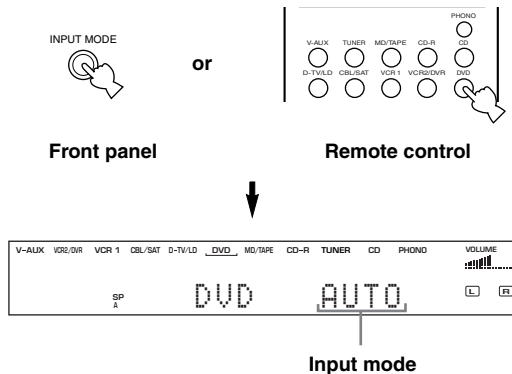

- AUTO:** In this mode, the input signal is automatically selected in the following order:
- 1) Dolby Digital or DTS signal
 - 2) Digital (PCM) signal
 - 3) Analog signal
- DTS:** In this mode, only the digital input signal encoded with DTS is selected even if another signal is input at the same time.
- ANALOG:** In this mode, only the analog input signal is selected even if a digital signal is input at the same time.

Notes

- If digital signals are input from both the COAXIAL and OPTICAL jacks, the digital signal from the COAXIAL jack has precedence over the OPTICAL jack.
- When AUTO is selected, this unit automatically determines the type of signal. If this unit detects a Dolby Digital or DTS signal, the decoder automatically switches to the appropriate setting.
- In playing the disc encoded with Dolby Digital or DTS on some LD or DVD players, the sound output delays for a moment when playback resumes after a search because the digital signal is selected again.
- When playing the LD source that has not been digitally recorded, the sound may not be output for some LD players. In this case, set the input mode to ANALOG.

Notes on the digital signal

The digital input jacks of this unit can also handle 96-kHz sampling digital signals. (To utilize this, use a source that supports 96-kHz sampling digital signals and set the player for digital output. Refer to the operation instructions for the player.) Note the following when a 96-kHz sampling digital signal is input to this unit:

- DSP programs cannot be selected. Sound will be output as normal 2-channel stereo sound from only the left and right main speakers.

Note

- If “1B MAIN SP” on the SET MENU is set to SMALL and “1E LFE/BASS OUT” is set to SWFR, or “1E LFE/BASS OUT” is set to BOTH, the sound is also output from the subwoofer.
- “Adjusting the Level of the Effect Speakers” described on page 61 cannot be made.

Notes on playing DTS-CD/LDs

- If the digital output data of the player has been processed in any way, you may not be able to perform DTS decoding even if you make a digital connection between this unit and the player.
- If you play a source encoded with a DTS signal and set the input mode to ANALOG, this unit may reproduce the noise of an unprocessed DTS signal. In this case, connect the source to a digital input jack and set the input mode to AUTO or DTS.
- If you switch the input mode to ANALOG while playing a source encoded with a DTS signal, this unit reproduces no sound.
- If you play a source encoded with a DTS signal with the input mode set to AUTO;
 - This unit automatically switches to the DTS-decoding mode (The “**dts**” indicator lights up.) after having detected the DTS signal. When playback of the DTS source is completed, the “**dts**” indicator may flash. While this indicator is flashing, only DTS source can be played. If you want to play a normal PCM source soon, set the input mode back to AUTO.
 - The “**dts**” indicator may flash when a search or skip operation is performed while the DTS source is playing back with the input mode set to AUTO. If this status continues for longer than 30 seconds, this unit will automatically switch from “DTS-decoding” mode to PCM digital signal input mode. The “**dts**” indicator will turn off.

Selecting a Sound Field Program

You can enhance your listening experience by selecting a DSP program. There are 11 programs with sub-programs available with this unit. However the selection depends on the input signal format and not all the sub-programs are possible for all input signal formats. For details about each program, see pages 30 to 35.

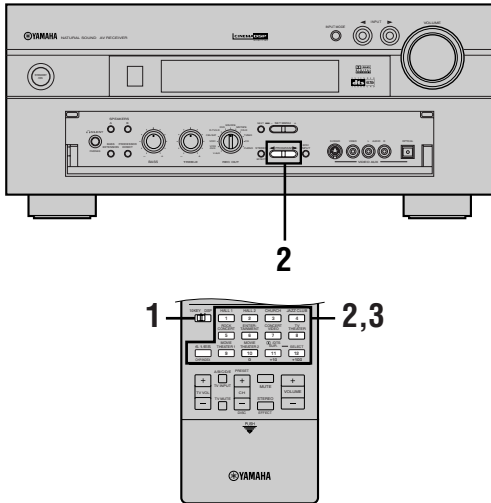

1 Set 10KEY/DSP to DSP on the remote control.



2 Press PROGRAM </> (one of the DSP program buttons on the remote control) to select the desired program.

The name of the selected program appears on the front panel display.

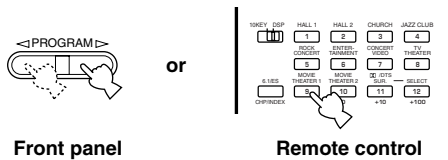

Program name

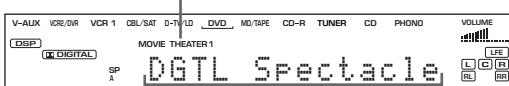

Sub-program name

3 After selecting the desired program, press the same button repeatedly to select the desired sub-program if available.

For example, to select the sub-program “DGTL Sci-Fi”, press MOVIE THEATER 1 repeatedly.

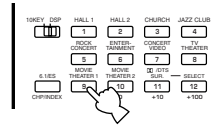

Program name

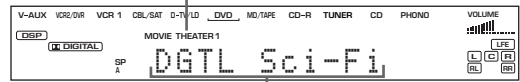

Sub-program name

Notes

- Choose a DSP program based on your listening preference, and not on the name of the program. The acoustics of your listening room affect the DSP program. Minimize the sound reflections in your room to maximize the effect created by the program.
- When you select an input source, this unit automatically selects the last DSP program used with that source.
- When you set this unit in the standby mode, the current source and DSP program are memorized and are automatically selected when you turn on the power again.
- If a Dolby Digital or DTS signal is input when the input mode is set to AUTO, the DSP program (No. 9–11) automatically switches to the appropriate decoding program.
- When a monaural source is being played with PRO LOGIC/Normal or PRO LOGIC/Enhanced, PRO LOGIC II Movie, or Neo: 6 Cinema, no sound will be heard from the main speakers and the rear speakers. Sound can only be heard from the center speaker. However, if “1A CENTER SP” on the SET MENU is set to NONE, the center channel sound is output from the main speakers.
- When a source connected to the 6CH INPUT jacks of this unit is selected, the digital sound field processor cannot be used.
- When 96-kHz sampling digital signals are input to this unit, the DSP program cannot be selected. In this case, the sound is reproduced as normal 2-channel stereo.

Selecting PRO LOGIC II or Neo: 6

You can enjoy the 2-channel sources decoded into five or six discrete channels by selecting PRO LOGIC II or Neo: 6 in the program No. 11.

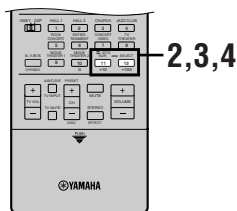
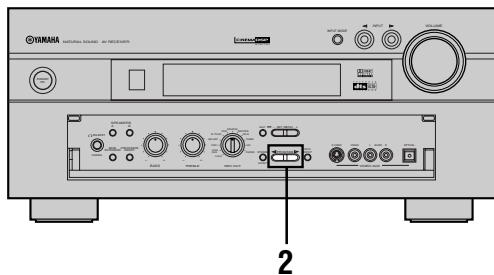

1 Select a 2-channel source and start playback on the source component.

2 Select PRO LOGIC II (Movie/Music) or Neo: 6 (Cinema/Music) by pressing PROGRAM </> on the front panel.



Front panel

(For remote control only)

2 Press the numeric button 11 on the remote control.

The previously selected sub program appears on the front panel display.

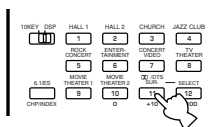

Remote control



3 Press the numeric button 12 repeatedly to select the decoder; PRO LOGIC, PRO LOGIC II or Neo: 6.

The decoder selection switches among PRO LOGIC, PRO LOGIC II and Neo: 6 on the front panel display.

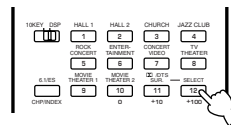

4 After deciding on the decoder (PRO LOGIC II or Neo: 6), select the mode to suit the source by pressing the numeric button 11.

The selection switches as follow;
PRO LOGIC II Movie ↔ PRO LOGIC II Music
(when PRO LOGIC II is selected)

Neo: 6 Cinema ↔ Neo: 6 Music
(when Neo: 6 is selected)

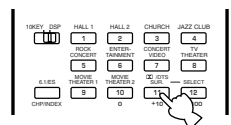

Playing the Dolby Digital Matrix 6.1 or DTS ES software

Press 6.1/ES to turn on the Dolby Digital Matrix 6.1 or DTS ES decoder to listen to the Dolby Digital Matrix 6.1 and DTS ES software with a rear center speaker.



The “6.1/ES” indicator lights up.

The display changes AUTO → Disc6.1 → Mtrx6.1 → OFF each time the 6.1/ES button is pressed.

Notes

- No sound will be output from the rear center speaker if you have set “IC REAR L/R SP” on the SET MENU to NONE.
- The rear center speaker can be used when playing a 5.1-channel source also.

- AUTO:** This mode automatically switches Dolby Digital Matrix 6.1/DTS ES Matrix 6.1/DTS ES Discrete 6.1 depending on the signal in the input source that this unit can detect. Rear center speaker does not work for 5.1 channel sources.
- Disc6.1:** This mode can be selected only when the source with DTS ES Discrete format has been detected.
- Mtrx6.1:** This mode makes 6-channel playback of the input source through the Matrix 6.1 decoder.
- OFF:** Rear center speaker does not work in this mode. (Except for when the DSP program “6ch Stereo” or “Neo: 6” is selected.)

■ Virtual CINEMA DSP and SILENT CINEMA DSP

Virtual CINEMA DSP

With the Virtual CINEMA DSP, you can enjoy all the DSP programs without rear speakers. It creates the virtual speakers to reproduce the natural sound field. The sound field processing is changed to the Virtual CINEMA DSP mode according to the selected DSP program by setting “1C REAR L/R SP” on the SET MENU to NONE.

Note

- This unit is not set in the virtual CINEMA DSP mode even if “1C REAR L/R SP” is set to NONE in the following cases:
 - when the 6ch Stereo, DOLBY DIGITAL Normal, Pro Logic Normal, Pro Logic II, DTS Normal or Neo: 6 program is selected;
 - when the sound effect is turned off;
 - when 6CH INPUT is selected as the input source;
 - when 96-kHz sampling digital signals are input to this unit;
 - when using the test tone; or
 - when connecting the headphones.

SILENT CINEMA DSP

You can enjoy the powerful sound field as if there were actual speakers with the SILENT CINEMA DSP. You can listen to SILENT CINEMA DSP by connecting your headphones to the PHONES jack while the digital sound field processor is on. Enjoy all the DSP program using the headphones. The “SILENT” indicator lights up on the front panel display. (If the sound effect is off, you listen to the source with normal stereo reproduction.)

Notes

- This unit is not set in the SILENT CINEMA DSP mode even if the sound effect is on;
 - when 96-kHz sampling digital signals are input to this unit.
- The sound of LFE channel will be mixed and output from the headphone.

■ Normal Stereo Reproduction

Press STEREO/EFFECT to turn off the sound effect for normal stereo reproduction.
Press STEREO/EFFECT again to turn the sound effect back on.

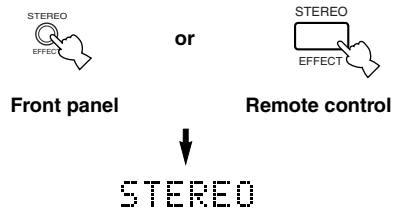

Notes

- If you turn off the sound effect, no sound is output from the center speaker, rear speakers and rear center speaker.
- If you turn off the sound effect while a Dolby Digital or DTS signal is being output, the dynamic range of the signal is automatically compressed and the sounds of the center and rear speaker channels are mixed and output from the main speakers.
- The volume may be greatly reduced when you turn off the sound effect or if you set “11 D-RANGE” on the SET MENU to MIN. In this case turn on the sound effect.

■ Displaying the information about the input source

You can display the information such as the type, format and sampling frequency of the signal input from the component connected to this unit.

- 1** Select the input source you want to obtain the information about by pressing an input selector button.

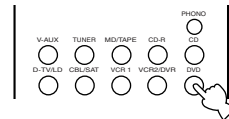

- 2** Press STEREO/EFFECT to light STEREO.



- 3** Press Δ/∇ to display the information about the input signal.

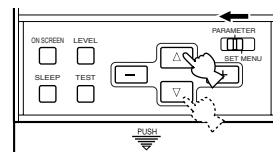

DIGITAL SOUND FIELD PROCESSING (DSP)

Understanding Sound Fields



A sound field is defined as the “characteristic sound reflections of a particular space.” In concert halls and other music venues, we hear early reflections and reverberations as well as the direct sound produced by the artist(s). The variations in the early reflections and other reverberations among the different music venues is what gives each venue its special and recognizable sound quality.

YAMAHA sent teams of sound engineers all around the world to measure the sound reflections of famous concert halls and music venues, and collect detailed sound field information such as the direction, strength, range, and delay time of those reflections. Then we stored this enormous amount of data in the ROM chips of this unit.

■ Recreating a sound field

Recreating the sound field of a concert hall or an opera house requires localizing the virtual sound sources in your listening room. The traditional stereo system that uses only two speakers is not capable of recreating a realistic sound field. YAMAHA’s DSP requires four effect speakers to recreate sound fields based on the measured sound field data. The processor controls the strength and delay time of the signals output from the four effect speakers to localize the virtual sound sources in a full circle around the listener.

Hi-Fi DSP Programs

The following list gives you a brief description of the sound fields produced by each of the DSP programs. Keep in mind that most of these are precise digital recreations of actual acoustic environments.

No.	Program	Features
1	CONCERT HALL 1	Europe Hall A This is a large fan-shaped concert hall with approximately 2500 seats. There is relatively little reflection from the walls, and sound spreads finely and beautifully.
		Europe Hall B This is a large shoe-box type concert hall with less than 2400 seats located in Frankfurt. This hall has a very solid, powerful sound. The listener’s virtual seat is in the center-right section on the first floor.
2	CONCERT HALL 2	U.S.A. Hall C This is a large 2600 seat concert hall in the United States which features a fairly traditional European design. The middle and high frequencies are richly and beautifully reinforced.
		Live Concert A large round concert hall with a rich surround effect. Pronounced reflections from all directions emphasize the extension of sounds. The sound field has a great deal of presence, and your virtual seat is near the center, close to the stage.
3	CHURCH	Freiburg This program recreates the acoustic environment of a big church located in south Germany. The reverberation delay is very long while the early reflections are smaller than with other sound field programs.
		Royaumont This program features the sound field created by the refectory (dining hall) of a beautiful medieval Gothic monastery located in Royaumont on the outskirts of Paris.

No.	Program		Features
4	JAZZ CLUB	Village Gate	This is the sound field at a jazz club in New York. It is in a basement and has a relatively spacious floor area. The listener's virtual seat is at the center left of the hall.
		The Bottom Line	This is the sound field at stage front in "The Bottom Line", a famous New York jazz club. The floor can seat 300 people to the left and right in a sound field offering a real and vibrant sound.
5	ROCK CONCERT	The Roxy Theatre	The ideal program for lively, dynamic rock music. The data for this program was recorded at LA's "hottest" rock club. The listener's virtual seat is at the center-left of the hall.
		Arena	A classic shoe-box type concert hall. This program gives you long delays between direct sounds and effect sounds, with the extraordinarily spacious feel of a large arena.
6	ENTERTAINMENT	Disco	This program recreates the acoustic environment of a lively disco in the heart of a big city. The sound is dense and highly concentrated.
		6ch Stereo	Using this program increases the listening position range. This is a sound field suitable for background music at parties.

CINEMA-DSP

Sound Design of CINEMA-DSP

Filmmakers intend the dialog to be located right on the screen, the effect sound a little farther back, the music spread even farther back, and the surround sound around the listener. Of course, all of these sounds must be synchronized with the images on the screen.

CINEMA-DSP is an upgraded version of YAMAHA DSP specially designed for movie soundtracks. CINEMA-DSP integrates the DTS, Dolby Digital, and Dolby Pro Logic surround sound technologies with YAMAHA DSP sound field programs to provide the surround sound field. It recreates the most complete movie sound design in your audio room. In CINEMA-DSP sound field programs, YAMAHA's exclusive DSP processing is added to the right and left Main and Center channels, so the listener can enjoy realistic dialogue, depth of sound, smooth transition between sound sources, and a surround sound field that goes beyond the screen.

When a DTS or Dolby Digital signal is detected, the CINEMA-DSP sound field processor automatically chooses the most suitable sound field program for that signal.

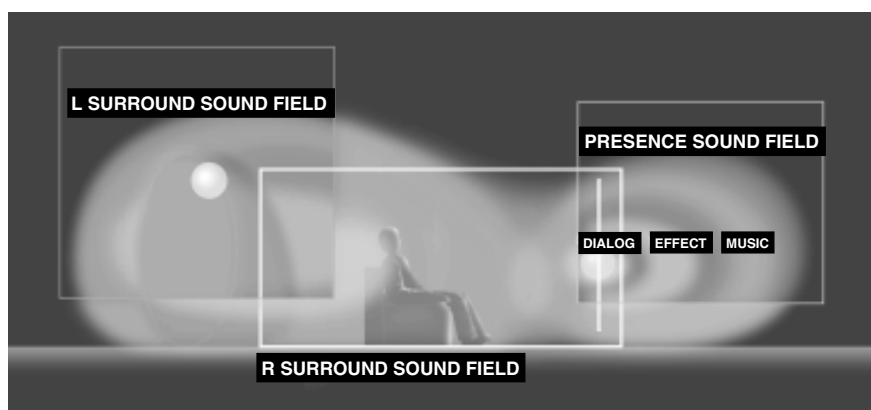

In addition to the DSP, this unit is equipped with various precise decoders; Dolby Pro Logic/Pro Logic II/DTS Neo: 6 decoder for 2-channel sources, Dolby Digital/DTS decoder for multi-channel sources and Dolby Digital Matrix 6.1 or DTS ES decoder for a rear center channel. You can select the CINEMA-DSP program to optimize these decoders and the DSP sound patterns depending on the input source.

The 6-channel soundtracks found on 70-mm film produce precise sound field localization and rich, deep sound without using matrix processing. This unit's MOVIE THEATER programs provide the same quality of sound and sound localization that 6-channel soundtracks do. The built-in Dolby Digital or DTS decoder brings the professional-quality sound designed for movie theaters into your home. With this unit's MOVIE THEATER programs, you can recreate a dynamic sound that gives you the feeling of being at a public theater in your listening room by using Dolby Digital or DTS technology.

■ Dolby Digital/DTS + DSP sound field effect

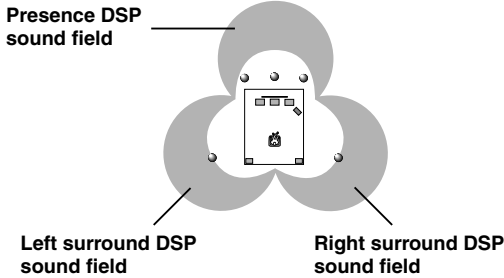

These programs use YAMAHA's tri-field DSP processing on each of the Dolby Digital or DTS signals for the front, left surround and right surround channels. This processing enables this unit to reproduce the immense sound field and surround expression of a Dolby Digital- or DTS-equipped movie theater without sacrificing the clear separation of all channels.

■ Dolby Digital Matrix 6.1/DTS ES + DSP sound field effect

These programs provide you with the maximum experience of the spacious surround effects since an extra rear center DSP sound field created from the rear center channel is added.

■ Dolby Pro Logic + DSP sound field effect

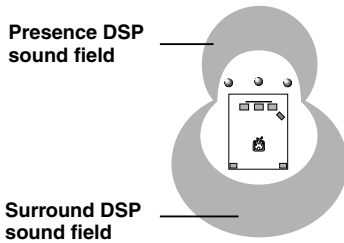

Most movie software has 4-channel (left, center, right and surround) sound information encoded by Dolby Surround matrix processing and stored on the left and right tracks. These signals are processed by the Dolby Pro Logic decoder. The MOVIE THEATER programs are designed to recreate the spaciousness and delicate nuances of sound that tend to be lost in the encoding and decoding processes.

■ Dolby Pro Logic II /DTS Neo: 6

Dolby Pro Logic II and DTS Neo: 6 equipped on this unit decode the 2-channel Dolby Surround software into five discrete full-range channels (3 channels in front and 2 or 3 channels in rear). They also provide two modes; MOVIE/ CINEMA for movies and MUSIC for 2-channel source.

CINEMA-DSP Programs

■ For movie programs: No. 9 to 11

According to the input signal format, this unit automatically chooses the appropriate decoder and DSP sound field pattern.

Table of Program Names for Each Input Format

No.	Input Program	2 channel	5.1 channel		6.1 channel *1	
		Stereo	DOLBY DIGITAL	DTS	DOLBY DIGITAL	DTS ES
9	MOVIE THEATER 1	70 mm Spectacle	DGTL Spectacle	DTS Spectacle	Spectacle 6.1	Spectacle ES
		70 mm Sci-Fi	DGTL Sci-Fi	DTS Sci-Fi	Sci-Fi 6.1	Sci-Fi ES
10	MOVIE THEATER 2	70 mm Adventure	DGTL Adventure	DTS Adventure	Adventure 6.1	Adventure ES
		70 mm General	DGTL General	DTS General	General 6.1	General ES
11	DOLBY DIGITAL	—	Normal	—	Matrix 6.1	—
		—	Enhanced	—	Enhanced 6.1	—
	DTS DIGITAL SUR	—	—	Normal	—	ES Matrix 6.1 ES Discrete 6.1 *2
		—	—	Enhanced	—	Enhanced ES
	PRO LOGIC	Normal	—	—	—	—
		Enhanced	—	—	—	—
	PRO LOGIC II	Movie	—	—	—	—
		Music	—	—	—	—
	DTS Neo: 6	Cinema	—	—	—	—
		Music	—	—	—	—

*1 means the 6.1/ES decoder is ON.

*2 means the DTS ES software encoded with Discrete 6.1 is input.



- If a Dolby Digital signal or DTS signal is input when the input mode is set to AUTO, the DSP program will be automatically switched to the Dolby Digital playback sound field or DTS playback sound field.
- If Dolby Digital Surround EX software or DTS ES software is played when AUTO is selected by pressing the 6.1/ES button on the remote control, the Dolby Digital Matrix 6.1 or DTS ES decoder usually turns on and the corresponding DSP program is selected.
- 6.1/ES on the remote control can be used to play Dolby Digital or DTS 5.1 channel sources with rear center speaker. In this case the program name changes to the corresponding name for 6.1 channel.
- When playing 6.1 channel source with 6.1/ES on the remote control off, the program name changes to the corresponding name for 5.1 channel.

Note

- The “” indicator does not light up when selecting the program No. 11 except for the Enhanced mode.

The following list gives you a brief description of the sound fields produced by each of the DSP programs. Keep in mind that most of these are precise digital recreations of actual acoustic environments.

Note

- Select the DSP program that you feel sounds best regardless of the name and description given for it below.

No.	Program		Features
9	MOVIE THEATER 1	Spectacle	This program creates the extremely wide sound field of a 70-mm movie theater. It precisely reproduces the source sound in detail, making both the video and the sound field incredibly real. This is ideal for any kind of video source encoded with Dolby Surround, Dolby Digital or DTS (especially large-scale movie productions).
		Sci-Fi	This program clearly reproduces dialog and sound effects in the latest sound form of science fiction films, thus creating a broad and expansive cinematic space amid the silence. You can enjoy science fiction films in a virtual-space sound field that includes Dolby Surround, Dolby Digital and DTS-encoded software employing the most advanced techniques.
10	MOVIE THEATER 2	Adventure	This program is ideal for precisely reproducing the sound design of the newest 70-mm and multichannel soundtrack films. The sound field is made to be similar to that of the newest movie theaters, so the reverberations of the sound field itself are restrained as much as possible.
		General	This program is for reproducing sounds from 70-mm and multichannel soundtrack films, and is characterized by a soft and extensive sound field. The presence sound field is relatively narrow. It spatially spreads all around and toward the screen, restraining the echo effect of conversations without losing clarity.
11	Enhanced Mode		This program ideally simulates the multi-surround speaker systems of the 35-mm film theaters. Dolby Pro Logic decoding, Dolby Digital decoding or DTS decoding and digital sound field processing create precise effects without altering the original sound orientation. The surround effects produced by this sound field wrap around the viewer naturally from the back to the left and right, and toward the screen.

■ For audio-video sources in 2-channel: No. 6 to 8

No.	Program		Features
6	ENTERTAINMENT	Game	This program adds a deep and spatial feeling to video game sounds.
7	CONCERT VIDEO	Pop/Rock	This program produces an enthusiastic atmosphere and lets you feel as if you are at an actual jazz or rock concert.
		Opera	This program provides excellent vocal depth and overall clarity by restraining excessive reverberation. The surround sound field is relatively moderate but it reproduces beautiful sound using data collected from a concert hall.
8	TV THEATER	Mono Movie	This program is provided for reproducing monaural video sources (such as old movies). The program produces the optimum reverberation to create sound depth using only the presence sound field.
		Variety/Sports	Though the presence sound field is relatively narrow, the surround sound field employs the sound environment of a large concert hall. With this program, you can enjoy watching various TV programs such as news, variety shows, music programs, or sports programs.

BASIC RECORDING

REC OUT allows you to record one source while watching and/or listening to another source.

Recording adjustments and other operations are performed from the recording components. Refer to the operation instructions for these components.

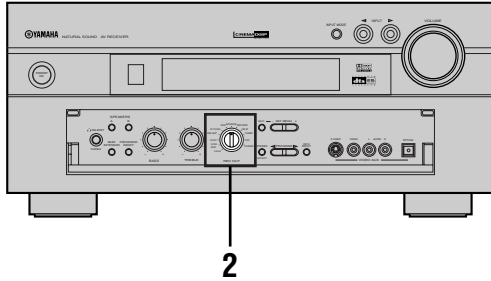

1 Turn on the power to this unit and all connected components.

2 Select the source component you want to record from by using REC OUT.

- To record the current input source that you are watching or listening to, set REC OUT to SOURCE.

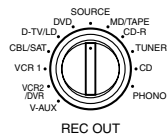

- To record the other source than the one that you are watching or listening to, set REC OUT to the source you want to record.

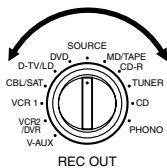

Note

- At this setting, you can change the source to listen to or watch during recording by pressing INPUT <I/O> (one of the input selector buttons on the remote control).

3 Start playback (or select a broadcast station) on the source component.

4 Start recording on the recording component.



- Setting REC OUT to SOURCE and using the BGV function (see page 25) allows the recording of audio and video from a different source.

Notes

- Do a test recording before you start an actual recording.
- When this unit is set in the standby mode, you cannot record between other components connected to this unit.
- The setting of BASS, TREBLE, BASS EXTENSION, VOLUME, "3 L/R BALANCE" on the SET MENU and DSP programs does not affect the recorded material.
- A source connected to the 6CH INPUT jacks of this unit cannot be recorded.
- S-video and composite video signals pass independently through this unit's video circuits. Therefore, when recording or dubbing video signals, if your video source component is connected to provide only an S-video (or only a composite video) signal, you can record only an S-video (or only a composite video) signal by your VCR.
- A given input source is not output on the same REC OUT channel. (For example, the signal input from VCR 1 IN is not output on VCR 1 OUT.)
- Check the copyright laws in your country to record from records, CDs, radio, etc. Recording of copyrighted material may infringe copyright laws.

If you playback a video source that uses scrambled or encoded signals to prevent it from being dubbed, the picture itself may be disturbed due to those signals.

Special considerations when recording DTS software

The DTS signal is a digital bitstream. Attempting to digitally record the DTS bitstream will result in noise being recorded. Therefore, if you want to use this unit to record sources that have DTS signals recorded on them, the following considerations and adjustments need to be made.

For LDs, DVDs and CDs encoded with DTS, when your player is compatible with the DTS format, follow its operation instruction to make a setting so that the analog signal will be output from the player.

Timer playback/recording

This unit can perform playback or recording with an external timer (not supplied). Refer to the operation instruction for the component and the timer to be used.

Notes

- The stored data such as input source will be reflected in the playback or recording with the timer.
- If you do not want any sound output during the recording with a timer, turn the volume down.

Memory back-up

The memory back-up circuit prevents the stored data (input source, volume level, set menu settings and so on) from being lost even if this unit is in the standby mode (disconnected from the AC outlet). However if the timer is turned off for more than one week, the stored data will be lost.

REMOTE CONTROL FEATURES

The remote control can operate other A/V components of YAMAHA and other manufacturers as well as this unit. To control those components, you must set up remote control with the manufacturer codes.

This remote control also has two sophisticated features: Learn and Macro. The Learn feature allows it to acquire functions from the remote controls of other components in your system (or other household appliances) equipped with an infrared remote control receiver. The Macro feature allows you to program a series of operations in sequence for operation by a single button, or to use the factory-set macros to operate other YAMAHA components. These features make it possible for you to reduce the number of remote control in your entertainment room.

Notes

- For the operating distance of the remote control and notes about batteries, see pages 3 and 7.
- For the name and function of each part and button, see pages 6 and 7.

Control Area

Control area of this unit

The control area of this unit is the shaded area shown below. You can use the functions within this area no matter which component control area is selected.

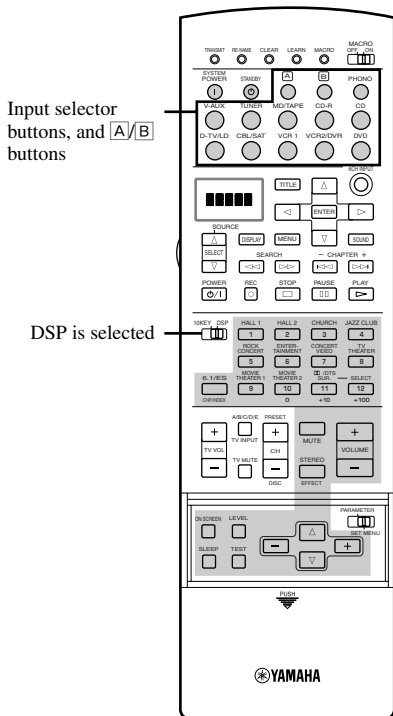

Control area for each component

The component control area is the shaded area shown below. Each component has different functions for the operation buttons in the component control area. The component which has been chosen by pressing an input selector button or SOURCE SELECT Δ/∇ can be controlled and the display window shows the corresponding name of the component to be operated.

Input selector buttons and Δ/∇ buttons switch the control area for each component. * Δ/∇ buttons are to operate the other components that are not connected to this unit. Δ and ∇ buttons cannot be used as an input selector button.

Factory setting:

- Δ LD player
- ∇ Satellite tuner

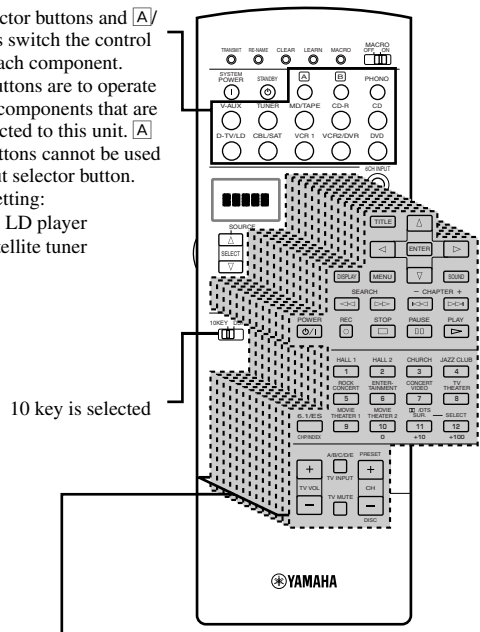

Component control area

There are 13 component control areas (See pages 45 to 49). You can set up the manufacturer code and program other remote control functions in each area. See pages 38 to 39.

Setting the Manufacturer Code

You can control other components by setting a manufacturer code. A code can be set up in each component control area.

The following table shows factory-set component (Library: component category) and the manufacturer code for each area. If you are to make a setting for different component from the factory setting, change the library as described in step 3 on right.

Input area	Component category (Library)	Manufacturer
A	LD	YAMAHA
B	SATELLITE TUNER	-
PHONO	TV	-
TUNER	TUNER	YAMAHA
CD	CD	YAMAHA
V-AUX	VCR	-
CBL/SAT	CABLE	-
MD/TAPE	MD	YAMAHA
CD-R	CD-R	YAMAHA
D-TV/LD	TV	-
VCR 1	VCR	-
VCR 2/DVR	VCR	-
DVD	DVD	YAMAHA

1 Press an input selector button, **A** or **B** to select the source component you want to set up.

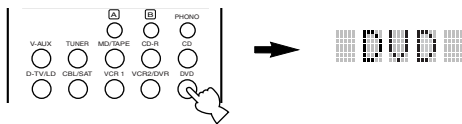

2 Press and hold **LEARN** for about 3 seconds by using a ballpoint pen or similar object. "SETUP" and the selected component name appear alternately in the display window.

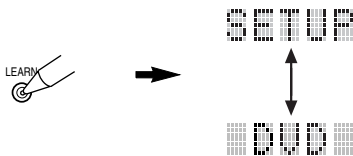

Notes

- Press LEARN for at least 3 seconds, otherwise the learning process is started.
- If you do not press any button within 30 seconds during step 3, the setup process is canceled. If this happens, start over from step 2.

3 Press Δ / ∇ to select the name of your component's manufacturer.

You will find the names of most worldwide audio-video manufacturers in alphabetical order in the display window.

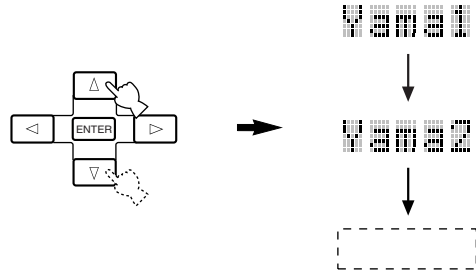

If you want to change a library (component category), press \leftarrow / \rightarrow . You can set a different component from the input selector name.

Library choices: DVD, LD, CD, CD-R, MD, TAPE, TUNER, AMP, TV, CABLE, DBS, SAT, VCR



Note

If the manufacturer of your component has more than one codes, try each of them until you find the correct one as checking if it works following step 4.

4 Press one of the buttons shaded below to check if it works for the component being set. If it does, the manufacturer code setting has been correctly made.

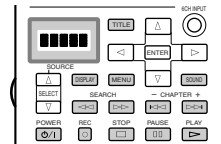

- If you continuously want to set up another code for another component, press ENTER and repeat steps 1, 3 and 4.

5 Press **LEARN** again to exit from the setup mode.



Notes

- If you have already programmed a remote control function for a button, the function by learning or macro programming takes priority over the setup manufacturer code's function.
- "ERROR" appears in the display window under the following circumstances:
 - when pressing a button other than the cursor and ENTER;
 - when pressing more than one button at once; or
 - when MACRO ON/OFF, 10KEY/DSP or PARAMETER/SET MENU is switched to another position.

Programming a New Remote Control Function (Learn Feature)

If you want to program functions not included in the basic operations covered by the manufacturer code, or a manufacturer code is not available, the following procedure needs to be performed. The possible programming area is the same as a component control area, so the buttons are programmable independently for each source component area.

Note

- This remote control transmits infrared rays. If the other remote control also uses infrared rays, this remote control can learn most of the other remote control's functions. However, you may not be able to program some special signals or extremely long transmissions. (Refer to the operation instructions for the other remote control.)

1 Set 10KEY/DSP to 10KEY.



2 Press an input selector button, **A** or **B** to select a source component.

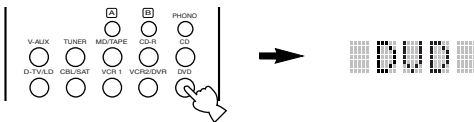

3 Place this remote control and the other remote control about 5 to 10 cm apart on a flat surface so that their infrared transmitters are aimed at each other.

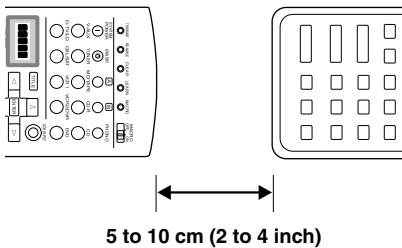

4 Press LEARN by using a ballpoint pen or similar object.

Do not press and hold LEARN longer than three seconds. Otherwise this unit enters the manufacturer code setting mode.

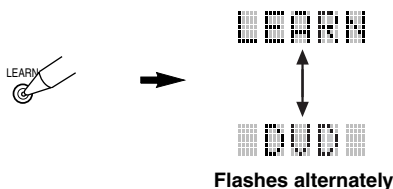

Note

- If you do not press any button within 30 seconds during steps 5 and 6, the learning process is canceled. If this happens, start over from step 4.

5 Press the button for which you want to program the new function. "LEARN" is displayed.

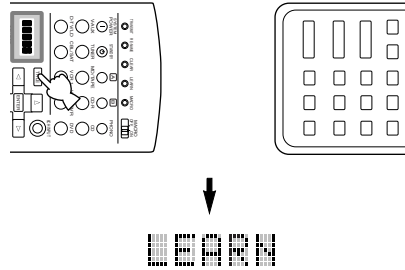

6 Press and hold the button on the other remote control that has the function you want to program into this remote control until "OK" appears in the display window.

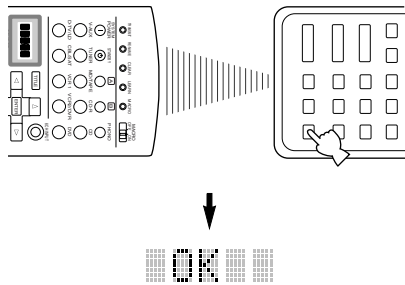

Notes

- "NG" appears in the display window when programming has not been done correctly. In this case, start over from step 5.
- This remote control can learn approximately 120 functions. However depending on the signals learned, "FULL" may appear in the display window much earlier than this number. In this case, clear unnecessary programmed functions to make further learning on the remote control.

7 Repeat steps 5 and 6 to program additional functions.

8 Press LEARN again to exit from the learning mode.



Notes

- It is also possible to program in the control area of this unit with 10KEY/DSP set to DSP. However, if you program functions in this area, you cannot control this unit and select a DSP program.
- If the batteries in the other remote control are weak, they may not have enough power to transmit signals to this remote control.
- When the remote controls are either too close together or too far apart, you may not be able to program this remote control.
- Direct sunlight interferes with infrared rays.
- "ERROR" appears in the display window in the following circumstances:
 - when pressing more than one button at once; or
 - when MACRO ON/OFF is switched to another position.

Using the Macro Feature

The Macro feature makes it possible to perform a series of operations by pressing just one button. For example, when you want to play a CD, normally you would turn on the components, select the CD input, and press the play button to start playback. The Macro feature lets you perform all those operations by simply pressing the CD macro button. The macro buttons (the input selector buttons, **[A]** and **[B]** buttons, SYSTEM POWER and STANDBY) are factory set with macro programs. You can also program your own macros (see pages 41 and 42).

Press one of the macro buttons



Automatically transmits signals of each button sequentially



(CD area)

Macro buttons		First	Second	Third
PHONO			PHONO	-
V-AUX			V-AUX	-
TUNER			TUNER (*4)	-
MD/TAPE			MD/TAPE	PLAY (MD/TAPE area) (*3)
CD-R			CD-R	PLAY (CD-R area) (*3)
CD			CD	PLAY (CD area) (*3)
D-TV/LD			D-TV/LD	-
CBL/SAT			CBL/SAT	-
VCR 1			VCR 1	PLAY (VCR 1 area) (*3)
VCR2/DVR			VCR2/DVR	PLAY (VCR 2/DVR area) (*3)
DVD			DVD	PLAY (DVD area) (*3)
[A]			-	-
[B]			-	-
SYSTEM POWER		SYSTEM POWER (*1)	POWER (D-TV/LD area) (*2)	-
STANDBY		STANDBY	-	-

- *1 In order to turn on some components (including YAMAHA components) connected to this unit, connect those components to the AC OUTLETS on the rear panel. (Power control may not be synchronized with this unit depending on the component. For details, please refer to the operation instruction for the connected component.)
- *2 If the macro you select includes power control functions, the component may be turned off if it is already on when you press the macro button. For example, if your TV is on and you press the SYSTEM POWER macro button, the TV is turned off.
- *3 Playback can be started with any YAMAHA remote control-compatible MD recorders, CD players, CD recorders, DVD players, and LD players. When using macros to operate other components, it is either necessary to program the PLAY button on the control area of that component (see page 39) or to set up a manufacturer code (see page 38).
- *4 When TUNER is selected as the input source, this unit receives the last station when this unit is set in the standby mode.

■ Operating the macro

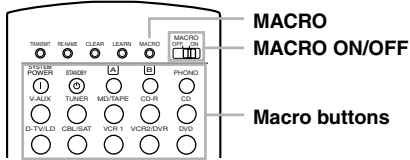

1 Set **MACRO ON/OFF** to **ON**.

2 Press a macro button.

Notes

- When you have finished using the Macro feature, set **MACRO ON/OFF** to **OFF**.
- While this unit is carrying out a macro program, this unit does not receive any other button's function until the macro operation has been completed (the **TRANSMIT** indicator stops flashing).
- Continue to aim the remote control at the component the macro is operating until the macro operation has been completed.

■ Programming a macro

You can program your own macros and use the Macro feature to transmit many remote control commands by pressing a single button.

Notes

- The factory-set macro is not cleared when a new macro is programmed for a button. The factory-set macro can be used again when the programmed macro is cleared.
- It is not possible to add a new signal (macro step) to the factory-set macro. Programming a macro changes all macro contents.
- A macro programming is used to transmit learning or setup (or YAMAHA preset) button signals of this remote control to a macro button. If necessary, set up the manufacturer code or program a function with the remote control for your component.
- This remote control handles button signals that operate continuously, such as volume control, as short time interval codes. Macro programming that include these types of macro steps are therefore not recommended.

1 Press **MACRO** by using a ballpoint pen or similar object.

“MCR ?” appears in the display window.



Note

- If you do not press any button within 30 seconds during steps 2 and 3, the macro programming process is canceled. If this happens, start over from step 1.

2 Press a macro button for which you want to program the macro operation.

The button you chose for programming the macro operation and the selected component name appear alternately in the display window.

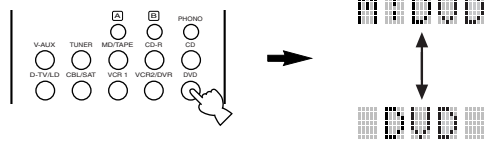

Note

- “AGAIN” appears in the display window when a button other than the macro buttons is pressed.



- If you want to change the source component, use **SOURCE SELECT** Δ / ∇ or input selector buttons. When you use the input selector buttons, selecting the input is programmed as a macro step, whereas **SOURCE SELECT** Δ / ∇ only changes the component.

3 Press the buttons of the functions that you want to include in the macro operation sequence in order.



- You can set up to 10 steps (10 functions). After you have set 10 steps, “FULL” appears and the remote control automatically exits from the macro mode.

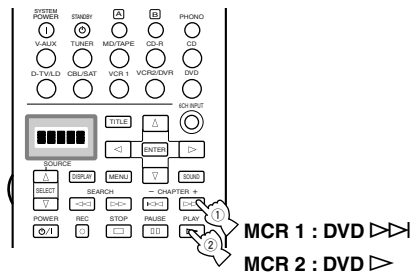

indicate the number of macro steps you entered

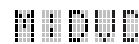

appear alternately so that you can set up the next step



Note

- “NG” appears in the display window when programming has not been done correctly. In this case, start over from step 2.

4 Press **MACRO** again when the operation sequence you want to program is complete.



Note

- "ERROR" appears in the display window under the following circumstances:
 - when pressing more than one button at once; or
 - when MACRO ON/OFF is switched to another position.

Memory back-up

If the remote control is without batteries for more than 3 minutes, or if exhausted batteries remain in the remote control, the contents of the memory may be cleared. When the memory is cleared, insert new batteries, set up the manufacturer code and program any acquired functions that may have been cleared.

Changing the Source Name in the Display Window

You can change the name that appears in the display window on the remote control if you want to use the different name from the original input selector button names. This is useful when different component is set in the input selector button.

1 Press an input selector button, **A** or **B** to select the source component you want to rename.

The selected component name appears in the display window.

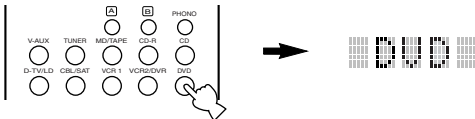

2 Press **RE-NAME** by using a ballpoint pen or similar object.



3 Press **Δ** / **∇** to select and enter a character. Pressing **∇** changes the character in the following order: A to Z, a to z, 0 to 9, space, - (hyphen) and / (slash). (Pressing **Δ** goes in the reverse order.)

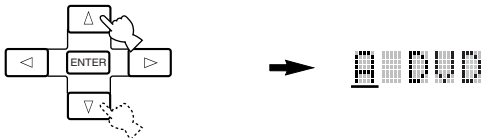

4 Press **◀** / **▶** to move the cursor to the next position.

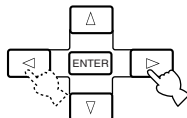

- If you continuously want to rename another source component, press **ENTER** and repeat steps 1, 3 and 4.

5 Press **RE-NAME** again to exit from the renaming mode.



Clearing Learned Functions, Macros, Renamed Source Names, and Setup Manufacturer Codes

1 Press an input selector button, **A** or **B** to select the source component you want to clear the function, Macros, renamed source names or manufacturer codes.

The selected component name appears in the display window.

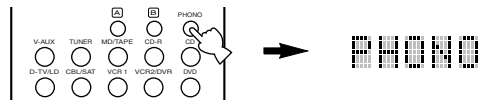

2 Press **CLEAR** by using a ballpoint pen or similar object.



Note

- If you do not press any button within 30 seconds after step 2, the clearing process is canceled. If this happen, start over from step 1.

- 3 Press Δ / ∇ to select the clear mode.**
The mode is shown in the display window in the following order:

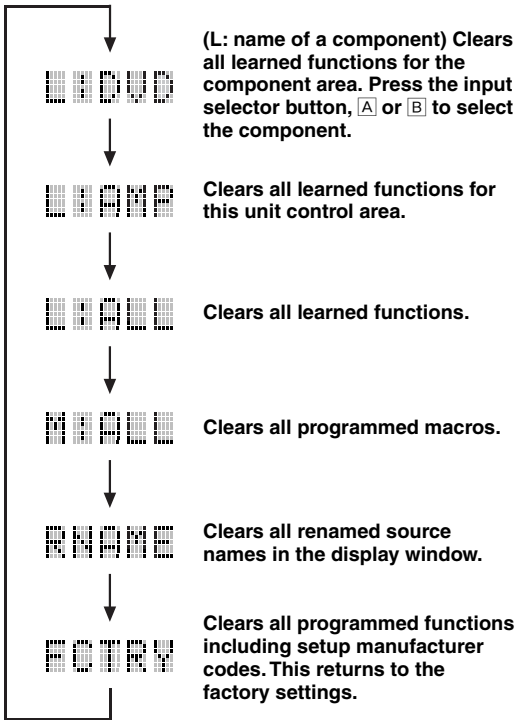

- 4 Press and hold CLEAR again for about 3 seconds.**
“C:OK” appears in the display window.

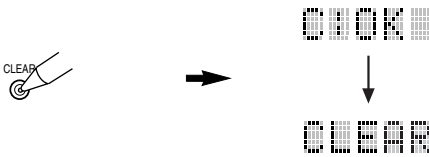

Note

- “C:NG” appears in the display window if the operation is unsuccessful. In this case, start over from step 2.

- 5 Press CLEAR to exit from the clearing mode.**
Once you have cleared a learned function or macro for a button, the button reverts to the factory setting.



Note

- “ERROR” appears in the display window under the following circumstances:
 - when pressing a button other than the cursor and ENTER;
 - when pressing more than one button at once; or
 - when MACRO ON/OFF, 10KEY/DSP or PARAMETER/SET MENU is switched to another position.

Clearing a Learned Function or Macro

You can clear the function learned in a certain programmable button in each area.

To clear a learned function

- 1 Press an input selector button, [A] or [B] to select the source component you want to clear the function.**
The selected component name appears in the display window.

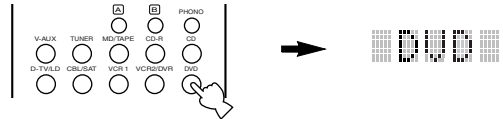

- 2 Press LEARN by using a ballpoint pen or similar object.**
“LEARN” and the selected component name appear alternately in the display window.

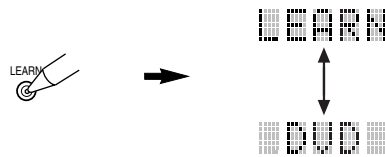

Note

- If you do not press any button within 30 seconds after step 2, the clearing process is canceled. If this happens, start over from step 2.

- 3 Press the button that you want to clear for 3 seconds as pressing CLEAR by using a ballpoint pen or similar object.**
“C:OK” appears in the display window.



- 4 Press LEARN again to exit from the learning mode.**



To clear the macro function

- 1 Press an input selector button, [A] or [B] to select the source component for which you want to clear the function.**
The selected component name appears in the display window.

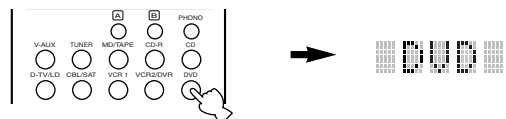

- 2 Press MACRO to clear a programmed macro by using a ballpoint pen or similar object.**



- 3 Press and hold CLEAR by using a ballpoint pen or similar object, and at the same time press the button for which you want to clear the macro for about 3 seconds.**

“C:OK” appears in the display window.

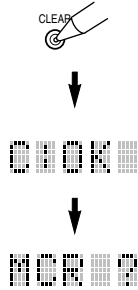

- You can clear other learned functions and macros at this time by holding down CLEAR again and pressing the other buttons for which those learned functions or macros have been programmed.

Note

- “C:NG” appears in the display window if the operation is unsuccessful. In this case, try step 3 again.

- 4 Press MACRO again to exit from the clearing mode.**

Once you have cleared a learned function or macro for a button, the button reverts to the factory setting.



SOURCE SELECT Δ / ∇

You can control another component independently from the input you have selected by pressing an input selector button.

Press SOURCE SELECT Δ / ∇ to choose the component and set the remote control to be used for it.

The display window will show one of the following: (when pressing ∇) OPTN (option), Δ , \square , PHONO, V-AUX, TUNER, MD, CD-R, CD, TV/LD (TV or digital TV/LD), CBSAT (cable TV/satellite tuner), VCR 1, VCR 2, DVD.



- Pressing Δ shows the same in the reverse order, but you cannot select OPTN.

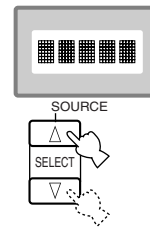

OPTN (option) area

OPTN is an extra component control area that can be programmed with other remote control functions.

Note

- You cannot set up the manufacturer code in this area. See page 38 for the programming procedure.

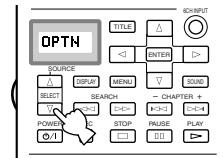

Pressing ∇ always selects OPTN first

Each Component Control Area

The general operational buttons are shown for each area. Some of them may not function depending on the component you have. After setting the manufacturer code, press an input selector button, **A** / **B**, or SOURCE SELECT Δ / ∇ to select a component you want to control.

■ Operating a DVD player (DVD area)

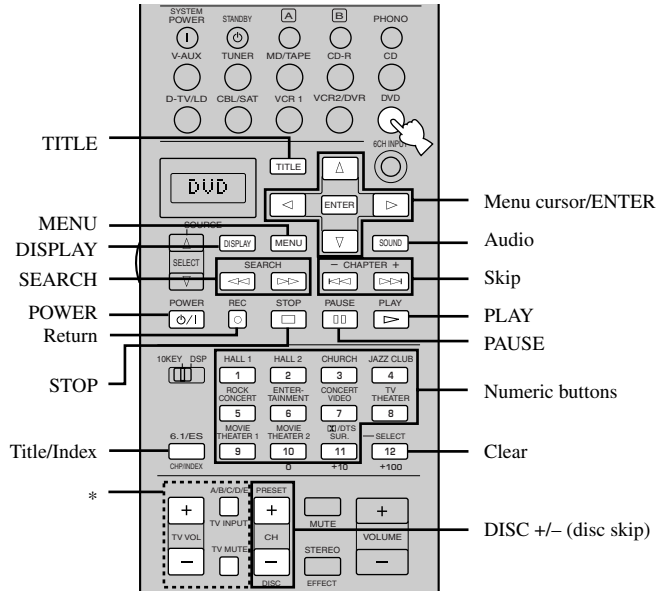

* TV VOL +/-, TV INPUT, and TV MUTE function to operate your TV without switching the input if the manufacturer code is set in D-TV/LD or PHONO. When the manufacturer code for your TV is set up in the both D-TV/LD and PHONO areas, priority is given to the signal in the D-TV/LD area.

■ Operating a VCR (VCR 1 and VCR 2/DVR areas)

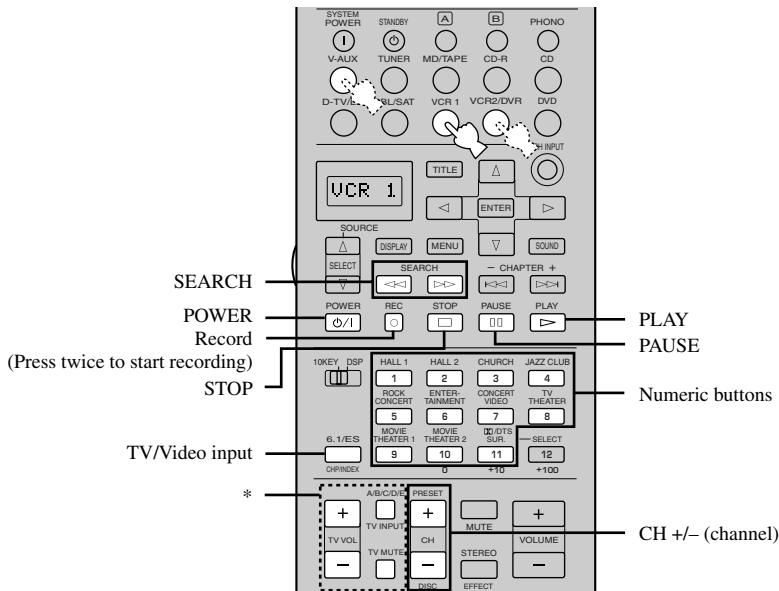

* TV VOL +/-, TV INPUT, and TV MUTE function to operate your TV without switching the input if the manufacturer code is set in D-TV/LD or PHONO. When the manufacturer code for your TV is set up in the both D-TV/LD and PHONO areas, priority is given to the signal in the D-TV/LD area.

■ Operating a TV/digital TV (D-TV/LD area) or a cable TV/satellite TV (CBL/SAT area)

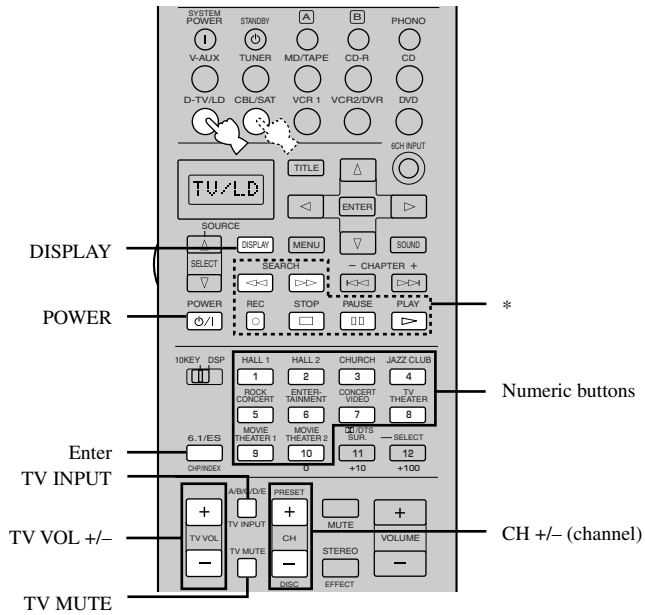

* SEARCH, REC, STOP, PAUSE and PLAY function to operate your VCR without switching the input to VCR 1 if the manufacturer code is set in VCR 1.

■ Operating an LD player (D-TV/LD area)

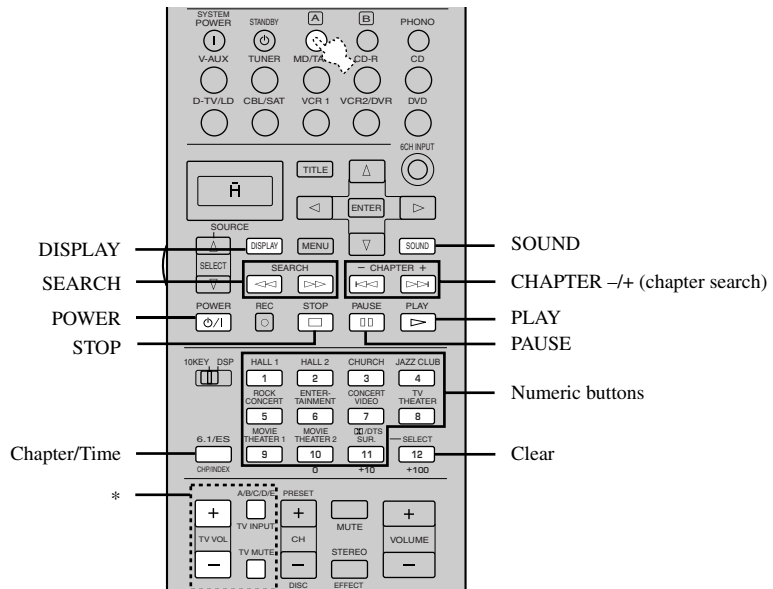

Set the manufacture code for your LD player following the setting procedure described on page 38 because TV is factory-set for this input selector button.

* TV VOL +/-, TV INPUT, and TV MUTE function to operate your TV without switching the input if the manufacturer code is set in PHONO.

■ Operating a CD player (CD area)

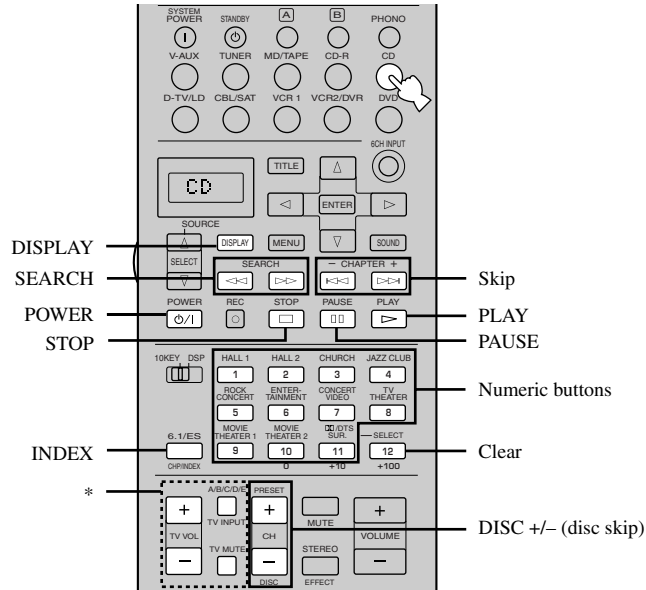

* TV VOL +/-, TV INPUT, and TV MUTE function to operate your TV without switching the input if the manufacturer code is set in D-TV/LD or PHONO. When the manufacturer code for your TV is set up in the both D-TV/LD and PHONO areas, priority is given to the signal in the D-TV/LD area.

■ Operating a CD recorder (CD-R area) or an MD recorder (MD/TAPE area)

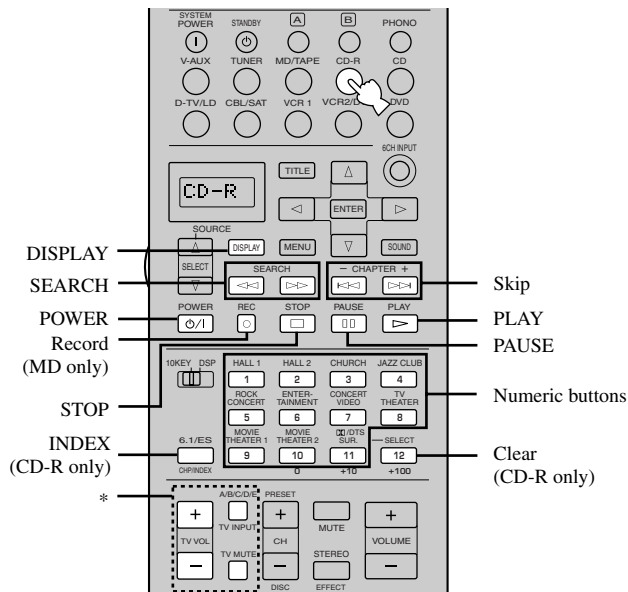

* TV VOL +/-, TV INPUT, and TV MUTE function to operate your TV without switching the input if the manufacturer code is set in D-TV/LD or PHONO. When the manufacturer code for your TV is set up in the both D-TV/LD and PHONO areas, priority is given to the signal in the D-TV/LD area.

■ Operating a tape deck (MD/TAPE area)

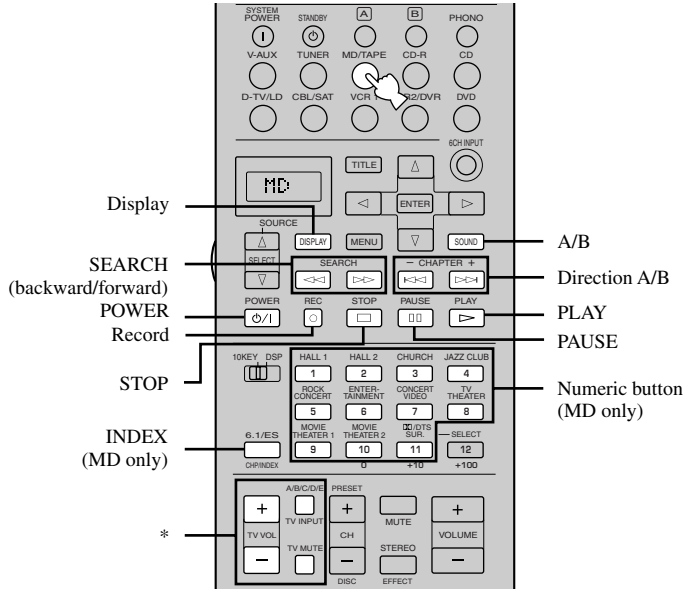

* TV VOL +/-, TV INPUT, and TV MUTE function to operate your TV without switching the input if the manufacturer code is set in D-TV/LD or PHONO. When the manufacturer code for your TV is set up in the both D-TV/LD and PHONO areas, priority is given to the signal in the D-TV/LD area.

■ Operating a tuner (TUNER area)

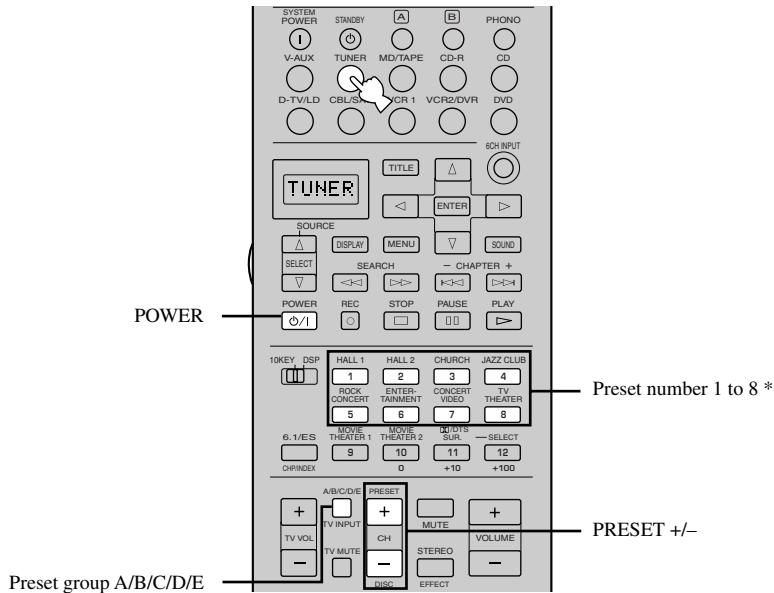

* These buttons function when the manufacturer code "Yama2" is set up.

■ Operating the component set in **A** or **B**

These buttons are not input selector buttons but simply provide the space for an extra component to control with this unit's remote control without making connection to this unit. The white buttons area shown below can be used for the component set in **A** and **B**, and the function for each button differs depending on the component.

YAMAHA LD player is factory-set in **A** and satellite tuner in **B**. However if you want to set other component, set the manufacturer code for the component you want to set in the **A** / **B** button following the manufacturer code setting procedure described on page 38.

The functions of these buttons in the component control area differ for the component you set in **A** or **B**.

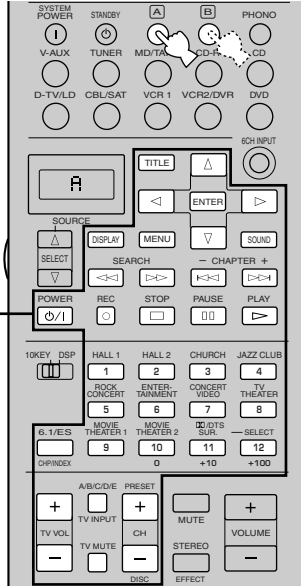

SET MENU

The SET MENU consists of 14 items including the speaker mode setting, center graphic equalizer and parameter initialization features. Choose the appropriate item and adjust or select the values as necessary.



- You can adjust the items on the SET MENU while playing a source.
- We recommend that you adjust the items on the SET MENU while using a video monitor. It is easier to see the video monitor than it is to see the front panel display on this unit while adjusting the items.

Note

- The indication on the front panel display is the abbreviation of the OSD.

- 1 **SPEAKER SET**
 - 1A CENTER SP
 - 1B MAIN SP
 - 1C REAR L/R SP
 - 1D REAR CT SP
 - 1E LFE/BASS OUT
 - 1F MAIN LEVEL
- 2 **LOW FRQ TEST**
- 3 **L/R BALANCE**
- 4 **HP TONE CTRL**
- 5 **CENTER GEQ**
- 6 **INPUT RENAME**
- 7 **I/O ASSIGNMENT**
 - 7A CMPNT-V INPUT
 - 7B OPTICAL OUT
 - 7C OPTICAL IN
 - 7D COAXIAL IN
- 8 **INPUT MODE**
- 9 **PARAM. INI**
- 10 **LFE LEVEL**
- 11 **D-RANGE**
- 12 **SP DELAY TIME**
- 13 **DISPLAY SET**
- 14 **MEMORY GUARD**

Adjusting the Items on the SET MENU

Adjustment should be made with the remote control.

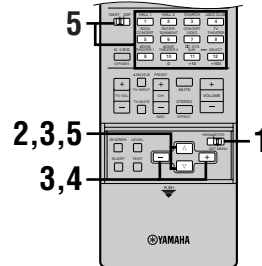

Note

- Some items require extra steps to change to the desired setting.

- 1** Set **PARAMETER/SET MENU** to **SET MENU**.



- 2** Press **Δ / ▽** repeatedly to select the item (1 to 14) you want to adjust.

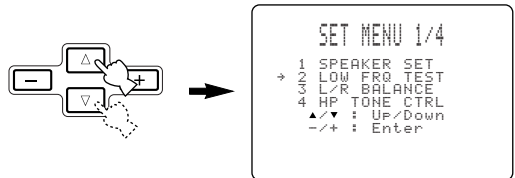

- 3** Press **-/+** once to enter the setup mode of the selected item.

The last setting you adjusted appears on the video monitor or on the front panel display.

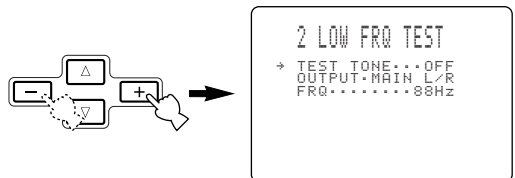

Depending on the item, press **Δ / ▽** to select a sub item.

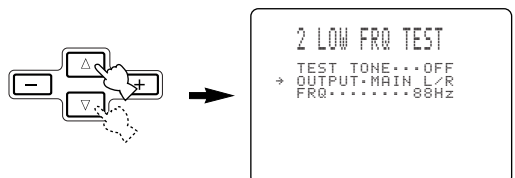

4 Press **-/+** repeatedly to change the setting of the item.

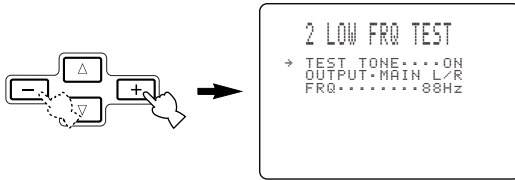

5 Press **Δ / ▽** repeatedly until the current DSP program appears or simply press one of the DSP program group buttons to exit from the SET MENU.

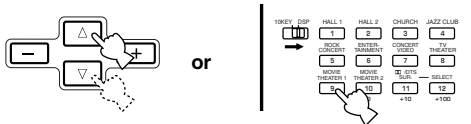

Memory back-up

The memory back-up circuit prevents the stored data from being lost even if this unit is in the standby mode. However if the power cord is disconnected from the AC outlet, or the power supply is cut for more than one week, the stored data will be lost. If so, adjust the items again.

1 SPEAKER SET (speaker mode settings)

Use this feature to select suitable output modes for your speaker configuration.

Notes

- When 96-kHz sampling digital signals are input to this unit, level adjustments in items 1B, 1E and 1F are possible, but those in items 1A, 1C and 1D are not affected.
- When 6CH INPUT is selected as the input source, level adjustments in items 1A through 1E are not affected.

1A CENTER SP (center speaker mode)

By adding a center speaker to your speaker configuration, this unit can provide good dialog localization for many listeners and superior synchronization of sound and images. The OSD shows a large, small or no center speaker depending on how you set this item.

Choices: LRG (large), SML (small), NONE
Initial setting: LRG

LRG

Select this if you have a large center speaker. The entire range of the center channel signal is directed to the center speaker.



SML

Select this if you have a small center speaker. The low-frequency signals (90 Hz and below) of the center channel are directed to the speakers selected with "1E LFE/BASS OUT".



NONE

Select this if you do not have a center speaker. All of the center channel signal are directed to the left and right main speakers.



■ 1B MAIN SP (main speaker mode)

The OSD shows large or small main speakers depending on how you set this item.

Choices: LARGE, SMALL

Initial setting: LARGE

LARGE

Select this if you have large main speakers. The entire range of the left and right main channel signal is directed to the left and right main speakers.



SMALL

Select this if you have small main speakers. The low-frequency signals (90 Hz and below) of the main channel are directed to the speakers selected with "1E LFE/BASS OUT".



Note

- When you select MAIN for "1E LFE/BASS OUT", the low-frequency signals (90 Hz and below) of the main channel are directed to the main speakers even if you select SMALL for the main speaker mode.

■ 1C REAR L/R SP (rear speaker mode)

The OSD shows large, small or no rear speakers depending on how you set this item.

Choices: LRG (large), SML (small), NONE

Initial setting: LRG

LRG

Select this if you have large left and right rear speakers or if a rear subwoofer is connected to the rear speakers. The entire range of the rear channel signal is directed to the left and right rear speakers.



SML

Select this if you have small left and right rear speakers. The low-frequency signals (90 Hz and below) of the rear channel are directed to the speakers selected with "1E LFE/BASS OUT".



NONE

Select this if you do not have rear speakers.



- This unit is set in the virtual CINEMA DSP mode by selecting NONE for "1C REAR L/R SP".

■ 1D REAR CT SP (rear center speaker mode)

By adding a rear center speaker to your speaker configuration, this unit can provide more realistic front-to-back and transitions.

Choices: LRG (large), SML (small), NONE

Initial setting: LRG

LRG

Select this if you have a large rear center speaker. The entire range of the rear center channel signal is directed to the rear center speaker.



SML

Select this if you have a small rear center speaker. The low-frequency signals (90 Hz and below) of the rear center channel are directed to the speakers selected with "1E LFE/BASS OUT".



NONE

Select this if you do not have a rear center speaker. All of the rear center channel signal are directed to the left and right rear speakers.



■ 1E LFE/BASS OUT (bass out mode)

LFE signals carry low-frequency effects when this unit decodes a Dolby Digital or DTS signal. Low-frequency signals are defined as 90 Hz and below. The Low-frequency signals are directed to both main right and left speakers, and the subwoofer (subwoofer can be used for both stereo reproduction and the DSP program).

Choices: SWFR (subwoofer), MAIN, BOTH

Initial setting: BOTH

SWFR

Select this if you use a subwoofer. The LFE signals are directed to the subwoofer.

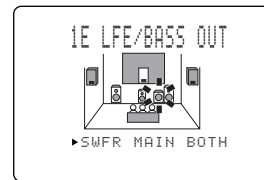

MAIN

Select this if you do not use a subwoofer. The LFE signals are directed to the main speakers.

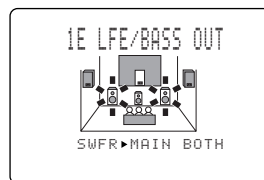

BOTH

Select this if you use a subwoofer and you want to mix the main channel low-frequency signals with the LFE signals.

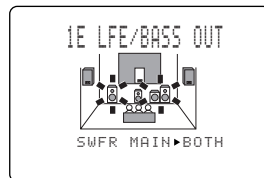

Note

- The low-frequency signals (90 Hz and below) from all main, center, rear and rear center channels are directed to the LFE channel when you select the small speaker setting in items 1A, 1B, 1C and 1D.

■ 1F MAIN LEVEL (main level mode)

Change this setting if you cannot match the output level of the center, rear (L/R) and rear center speakers with the main speakers because of the unusually high-efficiency performance of the main speakers.

Choices: Normal, -10 dB

Initial setting: Normal

Normal

Select this if you can match the output level of your effect speakers with that of your main speakers when using the test tone.



-10 dB

Select this if you cannot match the output level of your effect speakers with that of your main speakers when using the test tone.



2 LOW FRQ TEST

Use this feature to adjust the output level of the subwoofer so it matches that of the other speakers in your configuration. Change the setting with the remote control while sitting in the listening position.

- 1 Press **-/+** to set "TEST TONE" to ON, and adjust the volume with **VOLUME +/-** so you can hear the tone.

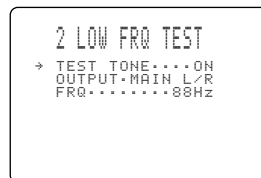

Notes

- Do not turn up the volume too high.
- If no test tone is heard, turn down the volume, set this unit in the standby mode and make sure all the necessary connections are correct.

- 2 Press **∇** to go to "OUTPUT" and press **-/+** to select the speaker you want to compare with the subwoofer.

If SWFR is selected, the test tone above 90 Hz will not be output from the subwoofer. The test tone will not necessarily be output from the selected speakers. The output mode of the test tone depends on the settings of "1 SPEAKER SET" on the SET MENU.

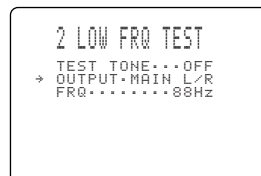

- 3 Press **∇** to go to "FRQ" and press **-/+** to select the frequency you want to use.

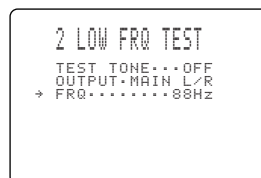

- 4 Adjust the volume of the subwoofer with the controls on the subwoofer so it matches that of the speaker you are comparing it to.**

About the test tone

The test tone is produced by the tone generator. The tone generator produces a narrow-band noise centered on a specified frequency by the band pass filter. You can change this center frequency from 35 Hz through 250 Hz in one-sixth octave steps.

You can use the test tone not only for adjusting the subwoofer level, but also for checking the low-frequency characteristics of your listening room. Low-frequency sounds are especially affected by the listener's position, speaker placement, subwoofer polarity and other conditions.

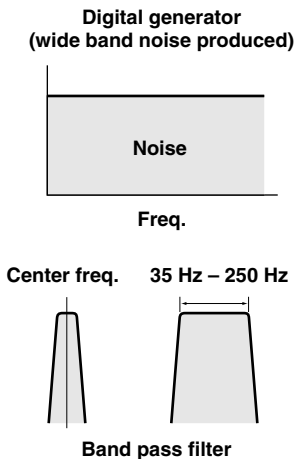

3 L/R BALANCE (balance of the left and right main speakers)

Use this feature to adjust the balance of the output level from the left and right main speakers.

Control range: 10 steps for L/R
Initial setting: 0 dB for L/R

Press + to decrease the output level for the left main speaker. Press – for the right main speaker.



4 HP TONE CTRL (headphone tone control)

Use this feature to adjust the level of the bass and treble when you use your headphones.

Control range (dB): –6 to +3 for both BASS and TRBL (treble)

Initial setting: 0 dB for both BASS and TRBL (treble)

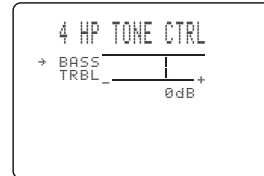

5 CENTER GEQ (center graphic equalizer)

Use this feature to adjust the built-in 5-band graphic equalizer so that the center speaker tonal quality matches that of the left and right main speakers. You can select the 100 Hz, 300 Hz, 1 kHz, 3 kHz, or 10 kHz frequencies.

Control range (dB): –6 to +6
Initial setting: 0 dB for 5-band

- 1 Press ∇ to select a higher frequency and ▲ to select a lower frequency.**

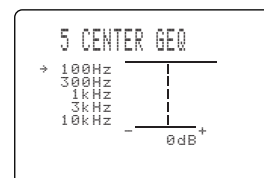

- 2 Press –/+ to adjust the level of that frequency.**

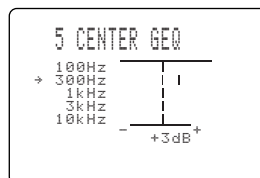

- You can monitor the center speaker sound while adjusting this item by using the test tone. Press TEST before starting the foregoing procedure. “TEST DOLBY SUR.” appears on the video monitor, and the test tone starts alternating among the speakers. Once you begin this procedure, the test tone remains at the center speaker and you can hear how the sound changes as you adjust the various frequency levels. To stop the test tone, press TEST (see pages 22 and 23).

6 INPUT RENAME

Use this feature to change the name of the input which appears on the OSD or the front panel display.

- 1 Press an input selector button (or use INPUT </>) to select the input you want to change the name of.

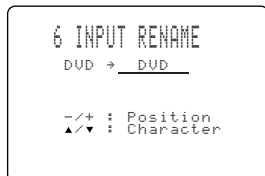

- 2 Press -/+ to place the _ (under-bar) under the space or the character you want to edit.

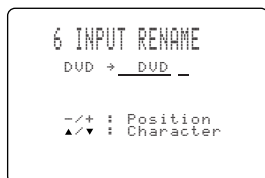

- 3 Press ▲ / ▼ to select the character you want to use and -/+ to move to the next one.

- Press ▼ to change the character in the following order, or press ▲ to go in the reverse order. A to Z, a space, 0 to 9, a space, a to z, a space, #, *, +, and so on.
- Follow the foregoing procedure to rename other inputs.

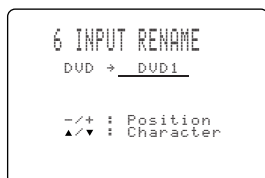

Note

- You can use up to 8 characters to rename the inputs.

- 4 Press + repeatedly to exit from INPUT RENAME.

7 I/O ASSIGNMENT

It is possible to assign jacks according to the component to be used if this unit's COMPONENT VIDEO input jack or DIGITAL INPUT/OUTPUT jack settings (component names for jacks) differ from that component. This makes it possible to change the jack assignment and effectively connect more component.

Once you assign, you can select that component with INPUT </> (the input selector buttons on the remote control).

7A CMPNT-V INPUT for COMPONENT VIDEO INPUT jacks [A] and [B]

- Choices:
- [A] DVD, V-AUX, VCR 2/DVR, VCR 1, CBL/SAT, D-TV/LD
 - [B] D-TV/LD, DVD, V-AUX, VCR 2/DVR, VCR 1, CBL/SAT

Initial settings: [A] DVD

[B] D-TV/LD

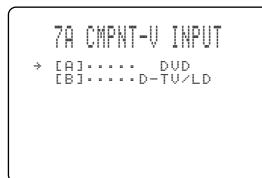

7B OPTICAL OUT for OPTICAL OUTPUT jacks (1) and (2)

- Choices:
- (1) MD/TAPE, CD-R, CD, PHONO, V-AUX, VCR 2/DVR, VCR 1, CBL/SAT, D-TV/LD, DVD, TUNER
 - (2) CD-R, CD, PHONO, V-AUX, VCR 2/DVR, VCR 1, CBL/SAT, D-TV/LD, DVD, MD/TAPE, TUNER

Initial settings: (1) MD/TAPE

(2) CD-R

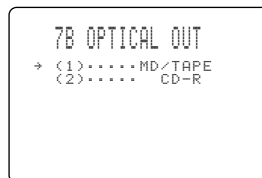

■ 7C OPTICAL IN for OPTICAL INPUT jacks (3) to (6)

- Choices:
- (3) CD, PHONO, VCR 2/DVR, VCR 1, CBL/SAT, D-TV/LD, DVD, MD/TAPE, CD-R, TUNER
 - (4) CD-R, CD, PHONO, VCR 2/DVR, VCR 1, CBL/SAT, D-TV/LD, DVD, MD/TAPE, TUNER
 - (5) DVD, MD/TAPE, CD-R, CD, PHONO, VCR 2/DVR, VCR 1, CBL/SAT, D-TV/LD, TUNER
 - (6) D-TV/LD, DVD, MD/TAPE, CD-R, CD, PHONO, VCR 2/DVR, VCR 1, CBL/SAT, TUNER

- Initial settings:
- (3) CD
 - (4) CD-R
 - (5) DVD
 - (6) D-TV/LD

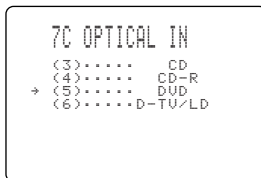

■ 7D COAXIAL IN for COAXIAL INPUT jacks (7) and (8)

- Choices:
- (7) CD, PHONO, V-AUX, VCR 2/DVR, VCR 1, CBL/SAT, D-TV/LD, DVD, MD/TAPE, CD-R, TUNER
 - (8) CBL/SAT, D-TV/LD, DVD, MD/TAPE, CD-R, CD, PHONO, V-AUX, VCR 2/DVR, VCR 1, TUNER

- Initial settings:
- (7) CD
 - (8) CBL/SAT

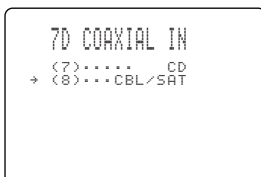

Note

- You cannot select an item more than once for the same type of jack.

8 INPUT MODE (initial input mode)

Use this feature to designate the input mode for sources connected to the DIGITAL INPUT jacks when you turn on this unit (see page 26 for details about the input mode).



- Choices: AUTO, LAST
Initial setting: AUTO

AUTO

Select this to allow this unit to automatically detect the type of input signal and select the appropriate input mode.

LAST

Select this to set this unit to automatically select the last input mode used for that source.

9 PARAM. INI (parameter initialization)

Use this feature to initialize the parameters for each DSP program within a DSP program group. When you initialize a DSP program group, all of the parameter values within that group revert to their initial settings.

Press the corresponding numeric button for the DSP program that you want to initialize.

The asterisk (*) next to the program number means that the parameter values have been changed.

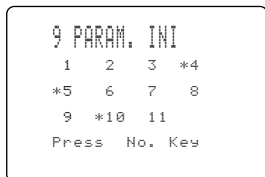

Notes

- You cannot initialize the individual DSP programs within a group separately.
- The parameter values of the DSP programs do not change if you initialize a program group that does not have the asterisk mark (*).
- When "14 MEMORY GUARD" is set to ON (see page 60), you cannot initialize any program groups.
- Once you initialize a DSP program group, you cannot automatically revert to the previous parameter settings.

10 LFE LEVEL

This setting is effective only when this unit decodes Dolby Digital or DTS signals.

Use this feature to adjust the output level of the LFE (low-frequency effect) channel when playing back a Dolby Digital or DTS signal. The LFE signal carries the low-frequency special effect sound which is only added to certain scenes.

Control range (dB): -20 to 0 for both SPEAKER and HEADPHONE

Initial setting: 0 dB for both SPEAKER and HEADPHONE

1 Press Δ / ∇ to select the item to be adjusted.

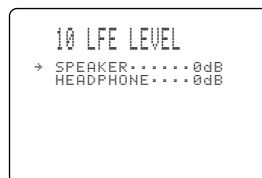

2 Press $-/+$ to adjust the LFE level.

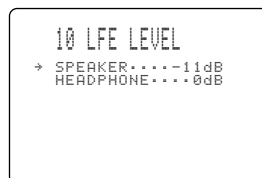

Note

- Adjust the LFE level according to the capacity of your subwoofer or headphones.

11 D-RANGE (dynamic range)

Use this feature to adjust the dynamic range. This setting is effective only when this unit decodes Dolby Digital signals.



MAX

Select the "MAX" setting for feature films.

STD

Select the "STD" (Standard) setting for general use.

MIN

Select the "MIN" setting for listening to sources at extremely low volume levels.

12 SP DELAY TIME

Use this feature to adjust the delay of the Center and the Rear Center channel sounds. This feature works when this unit decodes DTS or Dolby Digital signals. Ideally, the Center speaker and the Rear Center speaker should be the same distance from the main listening position as the left and right Main speakers. However, in most home situations, the Center speaker or the Rear Center speaker is placed in line with the Main speakers or the Rear speakers. By delaying the sound from the Center speaker and the Rear Center speaker, the apparent distance from the main listening position can be adjusted to make it seem the same as the distance between the left and right Main speaker, and the left and right Rear speakers to the listening position. Adjusting the delay time for the Center speaker is especially important for giving depth to the dialogue.

Control range: 0 to 5 ms for CENTER

0 to 30 ms for REAR CENTER

Initial setting: 0 ms for CENTER

3 ms for REAR CENTER

Press \pm to increase or decrease the delay of the center and the rear center channel sounds.



Center speaker image

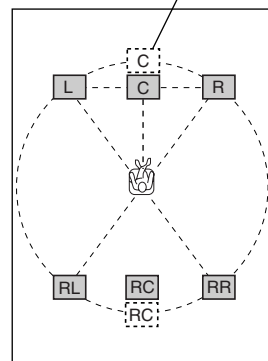

- Increasing the delay by 1 ms simulates moving the speakers about 30 cm (one foot) farther away from the listening position.

13 DISPLAY SET

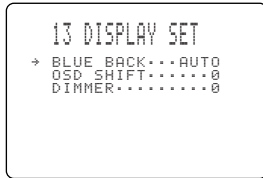

■ BLUE BACK

Selecting AUTO for the on-screen display setting displays a blue background when there's no video signal input. Nothing is displayed on the screen including the on-screen display if OFF is selected.

Choices: AUTO, OFF

Initial setting: AUTO

■ OSD SHIFT (OSD off-set position)

This setting is used to adjust the vertical position of the OSD.

Control range: +5 (downward) to -5 (upward)

Initial setting: 0

Press + to lower the position of the OSD.
Press - to raise the position of the OSD.

■ DIMMER

You can adjust the brightness of the front panel display.

Control range: -4 to 0

Initial setting: 0

14 MEMORY GUARD

Use this feature to prevent accidental changes to DSP program parameter values and other settings on this unit.

Choices: ON, OFF

Initial setting: OFF



Select ON to protect the following features:

- DSP program parameters
- All SET MENU items
- Center, rear speakers, rear center, and subwoofer levels
- The on-screen display (OSD) mode

Notes

- When "14 MEMORY GUARD" is set to ON, you cannot use the test tone.
- When "14 MEMORY GUARD" is set to ON, you cannot select any other SET MENU items.

ADJUSTING THE LEVEL OF THE EFFECT SPEAKERS

You can adjust the output level of each effect speaker (center, left and right rear, rear center and subwoofer) while listening to a music source.

Adjustment should be made with the remote control.

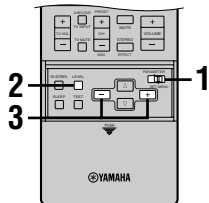

1 Set PARAMETER/SET MENU to PARAMETER.



2 Press LEVEL repeatedly to select the speaker(s) you want to adjust.

Each time you press LEVEL, the selected speaker changes and appears on the front panel display as follows: center, right rear, rear center, left rear and subwoofer.

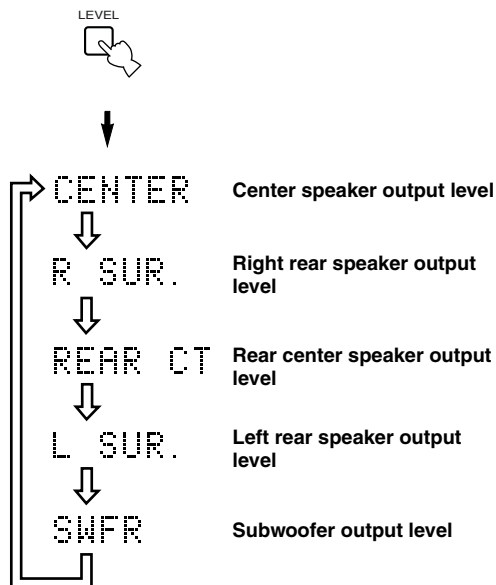

- Once you press LEVEL, you can also select the speaker(s) to be adjusted by pressing ∇/Δ .



3 Press ∇/Δ to adjust the speaker output level.

- The control range for the center, left and right rear or rear center speakers is from +10 dB to -10 dB.
- The control range for the subwoofer is from 0 dB to -20 dB.



- When PARAMETER/SET MENU is set to SET MENU, you cannot adjust the output level by using LEVEL. However, each time you press LEVEL, the current level of each speaker appears on the front panel display and you can check the speaker level.

Notes

- When the speaker output modes for "1A CENTER SP" and "1C REAR L/R SP" are set to NONE, and "1E LFE/BASS OUT" to MAIN, the output level of those speakers cannot be adjusted because there is no sound coming from these speakers.
- When you adjust the output level with LEVEL, the settings you made with the test tone will be changed.
- It is recommended to adjust the speakers (except for a subwoofer) by following the steps described in Using the Test Tone on pages 22 and 23.

Memory back-up

The memory back-up circuit prevents the stored data from being lost even if this unit is in the standby mode. However if the power cord is disconnected from the AC outlet, or the power supply is cut for more than one week, the stored data will be lost. If so, set the output level again.

SLEEP TIMER

Use this feature to automatically set this unit in the standby mode after the amount of time you have set. The sleep timer is useful when you are going to sleep while this unit is playing or recording a source. The sleep timer also automatically turns off the external components connected to AC OUTLETS.

The sleep timer can only be set with the remote control.



- By connecting a commercially available timer to this unit, you can also set a wake-up timer. Refer to the operation instructions for the timer.

Setting the Sleep Timer

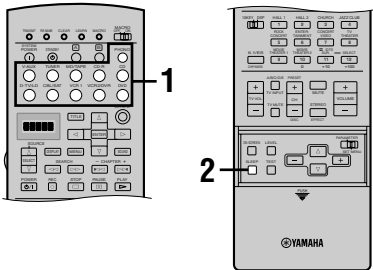

- 1 Select a source and start playback on the source component.

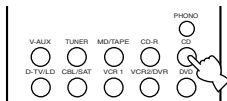

- 2 Press SLEEP repeatedly to set the amount of time before this unit automatically turns off.



Each time you press SLEEP, the front panel display changes as shown below.

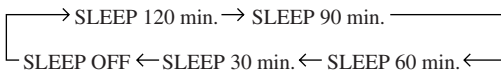

- 3 The "SLEEP" indicator soon lights up on the front panel display after the sleep timer has been set.

The display then returns to the previous indication.



Canceling the Sleep Timer

Press SLEEP repeatedly until "SLEEP OFF" appears on the front panel display.

After a few seconds, "SLEEP OFF" disappears, the "SLEEP" indicator goes off and the display returns to the previous indication.



SLEEP OFF



- The sleep timer setting can also be canceled by setting this unit in the standby mode by using STANDBY on the remote control (or STANDBY/ON on the front panel) or by disconnecting the AC power cord from the AC outlet.

SOUND FIELD PROGRAM PARAMETER EDITING

What is a sound field?

What really creates the rich, full tones of a live instrument are the multiple reflections from the walls of the room. In addition to making the sound “live”, these reflections enable us to tell where the player is situated, and the size and shape of the room in which we are sitting.

■ Elements of a sound field

In any environment, in addition to the direct sound coming straight to our ears from the player’s instrument, there are two distinct types of sound reflections that combine to make up the sound field:

Early reflections

Reflected sounds reach our ears extremely rapidly (50 ms – 100 ms after the direct sound), after reflecting from one surface only — for example, from the ceiling or a wall. These reflections fall into specific patterns as shown in the diagram on page 65 for any particular environment, and provide vital information to our ears. Early reflections actually add clarity to the direct sound.

Reverberations

These are caused by reflections from more than one surface — walls, ceiling, the back of the room — so numerous that they merge together to form a continuous sonic “afterglow”. They are non-directional, and lessen the clarity of the direct sound.

Direct sound, early reflections and subsequent reverberation taken together help us to determine the subjective size and shape of the room, and it is this information that the digital sound field processor reproduces in order to create sound fields.

If you could create the appropriate early reflections and subsequent reverberations in your listening room, you would be able to create your own listening environment. The acoustics in your room could be changed to those of a concert hall, a dance floor, or virtually any size room at all. This ability to create sound fields at will is exactly what YAMAHA has done with the digital sound field processor.

Sound Field Program Parameters

DSP programs consist of some parameters to determine the apparent room size, reverberation time, distance from you to the performer, etc. In each program, these parameters are set with values precisely calculated by YAMAHA to create a sound field unique to the program. It is recommended to use DSP programs without changing the values of parameters; however, this unit also allows you to create your own sound fields. Starting with one of the built-in programs, you can adjust those parameters.

Each DSP program has a set of parameters that allow you to change the characteristics of the acoustic environment to precisely create the effect you want. These parameters correspond to the many natural acoustic factors that create the sound field you experience in an actual concert hall or other listening environment. The size of the room, for example, affects the length of time between the early reflections. The “ROOM SIZE” parameter provided in many of the DSP programs alters the timing between these reflections, thus changing the shape of the “room” you are listening. In addition to room size, the shape of the room and the characteristics of its surfaces have a significant effect on the final sound. Surfaces that absorb sound, for example, cause the reflections and reverberations to die out more quickly, while highly reflective surfaces allow the reflections to carry on for a longer period of time. The digital sound field parameters allow you to control these and many other factors that contribute to your personal sound field, allowing you to essentially “redesign” the concert halls, theaters, etc. provided to create custom-tailored listening environments that ideally match your mood and music.

See “Digital Sound Field Parameter Descriptions” on pages 65 to 68.

Changing Parameter Settings

You can enjoy good quality sound with the factory-set parameters. Although you do not have to change the initial settings, you can change some of the parameters to better suit the input source or your listening room.

Adjustments should be made with the remote control.



- We recommended that you edit the parameter while using a video monitor. It is easier to see the video monitor than it is to see the front panel display.

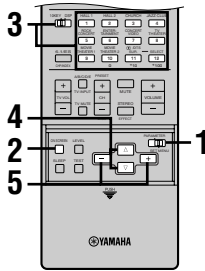

- 1** Set **PARAMETER/SET MENU** to **PARAMETER**.



- 2** Turn on the video monitor and press **ON SCREEN** repeatedly to select the full display mode.



- 3** Select a DSP program you want to adjust.

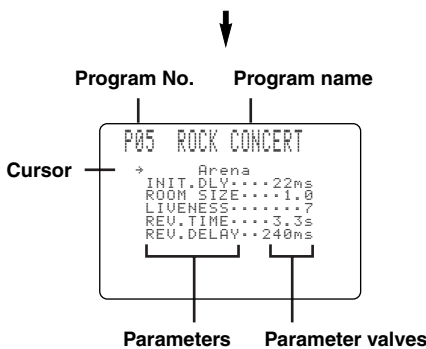
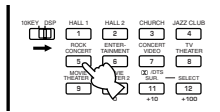

Example of the parameter setting display

- 4** Press Δ / ∇ to select the parameter.

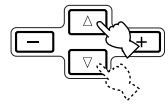

- 5** Press **-/+** to change the parameter value.

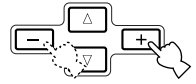

- When you set the parameter to a value other than the factory-set value, an asterisk mark (*) appears by the parameter name on the video monitor.

- 6** Repeat steps 3 to 5 above as necessary to change other program parameters.

Memory back-up

The memory back-up circuit prevents the stored data from being lost even if this unit is set in the standby mode, the power cord is disconnected from the AC outlet, or the power supply is temporarily cut due to power failure. However, if the power is cut for more than one week, the parameter value you edited will return to the factory setting. If so, edit the parameter value again.

Resetting a Parameter to the Factory-set Value

- **To reset some of the parameters to the factory-set values**

Select the parameter you want to reset. Then press and hold **-/+** until the value temporarily stops at the factory-set value. The asterisk mark (*) by the parameter name disappears on the video monitor.

- **To reset all of the parameters to the factory-set values**

Use "9 PARAM. INI" on the SET MENU to reset all of the parameter values of all DSP programs within the selected group to the factory-set values (see page 58). This operation resets all of the parameter values of all DSP programs within that group to the factory-set values.

Notes

- The available parameters may be displayed on more than one OSD page for some of the programs. To scroll through pages, press Δ / ∇ .
- You cannot change parameter values when "14 MEMORY GUARD" on the SET MENU is set to ON. If you want to change the parameter values, set "14 MEMORY GUARD" to OFF (see page 60).

DIGITAL SOUND FIELD PARAMETER DESCRIPTIONS

You can adjust the values of certain digital sound field parameters so the sound fields are recreated accurately in your listening room. Not all of the following parameters are found in every program.

■ INIT. DLY (Initial Delay)

[P. INT. DLY for the presence sound field]

Control Range 1 – 99 msec

Function: This parameter changes the apparent distance from the source sound by adjusting the delay between the direct sound and the first reflection heard by the listener.

Description: The smaller the value, the closer the sound source seems to the listener. The larger the value, the farther the apparent distance seems. For a small room, this parameter would be set to a small value, and for a large room, it would be set to a large value.

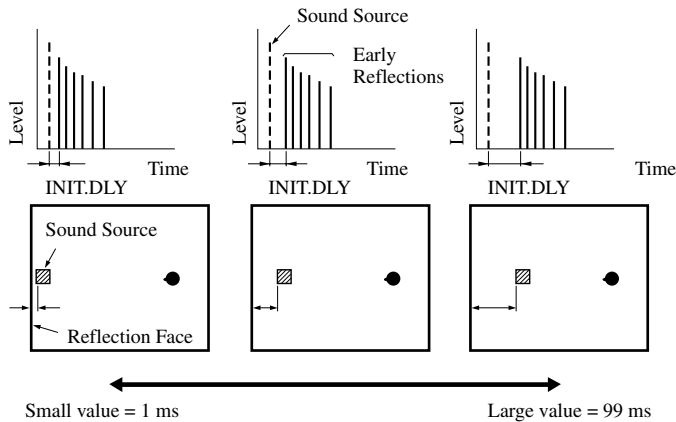

■ ROOM SIZE

[P. ROOM SIZE for the presence sound field]

Control Range 0.1 – 2.0

Function: This parameter adjusts the apparent size of the surround sound field. The larger the value, the larger the surround sound field becomes.

Description: As the sound is repeatedly reflected around a room, the larger the hall is, the longer the time between the original reflected sound and the subsequent reflections. By controlling the time between the reflected sounds, you can change the apparent size of the virtual venue. Changing this parameter from one to two, doubles the apparent length of the room.

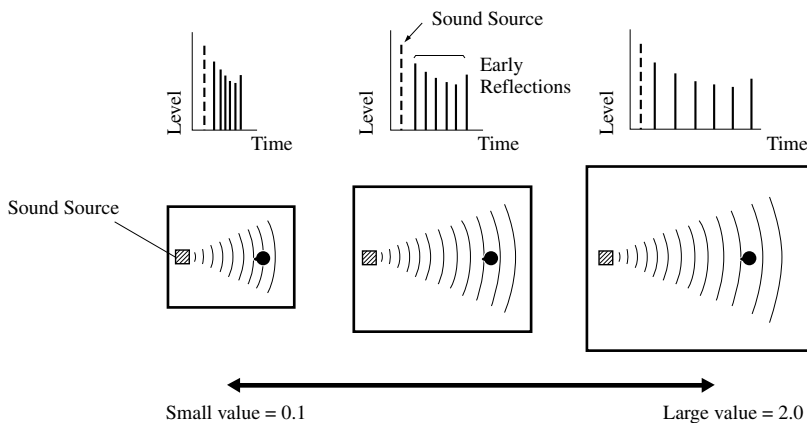

■ LIVENESS

Control Range 0 – 10

Function: This parameter adjusts the reflectivity of the virtual walls in the hall by changing the rate at which the early reflections decay.

Description: The early reflections of a sound source decay much faster in a room with acoustically absorbent wall surfaces than in one which has highly reflective surfaces. A room with acoustically absorbent surfaces is referred to as “dead”, while a room with highly reflective surfaces is referred to as “live”. The LIVENESS parameter lets you adjust the early reflection decay rate, and thus the “liveness” of the room.

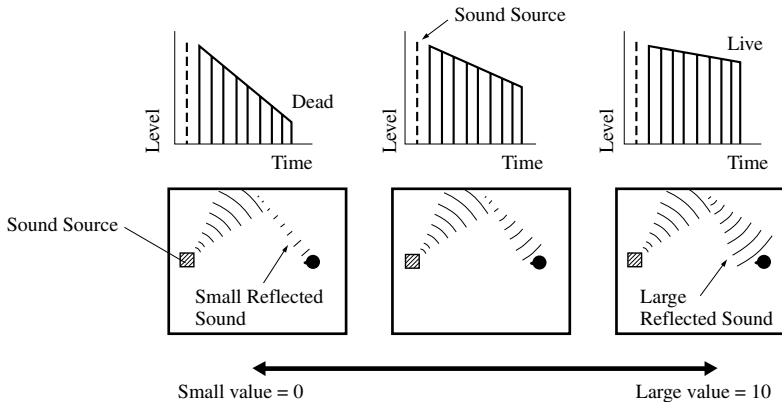

■ S. DELAY (Surround Delay)

Control Range 0 – 49 msec (The range depends on the signal format.)

Function: This parameter adjusts the delay between the direct sound and the surround sound.

■ S. INIT. DLY (Surround Initial Delay)

Control Range 1 – 49 msec

Function: This parameter adjusts the delay between the direct sound and the first reflection on the surround side of the sound field. You can only adjust this parameter when at least two front channels and two rear channels are used.

■ S. ROOM SIZE (Surround Room Size)

Control Range 0.1 – 2.0

Function: This parameter adjusts the apparent size of the surround sound field.

■ S. LIVENESS (Surround Liveness)

Control Range 0 – 10

Function: This parameter adjusts the apparent reflectivity of the virtual walls in the surround sound field.

■ RC INIT. DLY (Rear Center Initial Delay)

Control Range 1 – 49 msec

Function: This parameter adjusts the delay between the direct sound and the first reflection in the rear center sound field.

■ RC ROOM SIZE (Rear Center Room Size)

Control Range 0.1 – 2.0

Function: This parameter adjusts the apparent size of the rear center sound field.

■ RC LIVENESS (Rear Center Liveness)

Control Range 0 – 10

Function: This parameter adjusts the apparent reflectivity of the virtual wall in the rear center sound field.

■ REV. TIME (Reverberation Time)

Control Range 1.0 – 5.0 sec

Function: This parameter adjusts the amount of time it takes for the dense, subsequent reverberation sound to decay by 60 dB (at 1 kHz). This changes the apparent size of the acoustic environment over an extremely wide range.

Description: Set a longer reverberation time for “dead” sources and listening room environments, and a shorter time for “live” sources and listening room environments.

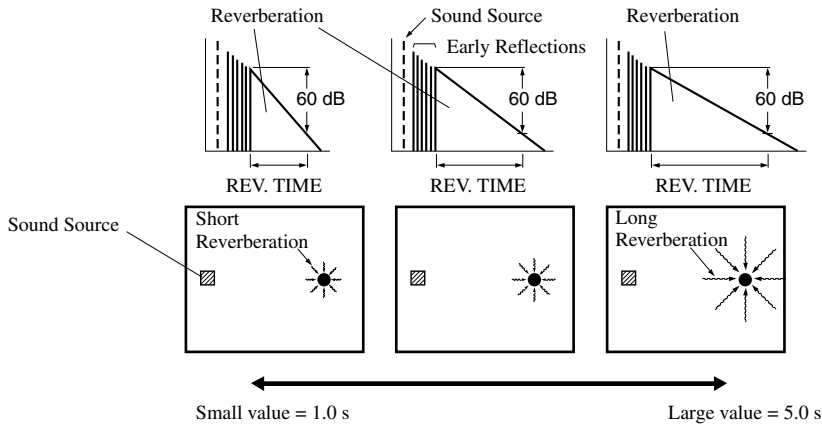

■ REV. DELAY (Reverberation Delay)

Control Range 0 – 250 msec

Function: This parameter adjusts the time difference between the beginning of the direct sound and the beginning of the reverberation sound.

Description: The larger the value, the later the reverberation sound begins. A later reverberation sound makes you feel like you are in a larger acoustic environment.

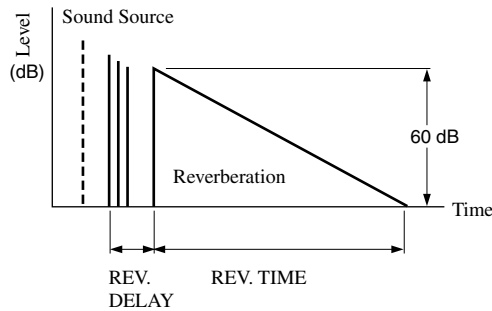

■ REV. LEVEL (Reverberation Level)

Control Range 0 – 100 %

Function: This parameter adjusts the volume of the reverberation sound.

Description: The larger the value, the stronger the reverberation becomes.

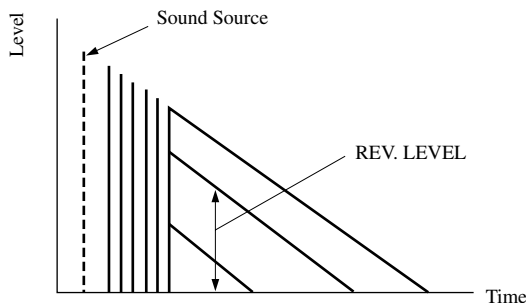

For 6ch Stereo**■ CT LEVEL (Center Level)****Control Range 0 – 100 %**

Function: These parameters adjust the volume level for each channel in 6-channel stereo mode.

■ RL LEVEL (Rear Left Level)**Control Range 0 – 100 %**

Function: These parameters adjust the volume level for each channel in 6-channel stereo mode.

■ RR LEVEL (Rear Right Level)**Control Range 0 – 100 %**

Function: These parameters adjust the volume level for each channel in 6-channel stereo mode.

■ RC LEVEL (Rear Center Level)**Control Range 0 – 100 %**

Function: These parameters adjust the volume level for each channel in 6-channel stereo mode.

For PRO LOGIC II Music**■ PANORAMA****Control Range OFF/ON**

Function: Extends the front stereo image to include the surround speakers for wraparound effect.

■ DIMENSION**Control Range -3 – STD – +3**

Function: Gradually adjusts the soundfield either towards the front or towards the rear.

■ CT WIDTH (Center Width)**Control Range 0 – 7**

Function: Adjusts the center image from all three front speakers to varying degrees.

TROUBLESHOOTING

Refer to the chart below when this unit does not function properly. If the problem you are experiencing is not listed below or if the instruction below does not help, set this unit in the standby mode, disconnect the power cord, and contact the nearest authorized YAMAHA dealer or service center.

■ General

Problem	Cause	Remedy	Refer to page
This unit fails to turn on when STANDBY/ ON (or SYSTEM POWER) is pressed, or enters in the standby mode soon after the power has been turned on.	The power cord is not connected or the plug is not completely inserted.	Firmly connect the power cord.	19
	The IMPEDANCE SELECTOR switch on the rear panel is not fully set to the upper or lower position.	Set the switch fully to the upper or lower position when this unit is in the standby mode.	13
	The protection circuitry has been activated.	Make sure all speaker wire connections on this unit and on all speakers are secure and that the wire for each connection does not touch anything other than its respective connection.	—
	This unit has been exposed to a strong external electric shock (such as lightning and strong static electricity)	Set this unit in the standby mode, disconnect the power cord, plug it back in after 30 seconds, and start operating.	19
On-screen display does not appear.	The setting for the on-screen display is set to “DISPLAY OFF”.	Select the full display or short display mode.	20
	The BLUE BACK setting under “13 DISPLAY SET” on the SET MENU is set to OFF, and no video signal is input to this unit.	Set BLUE BACK to AUTO to always show the OSD.	60
No sound and/or no picture.	Incorrect input or output cable connections.	Connect the cables properly. If the problem persists, the cables may be defective.	11, 12
	An appropriate input source has not been selected.	Select an appropriate input source with INPUT ◀ / ▶ or 6CH INPUT (or the input selector buttons).	24
	The speaker connections are not secure.	Secure the connections.	11, 12
	The main speakers to be used have not been selected properly.	Select the main speakers with SPEAKERS A and/or B.	24
	The volume is turned down.	Turn up the volume.	25
	The sound is muted.	Press MUTE or any operation buttons of this unit to cancel a mute and adjust the volume.	25
	Digital signals other than PCM audio, Dolby Digital or DTS signal which this unit cannot reproduce are being input to this unit by playing a CD-ROM, etc.	Play a source whose signals this unit can reproduce.	—
The picture does not appear.	The output and input for the picture are connected to different types of video jacks.	Make connections using the same type of jack (between S VIDEO, VIDEO (composite), or COMPONENT VIDEO jacks) for both the input and output.	14, 15

Problem	Cause	Remedy	Refer to page
The sound suddenly goes off.	The protection circuit has been activated because of a short circuit, etc.	Check the IMPEDANCE SELECTOR switch is set to the appropriate position and then turn this unit back on.	13
		Check the speaker wires are not touching each other and then turn this unit back on.	—
	The sleep timer has functioned.	Turn on the power, and play the source again.	62
	The sound is muted.	Press MUTE or any operation buttons of this unit to cancel a mute and adjust the volume.	25
Only the speaker on one side can be heard.	Incorrect cable connections.	Connect the cables properly. If the problem persists, the cables may be defective.	11, 12
	Incorrect setting of “3 L/R BALANCE” on the SET MENU.	Adjust it to the appropriate position.	55
No sound from the effect speakers.	The sound effect is off.	Press STEREO/EFFECT to turn it on.	29
	A Dolby Surround, Dolby Digital or DTS decoding DSP program is being used with material not encoded with Dolby Surround, Dolby Digital or DTS.	Select another DSP program.	30 – 35
	A 96-kHz sampling digital signal is being input to this unit.		26
No sound from the center speaker.	The output level of the center speaker is set to minimum.	Raise the level of the center speaker.	61
	“1A CENTER SP” on the SET MENU is set to NONE.	Select the appropriate mode for your center speaker.	51
	One of the Hi-Fi DSP programs (1 to 6 except for Game and 6ch Stereo) has been selected.	Select another DSP program.	30 – 35
	The source encoded with a Dolby Digital or DTS signal does not have a center channel signal.		—
No sound from the rear speakers.	The output level of the rear speakers is set to minimum.	Raise the output level of the rear speakers.	61
	A monaural source is being played with the program 11.	Select another DSP program.	30 – 35
No sound from the subwoofer.	“1E LFE/BASS OUT” on the SET MENU is set to MAIN when a Dolby Digital or DTS signal is being played.	Select SWFR or BOTH.	53
	“1E LFE/BASS OUT” on the SET MENU is set to SWFR or MAIN when a 2-channel source is being played.	Select BOTH.	53
	The source does not contain low bass signals (90 Hz and below).		—
Poor bass reproduction.	“1E LFE/BASS OUT” on the SET MENU is set to SWFR or BOTH and your system does not include a subwoofer.	Select MAIN.	53
	The output mode for each speaker (main, center, rear, or rear center) on the SET MENU does not match your speaker configuration.	Select the appropriate output mode for each speaker based on the size of the speakers in your configuration.	51 – 54

Problem	Cause	Remedy	Refer to page
No sound from the rear center speaker.	“1D REAR CT SP” on the SET MENU is set to NONE.	Select LRG or SML.	53
	6.1/ES is not on.	Press the 6.1/ES button on the remote control to turn it on.	28, 29
A “humming” sound can be heard.	Incorrect cable connections.	Firmly connect the audio plugs. If the problem persists, the cables may be defective.	17
	No connection from the turntable to the GND terminal.	Connect the grounding cord of your turntable to the GND terminal of this unit.	16, 17
The volume level is low while playing a record.	The record is being played on a turntable with an MC cartridge.	The turntable should be connected to this unit through an MC-head amplifier.	16, 17
The volume level cannot be increased, or the sound is distorted.	The component connected to the OUT (REC) jacks of this unit is turned off.	Turn on the power to the component.	16, 17
The sound effect cannot be recorded.	It is not possible to record the sound effect by a recording component.		—
A source cannot be recorded by a digital recording component connected to the DIGITAL OUTPUT jack of this unit.	A source component is only connected to the analog input jacks of this unit.	Connect the source component to the DIGITAL INPUT jacks of this unit.	14 – 17
The sound field parameters and some other settings on this unit cannot be changed.	“14 MEMORY GUARD” on the SET MENU is set to ON.	Select OFF.	60
This unit does not operate properly.	The internal microcomputer has been frozen by an external electric shock (such as lightning or excessive static electricity) or by a power supply with low voltage.	Disconnect the AC power cord from the outlet and then plug it in again after about 30 seconds.	—
“CHECK SP WIRES” appears on the front panel display.	Speaker cables are short circuited.	Make sure all speaker cables are connected correctly.	—
The sound is degraded when listening with headphones connected to a tape deck or CD player that is connected to this unit.	This unit is in the standby mode.	Turn on the power of this unit.	19
There is noise interference from digital or high-frequency equipment, or this unit.	This unit is too close to the digital or high-frequency equipment.	Move this unit further away from such equipment.	—
This unit suddenly turns into the standby mode.	The internal temperature becomes too high and the overheat protection circuitry has been activated.	Wait until this unit cools down and then turn it back on.	—

■ Remote control

Problem	Cause	Remedy	Refer to page
The remote control does not work nor function properly.	Wrong distance or angle.	The remote control will function within a maximum range of 6 m (20 feet) and no more than 30 degrees off-axis from the front panel.	7
	Direct sunlight or lighting (from an inverter type of fluorescent lamp, etc.) is striking the remote control sensor of this unit.	Reposition this unit.	—
	The batteries are weak.	Replace all batteries with new ones and press RESET.	3
	The manufacturer code has not been correctly set.	Set the manufacturer code correctly.	38
Try to set the other codes of the same manufacturer.		38	
The remote control does not “learn” new functions.	The batteries of this remote control and/or the other remote control are too weak.	Replace the batteries.	3
	The distance between the two remote controls is too much or too little.	Place the remote controls at the proper distance.	39
	The signal coding or modulation of the other remote control is not compatible with this remote control.	Learning is not possible.	—
	Memory capacity is full.	Further learning is not possible without deleting unnecessary functions.	43
	Even if the manufacturer code is correctly set, there are some models that do not respond to the remote control.	Program the necessary functions independently into the programmable buttons on this unit’s remote control using the Learn feature.	39
Continuous functions such as volume adjustment are learned, but operate only for a moment before stopping.	The learning process is incomplete.	Be sure to press and hold the function button on the other remote control until “OK” appears in the display window.	39

GLOSSARY

■ Dolby Surround

Dolby Surround uses a four analog channel recording system to reproduce realistic and dynamic sound effects: two left and right main channels (stereo), a center channel for dialog (monaural), and a rear channel for special sound effects (monaural). The rear channel reproduces sound within a narrow frequency range.

Dolby Surround is widely used with nearly all video tapes and laser discs, and in many TV and cable broadcasts as well. The Dolby Pro Logic decoder built into this unit employs a digital signal processing system that automatically stabilizes the volume on each channel to enhance moving sound effects and directionality.

■ Dolby Digital

Dolby Digital is a digital surround sound system that gives you completely independent multi-channel audio. With three front channels (left, center and right), and two rear stereo channels, Dolby Digital provides five full-range audio channels. With an additional channel especially for bass effects, called LFE (low frequency effect), the system has a total of 5.1 channels (LFE is counted as 0.1 channel).

Using two-channel stereo for the rear speakers, more accurate moving sound effects and surround sound environment are possible than with Dolby Surround. The wide dynamic range (from maximum to minimum volume) reproduced by the five full-range channels and the precise sound orientation generated using digital sound processing provide listeners with previously unheard of excitement and realism.

With this unit, any sound environment from monaural up to a 5.1-channel configuration can be freely selected for your enjoyment.

■ Dolby Pro Logic II

Dolby Pro Logic II is the improved technique to decode vast numbers of existing Dolby Surround programs. This new technology enables a discrete 5-channel playback with two left and right main channels, a center channel, and two left and right rear channels compared with one limited rear channel for the conventional Pro Logic technology. Also the music mode is available for 2-channel sources in addition to the movie mode.

■ DTS (Digital Theater Systems) Digital Surround

DTS digital surround was developed to replace the analog soundtracks of movies with a six-channel digital sound track, and is now rapidly gaining popularity in movie theaters around the world. Digital Theater Systems Inc. has developed a home theater system so that you can enjoy the depth of sound and natural spatial representation of DTS digital surround in your home. This system is practically distortion-free, clear 6-channel sound (technically, a left, right and center channels, two rear channels, plus an LFE 0.1 channel as a subwoofer, for a total of 5.1 channels).

■ DTS Neo: 6

Neo: 6 decodes the conventional 2-channel sources for 6 channel playback by the specific decoder. It enables playback with the full-range channels with higher separation just like digital discrete signal playback. Two modes are available; "Music mode" for playing music sources and "Cinema mode" for movies.

■ LFE 0.1 channel

This channel is for the reproduction of low bass signals. The frequency range for this channel is 20 Hz to 120 Hz. This channel is counted as 0.1 because it only enforces a low frequency range compared to the full-range reproduced by the other 5 channels in a Dolby Digital or DTS 5.1 channel systems.

■ CINEMA DSP

Since the Dolby Surround and DTS systems were originally designed for use in movie theaters, their effect is best felt in a theater having many speakers and designed for acoustic effects. Since home conditions, such as room size, wall material, number of speakers, and so on, can differ so widely, it's inevitable that there are differences in the sound heard as well. Based on a wealth of actually measured data, YAMAHA CINEMA DSP uses YAMAHA original sound field technology to combine Dolby Pro Logic, Dolby Digital and DTS systems to provide the visual and audio experience of movie theater in the listening room of your own home.

■ SILENT CINEMA DSP

YAMAHA has developed a natural, realistic sound effect DSP algorithm for headphones. Parameters for headphones have been set for each sound field so that accurate representations of all the sound field programs can be enjoyed on headphones.

■ Virtual CINEMA DSP

YAMAHA has developed a virtual CINEMA DSP algorithm that allows you to enjoy DSP sound field surround effects even without any rear speakers by using virtual rear speakers.

It is even possible to enjoy virtual CINEMA DSP in a minimum two-speaker system that does not include a center speaker.

■ S VIDEO signal

With S VIDEO signal system, the video signal normally transmitted using a pin cable is separated and transmitted as the Y signal for the luminance and the C signal for the chrominance through the S VIDEO cable. Using the S VIDEO jack eliminates video signal transmission loss and allows recording and playback of even more beautiful images.

■ Component video signal

With the component video signal system, the video signal is separated into the Y signal for the luminance and the P_B/C_B and P_R/C_R signals for the chrominance. Color can be reproduced more faithfully with this system because each of these signals is independent. The component signal is also called the “color difference signal” because the luminance signal is subtracted from the color signal. A monitor with component input jacks is required in order to use the component signal for output.

■ PCM (Linear PCM)

Linear PCM is a signal format under which an analog audio signal is digitized, recorded and transmitted without using any compression. This is used as a method of recording CDs and DVD audio. The PCM system uses a technique for sampling the size of the analog signal per very small unit of time. Standing for “pulse code modulation”, the analog signal is encoded as pulses and then modulated for recording.

■ Sampling frequency and number of quantized bits

When digitizing an analog audio signal, the number of times the signal is sampled per second is called the sampling frequency, while the degree of fineness when converting the sound level into a numeric value is called the number of quantized bits.

The range of rates that can be played back is determined based on the sampling rate, while the dynamic range representing the sound level difference is determined by the number of quantized bits. In principle, the higher the sampling frequency, the wider the range of frequencies that can be played back, and the higher the number of quantized bits, the more finely the sound level can be reproduced.

■ I/O assignment (SET MENU)

Although component is normally connected according to jack names shown on the rear panel, this unit includes a function that assigns jacks according to the component being connected. If the component being used differs from the component name shown for this unit’s component video input jacks or digital input/output jacks, it is possible to assign jacks according to the component being connected. This makes it possible to change the jack assignment and effectively connect more component.

SPECIFICATIONS

AUDIO SECTION

- Minimum RMS Output Power for Main, Center, Rear
20 Hz to 20 kHz, 0.02% THD, 8 Ω 120 W
- DIN Standard Output Power
1 kHz, 0.7% THD, 4 Ω 180 W
- Dynamic Power (IHF)
8/6/4/2 Ω 145/180/240/330 W
- Damping Factor
20 Hz to 20 kHz, 8 Ω 200 or more
- Frequency Response
CD to Main L/R 10 Hz to 100 kHz, -3 dB
- Total Harmonic Distortion
20 Hz to 20 kHz, 60 W, 8 Ω , Main L/R 0.008%
- Signal to Noise Ratio (IHF-A Network)
PHONO MM to Main L/R (5 mV, shorted) 81 dB
CD (250 mV, shorted) to Main L/R, Effect Off 100 dB
- Residual Noise (IHF-A Network)
Main L/R 150 μ V or less
- Channel Separation (1 kHz/10 kHz)
CD (5.1 k Ω terminated) to Main L/R 60 dB/45 dB
- Tone Control (Main L/R)
BASS Boost/Cut \pm 10 dB/50 Hz
TREBLE Boost/Cut \pm 10 dB/20 kHz
BASS EXTENSION +6 dB/60 Hz
- Phones Output 150 mV/100 Ω
- Input Sensitivity
CD, etc 150 mV/47 k Ω
PHONO 2.5 mV/47 k Ω
6CH INPUT 150 mV/40 - 47 k Ω
- Output Level
REC OUT 150 mV/0.9 k Ω
PRE OUT 1.0 V/1.2 k Ω
SUBWOOFER 4.0 V/1.2 k Ω

VIDEO SECTION

- Video Signal Type PAL
- Composite Video Signal Level 1 Vp-p/75 Ω
- S-Video Signal Level
Y 1 Vp-p/75 Ω
C 0.286 Vp-p/75 Ω
- Component Video Signal Level
Y 1 Vp-p/75 Ω
P_B/C_B, P_R/C_R 0.7 Vp-p/75 Ω
- Signal to Noise Ratio 50 dB
- Frequency Response (MONITOR OUT)
Composite, S-Video 5 Hz to 10 MHz, -3 dB
Component DC to 60 MHz, -3 dB

GENERAL

- Power Supply AC 230V/50 Hz
- Power Consumption 500 W
Standby Mode approx. 1.2 W
- AC Outlets (Total 100 W maximum)
[Europe model] 3 (SWITCHED)
[U.K. model] 1 (SWITCHED)
- Dimension (W x H x D) 435 x 191 x 468 mm
- Weight 21 kg
- Accessories Remote control
Batteries
Connection guide
Power cord [Europe model only]

* Specifications are subject to change without notice.



YAMAHA ELECTRONICS CORPORATION, USA 6660 ORANGETHORPE AVE., BUENA PARK, CALIF. 90620, U.S.A.
YAMAHA CANADA MUSIC LTD. 135 MILNER AVE., SCARBOROUGH, ONTARIO M1S 3R1, CANADA
YAMAHA ELECTRONIK EUROPA G.m.b.H. SIEMENSSTR. 22-34, 25462 RELINGEN BEI HAMBURG, F.R. OF GERMANY
YAMAHA ELECTRONIQUE FRANCE S.A. RUE AMBROISE CROIZAT BP70 CROISSY-BEAUBOURG 77312 MARNE-LA-VALLÉE CEDEX02, FRANCE
YAMAHA ELECTRONICS (UK) LTD. YAMAHA HOUSE, 200 RICKMANSWORTH ROAD WATFORD, HERTS WD1 7JS, ENGLAND
YAMAHA SCANDINAVIA A.B. J A WETTERGRENS GATA 1, BOX 30053, 400 43 VÄSTRA FRÖLUNDA, SWEDEN
YAMAHA MUSIC AUSTRALIA PTY, LTD. 17-33 MARKET ST., SOUTH MELBOURNE, 3205 VIC., AUSTRALIA

YAMAHA CORPORATION
Printed in Japan **UP** VIDEO V893090