



AX-496/396

STEREO AMPLIFIER

AMPLIFICATEUR STEREO

**OWNER'S MANUAL
MODE D'EMPLOI
BEDIENUNGSANLEITUNG
BRUKSANVISNING
MANUALE DI ISTRUZIONI
MANUAL DE INSTRUCCIONES
GEBRUIKSAANWIJZING**

**UNPACKING
DEBALLAGE
AUSPACKEN
UPPACKNING
DISIMBALLAGGIO
DESEMBALAJE
UITPAKKEN**

After unpacking, check that the following items are contained.

Après le déballage, vérifiez que les pièces suivantes sont incluses.

Nach dem Auspacken überprüfen, ob die folgenden Teile vorhanden sind.

Kontrollera efter det apparaten packats upp att följande delar finns med.

Verificare che tutte le parti seguenti siano contenute nell'imballaggio dell'apparecchio.

Desembale el aparato y verifique que los siguientes accesorios están en la caja.

Controleer na het uitpakken of de volgende onderdelen voorhanden zijn.

- Remote control
- Télécommande
- Fernbedienung
- Fjärrkontroll
- Telecomando
- Control remoto
- Afstandbediening



- Batteries (size AA, R6, UM-3)
- Piles (format AA, R6, UM-3)
- Batterien (Größe AA, R6, UM-3)
- Batterier (Storl. AA, R6, UM-3)
- Batterie (dimensioni AA, o R6, o UM-3)
- Pilas (tamaño AA, tipo R6, UM-3)
- Batterijen (maat AA, R6, UM-3)

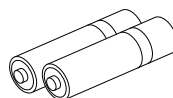

Opening and closing the front cover

Close the front cover whenever the controls inside the panel are not used.

Ouverture et fermeture du couvercle avant

Fermer le couvercle avant lorsque les commandes placées à l'intérieur du panneau ne sont pas utilisées.

Öffnen und Schließen der Reglerfachklappe

Schließen Sie die Reglerfachklappe, wenn Sie die Regler im Fach nicht verwenden.

Öppning och stängning av frontluckan

Ha frontluckan stängd när kontrollerna innanför den inte används.

Apertura e chiusura dello sportello anteriore

Richiudere sempre lo sportello anteriore quando i comandi non vengono utilizzati.

Apertura y cierre de la cubierta delantera

Cierre la cubierta delantera cuando no utilice los controles del panel.

Openen en sluiten van het voorklepje

Sluit het voorklepje steeds wanneer de bedieningsorganen binnen in het paneel niet gebruikt worden.

To open the front cover

Pour ouvrir le couvercle avant

Öffnen der Reglerfachklappe

Öppning av frontluckan

Apertura

Para abrir la cubierta delantera

Openen van het voorklepje

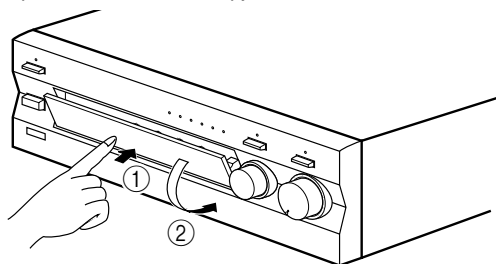

To close the front cover

Pour fermer le couvercle avant

Schließen der Reglerfachklappe

Stängning av frontluckan

Chiusura

Para cerrar la cubierta delantera

Sluiten van het voorklepje

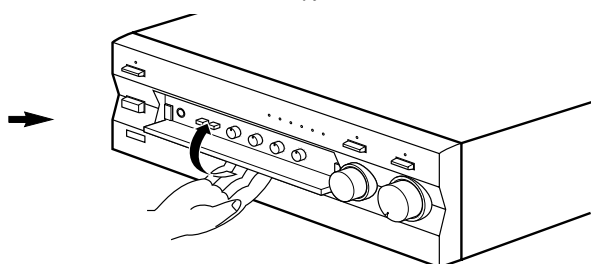

FEATURES

- **AX-496**
85W + 85W (8Ω) RMS Output Power, 0.019% THD, 20–20,000 Hz
- **AX-396**
60W + 60W (8Ω) RMS Output Power, 0.019% THD, 20–20,000 Hz
- Highly Dynamic Power, Low Impedance Drive Capability
- Continuously Variable LOUDNESS Control
- CD/DVD DIRECT AMP Switch Used to Reproduce the Purest CD and DVD Sound
- Remote Control Capability

AX-496 only

- REC OUT Selector Independent of Input Source Selection
- PURE DIRECT Switch Used to Reproduce the Purest Source Sound

CONTENTS

UNPACKING	Inside of Front Cover
FEATURES	1
CAUTION	2
NOTES ABOUT THE REMOTE CONTROL	3
CONNECTIONS	4
CONTROLS AND THEIR FUNCTIONS	6
OPERATION	9
TROUBLESHOOTING	13
SPECIFICATIONS	14

CAUTION: Read this before operating your unit.

1. To assure the finest performance, please read this manual carefully. Keep it in a safe place for future reference.
2. Install this unit in a cool, dry, clean place – away from windows, heat sources, sources of excessive vibration, dust, moisture and cold. Avoid sources of humming (transformers, motors). To prevent fire or electrical shock, do not expose the unit to rain or water.
3. Never open the cabinet. If something drops into the set, contact your dealer.
4. Do not use force on switches, controls or connection wires. When moving the unit, first disconnect the power plug and the wires connected to other equipments. Never pull the wires themselves.
5. The openings on the unit cover assure proper ventilation of the unit. If these openings are obstructed, the temperature inside the unit will rise rapidly; therefore, avoid placing objects against these openings. Install the unit in a well-ventilated area to prevent fire or damage.
Be sure to allow a space of at least 20 cm behind, 20 cm on both sides and 30 cm above the top panel of the unit to prevent fire or damage.
6. The voltage used must be the same as that specified on this unit. Using this unit with a higher voltage than specified is dangerous and may result in fire or other accidents. YAMAHA will not be held responsible for any damage resulting from use of this unit with a voltage other than specified.
7. Always set the VOLUME control to “∞” before starting the audio source play. Increase the volume gradually to an appropriate level after the play has been started.
8. Do not attempt to clean the unit with chemical solvents as this might damage the finish. Use a clean, dry cloth.
9. Be sure to read the “TROUBLESHOOTING” section regarding common operating errors before concluding that the unit is faulty.
10. When not planning to use this unit for a long period (ie., vacation, etc.), disconnect the AC power plug from the wall outlet.
11. To prevent lightning damage, disconnect the AC power plug when there is an electric storm.
12. Grounding or polarization – Precautions should be taken so that the grounding or polarization of an appliance is not defeated.
13. Do not connect any audio equipment to the AC outlet on the rear panel if the equipment requires more power than the outlet is rated to provide.

For U.K. customers

If the socket outlets in the home are not suitable for the plug supplied with this appliance, it should be cut off and an appropriate 3 pin plug fitted. For details, refer to the instructions described below.

Note: The plug severed from the mains lead must be destroyed, as a plug with bared flexible cord is hazardous if engaged in a live socket outlet.

SPECIAL INSTRUCTIONS FOR U.K. MODEL

IMPORTANT:

THE WIRES IN MAINS LEAD ARE COLOURED IN ACCORDANCE WITH THE FOLLOWING CODE:

Blue: NEUTRAL

Brown: LIVE

As the colours of the wires in the mains lead of this apparatus may not correspond with the coloured markings identifying the terminals in your plug, proceed as follows: The wire which is coloured BLUE must be connected to the terminal which is marked with the letter N or coloured BLACK. The wire which is coloured BROWN must be connected to the terminal which is marked with the letter L or coloured RED. Making sure that neither core is connected to the earth terminal of the three pin plug.

When this unit is turned off by pressing the STANDBY/ON switch on the front panel or the remote control, the STANDBY indicator on the front panel lights up. This state is called the standby mode. In this mode, this unit is designed to consume a small amount of power. This unit's power supply cannot be completely cut off from the AC line until the POWER switch on the front panel is set in the OFF position or the AC power cord is disconnected.

WARNING

Do not change the IMPEDANCE SELECTOR switch setting while the power to this unit is on, otherwise this unit may be damaged.

If this unit fails to turn on when the **POWER** switch is pressed:

The **IMPEDANCE SELECTOR** switch may not be set to either end. If so, set the switch to either end when this unit's power supply is completely cut off.

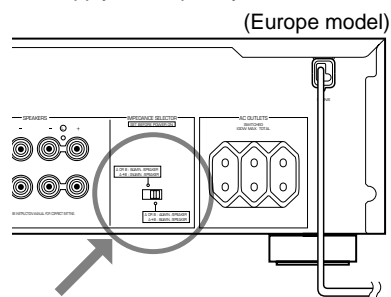

Battery installation

Since the remote control will be used for many of this unit's control operations, you should begin by installing the supplied batteries.

1. Turn the remote control over and remove the battery compartment cover by sliding it in the direction of the arrow.
2. Insert the batteries (AA, R6, UM-3 type) according to the polarity markings on the inside of the battery compartment.
3. Close the battery compartment cover.

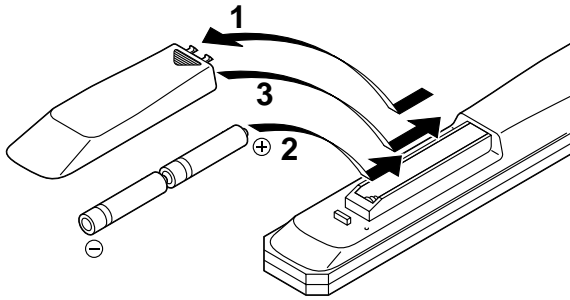

Battery replacement

If you notice that the remote control must be used closer to the main unit, the batteries are weak. Replace both batteries with new ones.

Notes

- Use AA, R6, UM-3 batteries.
- Be sure the polarities are correct. (See the illustration inside the battery compartment.)
- Remove the batteries if the remote control is not used for an extended period of time.
- If batteries leak, dispose of them immediately. Avoid touching the leaked material and contact with clothing, etc. Clean the battery compartment thoroughly before installing new batteries.

Remote control operation range

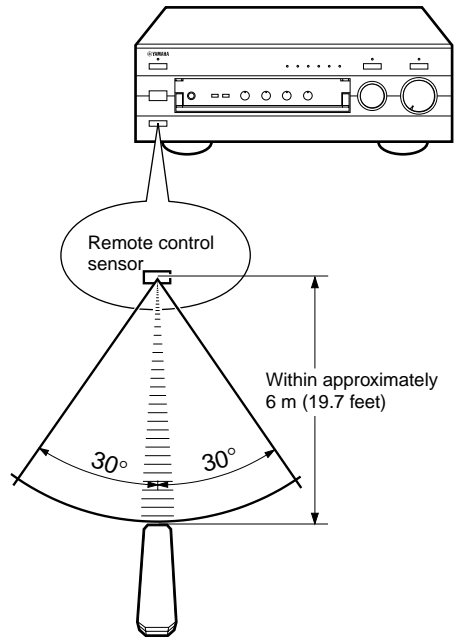

Notes

- The area between the remote control and the main unit must be clear of large obstacles.
- Do not expose the remote control sensor to strong lighting, in particular, an inverter type fluorescent lamp; otherwise, the remote control may not work properly. If necessary, position the main unit away from direct lighting.

CONNECTIONS

Caution: Plug in this unit and other components after all connections are completed.

- All connections must be correct, that is to say L (left) to L, R (right) to R, “+” to “+” and “-” to “-”. Also refer to the owner’s manual for each of your components.
- Use RCA type pin plug cables for audio/video units except speakers.
- The output (or input) terminals of YAMAHA audio/video units numbered 1, 2, 3, 4, etc. on the rear panel must be connected to the same-numbered terminals of this unit.

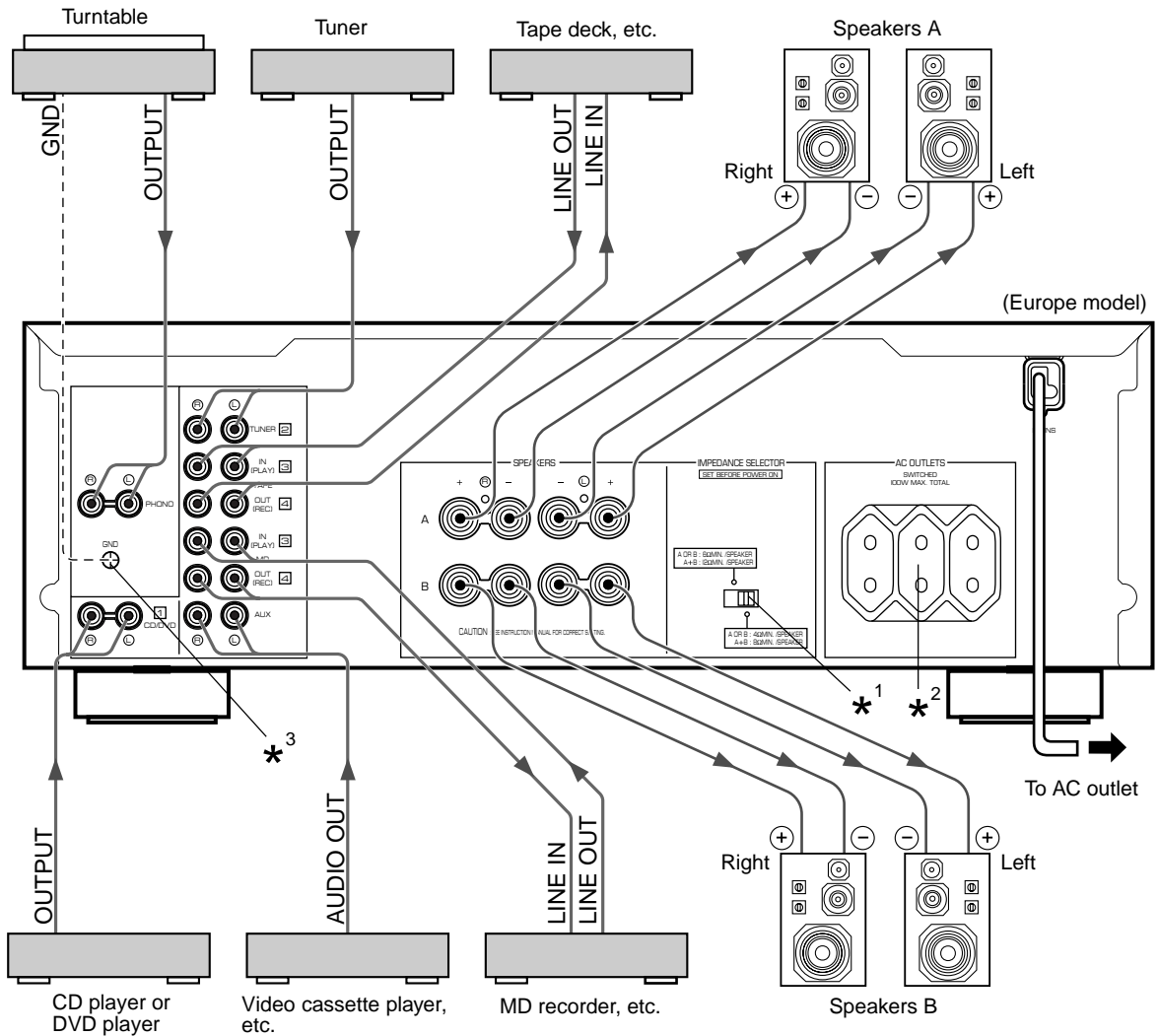

*¹, *², *³: Refer to page 5 for descriptions.

→: Indicates the direction of signals.

Connecting speakers

Connect the **SPEAKERS** terminals to your speakers with the wire with the proper gauge (keep it as short as possible). If the connections are faulty, no sound will be heard from the speakers. Make sure that the + and – polarity markings of the speaker wires are observed and set correctly. If these wires are reversed, the sound will be unnatural and lack bass.

Caution

Do not let the bare speaker wires touch each other or any metal part of this unit. This could damage this unit or the speakers, or both.

How to Connect:

Red: positive (+)
Black: negative (–)

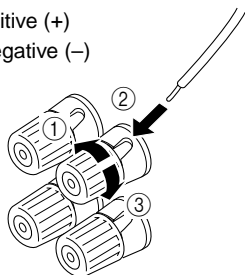

- ① Loosen the knob.
- ② Insert the bare wire.
[Remove approx. 10 mm (3/8") insulation from the speaker wires.]
- ③ Tighten the knob and secure the wire.

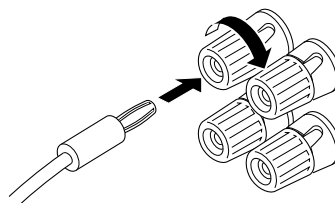

- One or two speaker systems can be connected to this unit. If you use only one speaker system, connect it to either the **SPEAKERS A** or **B** terminals.
- Use speakers with the specified impedance shown on the rear of this unit.
- **<Australia, China and General models only>**
Banana Plug connections are also possible. Simply insert the Banana Plug connector into the corresponding terminal.

Rear panel parts

IMPEDANCE SELECTOR switch *¹

WARNING

Do not change the IMPEDANCE SELECTOR switch setting while the power to this unit is on, otherwise this unit may be damaged.

If this unit fails to turn on when the **POWER** switch is pressed:
The **IMPEDANCE SELECTOR** switch may not be set to either end. If so, set the switch to either end when this unit's power supply is completely cut off.

Select the position whose requirements your speaker system meets.

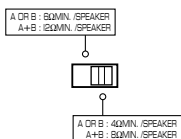

(Right position)

If you use one pair of speakers, the impedance of each speaker must be 4Ω or higher.
If you use two pairs of speakers, the impedance of each speaker must be 8Ω or higher.



(Left position)

If you use one pair of speakers, the impedance of each speaker must be 6Ω or higher.
If you use two pairs of speakers, the impedance of each speaker must be 12Ω or higher.

AC OUTLET(S) (SWITCHED) *²

(Europe, China and General models)

..... 3 SWITCHED OUTLETS
(U.K. and Australia models) 1 SWITCHED OUTLET

Use these to connect the power cords of your components to this unit.

The power to the **SWITCHED** outlets is controlled by this unit's **POWER** or **STANDBY/ON** switch. These outlets will supply power to any connected unit whenever this unit is turned on.

The maximum power (total power consumption of components) that can be connected to the **SWITCHED AC OUTLETS** is 100W.

GND terminal (For turntable use) *³

Connecting the ground wire of the turntable to the **GND** terminal will normally minimize hum, but in some cases better results may be obtained with the ground wire disconnected.

CONTROLS AND THEIR FUNCTIONS

FRONT PANEL

AX-496

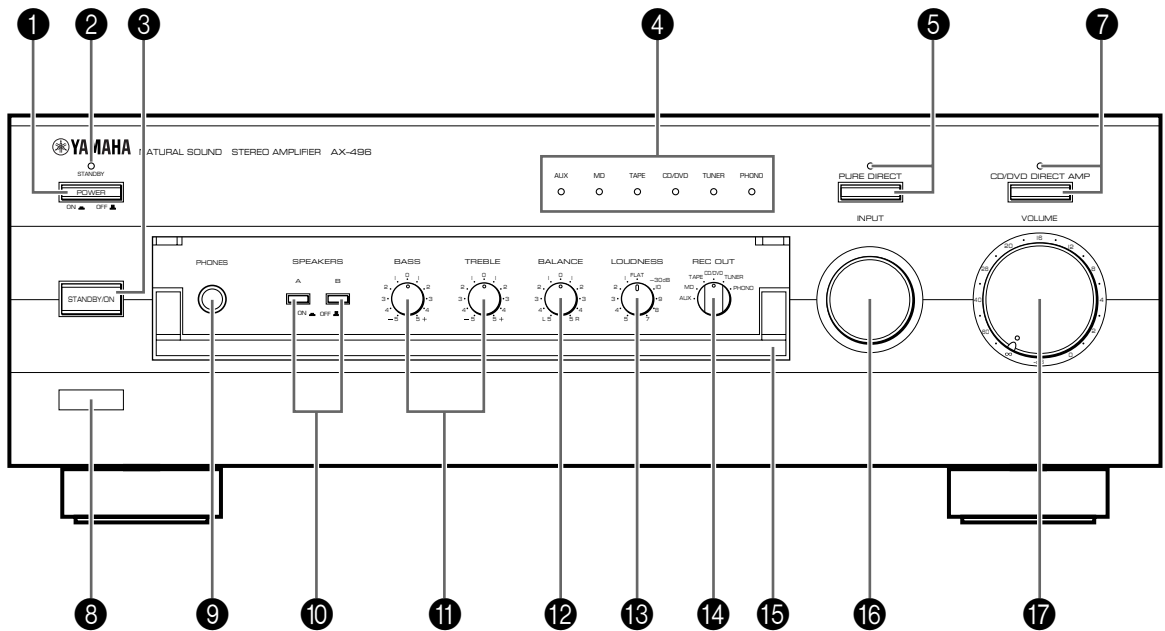

AX-396

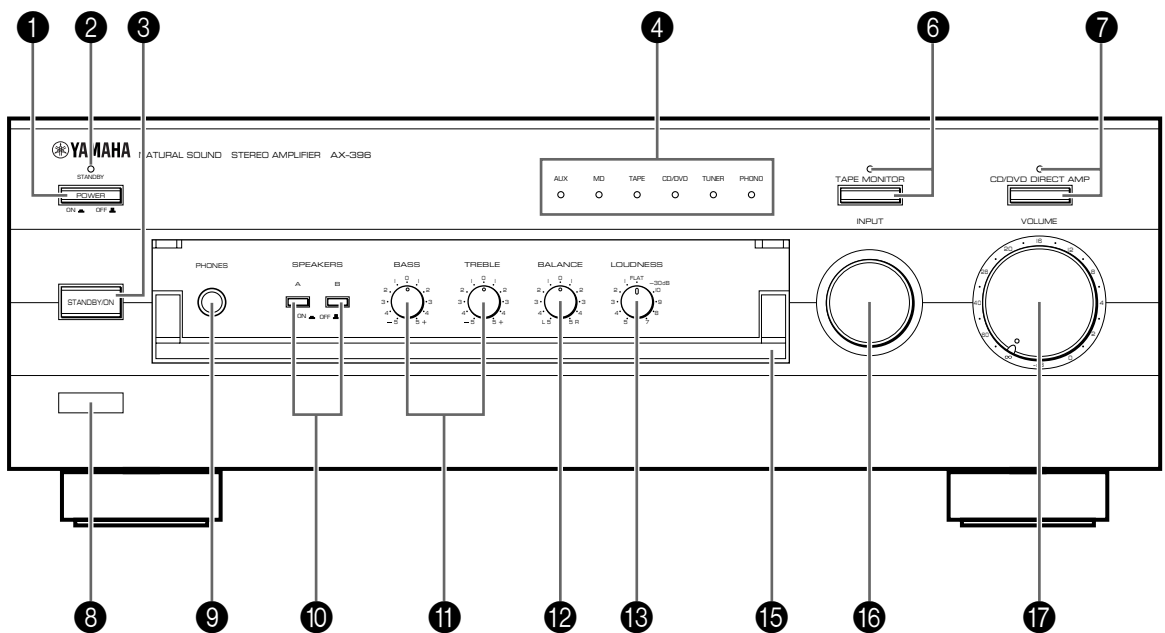

- 1 POWER**
Press this switch inward (ON) to use this unit. In this state, you can turn on this unit or turn this unit in the standby mode by pressing **STANDBY/ON**. Press this switch to release it outward (OFF) to completely cut off this unit's power supply from the AC line.

- 2 STANDBY indicator**
Lights up only while this unit is in the standby mode.

- 3 STANDBY/ON**
Press this switch to turn on the power. Press again to set this unit in the standby mode.
* This switch can be used only when **POWER** is set in the ON position.

Standby mode
This unit is still using a small amount of power in this mode in order to be ready to receive infrared-signals from the remote control.

- 4 Input source indicators**
The indicator of the currently selected input source lights up.

- 5 PURE DIRECT and indicator** **AX-496 only**
Press this switch, and the indicator above it lights up. You can listen to a source in the purest sound with this function. (Refer to page 12 for details.)
Press this switch again to cancel this function.

- 6 TAPE MONITOR and indicator** **AX-396 only**
Press this switch to turn on the indicator above it. You can listen to the sound played on the tape deck connected to the TAPE terminals on the rear of this unit. When the tape deck is used for recording, you can also monitor the sound being recorded.
* To listen to the source selected with the **INPUT** selector, press this switch again to turn off the indicator.
* When this function is on (the indicator is illuminated), the tape deck (TAPE) cannot be selected with the **INPUT** selector.
* When the tape deck (TAPE) is selected with the **INPUT** selector, this function will not turn on even if **TAPE MONITOR** is pressed.

- 7 CD/DVD DIRECT AMP and indicator**
Press this switch, and the indicator above it lights up. You can listen to a CD or DVD source in the purest sound with this function. (Refer to page 12 for details.)
Press this switch again to cancel this function.

- 8 Remote control sensor**
Receives signals from the remote control.

- 9 PHONES jack**
When you listen with headphones, connect the headphones to the **PHONES** jack and set both **SPEAKERS A** and **B** switches to the OFF position.

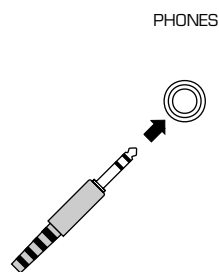

- 10 SPEAKERS**
Press the switch **A** or **B** (or both) inward (ON) for the speakers you will use. Press and release the switch outward (OFF) for the speakers you do not use.

- 11 Tone controls**
BASS
Rotate this knob to increase or decrease the low frequency response. The 0 position produces a flat response.
TREBLE
Rotate this knob to increase or decrease the high frequency response. The 0 position produces a flat response.

- 12 BALANCE**
The balance of the output volume to the left and right speakers can be adjusted to compensate for sound imbalances caused by the speaker location or listening room conditions.

- 13 LOUDNESS**
Used to compensate for the human ears' loss of sensitivity to high and low-frequency ranges at low volume. (Refer to page 12 for details.)

- 14 REC OUT selector** **AX-496 only**
Rotate this knob to select the source for recording to an MD recorder or tape deck. This setting is independent of the **INPUT** selector setting, so this function allows you to record the selected source while listening to another source.

- 15 Front cover**
Refer to inside of the front cover on how to open and close the front cover.

- 16 INPUT selector**
Turn this knob to select the input source. The selected source will be shown by the lighting of corresponding input source indicator.

- 17 VOLUME**
Turn this knob to raise or lower the volume level. (The REC OUT level is not affected.)

REMOTE CONTROL

The remote control is designed to control the most commonly used functions of the main unit. If you have a YAMAHA CD player, tuner, tape deck, etc. with remote control compatibility, this remote control will also control their various functions.

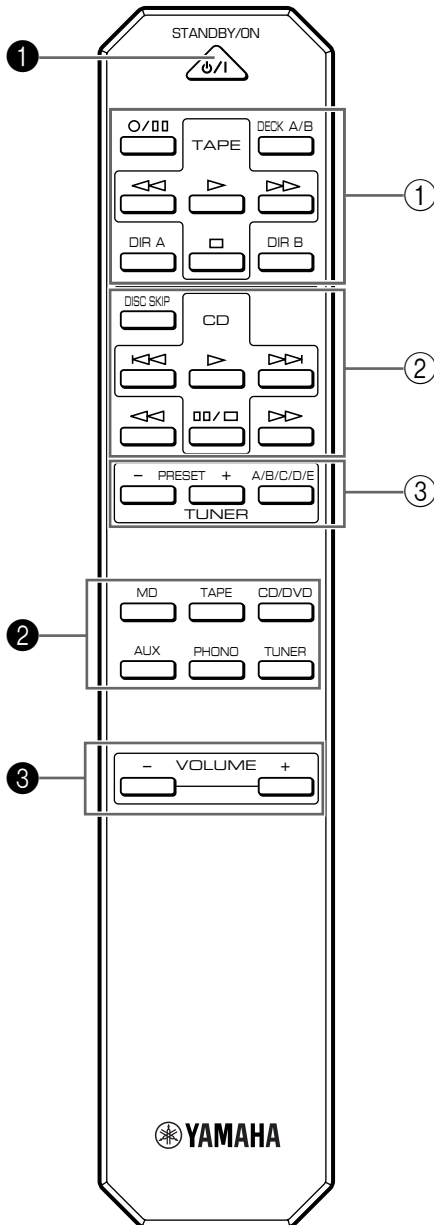

For Control of This Unit

1 STANDBY/ON

Press this key to turn on this unit or turn it into the standby mode.

This key can be used only when the **POWER** switch on the main unit is set in the ON position.

Standby mode

In this state, this unit consumes a very small quantity of power to receive infrared-signals from the remote control.

2 Input selector keys

Press a key to select the input source.

3 VOLUME +/-

Press these keys to increase or decrease the volume.

For Control of Other Components

Note

The functions of the keys to control other YAMAHA components are the same as the corresponding keys on those components. Refer to those components' instruction manuals for details.

1 Tape deck keys

These keys control tape decks.

* **DIR A, B** and **A/B** apply only to double cassette tape decks.

* Pressing **DIR A** will reverse the tape direction on a single cassette tape deck with the automatic reverse function.

2 CD player keys

These keys control compact disc players.

* **DISC SKIP** is used for disc changers only.

3 Tuner keys

These keys control tuners.

PRESET +: Press this key to select the next preset station number.

PRESET -: Press this key to select the previous preset station number.

A/B/C/D/E: Press this key to select the group (A – E) of preset station numbers.

■ Playing a source

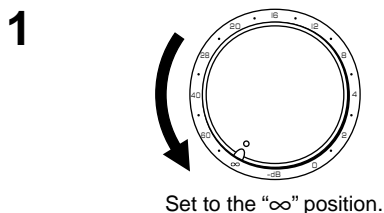
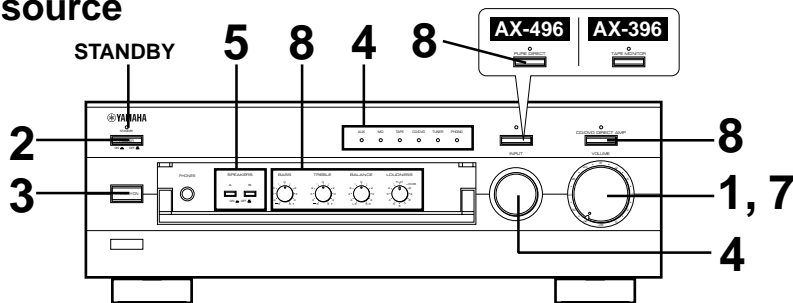

2 Press **POWER** inward (ON).

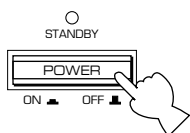

3 If the **STANDBY** indicator is illuminated, press **STANDBY/ON** to turn on the power. (The **STANDBY** indicator turns off.)

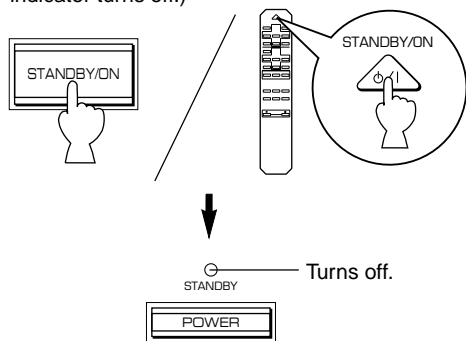

4 Select the desired input source.

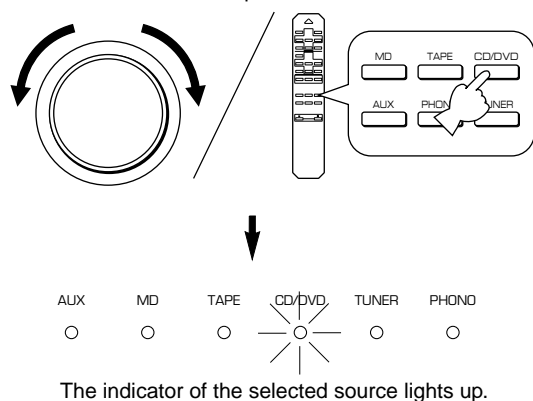

5 Select speakers A or B.

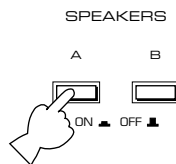

- * Both speakers A and B can be selected.
- * Be sure that the **IMPEDANCE SELECTOR** switch is correctly set as explained on page 5.
- * If you listen with headphones, press both switches to release them outward (OFF).

6 Play the source.

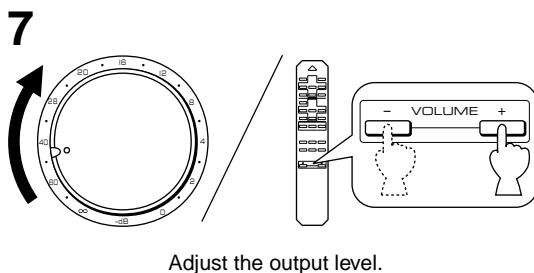

8 Adjust the tonal quality by using the **BASS**, **TREBLE**, **BALANCE**, **LOUDNESS** controls or the **CD/DVD DIRECT AMP** switch (or **PURE DIRECT** switch for AX-496 only). (Refer to page 12).

AX-396 only

If the **TAPE MONITOR** indicator is illuminated when you listen to a source, press **TAPE MONITOR** to turn off the **TAPE MONITOR** indicator.

When you finish using this unit

Press **STANDBY/ON** again to set this unit in the standby mode. (The **STANDBY** indicator lights up.)

To completely cut off this unit's power supply from the AC line

Press **POWER** to release it outward (OFF).

■ Recording a source to tape (or MD)

AX-496

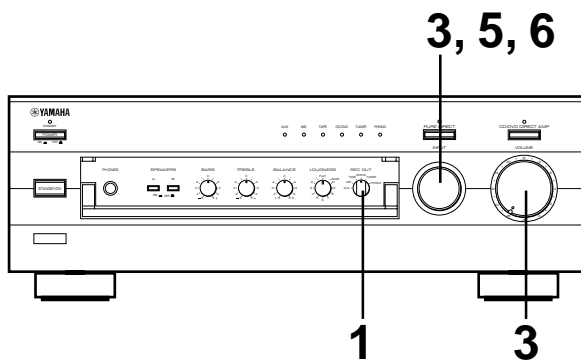

1 Select the source you want to record.

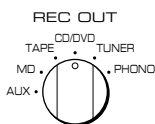

2 Play the source.

3 Select the source with the **INPUT** selector and adjust **VOLUME** to check the sound output.

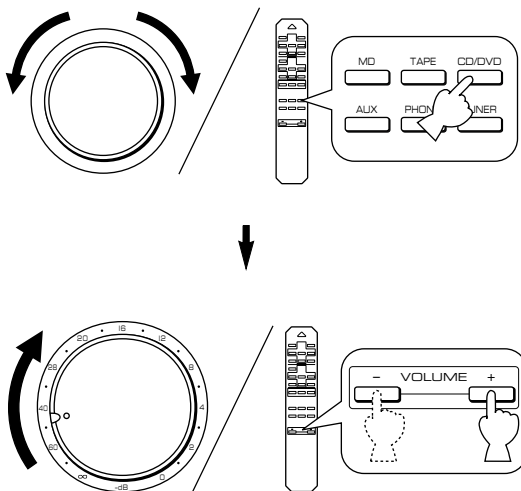

4 Begin recording on the tape deck (or MD recorder).

5 The sound of the recording can be monitored by selecting the tape deck (or MD recorder) with the **INPUT** selector.

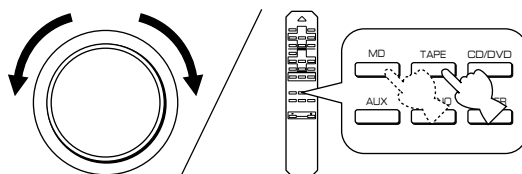

6 Listening to another source by selecting it with the **INPUT** selector will not affect the recording.

AX-396

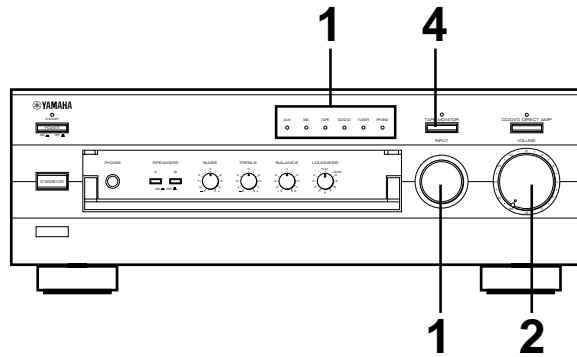

- 1** Select the source you want to record.

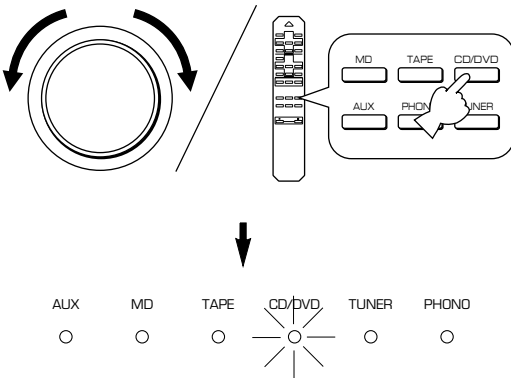

- 2** Play the source and then turn **VOLUME** up to check the sound output.

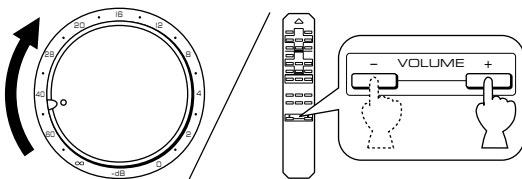

- 3** Begin recording on the tape deck (or MD recorder).

- 4** If the tape deck is used for recording, you can monitor the sound of recording.
To monitor the sound of recording, light up the **TAPE MONITOR** indicator by pressing **TAPE MONITOR**.

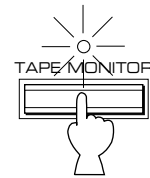
**Note**

Turn off the **TAPE MONITOR** indicator when the recording is finished by pressing **TAPE MONITOR**.

Notes on recording

- The **VOLUME, BASS, TREBLE, BALANCE, LOUDNESS** controls and **CD/DVD DIRECT AMP** switch (and **PURE DIRECT** switch for AX-496 only) have no effect on the material being recorded.
- Please check the copyright laws in your country to record from records, compact discs, radio, etc. Recording of copyright material may infringe on copyright laws.

■ Sound control

Adjusting the BALANCE control

Adjust the balance of the output volume to the left and right speakers to compensate for sound imbalance caused by speaker location or listening room conditions.



Using the CD/DVD DIRECT AMP switch

You can enjoy the purest possible sound from your CD or DVD player by pressing this switch. The indicator above it lights up. With this function on, input signals from the CD or DVD player are sent directly to the built-in special amplifier for CD/DVD bypassing the **INPUT** selector, the **BASS**, **TREBLE**, **BALANCE** and **LOUDNESS** controls (and the **TAPE MONITOR** switch for AX-396 only), and then sent to the power amplifier. This signal routing reproduces the purest sound eliminating any alterations to the CD or DVD signals.

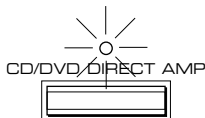

Using the PURE DIRECT switch

AX-496 only

You can enjoy the purest possible sound from your audio sources by pressing this switch. The indicator above this switch lights up. With this function on, the audio signals bypass the **BASS**, **TREBLE**, **BALANCE** and **LOUDNESS** controls, thus eliminating any alterations to the audio signals.

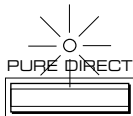

Note

If both the **CD/DVD DIRECT AMP** and **PURE DIRECT** switches are on, only the **CD/DVD DIRECT AMP** switch will function.

Adjusting the BASS and TREBLE controls

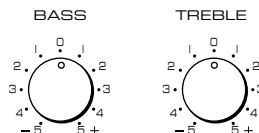

BASS: Turn this knob clockwise to increase (or counter-clockwise to decrease) the low frequency response.

TREBLE: Turn this knob clockwise to increase (or counter-clockwise to decrease) the high frequency response.

Adjusting the continuously variable LOUDNESS control

This control compensates for the human ears' loss of sensitivity to high and low-frequency ranges at low volume. This control is adjustable to retain full tonal range at any volume level.

1 LOUDNESS

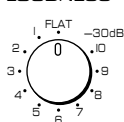

Set to the "FLAT" position.

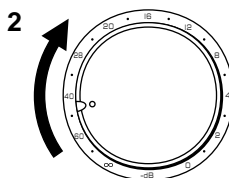

Set to the loudest listening level that you would listen to.

3 LOUDNESS

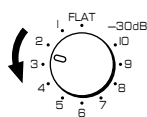

Turn until the desired volume is obtained.

WARNING

If the **CD/DVD DIRECT AMP** switch (or **PURE DIRECT** switch for AX-496 only) is pressed to turn it on with the **LOUDNESS** control set at a certain level, the sound will suddenly increase and may damage your ears or the speakers. (The **LOUDNESS** control function may be bypassed.) For this reason, be sure to press the **CD/DVD DIRECT AMP** switch (or **PURE DIRECT** switch for AX-496 only) after lowering the volume or after checking that the **LOUDNESS** control is properly set.

TROUBLESHOOTING

Refer to the chart below when this unit does not function properly. If the problem you are experiencing is not listed below or if the instructions given below do not help, disconnect the power cord and contact your authorized YAMAHA dealer or service center.

Problem	Cause	What to Do
The unit cannot be turned on or turns off suddenly soon after the power is turned on.	Power cord is not plugged in nor completely inserted.	Firmly plug in the power cord.
	The IMPEDANCE SELECTOR switch on the rear panel is not set to either end.	Set the switch to either end when this unit is off.
This unit does not work normally.	There is an influence of strong external noise (lightning, excessive static electricity, etc.) or a misoperation on this unit while using this unit.	Turn off this unit by pressing the POWER switch. After about 30 seconds have passed, turn on this unit and operate this unit again.
No sound.	Incorrect output cord connections.	Connect the cords properly. If the problem persists, the cords may be defective.
	Appropriate input source is not selected.	Select an appropriate input source with the INPUT selector.
	The SPEAKERS switches are not set properly.	Set the corresponding SPEAKERS switch to the ON position.
	Speaker connections are not secure.	Secure the connections.
The sound suddenly goes off.	The protection circuit has been activated because of short circuit etc.	Turn off this unit by pressing the POWER switch, and then turn this unit on to reset the protection circuit.
Only one of the speakers produces the sound.	Incorrect setting of the BALANCE control.	Adjust it to the appropriate position.
	Incorrect cord connections.	Connect the cords properly. If the problem persists, the cords may be defective.
There is a lack of bass and no ambience.	The + and – wires are connected in reverse at the amplifier or speakers.	Connect the speaker wires in the correct phase (+ and –).
Sound “hums”.	Incorrect cord connections.	Firmly connect the audio plugs. If the problem persists, the cords may be defective.
	No connection from the turntable to the GND terminal.	Make the GND connection between the turntable and this unit.
The volume level is low while playing a record.	The record is being played on a turntable with an MC cartridge.	The turntable should be connected to this unit through the MC head amplifier.
The volume level cannot be increased, or sound is distorted.	The component connected to the TAPE OUT or MD OUT terminals of this unit is turned off.	Turn on the power to the component.
The sound is degraded when listening with the headphones connected to the compact disc player or tape deck that are connected with this unit.	This unit is turned off or in the standby mode.	Turn on the power to this unit.
Sound level is low.	The LOUDNESS control is functioning.	Set the LOUDNESS control to the FLAT position.
The input source cannot be changed, though the INPUT selector is turned.	The CD/DVD DIRECT AMP switch is ON.	Switch off the CD/DVD DIRECT AMP switch.
Using the BASS, TREBLE, BALANCE and LOUDNESS controls does not affect the tone.	The CD/DVD DIRECT AMP switch (or PURE DIRECT switch for AX-496 only) is ON.	The CD/DVD DIRECT AMP switch (or PURE DIRECT switch for AX-496 only) must be switched OFF to use those controls.
The remote control does not work.	The batteries of this remote control are weak.	Replace the batteries with new ones.
The remote control does not function properly.	Wrong distance or angle.	The remote control will function from a maximum range of 6 meters and no more than 30 degrees off-axis from the front panel.
	Direct sunlight or lighting (of an inverter type fluorescent lamp etc.) is striking the remote control sensor of the main unit.	Reposition of the main unit.

SPECIFICATIONS

Power Section

Minimum RMS Output Power

8 Ω , 20 Hz to 20 kHz, 0.019% THD	
<AX-496>	85W+85W
<AX-396>	60W+60W

Maximum Output Power (EIAJ)

(1 kHz, 10% THD)

<AX-496>	
8/6 Ω	130/150W
<AX-396>	
6 Ω	110W

Dynamic Power (IHF)

8/6/4/2 Ω

<AX-496>	130/150/185/220W
<AX-396>	100/120/140/150W

DIN Standard Output Power

(4 Ω , 1 kHz, 0.7% THD)

<AX-496>	120W
<AX-396>	95W

IEC Output Power (8 Ω , 1 kHz, 0.019% THD)

<AX-496>	100W
<AX-396>	75W

Power Band Width

8 Ω , Half power, 0.04% THD 10 Hz to 50 kHz

Damping Factor

8 Ω , 20 Hz to 20 kHz 240

Frequency Response 20 Hz to 20 kHz \pm 0.5 dB

Total Harmonic Distortion (20 Hz to 20 kHz)

CD/DVD to SP OUT (8 Ω , Half power) 0.008%

Signal-to-Noise Ratio (IHF-A Network)

CD/DVD (Input Shorted, CD/DVD DIRECT AMP: ON)	
.....	110 dB
PHONO (Input Shorted)	88 dB

Residual Noise (IHF-A Network)

CD/DVD DIRECT AMP: ON 35 μ V

Control Section

Input Sensitivity/Impedance

CD/DVD, etc.	150 mV/47 k Ω
PHONO	2.5 mV/47 k Ω

Output Level

REC OUT 150 mV/1.6 k Ω

Headphone Output 0.25V/680 Ω

Channel Separation (1 kHz/10 kHz)

CD/DVD (Input 5.1 k Ω Terminated) 65 dB/50 dB

Tone Control Characteristics

BASS	\pm 10 dB (20 Hz)
TREBLE	\pm 10 dB (20 kHz)

Continuous LOUDNESS Control

Attenuation -30 dB (1 kHz)

General

Power Supply

[Europe and U.K. models]	AC 230V, 50 Hz
[Australia model]	AC 240V, 50 Hz
[China model]	AC 220V, 50 Hz
[General model]	AC 110/120/220/240V, 60/50 Hz

Power Consumption

<AX-496>	Approx. 210W
<AX-396>	Approx. 150W

AC Outlets

3 SWITCHED OUTLETS

[Europe, China and General models] 100W max. total

1 SWITCHED OUTLET

[U.K. and Australia models] 100W max. total

Dimensions (W x H x D) 435 x 151 x 391 mm
(17-1/8" x 5-15/16" x 15-3/8")

Weight

<AX-496>	9.5 kg (21 lbs.)
<AX-396>	8.7 kg (19 lbs. 3 oz.)

Accessories Remote control
Batteries

Specifications subject to change without notice.



YAMAHA ELECTRONICS CORPORATION, USA 6660 ORANGETHORPE AVE., BUENA PARK, CALIF. 90620, U.S.A.
YAMAHA CANADA MUSIC LTD. 135 MILNER AVE., SCARBOROUGH, ONTARIO M1S 3R1, CANADA
YAMAHA ELECTRONIK EUROPA G.m.b.H. SIEMENSSTR. 22-34, 25462 RELLINGEN, BEI HAMBURG, F.R. OF GERMANY
YAMAHA ELECTRONIQUE FRANCE S.A. RUE AMBROISE CROIZAT BP70 CROISSY-BEAUBOURG 77312 MARNE-LA-VALLEE CEDEX02, FRANCE
YAMAHA ELECTRONICS (UK) LTD. YAMAHA HOUSE, 200 RICKMANSWORTH ROAD WATFORD, HERTS WD1 7JS, ENGLAND
YAMAHA SCANDINAVIA A.B. J A WETTERGRENS GATA 1, BOX 30053, 400 43 VASTRA FRÖLUNDA, SWEDEN
YAMAHA MUSIC AUSTRALIA PTY, LTD. 17-33 MARKET ST., SOUTH MELBOURNE, 3205 VIC., AUSTRALIA

YAMAHA CORPORATION