

YAMAHA
GW50
GUITAR PERFORMANCE EFFECTOR

Owner's Manual

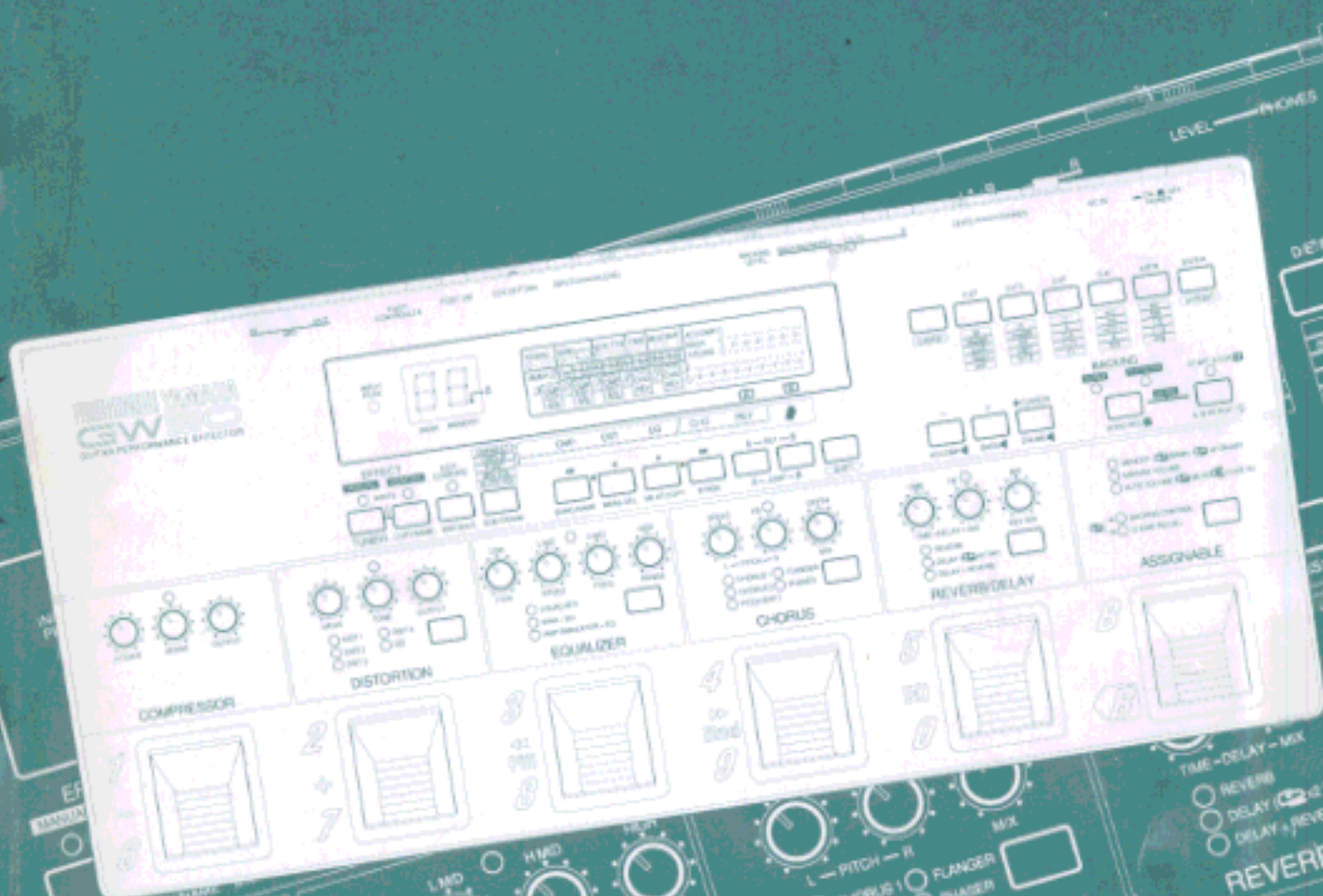

TUNER COPY/PASTE

DRIVE
DIST 1
DIST 2
DIST 3
TONE
DIST 4
OD
OUTPUT

DISTORTION

LOW
TYPE
L/MID
SPEED
EQUALIZER
WAI + EQ
AMP SIMULATOR + EQ
HIGH
FREQ
RANGE

EQUALIZER

L - PITCH - R
CHORUS 1
CHORUS 2
PITCH SHIFT
FLANGER
PHASER
MIX

CHORUS

TIME-DELAY - MIX
REVERB
DELAY (2 or 1/4)
DELAY + REVERB

REVERB/DELAY

2
+

3
FM
8

4
End
9

5

FCC INFORMATION (U.S.A.)

1. IMPORTANT NOTICE: DO NOT MODIFY THIS UNIT!

This product, when installed as indicated in the instructions contained in this manual, meets FCC requirements. Modifications not expressly approved by Yamaha may void your authority, granted by the FCC, to use the product.

2. IMPORTANT:

When connecting this product to accessories and/or another product use only high quality shielded cables. Cable/s supplied with this product MUST be used. Follow all installation instructions. Failure to follow instructions could void your FCC authorization to use this product in the USA.

3. NOTE:

This product has been tested and found to comply with the requirements listed in FCC Regulations, Part 15 for Class "B" digital devices. Compliance with these requirements provides a reasonable level of assurance that your use of this product in a residential environment will not result in harmful interference with other electronic devices. This equipment generates/uses radio frequencies and, if not installed and used according to the instructions found in the users manual, may cause interference harmful to the operation of other electronic devices. Compliance with FCC regulations does not guarantee that interference will not occur in all installations. If this product is found to be the source of interference, which can be determined by turning the unit "OFF" and "ON", please try to eliminate the problem by using one of the following measures:

Relocate either this product or the device that is being affected by the interference.

Utilize power outlets that are on different branch (circuit breaker or fuse) circuits or install AC line filter/s.

In the case of radio or TV interference, relocate/reorient the antenna. If the antenna lead-in is 300 ohm ribbon lead, change the lead-in to co-axial type cable.

If these corrective measures do not produce satisfactory results, please contact the local retailer authorized to distribute this type of product. If you can not locate the appropriate retailer, please contact Yamaha Corporation of America, Electronic Service Division, 6600 Orangethorpe Ave, Buena Park, CA 90620

The above statements apply ONLY to those products distributed by Yamaha Corporation of America or its subsidiaries.

* This applies only to products distributed by YAMAHA CORPORATION OF AMERICA.

Litiumbatteri!

Bör endast bytas av servicepersonal.
Explosionsfara vid felaktig hantering.

VAROITUS!

Lithiumparisto, Räjähdyksvaara.
Pariston saa vaihtaa ainoastaan alan ammattimies.

ADVARSEL!

Lithiumbatteri!
Eksplosionsfare. Udskiftning må kun foretages af en sagkyndig, – og som beskrevet i servicemanualen.

CANADA

THIS DIGITAL APPARATUS DOES NOT EXCEED THE "CLASS B" LIMITS FOR RADIO NOISE EMISSIONS FROM DIGITAL APPARATUS SET OUT IN THE RADIO INTERFERENCE REGULATION OF THE CANADIAN DEPARTMENT OF COMMUNICATIONS.

LE PRESENT APPAREIL NUMERIQUE N'EMET PAS DE BRUITS RADIOELECTRIQUES DEPASSANT LES LIMITES APPLICABLES AUX APPAREILS NUMERIQUES DE LA "CLASSE B" PRESCRITES DANS LE REGLEMENT SUR LE BROUILLAGE RADIOELECTRIQUE EDICTE PAR LE MINISTERE DES COMMUNICATIONS DU CANADA.

* This applies only to products distributed by YAMAHA CANADA MUSIC LTD.
* Ceci ne s'applique qu'aux produits distribués par Yamaha Canada Musique Ltée.

SPECIAL MESSAGE SECTION

This product utilizes an external power supply (adapter). DO NOT connect this product to any power supply or adapter other than one described in the manual, on the name plate, or specifically recommended by Yamaha.

WARNING: Do not place this product in a position where anyone could walk on, trip over, or roll anything over power or connecting cords of any kind. The use of an extension cord is not recommended! If you must use an extension cord, the minimum wire size for a 25' cord (or 1 cm) is 18 AWG. **NOTE:** The smaller the AWG number, the larger the current handling capacity. For longer extension cords, consult a local electrician.

This product should be used only with the components supplied, or a cart, rack, or stand that is recommended by Yamaha. If a cart, etc., is used, please observe all safety markings and instructions that accompany the accessory product.

SPECIFICATIONS SUBJECT TO CHANGE: The information contained in this manual is believed to be correct at the time of printing. However, Yamaha reserves the right to change or modify any of the specifications without notice or obligation to update existing units.

Do not attempt to service this product beyond that described in the user-maintenance instructions. All other servicing should be referred to qualified service personnel.

This product, either alone or in combination with an amplifier and headphones or speaker/s, may be capable of producing sound levels that could cause permanent hearing loss. DO NOT operate for long periods of time at a high volume level or at a level that is uncomfortable. If you experience any hearing loss or ringing in the ears, you should consult an audiologist. **IMPORTANT:** The louder the sound, the shorter the time period before damage occurs.

Some Yamaha products may have benches and/or accessory mounting fixtures that are either supplied with the product or as optional accessories. Some of these items are designed to be dealer assembled or installed. Please make sure that benches are stable and any optional fixtures (where applicable) are well secured BEFORE using. Benches supplied by Yamaha are designed for seating only. No other uses are recommended.

NOTICE: Service charges incurred due to lack of knowledge relating to how a function or effect works (when the unit is operating as designed) are not covered by the manufacturer's warranty, and are therefore the owner's responsibility. Please study this manual carefully and consult your dealer before requesting service.

ENVIRONMENTAL ISSUES: Yamaha strives to produce products that are both user safe and environmentally friendly. We sincerely believe that our products and the production methods used to produce them, meet these goals. In keeping with both the letter and the spirit of the law, we want you to be aware of the following:

Battery Notice: This product MAY contain a small non-rechargeable battery which (if applicable) is soldered in place. The average life span of this type of battery is approximately five years. When replacement becomes necessary, contact a qualified service representative to perform the replacement.

This product may also use "household" type batteries. Some of these may be rechargeable. Make sure that the battery being charged is a rechargeable type and that the charger is intended for the battery being charged.

When installing batteries, do not mix old batteries with new, or with batteries of a different type. Batteries MUST be installed correctly. Mismatches or incorrect installation may result in overheating and battery case rupture.

Warning: Do not attempt to disassemble, or incinerate any battery. Keep all batteries away from children. Dispose of used batteries promptly and as regulated by the laws in your area. Note: Check with any retailer of household type batteries in your area for battery disposal information.

Disposal Notice: Should this product become damaged beyond repair, or for some reason its useful life is considered to be at an end, please observe all local, state, and federal regulations that relate to the disposal of products that contain lead, batteries, plastics, etc. If your dealer is unable to assist you, please contact Yamaha directly.

NAME PLATE LOCATION: The graphic below indicates the location of the name plate for this model. The model number, serial number, power requirements, etc., are located on this plate. You should record the model number, serial number, and the date of purchase in the spaces provided below and retain this manual as a permanent record of your purchase.

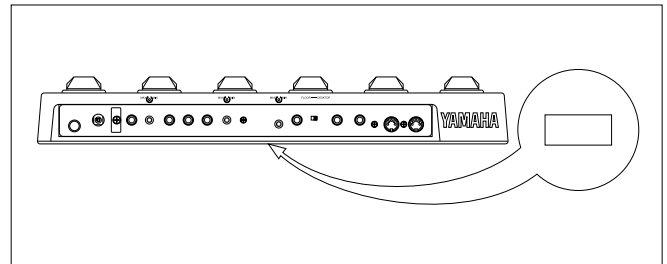

Model _____

Serial No. _____

Purchase Date _____

PLEASE KEEP THIS MANUAL

Congratulations and thank you for purchasing the Yamaha GW50 Guitar Performance Effector. The GW50 combines high-quality multi effects for guitar (and other instruments as well) with a sophisticated backing section that provides realistic automatic rhythmic accompaniment for you to play along with. The dual functions — effects and backing — make the GW50 useful in a wide range of applications, from live performance and studio use to home recording and individual music practice.

Some of the advanced features of the GW50 include:

Effect Section

- Five basic effect blocks, featuring Compressor, Distortion, Equalizer, Chorus and Reverb/Delay, plus additional effect types within each block, such as Overdrive, Wah, Amp Simulator, Flanger, Phaser, Pitch Shifter, Tap Delay, and a built-in Noise Gate.
- User memory for storing up to 50 user-created effect programs, all instantly selectable from the convenient Pedal Switches. (See pages 11, 25.)
- High-quality sound in all effects, plus added sonic benefit of having all effects integrated into one unit.
- Comprehensive parameter control over all effects, yet exceptional ease-of-use — you can adjust the main parameters of the effect blocks just as you would on conventional pedal effects.

Backing Section

- A total of 248 automatic rhythm and accompaniment patterns, using realistic drum, bass and other backing instrument sounds. (See page 32.) The automatic accompaniment includes sophisticated chord control, with 25 different chord types available in all keys. (See pages 33-35.)

- Song record capability, for creating songs with the rhythm/accompaniment patterns and chord changes, as well as automating effect program changes, effect bypass and other functions. (See pages 36-38.)
- A special Root Select function (see page 78), which lets you change the root note of the backing chord by playing the note on your guitar, and Triggered Run (see page 82), which allows you to start a song or pattern just by playing a note on your guitar.

Other Features

- Convenient Pedal Switch control over many functions, including chord change, start/stop of pattern/song playback, bypassing of effects, and so on.
- Built-in tuner, allowing you to tune your instrument without removing it from the signal chain. (See page 39.)
- Various MIDI features for interfacing with a wide range of other MIDI devices. (See pages 101-107.)

PRECAUTIONS

■ USE THE CORRECT POWER SUPPLY

Power to the GW50 should be supplied only from the appropriate **Yamaha AC adaptor (the included PA-3)**. Use of another adaptor may cause serious damage to the unit. Also make sure that the adaptor you have is appropriate for the AC mains supply voltage in the area where you intend to use the GW50. (The correct input voltage is marked on the adaptor.)

■ USE ONLY APPROPRIATE FOOT CONTROLLERS AND FOOTSWITCHES

Certain functions of the GW50 can be controlled by **the optional Yamaha FC7 Foot Controller and the FC5 (or FC4) Footswitch**. Use of any other pedal or footswitch besides those recommended here may result in erratic operation or may cause some other trouble in the foot controller or footswitch itself.

■ MEMORY BACKUP

The GW50 memorizes the following data, even when the power is turned off: **Memory effect program data, Manual effect data (excepting main parameter values), song data, and general panel settings**. The GW50 contains a special long-life lithium battery that retains this data in the internal RAM memory. The battery should last for approximately five years from the date of manufacture. When the backup battery power becomes too low to maintain the memory contents, a warning message appears in the LCD:

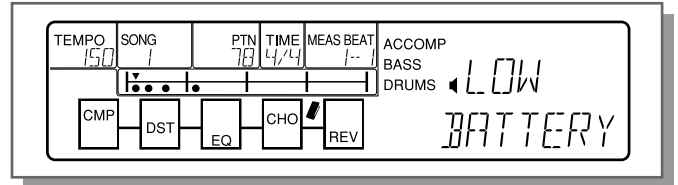

(This message appears only when the power is turned on, and stays in the LCD until a panel button is pressed.) When this happens, save all original data to a MIDI data storage device (see note below) or write down all necessary settings to a piece of paper, then **have the battery replaced** by qualified Yamaha service personnel as soon as possible. **DO NOT ATTEMPT TO REPLACE THE BACKUP BATTERY YOURSELF!**



BACKING UP DATA—We recommend that you transfer all important data to a MIDI data recorder, such as the Yamaha MDF2 MIDI Data Filer or another data storage device, for safe, long-term storage. (For more information, refer to the section on the MIDI Bulk Dump function, page 102.) Yamaha cannot be held responsible for data loss caused by battery failure or improper operation of the GW50.

■ AVOID PHYSICAL SHOCKS

Although the GW50 has been constructed to withstand the normal rigors of stage and studio use for optimum sturdiness and reliability, avoid subjecting it to strong physical shocks (such as dropping or hitting it), since this may damage the unit. Since the GW50 is a precision-made electronic device, also avoid applying excessive force to the various controls. Also, avoid stepping on any part of the GW50 other than the Pedal Switches, since this may damage or break the controls or glass of the display.

■ AVOID EXCESSIVE HEAT, HUMIDITY, DUST AND VIBRATION

Keep the unit away from locations where it is likely to be exposed to high temperatures (such as direct sunlight) or humidity. Also avoid locations which are subject to excessive dust accumulation or vibration which could cause mechanical damage.

■ DO NOT OPEN THE CASE OR ATTEMPT REPAIRS OR MODIFICATIONS YOURSELF

This product contains no user-serviceable parts. Refer all maintenance to qualified Yamaha service personnel. Opening the case and/or tampering in any way with the internal circuitry will void the warranty.

■ MAKE SURE POWER IS OFF BEFORE MAKING OR REMOVING CONNECTIONS

Always turn the power off prior to connecting or disconnecting cables.

■ HANDLE ALL CONNECTIONS CAREFULLY

Always be careful to connect and disconnect all cables and cords by gripping the connector itself, not by pulling on the cord.

■ CLEAN WITH A SOFT, DRY CLOTH

Never use solvents such as benzine or thinner to clean the unit, since these will damage the finish. Wipe clean with a soft, dry cloth. If necessary, use a soft, clean cloth slightly moistened with a diluted, mild detergent — making sure to wipe the case off again with a dry cloth.

■ ELECTRICAL INTERFERENCE

Since the GW50 contains digital circuitry, it may cause interference and noise if placed too close to TV sets, radios or similar equipment. If such a problem occurs, move the GW50 further away from the affected equipment.

■ MIDI CABLES

When connecting the GW50 to other MIDI equipment, be sure to use only high-quality cables made especially for MIDI data transmission. Also avoid cables longer than 15 meters, since long cables can result in data errors.

TABLE OF CONTENTS

PRECAUTIONS ii

HOW TO USE THIS MANUAL
(READ THIS FIRST!!) 1

THE GW50:
WHAT IT IS AND WHAT IT CAN DO 2

PANEL CONTROLS AND TERMINALS 5
 ASSIGNABLE BLOCK AND PEDAL
 SWITCH FUNCTIONS 10

**GUIDED TOUR (TUTORIAL) — SETTING UP,
PLAYING AND USING YOUR GW50**

SETTING UP AND PLAYING YOUR
GW50 19

DEMO MODE — PLAYING THE
DEMONSTRATION SONGS 22

EFFECT SECTION 24
 PLAYING WITH SOME OF THE
 EFFECTS 24
 CHANGING THE SOUND OF
 THE EFFECTS 26
 CHANGING (EDITING) AN EFFECT
 PROGRAM AND SAVING IT 29
 USING THE NOISE GATE TO GET
 A CLEAN SIGNAL 31

BACKING SECTION 32
 PLAYING PATTERNS —
 PATTERN MODE 32
 PLAYING AND RECORDING SONGS —
 SONG MODE 36

USING THE BUILT-IN TUNER 39

REFERENCE/EFFECT SECTION

ABOUT THE MANUAL, MEMORY AND
MEMORY EDIT MODES 43

MANUAL MODE 44
 Selecting an Effect Type 44
 Turning Individual Effects On and Off 44
 Editing Parameters 44
 Utility Functions 45
 Determining the Order of the Effect
 Blocks — CONNECT 45
 Bypass Switching of Effect Blocks —
 GROUP 45
 Setting the Function of the External Foot
 Controller — FOOT 46
 Setting the MINIMUM VOLUME Level
 (for External Foot Controller and
 ASSIGNABLE Block Volume Control) —
 MIN VOL 47
 ASSIGNABLE Block Functions —
 MIN/MAX Volume and Auto Volume 48
 Setting the AUTO VOLUME Rate —
 AUTO VOL 49

MANUAL JOB MODE 50
 Saving the Manual Mode Settings to
 an Effect Program 50

MEMORY MODE 51
 Selecting Effect Programs 51
 Checking Parameter Values of the Effect
 Program 51
 ASSIGNABLE Block and Pedal Switch
 Functions 51
 Effect Program Selection 51
 Bypass Switching of Effect Blocks 52

MEMORY EDIT MODE	53	SONG MODE	79
Compare Mode (Comparing the Edited Program with the Original)	53	SONG PLAY MODE (SONG PLAYBACK)	79
Saving the Memory Edit Mode Settings to an Effect Program	53	Selecting and Playing Songs	79
Recalling the Settings of the Original Program (in Compare Condition)	54	Cursor Control in Song Mode	80
MEMORY JOB MODE	54	Changing the Tempo	80
Copying an Effect Program	54	Muting the Accompaniment, Bass and Drums	80
Swapping One Effect Program with Another	55	Position Controls	81
Naming an Effect Program	55	ASSIGNABLE Block and Pedal Switch Functions in Song Mode	82
Using an External Footswitch	56	Backing Control — Selecting and Playing a Song	82
RESTORING FACTORY PRESET EFFECT PROGRAMS	57	Triggered Run	82
EFFECTS AND PARAMETERS	58	RECORDING AND EDITING SONGS	83
COMPRESSOR	58	REALTIME RECORDING MODE (REALTIME RECORDING)	83
DISTORTION	59	ASSIGNABLE Block and Pedal Switch Functions in Song Realtime Recording	86
EQUALIZER	59	Hints on Realtime Recording	87
CHORUS	63	STEP RECORDING MODE (STEP RECORDING)	88
REVERB/DELAY	66	SONG EDIT MODE (SONG EDITING)	90
NOISE GATE	69	Viewing Recorded Events	90
REFERENCE/BACKING SECTION		Editing (Changing) Recorded Events	92
PATTERN MODE	73	Erasing Recorded Events	92
Selecting and Playing Patterns	73	Set A and Set B Operations	92
Cursor Control in Pattern Mode	74	Marking Measure A and Measure B	92
Changing Chords	74	Jumping to Measure A or Measure B	92
Changing the Tempo	76	Loop (Repeat) Playback (A to B)	92
Muting the Accompaniment, Bass and Drums	76	Loop (Repeat) Recording (A to B)	93
ASSIGNABLE Block and Pedal Switch Functions in Pattern Mode	77	SONG JOB MODE	94
Backing Control	77	Copying Measures Between A and B	94
Chord Recall	77	Deleting Measures Between A and B	94
Root Select	78	Naming Songs	95
		RESTORING FACTORY PRESET SONGS ...	95

**REFERENCE/OTHER FUNCTIONS
(TUNER/MIDI)**

TUNER MODE 99

MIDI 101

 MIDI BULK TRANSMISSION MODE 102

 CHANGING EFFECT PROGRAMS ON
 THE GW50 FROM A CONNECTED
 DEVICE 103

 CHANGING PROGRAMS ON A CONNECTED
 DEVICE FROM THE GW50 104

 TURNING INDIVIDUAL EFFECTS
 ON AND OFF FROM A CONNECTED
 DEVICE 104

 SYNCHRONIZING ANOTHER DEVICE
 WITH THE GW50 105

 USING THE BACKING PATTERNS
 TO PLAY OTHER SOUND MODULES 106

APPENDICES

ERROR MESSAGES 111

TROUBLESHOOTING 114

SPECIFICATIONS 117

INDEX 119

SUPPLEMENTAL INFORMATION

BLOCK DIAGRAM 125

JOB TABLE 126

ASSIGNABLE BLOCK AND PEDAL
SWITCH FUNCTIONS CHART 128

EFFECT PARAMETER CHART 130

FACTORY SET MEMORY EFFECT
PROGRAM LIST 132

MEMORY EFFECT PARAMETER LIST 133

MANUAL EFFECT FACTORY SET
PARAMETER CHART 143

PRESET PATTERN LIST 144

DRUM AND PERCUSSION SOUNDS
USED FOR DRUM PARTS 146

FACTORY SET SONG LIST 147

MIDI SPECIFICATIONS 148

MIDI IMPLEMENTATION CHART 150

CHART OF CHORD FINGERINGS
FOR GUITAR 152

USE OF ADVANCED RECORDING TECHNIQUES
– FACTORY SET SONG 1 153

DEMO SONG 1-6 – CHORD CHARTS 156

HOW TO USE THIS MANUAL **(READ THIS FIRST!!)**

You are probably eager to try out your new GW50 right away and hear what it can do, rather than have to read through a lot of instructions before you can even get a sound out of it.

Before you do anything else, however, you should read the **PRECAUTIONS** section. This tells you briefly how to care for your new GW50, how to avoid damaging it, and how to ensure long-term, reliable operation.

Next, read through the section **The GW50: WHAT IT IS AND WHAT IT CAN DO.**

This briefly gives you an overview of the functions of the GW50 and how you can use it effectively.

The bulk of the manual has been organized into two parts: the **GUIDED TOUR (TUTORIAL)** and the **REFERENCE** section.

Read the **GUIDED TOUR (TUTORIAL)** next. It guides you step-by-step in setting up your GW50, connecting it properly, and (most importantly!) getting sound out of it. The section also goes on to take you through some of the more important functions of the GW50, explaining by way of example how to use it.

The **REFERENCE** section, on the other hand, is a comprehensive guide to all functions. You won't need (or want) to read through all of it at once, but it is there for you to refer to when you need information about a certain feature or function.

The **PANEL CONTROLS AND TERMINALS** is also mainly for reference. However, you should read through the parts here concerning the Pedal Switches, since these are particularly useful and convenient in operating the GW50. In general, look through this section to familiarize yourself with the controls, and refer to it when necessary.

The **INDEX** in the **APPENDICES** sections at the back of this manual is also very helpful. It lists and gives page numbers for virtually every function, feature, control and terminal found on the GW50, and gives you a quick, easy way to find what you're looking for.

Other parts of the **APPENDICES** and **SUPPLEMENTAL INFORMATION** sections provide additional useful information: lists of all effect programs, patterns and songs of the GW50, a list of error messages, tips on troubleshooting (when something doesn't work as expected), and other important information.

THE GW50: WHAT IT IS AND WHAT IT CAN DO

WHAT IT IS ...

Effect and Backing Sections

The GW50 is actually two different devices in one.

On the one hand, it has an Effect section which provides high-quality and easy-to-use multi effects designed especially for processing electric guitar.

On the other, it has a Backing section which provides realistic automatic rhythm, chord and bass patterns for creating your own accompaniment. Moreover, the GW50 includes a built-in tuner for tuning your instrument without having to remove it from the effect chain.

The Effect section has two mode groups: **Manual**, which lets you use the GW50 effects just as would a normal pedal effect unit, and **Memory**, which lets you call up preset effect programs and create your own original programs.

The Backing section also has two mode groups: **Pattern**, which lets you play the various rhythm patterns, and **Song**, which lets you play pre-programmed songs and create your own original songs.

Modes of the GW50

The tree chart on the next page shows the relationships of the various modes of the GW50. There are four main modes — Manual, Memory, Pattern and Song — indicated by the shaded areas. All other modes are either separate from them (as with Tuner, MIDI Bulk Transmission and Demo) or are subordinate to them.

The Effect and Backing sections are active simultaneously; however, when making adjustments or performing certain operations within a mode in one of the sections, generally you should press the desired mode button ([**MANUAL**], [**MEMORY**] or [**SONG/PATTERN**]) to make sure that the mode is properly called up before attempting the operation.

Functions in Each Mode

Specific functions and operations of the various modes include:

Manual: Changing the parameters of the effects.

Manual Job: Storing parameter settings to a program.

Memory: Selecting and using an effect program.

Memory Edit: Changing the parameters of an effect program.

Memory Edit Compare: Comparing the sound and values of edited program with the original.

Memory Job: Copying, swapping and naming effect programs.

Pattern: Playing the patterns of the Backing section.

Song: Playing a song, or using the Step Recording features to edit a song.

Song Realtime Recording: Recording events to a song in realtime.

Song Job: Copying or deleting measures within a song; naming a song.

Keep in mind as you read this manual that the phrase “main modes” refers to the Manual, Memory, Pattern and Song modes, and that “mode buttons” refers to the [**MANUAL**], [**MEMORY**] and [**SONG/PATTERN**] buttons.

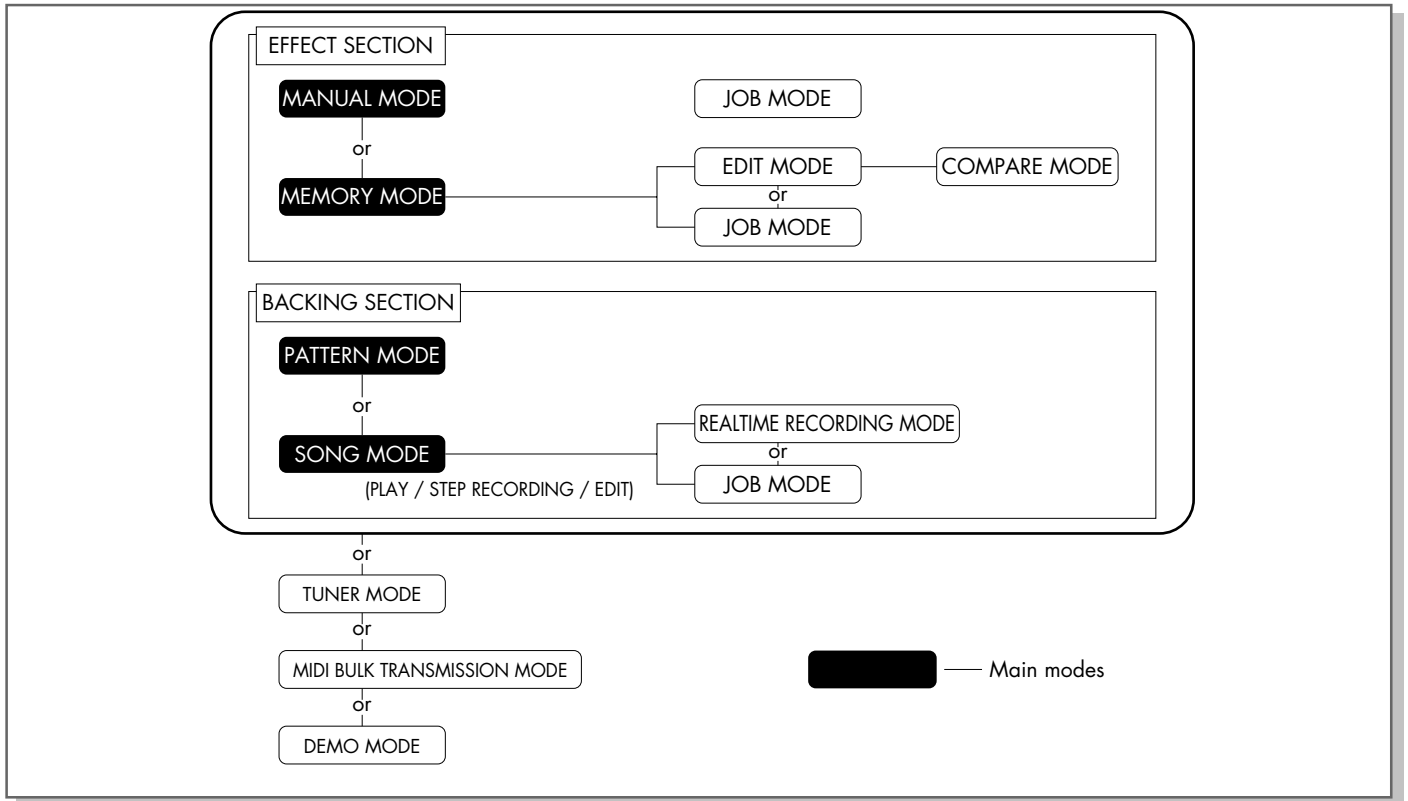

The illustration below shows what comprises an effect program (either Manual or Memory), and

the bank number/program number configuration to which they can be stored.

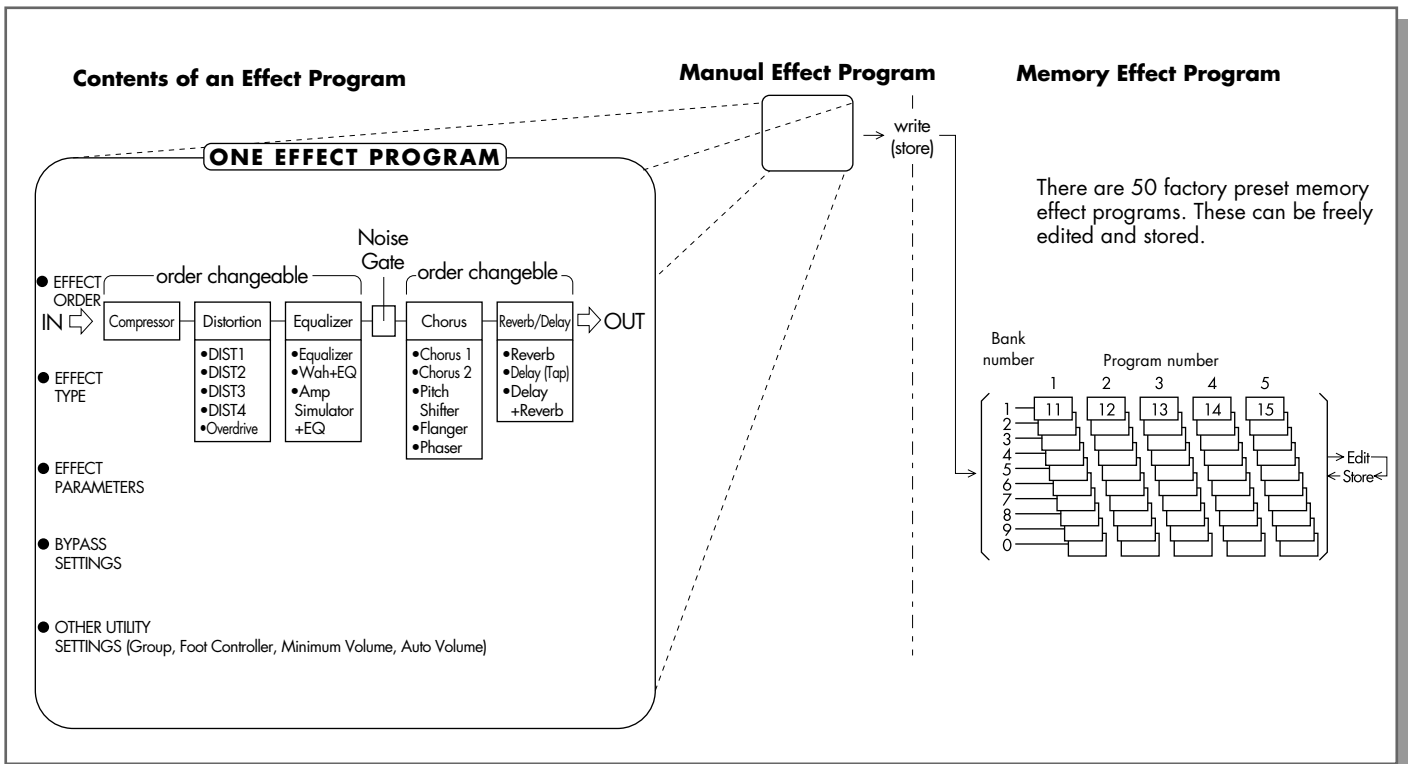

The illustration below shows how the Pattern mode and Song mode are used.

Pattern Mode

In the Pattern mode, individual patterns are played back and repeated.

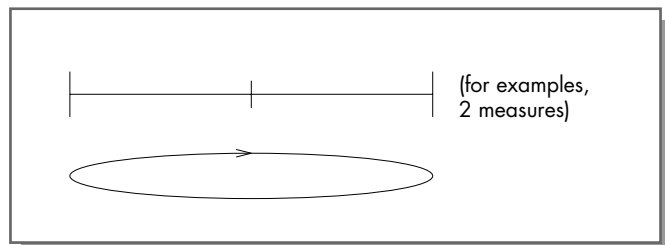

Song Mode

In the Song mode, the preset patterns can be strung together to create a song. Other events, such as chord changes and muting events, can also be entered.

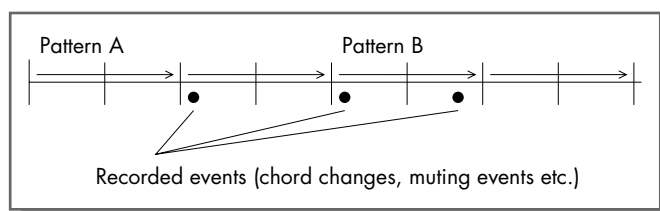

WHAT IT CAN DO ...

Here are a few ideas on how you can use your GW50. The list below is in no way comprehensive, but is meant to be a starting point or springboard for your own creative ideas and explorations.

■ All-in-one effect unit for on the stage, in the studio, or in rehearsal

With its five effect blocks, the GW50 has all you need to augment your sound, whatever the application. Any or all five effects can be used in virtually any combination as an effect program, and you can instantly select from 50 different effect programs as you play. Plus, flexible effect bypass (on/off) functions give you even more real time control over the sound.

■ Convenient practice tool

The rhythm, bass and accompaniment patterns of the GW50 are perfect for playing along with. By stringing together the rhythm patterns and recording chord changes, you can create and playback complete songs over which you can practice.

Having the full accompaniment behind you is a much more inspiring and exciting way of practicing than using just a metronome.

■ Sketchpad for composing and arranging

The accompaniment features can also be used to help you flesh out your own musical ideas. With the wealth of chords (a total of 25 different chord types for each of the 12 keys) and the convenient editing features, the GW50 makes it exceptionally easy to quickly turn your inspirations into complete songs. Plus, the extraordinarily realistic sounds give you the tools to present polished versions of your ideas to others.

Now that you have a basic idea of how the GW50 can help you in your music, go on to the GUIDED TOUR (TUTORIAL), and learn how to set up and use your GW50.

PANEL CONTROLS AND TERMINALS

This section shows and explains all of the controls and terminals of the GW50. Since the explanations below are fairly brief, you should turn to the page references given for more information on individual buttons and features.

A few general comments:

- Some of the buttons described below must be pressed together to call up a certain function. These are indicated either by a “+” mark (for example, “[SHIFT] + [SUB PARAM]”), or by the word “with” (for example, “With [SHIFT]:”).
- Markings for three of the panel controls which are used simultaneously with another control — \langle SHIFT \rangle , \langle CHORD \rangle and \langle B \rangle (for the ASSIGNABLE Block Pedal Switch) — are enclosed in a border which indicates the direction(s) in which their companion controls can be found. For example, the \langle CHORD \rangle mark points to the right, indicating that the settings **below** the buttons on the right can be selected by simultaneously pressing \langle CHORD \rangle and the appropriate button.
- Also, keep in mind that the function which is enabled — simultaneously holding down \langle SHIFT \rangle , \langle CHORD \rangle or \langle B \rangle , and pressing that button — is always printed **below** the button.
- The buttons whose primary functions are indicated in boxed titles above each button ([MANUAL], [MEMORY] and [SONG/PATTERN]) are referred to as the “mode buttons” and can be conveniently used as exit buttons to “escape” from most in-progress operations (such as Copying, Naming, MIDI Bulk Transmission, etc.).
- All controls that are used to increase or decrease values feature continuous and rapid operation, to let you more quickly and easily reach a desired value. With the [-]/[+] buttons, hold down one button to continuously move through the values and, while holding down that button, press the other to increase the speed. Releasing the second button returns to normal speed. With Pedal Switches 1 and 2 (when used for [-]/[+] control) and the Position Control buttons (<, >, etc.), holding down the appropriate control moves through the values with increasing speed.

TOP PANEL

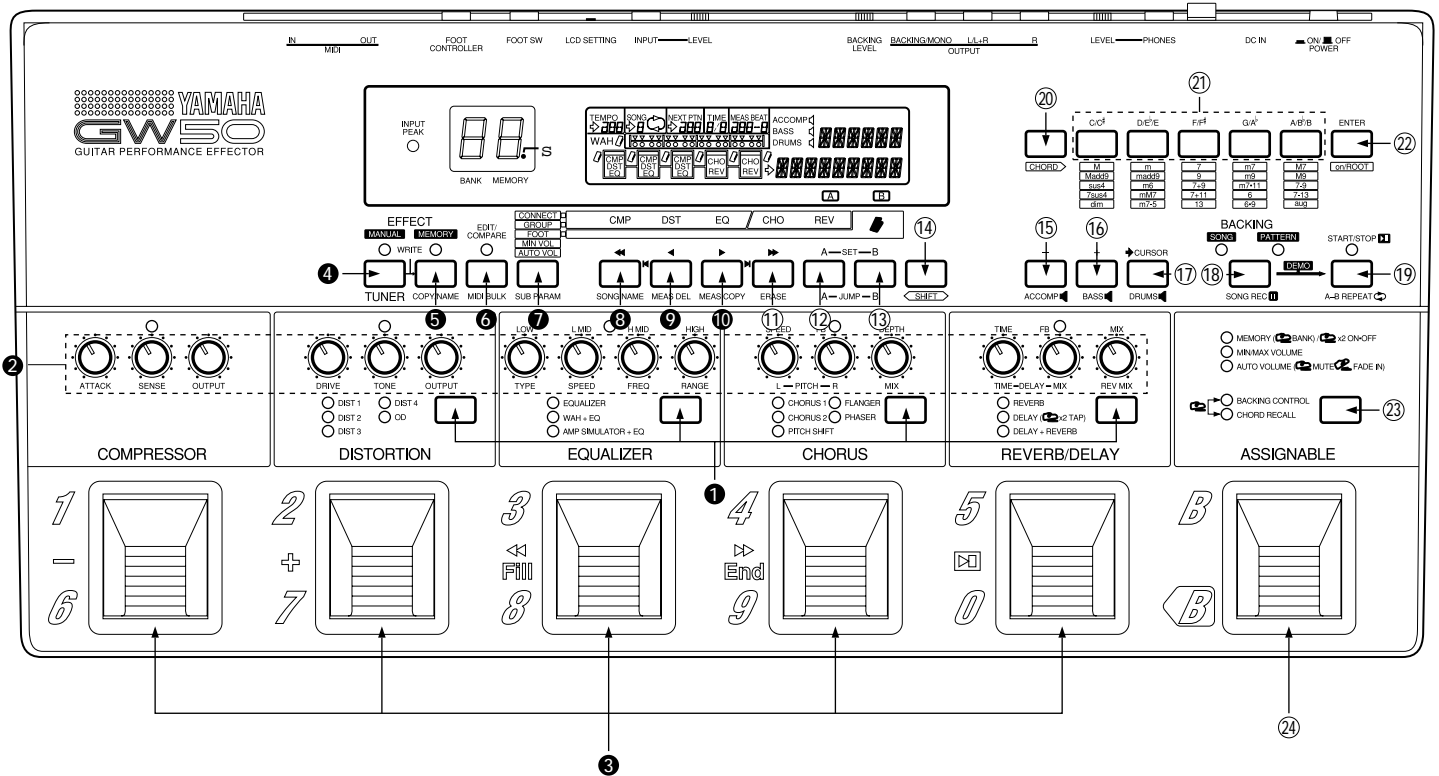

① Effect Type Switch

- For selecting the different effect types available in each effect block. These are active only in the Manual and Memory Edit modes. (See pages 26, 44.)

② Parameter Knobs

- For adjusting the main parameters of the effects. These are active only in the Manual and Memory Edit modes. (See page 26.)

③ Effect Block Pedal Switches

- The Pedal Switches have different functions depending on the mode selected.
 - In Manual mode:** For turning individual effect blocks (or groups) on and off. (See page 11.)
 - In Memory mode:** For selecting effect programs and changing the banks of the effect programs. (See page 11.) Also, when ASSIGNABLE Pedal Switch has been pressed twice quickly, for turning individual effect blocks (or groups) on and off. (See page 11.)

In Memory Edit mode: For selecting which effect blocks are active in an effect program. (See page 11.)

In Pattern mode: For performing various control functions, such as (when BACKING CONTROL is selected) selecting patterns, starting or stopping a pattern, or (in CHORD RECALL) changing to pre-assigned chords. (See page 12.)

In Song mode (playback): For performing various control functions, such as: selecting songs, fast forwarding/rewinding within a song, starting/stopping songs. (See page 13.)

In Song mode (recording): For starting or stopping song recording and selecting pre-assigned chords. (See page 13.)

- The REVERB/DELAY Pedal Switch is also used as a delay time tap control. (See page 67.)

For more information on the Pedal Switches, see the boxed section "ASSIGNABLE BLOCK AND PEDAL SWITCH FUNCTIONS" on pages 10-14.

- ④ **MANUAL (TUNER)**
- For selecting the Manual mode. Pressing this button in any operating condition calls up the Manual mode.
 - **With [SHIFT]:** For selecting the Tuner function. (See pages 39, 99.)
- ⑤ **MEMORY (COPY/NAME)**
- For selecting the Memory mode. Pressing this button in any operating condition calls up the Memory mode.
 - **With [SHIFT]:** For calling up (and toggling between) the Effect Copy, Effect Swap and Effect Name operations.
- ⑥ **EDIT/COMPARE (MIDI BULK)**
- **In Memory mode:** Selects the Memory Edit mode, and serves as a Compare switch to toggle between the newly edited settings of an effect program and its original settings (the LED flashes in the Compare condition). (See pages 29, 53.)
 - **With [SHIFT]:** For calling up the MIDI Bulk Transmission operation. (See page 102.)
- ⑦ **Effect Utility Switch (CONNECT ... AUTO VOL)/(SUB PARAM)**
- For selecting the miscellaneous Utility functions of the GW50:
 - **CONNECT** — For determining the order of the effect blocks. (See page 45.)
 - **GROUP** — For simultaneously switching several effect blocks on/off. (See page 45.)
 - **FOOT (Foot Controller)** — For determining how the optional FC7 Foot Controller is used. (See pages 46, 47.)
 - **MIN VOL (Minimum Volume)** — For determining the minimum volume setting for the optional FC7 Foot Controller and the ASSIGNABLE Block Pedal Switch (which can be used to instantly change between minimum and maximum volume). (See page 47.)
 - **AUTO VOL (Auto Volume)** — ASSIGNABLE Block Pedal Switch can be used to gradually fade up volume at the rate set here. (See page 49.)
 - **With [SHIFT]:** For calling up Noise Gate effect parameter. (See pages 31, 69.) This also calls up the sub parameters of the Equalizer, Chorus and Reverb/Delay effects. (See page 44.)
- ⑧~⑬ **Position Control Buttons**
- ⑧~⑫ **Effect Selector Buttons**
- ⑧ **CMP/<< (SONG NAME)**
- After pressing [**SHIFT**] + [**SUB PARAM**]: Calls up Noise Gate parameter.
 - **In Connect and Group functions:** Selects Compressor effect block.
 - **In Song mode:** For moving to the top of the current or last measure. Hold down for rapid operation.
 - **In Song mode, with [v]:** For returning to the beginning of a song.
- ⑨ **DST/< (MEAS DEL)**
- After pressing [**SHIFT**] + [**SUB PARAM**]: Calls up Noise Gate parameter.
 - **In Connect and Group functions:** Selects Distortion effect block.
 - **In Song mode:** For moving backward in 16th-note steps. Hold down for rapid operation.
 - **In Song mode (with [SHIFT]):** For deleting a selected range of measures from a song.
 - **In Song mode, with [n]:** For returning to the beginning of a song.
- ⑩ **EQ/> (MEAS COPY)**
- After pressing [**SHIFT**] + [**SUB PARAM**]: Calls up Equalizer Sub parameters.
 - **In Connect and Group functions:** Selects Equalizer effect block.
 - **In Song mode:** For moving forward in 16th-note steps. Hold down for rapid operation.
 - **In Song mode, with [>>]:** For moving to the end (last recorded event) of a song.
 - **In Song mode (with [SHIFT]):** For copying a selected range of measures in a song.

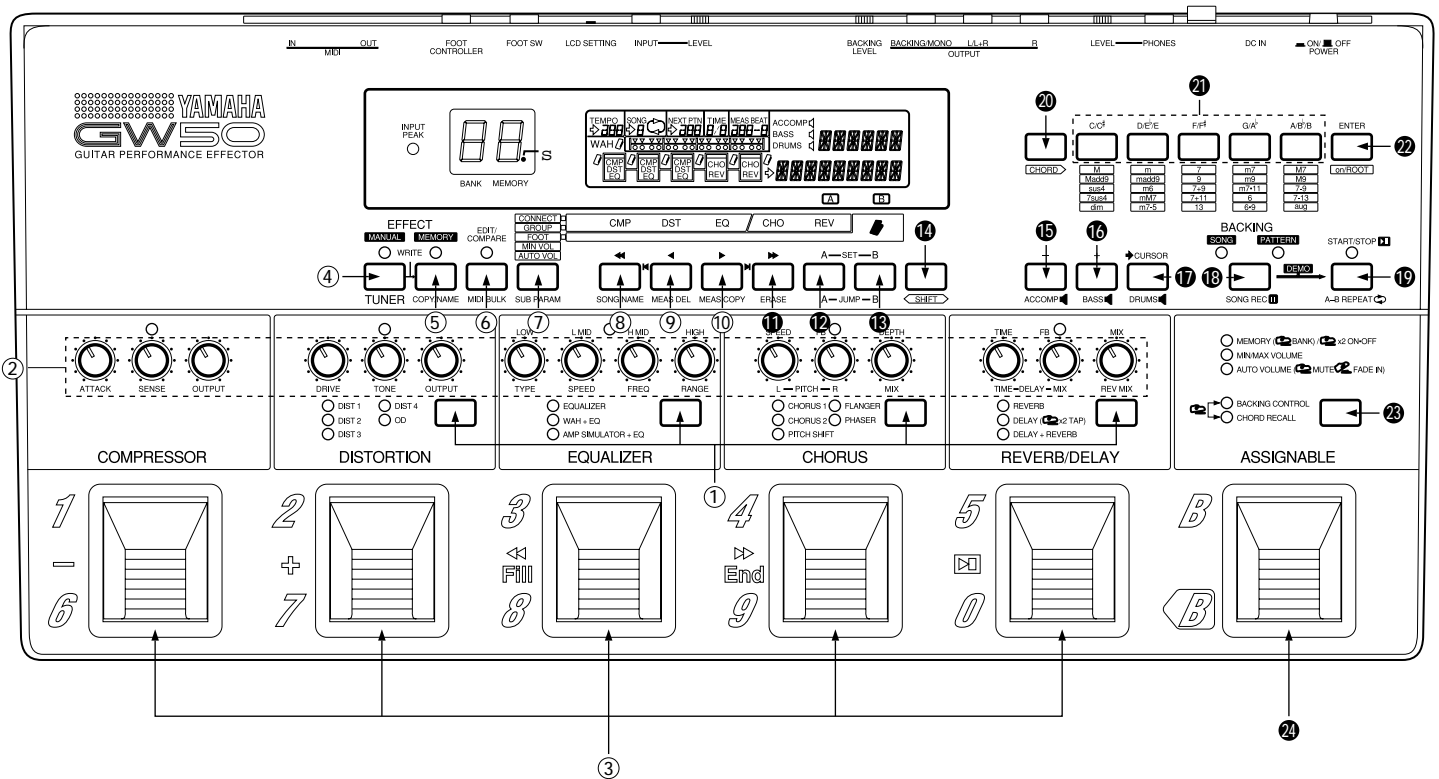

⑪ CHO/>> (ERASE)

- After pressing **[SHIFT]** + **[SUB PARAM]**: Calls up Chorus Sub parameters.
- **In Connect and Group functions**: Selects Chorus effect block.
- **In Song mode**: For moving to the top of the next measure. Hold down for rapid operation.
- **In Song mode, with [>>]**: For moving to the end (last recorded event) of a song.
- **In Song mode (with [SHIFT])**: For erasing the recorded event(s) at a specific position in a song.

⑫ REV/SET-A (JUMP-A)

- After pressing **[SHIFT]** + **[SUB PARAM]**: Calls up Reverb/Delay Sub parameters.
- **In Connect and Group functions**: Selects Reverb/Delay effect block.
- **In Song mode**: For setting the “A” mark in a song. Pressing **[SHIFT]** + **[JUMP-A]** jumps to the A-marked measure.

⑬ Foot Controller/SET-B (JUMP-B)

- **In the Foot (Foot Controller) function**: For determining how the connected foot controller is used. (See page 46.)
- **In Song mode**: For setting the “B” mark in a song. Pressing **[SHIFT]** + **[JUMP-B]** jumps to the B-marked measure.

⑭ SHIFT

- For selecting the shifted-state functions, indicated by the names printed below the appropriate buttons. Hold down this button and simultaneously press the appropriate button. (The arrow marks printed with the button name indicate the direction in which the appropriate buttons can be found.)

⑮ – (ACCOMP)

- For decreasing a selected parameter value (as described for the modes below). Hold down for rapid operation.

- In Song/Pattern mode:** For decreasing the value at the cursor position (for example, Tempo or Pattern).
- In Memory mode:** For moving backward through the effect programs, one by one (when the cursor arrow is not shown in the display).
- In Manual and Memory Edit mode (sub parameters, MIN VOL, and AUTO VOL):** For decreasing the value of the selected sub parameter (when the cursor arrow is at the bottom of the display).
- **With [SHIFT] (in the Song/Pattern modes):** For turning the sound of the Backing Accompaniment on and off, while the song or pattern is playing.
- ①⑥ + (BASS)
- For increasing a selected parameter value (as described for the modes below). Hold down for rapid operation.
- In Song/Pattern mode:** For increasing the value at the cursor position (for example, Tempo or Pattern).
- In Memory mode:** For moving forward through the effect programs, one by one (when the cursor arrow is not shown in the display).
- In Memory Edit mode (sub parameters, MIN VOL, and AUTO VOL):** For increasing the value of the selected sub parameter (when the cursor arrow is at the bottom of the display).
- **With [SHIFT] (in the Song/Pattern modes):** For turning the sound of the Backing Bass on and off, while the song or pattern is playing.
- ①⑦ 6 CURSOR (DRUMS)
- **In Song/Pattern modes:** For moving the cursor arrow in the display.
 - **With [SHIFT] (in Song/Pattern modes):** For turning the sound of the Backing Drums on and off, while the song or pattern is playing.
- ①⑧ SONG/PATTERN (SONG REC)
- For switching between the Song and Pattern modes. The LED of the selected function lights.
 - **With [SHIFT]:** For enabling realtime recording of a song (the LED flashes to indicate record standby). (See pages 37, 84.)
- ①⑨ START/STOP (A-B REPEAT ↻)
- For starting/stopping the Backing Song or Pattern (the LED flashes).
 - **With [SHIFT]:** For enabling the Repeat function. (See pages 92, 93.)
- ②⑩ CHORD
- Similar to [SHIFT], for selecting the secondary (lower) functions of the Chord buttons. The arrow mark pointing right (printed with the button name) indicates the direction in which the appropriate buttons can be found. (For details on this and other chord-related functions, refer to pages 74-76.)
- ②⑪ Chord Buttons
- For selecting the chord root note, or (after pressing [CHORD] + [on/ROOT]) for selecting the bass note.
 - **With [CHORD]:** For selecting the chord type.
- ②⑫ ENTER (on/ROOT)
- In Song mode (step recording): For recording or entering event data to a song.
 - **With [CHORD]:** For enabling selection of the bass note.

LCD Display

① **INPUT PEAK indicator** — for monitoring the input signal level (lights continuously when level is too high).

② **BANK/MEMORY indicator** — displays the memory bank and program numbers. When selecting songs, this briefly displays the song number. In the Tuner function, this displays the string number (when an open string is played) and/or the name of the note played (for example, 6E).

③ **Sharp indicator** — This flashes when a sharp note (for example, G[#] or C[#]) is played in the tuner function.

④ 6 — This cursor arrow points to a value in the display that can currently be changed by using the [-]/[+] buttons.

When **[MANUAL]** or **[MEMORY]** are pressed (calling up the Effect mode display), the arrow automatically disappears from the display. You can use [6] **CURSOR** to move the cursor arrow back “in” the display. When **[SONG/PATTERN]** is pressed (calling up the Backing mode display), the cursor automatically appears in the display.

Note: Other display indications are explained later in the relevant sections of the manual.

ASSIGNABLE Block Controls

23 ASSIGNABLE Block Type Switch

- For selecting various control functions for the ASSIGNABLE Block Pedal Switch and the other Pedal Switches including effect program selection, turning individual effect blocks (or groups) on and off, MIN/MAX Volume, Auto Volume, Backing Control and Chord Recall.

24 ASSIGNABLE Block Pedal Switch

- For performing various control functions, including effect program selection, turning individual effect blocks (or groups) on and off, MIN/MAX Volume, Auto Volume, Backing Control and Chord Recall. (The arrow mark printed with the button name at the bottom left indicates the direction in which the appropriate buttons can be found.)

For more information on the ASSIGNABLE Block Pedal Switch and the other Pedal Switches, see the section “ASSIGNABLE BLOCK AND PEDAL SWITCH FUNCTIONS” on pages 10-14.

ASSIGNABLE BLOCK AND PEDAL SWITCH FUNCTIONS

ABOUT THE ASSIGNABLE BLOCK LED INDICATORS

LED status
 ● : Lit
 ☼ : Flashing
 ○ : Off

The following illustration shows how and under what conditions the ASSIGNABLE block LEDs are lit.

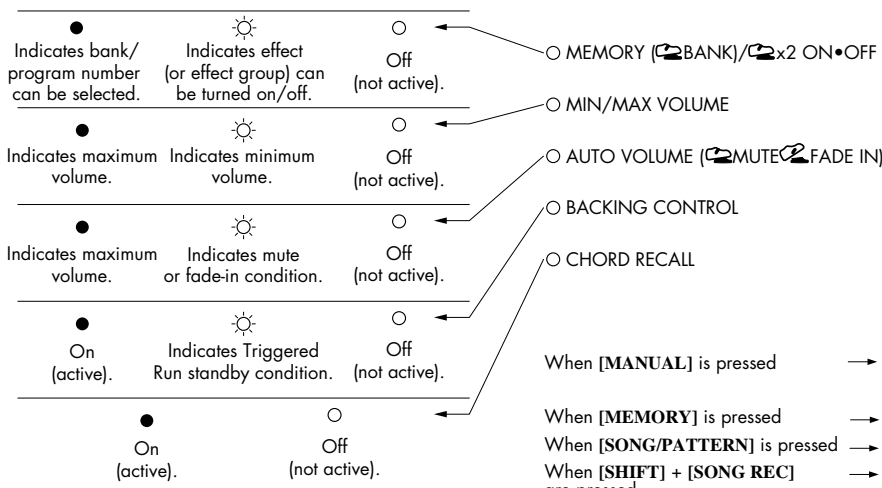

Note: The MEMORY LED above will still be lit or flashing, even if either of these is on.

ABOUT THE PEDAL SWITCHES

The Pedal Switches have many different functions, depending on the ASSIGNABLE block settings (indicated by the LEDs in the ASSIGNABLE block) and the selected mode. The following panel illustrations and explanations should help you in understanding how the Pedal Switches are used.

In the Manual, Memory* and Memory Edit modes:

When switching on/off individual effect blocks (or Groups) is enabled —

* Available in Memory mode only when ASSIGNABLE Block Pedal Switch has been pressed twice quickly (enabling effect on/off control).

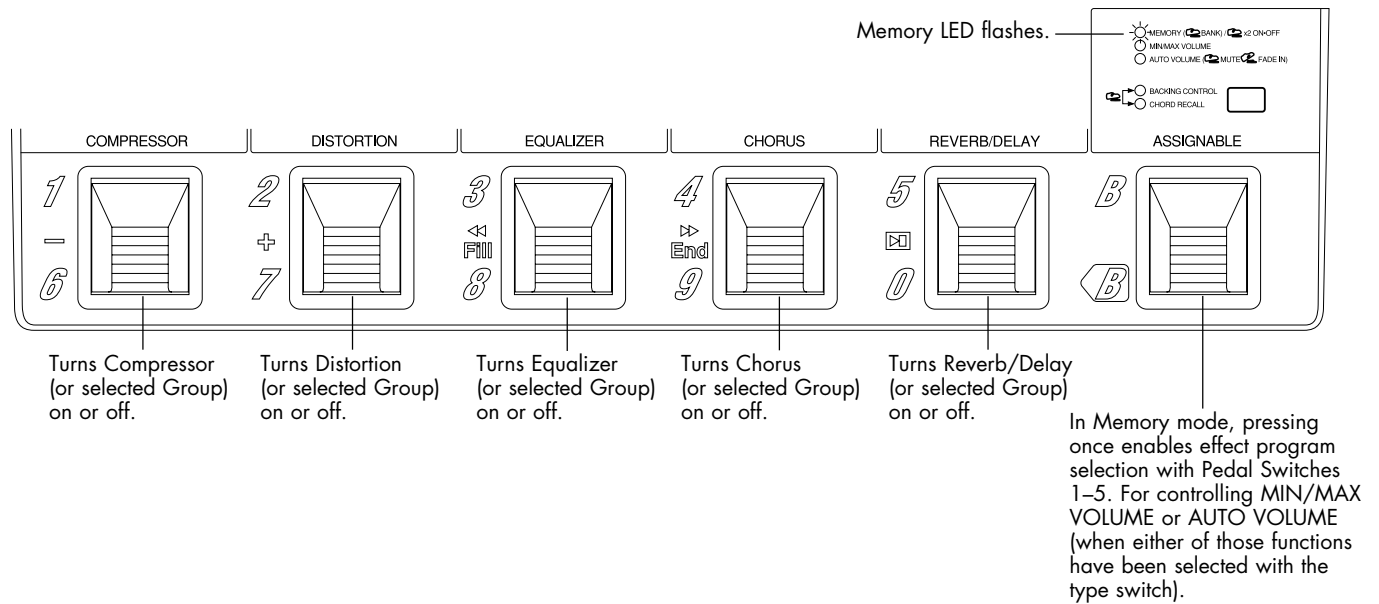

In the Memory mode:

When selection of effect bank number/program number is enabled —

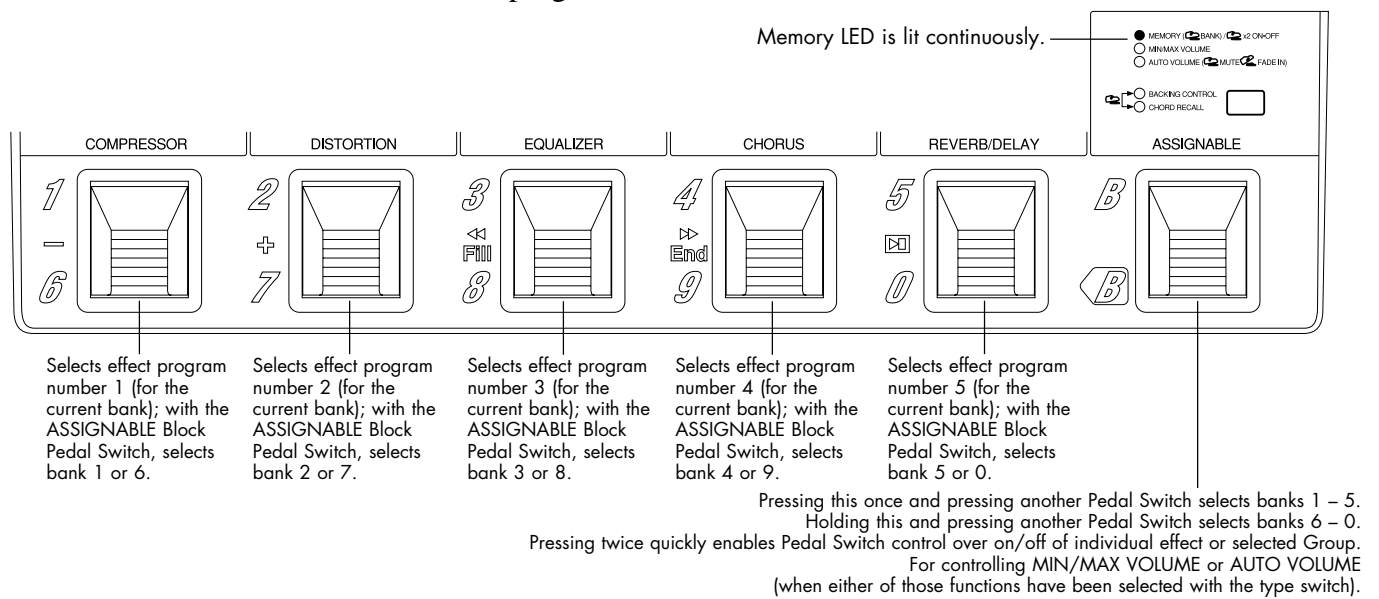

In the Pattern mode:
 With BACKING CONTROL selected —
 When pattern is stopped:

Decreases pattern number by 2 (every other odd numbered pattern).

Increases pattern number by 2 (every other odd numbered pattern).

Starts pattern playback.

Pressing once selects CHORD RECALL; holding this and pressing one of Pedal Switches 1 – 4 assigns current chord to the pressed Pedal Switch. Holding this enables the Root Select function (see page 78).

When pattern is playing back:

Decreases pattern number by 2 (every other odd numbered pattern).

Increases pattern number by 2 (every other odd numbered pattern).

Plays fill in pattern.

Plays ending pattern (then stops playback).

Stops pattern playback.

Pressing once selects CHORD RECALL; holding this and pressing one of Pedal Switches 1 – 4 assigns current chord to the pressed Pedal Switch. Holding this enables the Root Select function (see page 78).

In the Pattern mode:
 With CHORD RECALL selected —

Plays chord 1 (with ASSIGNABLE Pedal Switch; assigns chord 1).

Plays chord 2 (with ASSIGNABLE Pedal Switch; assigns chord 2).

Plays chord 3 (with ASSIGNABLE Pedal Switch; assigns chord 3).

Plays chord 4 (with ASSIGNABLE Pedal Switch; assigns chord 4).

Starts/stops pattern playback.

Pressing once selects BACKING CONTROL; holding this and pressing one of Pedal Switches 1 – 4 assigns current chord to the pressed Pedal Switch. Holding this enables the Root Select function (see page 78).

In the Song mode (playback):
 With BACKING CONTROL selected —
 When song is stopped:

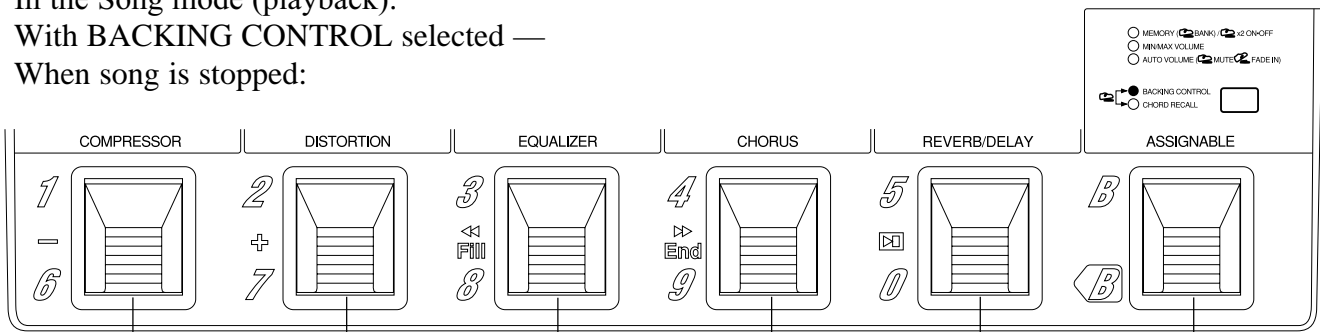

Decreases song number by 1. Increases song number by 1. Moves to previous measure. Moves to next measure. Starts song playback.

Holding this and pressing Pedal Switch 5 enables Triggered Run function (see page 82).

When song is playing back:

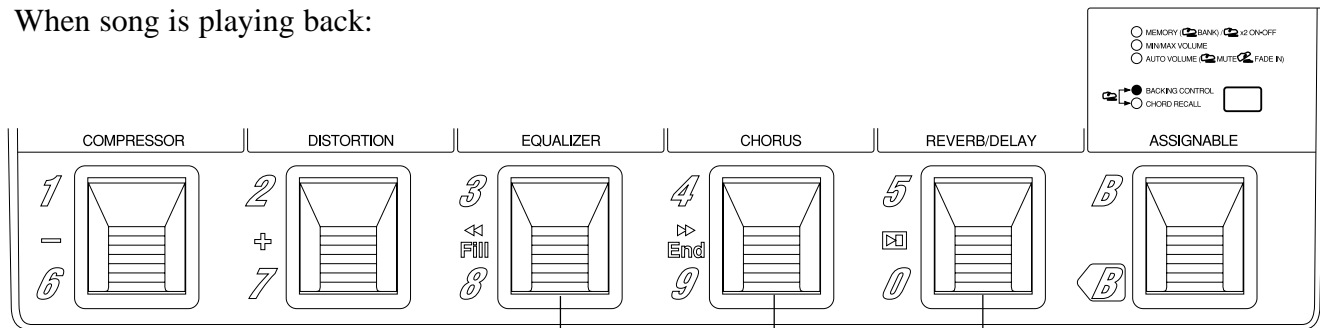

Moves to beginning of current measure. Moves to next measure. Stops song playback.

In the Song Realtime Recording mode:
 With CHORD RECALL selected —

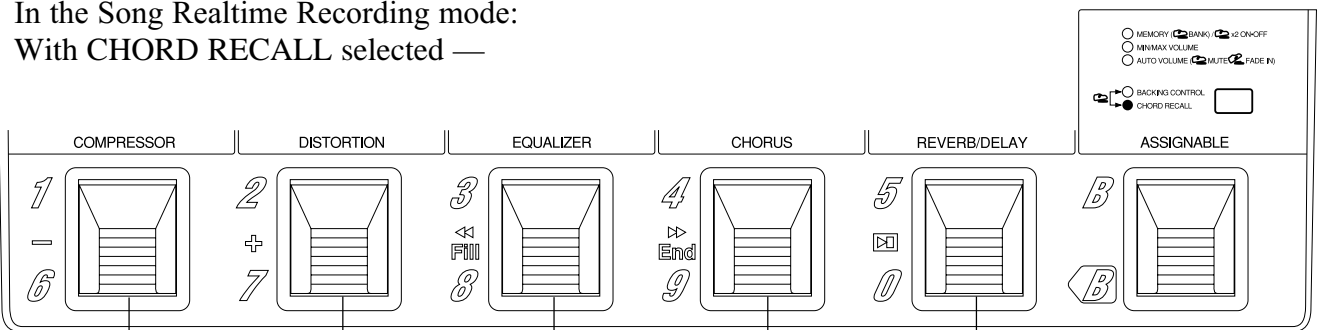

Plays chord 1. Plays chord 2. Plays chord 3. Plays chord 4. Starts/stops song recording.

* The following chart shows which ASSIGNABLE Block functions are available in which modes. Also refer to the section “ASSIGNABLE BLOCK AND PEDAL SWITCH FUNCTIONS CHART” on page 128.

ASSIGNABLE Block function	Manual	Memory	Memory Edit	Pattern	Song	Song Realtime Recording
MEMORY: BANK/NUMBER select	×	○ or	×	—	—	—
MEMORY: ON/OFF	○	○	○	—	—	—
MIN/MAX VOLUME	○	○	○	—	—	—
AUTO VOLUME	○	○	○	—	—	—
BACKING CONTROL	—	—	—	○	○	×
CHORD RECALL	—	—	—	○	×	○

- : Available
- × : Not available
- : Not relevant (to this mode)

Shaded sections indicate settings that are automatically selected when the corresponding mode buttons are pressed.

REAR PANEL

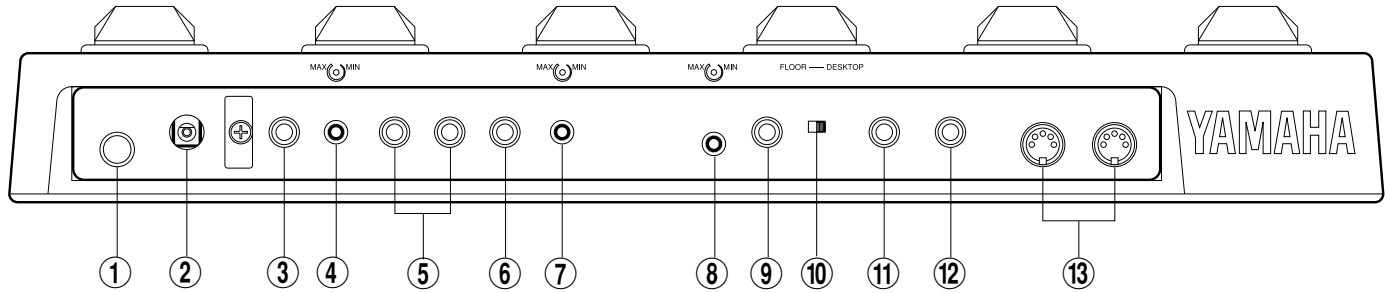

① POWER ON/OFF Switch

② DC IN Terminal

For connection to the supplied PA-3 AC adaptor.

The cable clip located next to this terminal helps to prevent accidental unplugging of the power supply during use. Wrap the adaptor cord firmly around the clip (as shown at right).

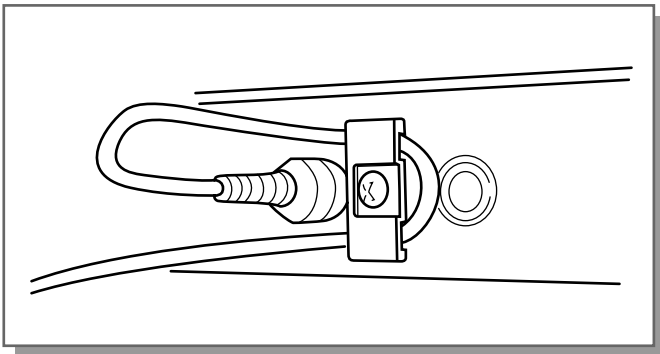

③ PHONES Jack

For output of both the Backing sound (mono) and the instrument/effect sound (stereo) to a set of stereo headphones.

④ Headphone LEVEL Control

For adjusting only the headphone output; this does not affect the output of the other output jacks.

⑤ L/L+R OUTPUT and R OUTPUT Jacks

For stereo or mono output of the instrument/effect sound. Connect both of these to the corresponding left and right channels of your stereo amplification system to take full advantage of the stereo effects of the GW50. For mono operation, connect your system to the L/L+R jack; this provides a mono mix of the instrument/effect sound.

⑥ BACKING/MONO OUTPUT Jack

When only this output jack is connected, this outputs a mono mix of the Backing Accompaniment, Bass and Drums sound, plus the input instrument/effect sound. When the other output(s) are also connected, only the Backing sound is output from this jack.

⑦ BACKING LEVEL Control

For adjusting the level of the Backing Accompaniment, Bass and Drums output.

⑧ Input LEVEL Control

For adjusting the level of the input signal.

⑨ INPUT Jack

For connection of an instrument (guitar, bass, etc.). (See pages 19, 20 for more information on input/output connections.)

⑩ LCD SETTING Switch

Two-position (Floor/Desktop) switch for setting the display contrast for optimum viewing.

⑪ FOOT SW Jack

For connection of an optional footswitch (Yamaha FC5 or FC4), for controlling certain functions and parameters as you play. (See pages 56, 57.)

⑫ FOOT CONTROLLER Jack

For connection of an optional foot controller (Yamaha FC7), for controlling certain functions and parameters as you play. (See page 46.)

⑬ MIDI IN/OUT Terminals

For connection of MIDI cables, when using the GW50 with other MIDI devices. (See page 101.)



GW50

GUIDED TOUR (TUTORIAL) — SETTING UP, PLAYING AND USING YOUR GW50

SETTING UP AND PLAYING YOUR GW50	19
DEMO MODE — PLAYING THE DEMONSTRATION SONGS	22
EFFECT SECTION	24
PLAYING WITH SOME OF THE EFFECTS	24
CHANGING THE SOUND OF THE EFFECTS	26
CHANGING (EDITING) AN EFFECT PROGRAM AND SAVING IT	29
USING THE NOISE GATE TO GET A CLEAN SIGNAL	31
BACKING SECTION	32
PLAYING PATTERNS — PATTERN MODE	32
PLAYING AND RECORDING SONGS — SONG MODE	36
USING THE BUILT-IN TUNER	39



SETTING UP AND PLAYING YOUR GW50

Once you've taken your GW50 out of the box and are ready to use it, follow the simple instructions below in making the connections and setting it up.

1. First, make sure that the power switch on the GW50 is off before making ANY connections.
2. Plug the DC output cable from the supplied PA-3 adaptor into the DC IN terminal on the rear panel, then plug the adaptor into a convenient AC outlet.

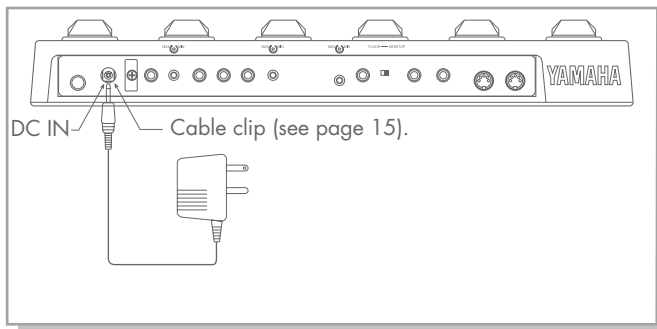

Note: Be sure to check whether the rated voltage is appropriate. The provided adaptor is intended for use in the area which you purchased the GW50. If you intend to use it in a different area, consult your Yamaha dealer for more information on voltage requirements.



Do not attempt to use a different AC adaptor with the GW50. The use of an incompatible adaptor may cause irreparable damage to the unit and pose a serious shock hazard.

3. Plug your instrument into the INPUT jack on the rear panel.

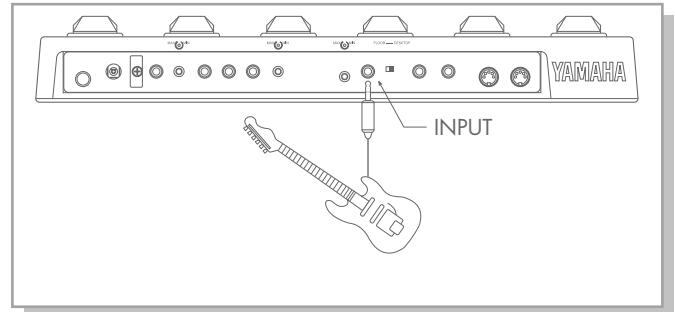

For the sake of these instructions, we'll assume you're using an electric guitar; however, most any electronic instrument can be used.

Note: You should be careful if you are connecting a synthesizer or electronic keyboard; generally their output level is much higher than that of a guitar and the input level (see step #6 below) should be turned down accordingly.



Do not connect the BACKING/MONO output jack with the INPUT jack in an attempt to use the effects of the GW50 on the Backing sound. Doing so results in feedback.

4. Connect the GW50 outputs to your amplifier/speaker system, making sure that the power on the system is first turned off.
Four example connection systems are shown below. Use the one which most closely resembles your own system.

Note: When using Distortion on the GW50, use the clean channel of the guitar amp.

Example 1 — One Input

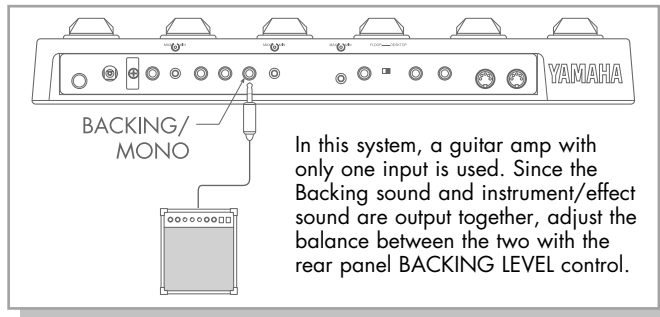

Example 2 — Two Inputs

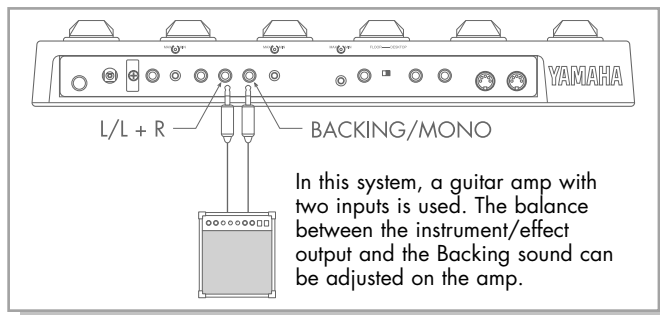

Example 3 — Guitar Amp(s) and Stereo System

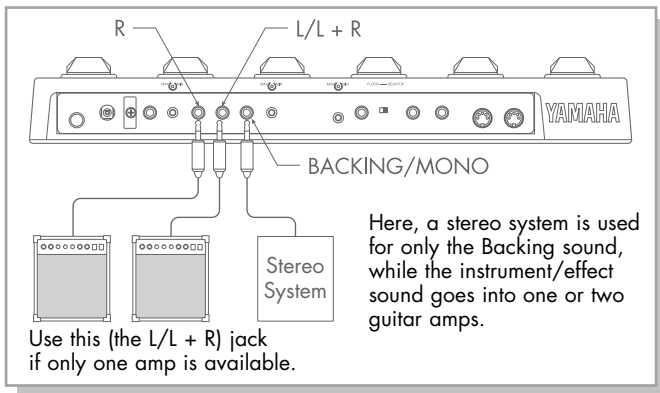

Example 4 — Mixing Console

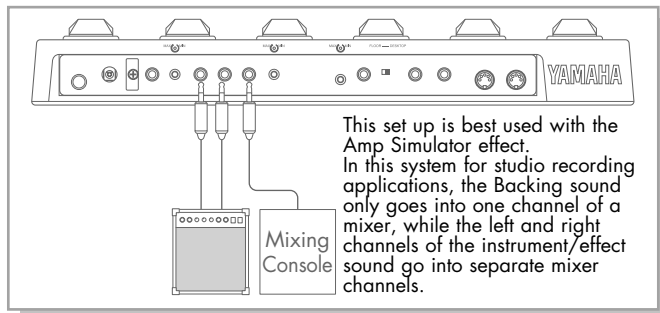

In examples 2, 3 and 4 above, only the Backing parts (rhythm, accompaniment, etc.) are output from the BACKING/MONO jack and only the instrument/effect sound is output from the L/L + R jack or the L/L + R and R jacks.

You can also listen to the GW50 through a set of headphones. Connect them to the PHONES jack on the rear panel.

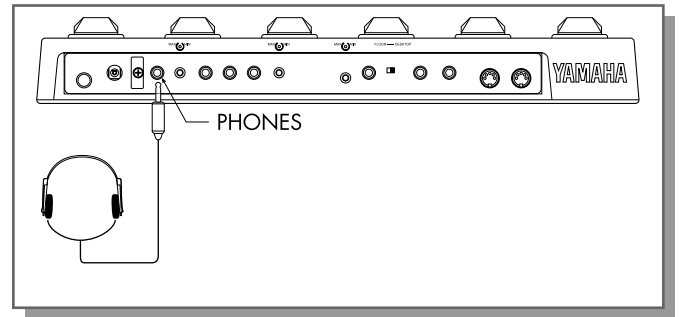

5. If you have them, connect a foot controller (the optional Yamaha FC7) to the FOOT CONTROLLER jack, and a footswitch (the optional Yamaha FC5 or FC4) to the FOOT SW jack.

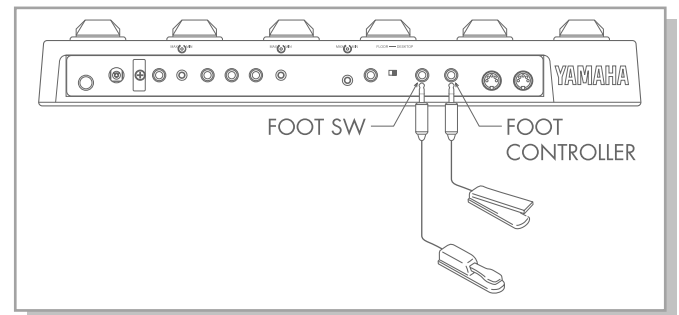

This step isn't necessary for using your GW50 for the first time; however, you may wish later to take advantage of some of the external foot controller and footswitch functions. (See pages 46, 56 for more information.)

6. Make sure that all volume settings are at the minimum: the guitar controls, the INPUT LEVEL and BACKING LEVEL on the GW50 (and the PHONES LEVEL, if you're using headphones), and the volume on the amp.

Note: To set the controls on the GW50 to minimum, turn them all the way counterclockwise.

7. Turn on the power of all the equipment, starting with the GW50, then the connected amplifier.
 - * Adjust the LCD SETTING switch on the rear panel to set the LCD for proper viewing. Set it to FLOOR when you are using the GW50 on the floor, and to DESKTOP when you have it set on a table or desk in front of you.

8. Before turning up the volume and trying to play, set all effects to off.

To do this, press [MANUAL] (even if the [MANUAL] LED is lit) ...

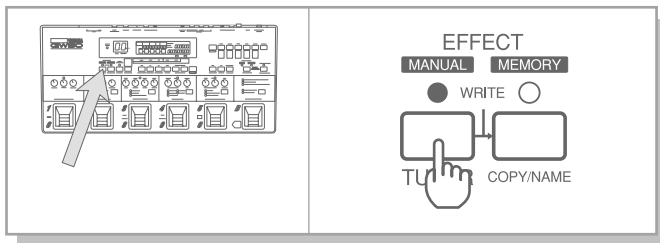

...then, if any effect block LED is lit, press Pedal Switches 1-5 to turn all effects off (all effect block LEDs should be off).

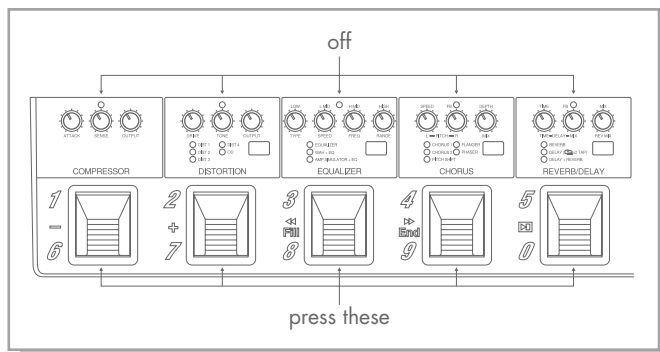

9. While playing your guitar, slowly bring up the volume controls to suitable levels — starting with the amp, then the guitar output.

Finally, adjust the input level control on the rear panel. Increase the level slowly as you play the guitar while looking at the INPUT PEAK indicator on the panel. The indicator should flash only slightly when you play the guitar at its loudest.

Also, check that the guitar sound doesn't have distortion at its loudest.

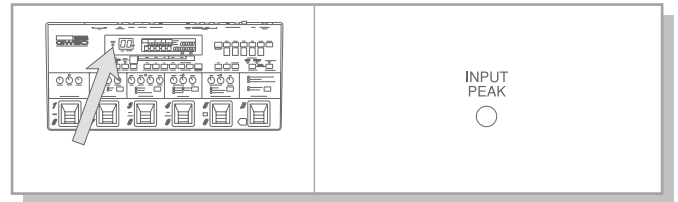

10. Do the same with the BACKING LEVEL.

First turn the backing on by pressing [START/STOP]...

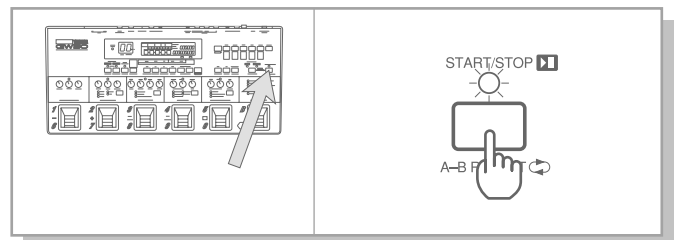

...then turn up the BACKING LEVEL to a suitable volume.

If you've followed all these instructions carefully, you should be able to hear both your guitar sound processed by the effects, and the sound of the backing parts.

Note: To stop the backing, press [START/STOP] again.

DEMO MODE — PLAYING THE DEMONSTRATION SONGS

The GW50 features a special Demo mode that showcases some of the interesting things that can be accomplished by using the Backing patterns and the song recording functions. The Song Demo plays continuously through preset songs 1 to 6, while the Pattern Demo plays various patterns in succession. Try playing along on your guitar with both of the demos, since they feature some effect program changes as well.

To use the Demo mode:

1. Simultaneously hold down [SONG/PATTERN] and press [START/STOP].

Note: The Demo mode cannot be entered from the Memory Edit modes (EDIT/COMPARE LED is lit or flashes). In this case, exit the Memory Edit modes (see pages 30, 53).

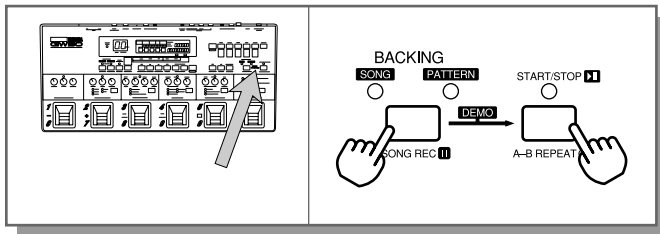

(You can abort or exit the Demo mode at this stage by pressing any of the mode buttons.)

2. Select the Song Demo by pressing [SET-A] (below “SONG” in the display), or the Pattern Demo by pressing [SET-B] (below “PTN” in the display).

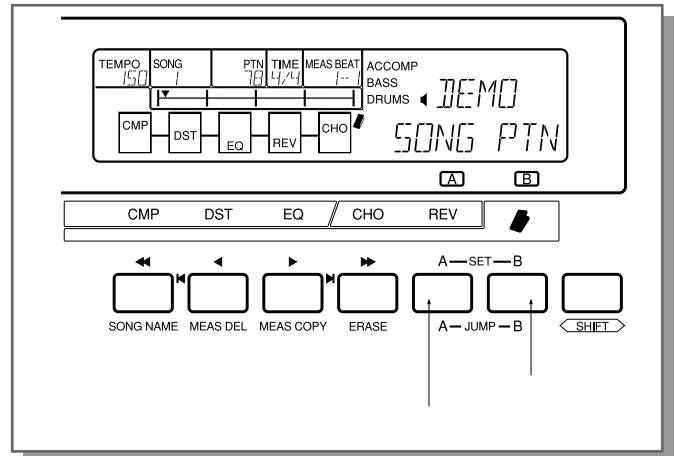

The Song or Pattern Demo begins playing once you press the appropriate button. (The [START/STOP] LED flashes.)

3. While the Song Demo or Pattern Demo is playing back, try playing your guitar along with the song or pattern.

You’ll notice that some effect program changes have been recorded to the Demo, automatically changing the sound as you play.

If you’ve selected the Pattern Demo, you can change chords as it plays by pressing Pedal Switches 1 – 4. The following chords have been assigned to the Pedal Switches:

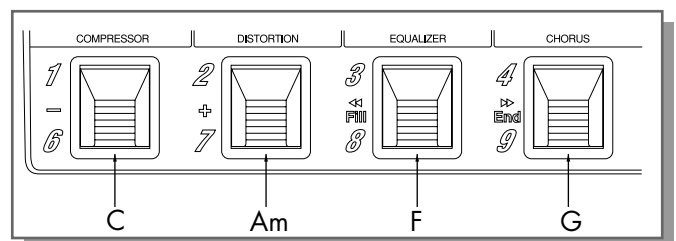

- 4.** To stop the Demo, press [SET-B] (below “STOP” in the display) or [START/STOP] (or any of the mode buttons).

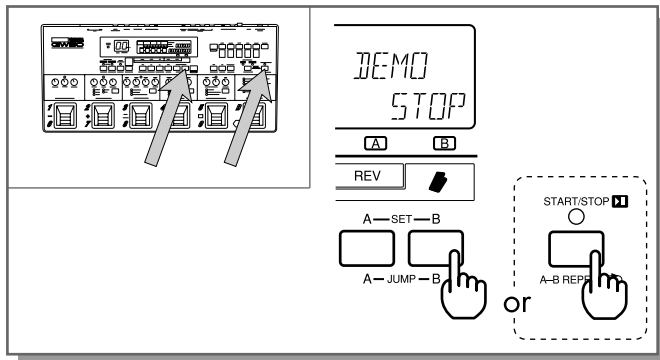

Note: All the songs or patterns play in succession indefinitely until stopped.

Note: While the Demo mode is called up, other functions are not active.

EFFECT SECTION

The GW50 is equipped with a comprehensive set of effects designed specifically for the guitar player. As you'll see below, the GW50 lets you switch these effects on and off as needed and adjust them quickly and easily from the panel controls and Pedal Switches.

The effects are divided into five groups or blocks, and they include the following specific effects:

Compressor	Compressor
Distortion	Distortion 1, 2, 3, 4, and Overdrive
Equalizer	Four-band Parametric EQ, Wah + Two-band EQ, and Amp Simulator + Two-band EQ
Chorus	Chorus 1, 2, Pitch Shifter, Flanger, and Phaser
Reverb/Delay	Reverb, Delay, and Delay + Reverb,

(Refer to the "EFFECTS AND PARAMETERS" section, page 58, for more detailed descriptions and explanations of these effects.)

A programmable Noise Gate is also included for filtering out hum, hiss and other undesirable noise when the signal is low. (See pages 31, 69.)

PLAYING WITH SOME OF THE EFFECTS

Now that you've got sound out of the GW50 and have heard some of the Demo Songs, let's try playing with some of the effects.

1. Press **[MEMORY]**, even if the MEMORY LED is lit.

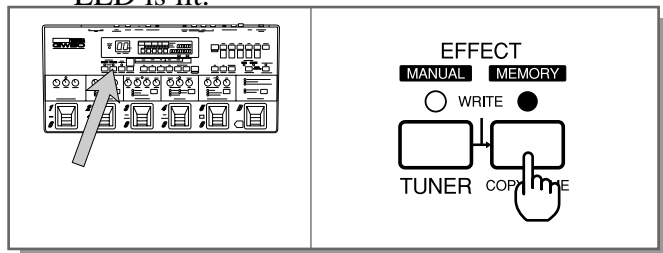

2. First, try playing with a clean chorus and delay effect. Use the **[-]/[+]** buttons to select program number 25. (The **[-]/[+]** buttons also feature rapid operation; see page 5.)

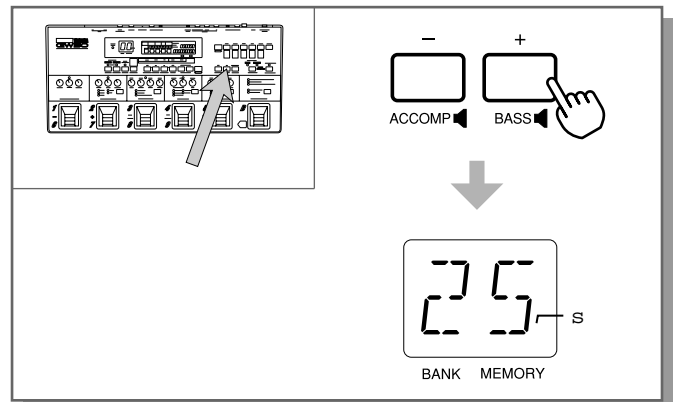

- 3.** Now, try a heavy distortion sound. Use the [-]/[+] buttons again, this time selecting program number 74.

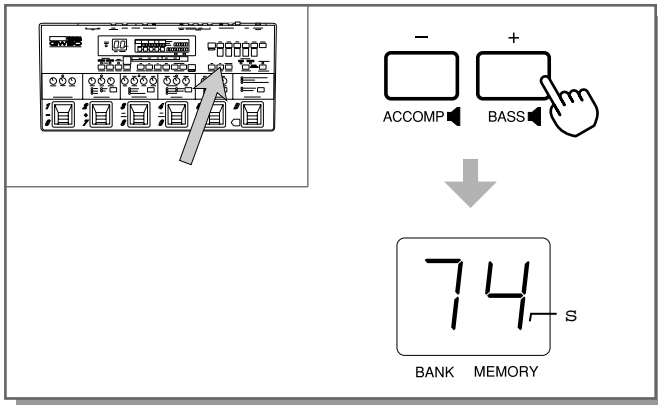

- 4.** Next, let's call up a classic rock'n'roll delay effect. This time though, use the Pedal Switches to select the program. (If the MEMORY LED in the ASSIGNABLE Block is flashing, press the ASSIGNABLE Block Pedal Switch to make it light continuously.) Press Pedal Switch 1. This selects program number 71.

Notice that the program numbers all have two digits. The first number is actually the bank number. The 50 programs are divided into 10 banks of five programs each. In the last step, you just selected the 1st program of the 7th bank.

- 5.** To select both a bank number and program number with the Pedal Switches, press the ASSIGNABLE Block Pedal Switch once.

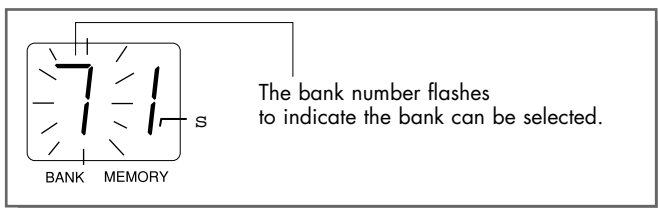

- 6.** Press the Pedal Switch corresponding to the bank you wish to select, 1 – 5 (printed at the top left of each Pedal Switch).

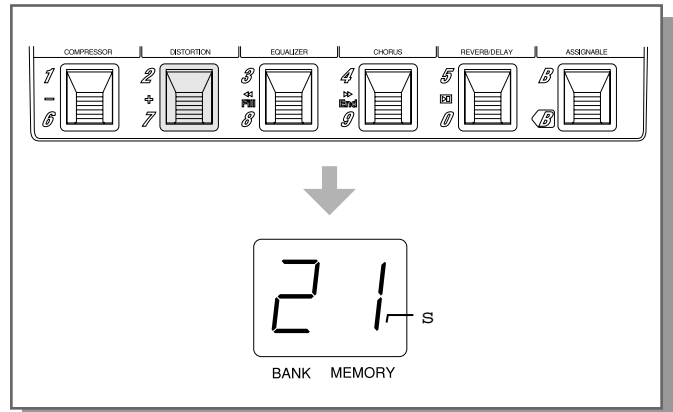

To select one of the banks 6 – 0, simultaneously press and hold down the ASSIGNABLE Block Pedal Switch, and press the corresponding Pedal Switch, 6 – 0 (printed at the bottom left of each Pedal Switch).

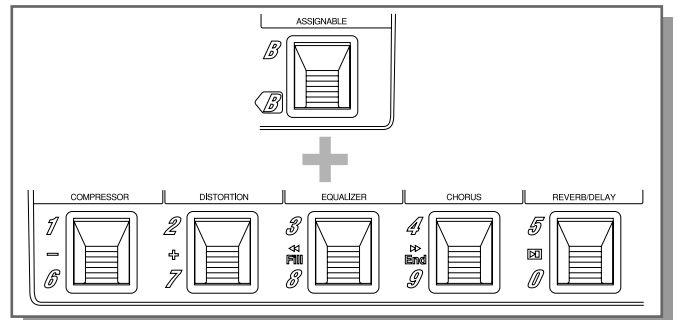

- 7.** Finally, select one of the five programs in the bank (as you did in step #4 above).

- 8.** Now, go on to explore some of the other effect programs, selecting them either with the [-]/[+] buttons or the Pedal Switches. Look through the Preset Effect Program list on page 132 for more information about the programs, and play with a few of them to hear how they sound.

CHANGING THE SOUND OF THE EFFECTS

The effect section of the GW50 has three basic modes: Manual, Memory and Memory Edit. In this section we'll use the Manual mode, since it provides a convenient starting point for adjusting and creating effects.

1. To select the Manual mode, press [MANUAL].

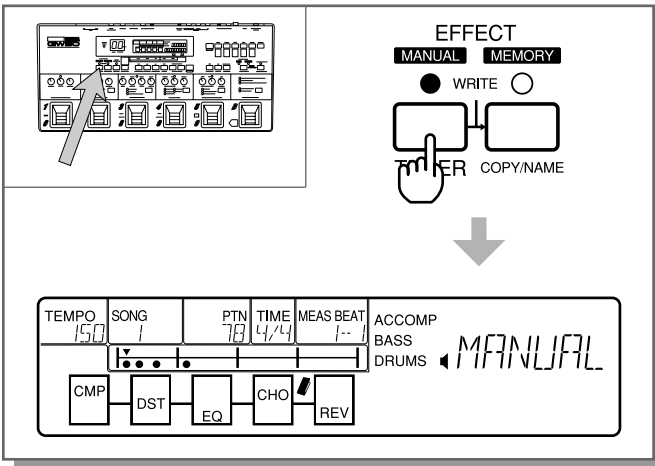

2. Make sure that each effect block is set to its first effect, as shown below. If it isn't, press the effect type switch until the LED next to the appropriate effect is lit. (For example, the DIST 1 LED should be lit in the Distortion block.)

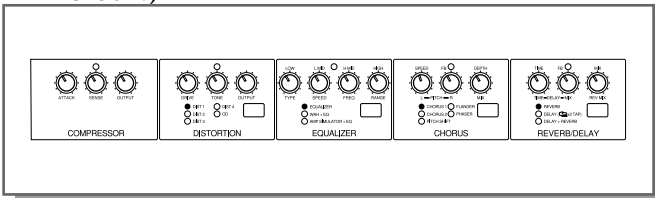

3. To start out, set the parameter knobs of the effect blocks roughly to the positions shown below. (The approximate suggested values of the parameters are also given.)

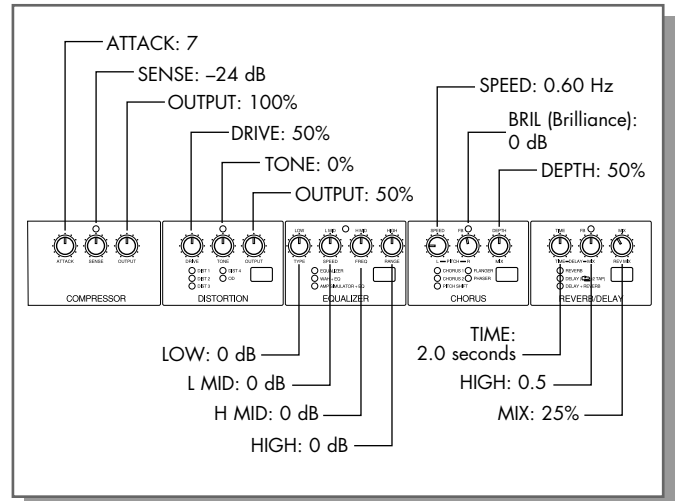

4. Next, use the Pedal Switches to turn on only the Chorus block. For example, if the Compressor is on (its red LED will be lit), press the Pedal Switch in the block to turn it off; if the Chorus is off (its LED will be off), press the Pedal Switch in the block to turn it on.

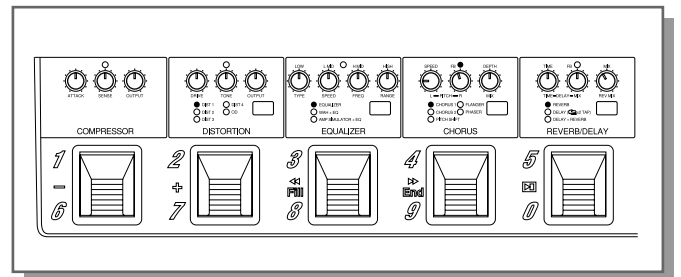

Note: The settings you've made in steps #2, #3 and #4 above are only arbitrary; they make it possible for you to use and hear all of the effect blocks. (However, the Equalizer effect is "flat" for these settings, and cannot be heard unless you adjust them.)

- 5.** Try playing your guitar now, and as you play, adjust the **SPEED** control in the **CHORUS** block and listen to how the sound changes.

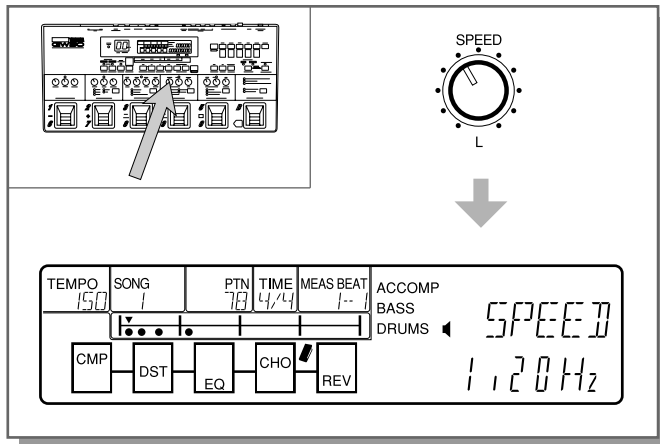

The Speed parameter is shown in the LCD, along with the value. Notice how the value changes as you turn the knob.

Do the same with the other controls in the CHORUS block, too. In fact, go on and try out the other effects as well, first by turning them on with the respective Pedal Switches, then adjusting their parameter knobs.

In the Manual mode, all the effect controls are “live” or active — you can change the effect settings directly from the panel knobs as you would with a normal pedal effect box. Moreover, the values are displayed instantly as you change them.

- 6.** As you’ve seen, you can also turn individual effect blocks on or off by simply pressing the Pedal Switch of the appropriate block. For example, to turn off CHORUS here, press the CHORUS Pedal Switch. (Note: This only works for individual effects that have not been assigned to a Group; see page 45 for details.)

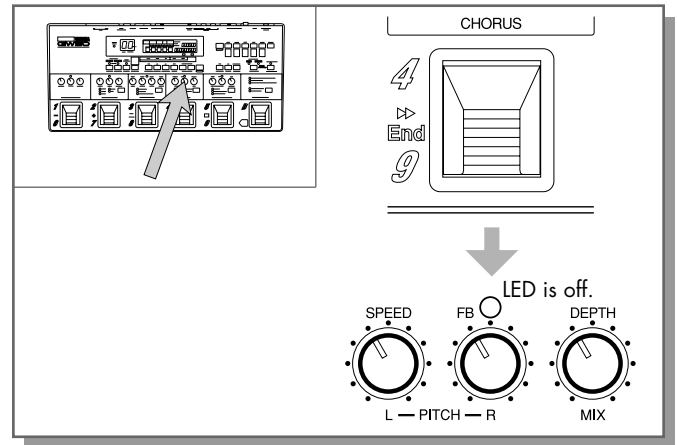

Notice that the red LED at the top of the block is now off, indicating that the effect is off. Press the CHORUS Pedal Switch again to turn the effect and the LED back on.

Although we’re using the Pedal Switches to turn a single effect block on and off, it is possible to “group” together several effect blocks to be turned on and off from just one Pedal Switch. For more information on how to use this function, see page 45.

- 7.** Take a look now at the LCD again. Notice the chain of five boxes at the bottom left. These represent the effect blocks.

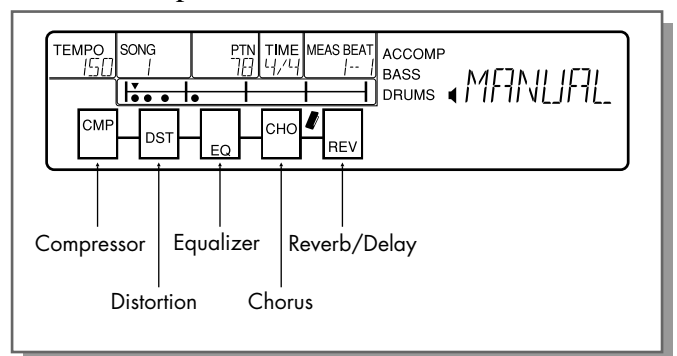

This shows the current order of the effects in the chain, from left to right. Remember that you can change this order. To do this, press the Utility switch until “CONNECT” is shown in the LCD.

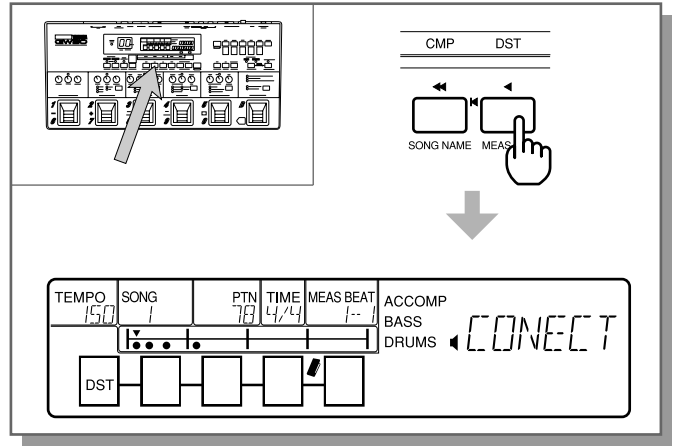
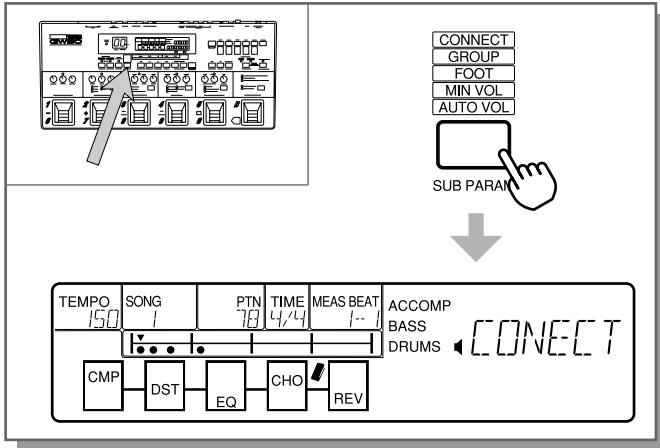

8. Use the five switches just below the LCD (labeled CMP, DST, EQ, CHO and REV) to select the order of the corresponding effects.

Note: Compressor, Distortion and Equalizer can only be selected for the first three effects, while Chorus and Reverb/Delay are always the last two.

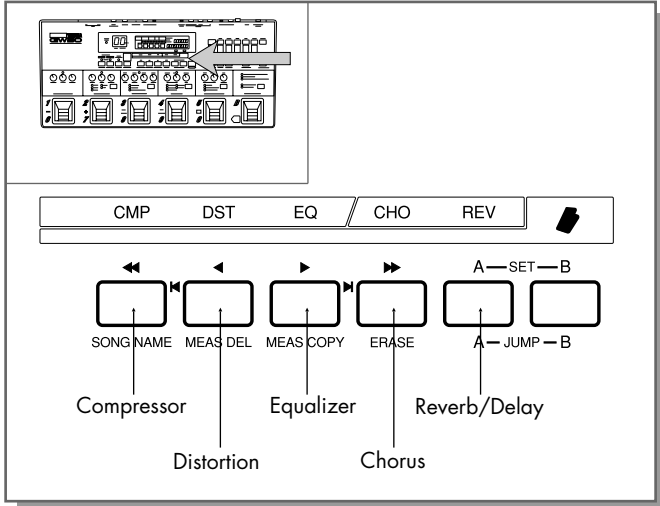
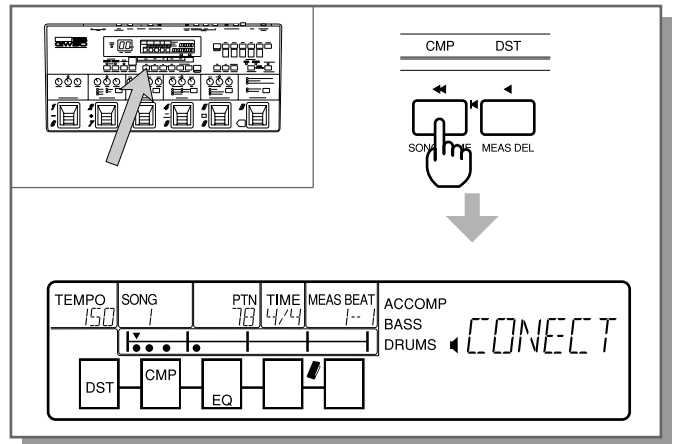

Next, press [CMP] to select Compressor for the second effect.

Equalizer (EQ) is automatically selected for the third effect, since the last two are reserved for Chorus and Reverb/Delay.

Finally, select the fourth effect in the chain. Press [CHO].

For example, to put the Distortion first in the chain, press [DST].

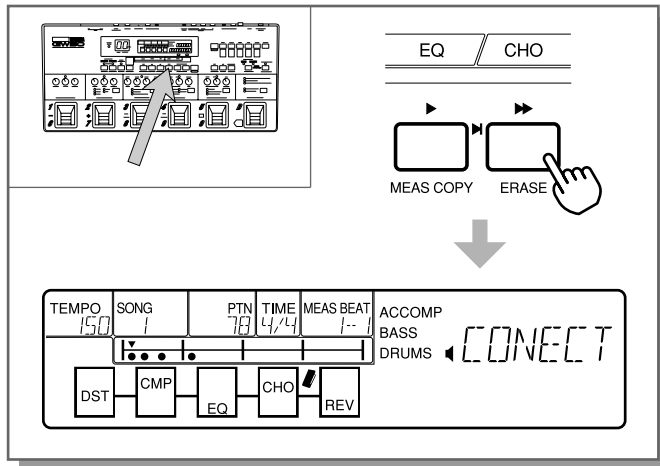

Like with Equalizer above, Reverb/Delay is selected automatically for the fifth effect after you've selected Chorus for the fourth.

CHANGING (EDITING) AN EFFECT PROGRAM AND SAVING IT

In this section, you'll learn how to take an existing effect program in the Memory mode and "tweak" it, or change its sound. You'll also learn how to compare it with the original program. Finally, you'll learn how to recall that original program or save your newly created one.

1. Press [MEMORY], (even if the MEMORY is lit) then select program number 25. Use the [-]/[+] buttons or the Pedal Switches.
2. Press [EDIT/COMPARE]. This calls up the Memory Edit mode.

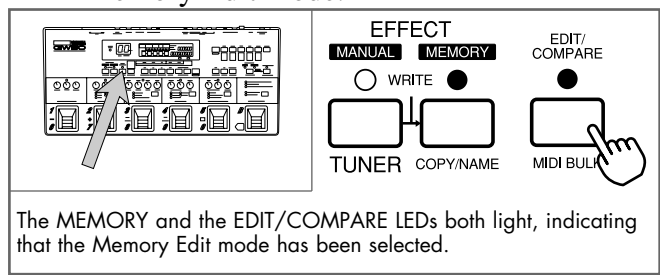

3. Now, try changing the settings of the effect blocks, as you did in the Manual mode above.
4. You can compare the sound of the newly edited program with the sound of the original one by pressing [EDIT/COMPARE] again.

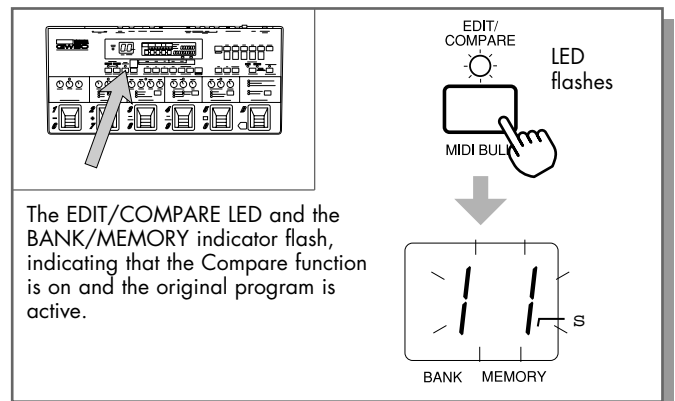

In this condition, you can hear the sound of the original effect program. You can also view the old parameter values by turning the panel knobs. Doing this doesn't change the value, it simply displays it so that you can check it against the value you've edited.

Switch between the original program and your newly edited as often as you like by pressing [EDIT/COMPARE].

- 5.** You have two choices here:
- 1) you can recall the original program (and erase your changes), or
 - 2) you can store your changes to the current program number (and erase the original one).
- 1) If you happen to like the sound of the original effect program better than your changes, press [MANUAL] or [MEMORY] while the EDIT/COMPARE LED is flashing (Compare condition). This recalls the original program.

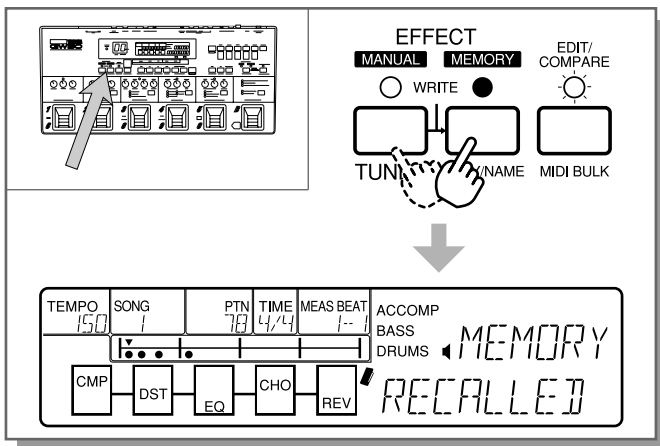

- 2) If you want to save your newly edited program (and don't mind erasing the original one), press [MANUAL] or [MEMORY] while the EDIT/COMPARE LED is lit continuously (Edit condition).

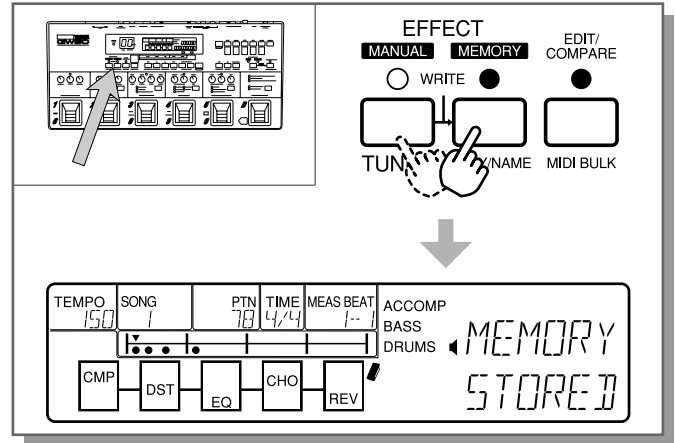

AVOID LOSING IMPORTANT DATA—After you've made some edits using the steps above, be careful NOT to press [MANUAL] or [MEMORY] unless you are absolutely sure that you want to either recall the original program or save the new one. Be careful also to check which condition is active — Edit (with the continuously lit LED) or Compare (with the flashing LED). If you mistakenly press [MANUAL] or [MEMORY] in either condition, you may irretrievably lose important data!

Note: Regarding the above caution, there are certain precautions you can take to avoid losing important programs, such as backing up your original ones with the MIDI Bulk Transmission function (see page 102), and restoring factory preset programs (see page 57) if you've erased them.



TROUBLESHOOTING SOUND PROBLEMS—Keep in mind that the sound of one effect depends on the effects that are placed before it in the chain. If while creating an effect program, you don't get any sound or the sound is not what you expected it to be, try listening to each effect block alone in order to isolate the "problem" effect. Usually the trouble is in the input or output settings of an effect (see notes on pages 58, 59, 63 and 66 for more information). If the input or output is too low, you may get too soft a sound or no sound at all; if the input or output is too high, you may get a signal that is overloading subsequent effects.

USING THE NOISE GATE TO GET A CLEAN SIGNAL

Since all its effects are connected internally, the GW50 generates no noise of its own. However, since the guitar and connecting cord you use may not be as quiet as the GW50, a built-in Noise Gate has been included to filter out any unwanted noise or hum and keep the signal completely quiet when you're not playing. (For more information on the Noise Gate, see page 69.)

To select and adjust the noise gate:

- From Manual or Memory Edit mode, simultaneously hold down [SHIFT] and press [SUB PARAM] until "N.GATE" is shown in the LCD.

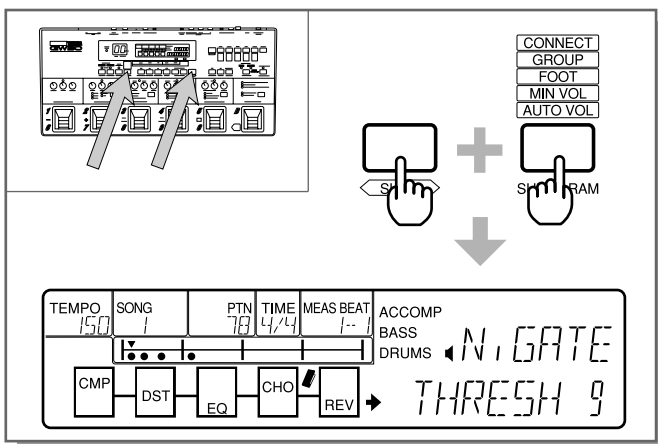

- Adjust the Threshold (THRESH) value in the display, using the [-]/[+] buttons.

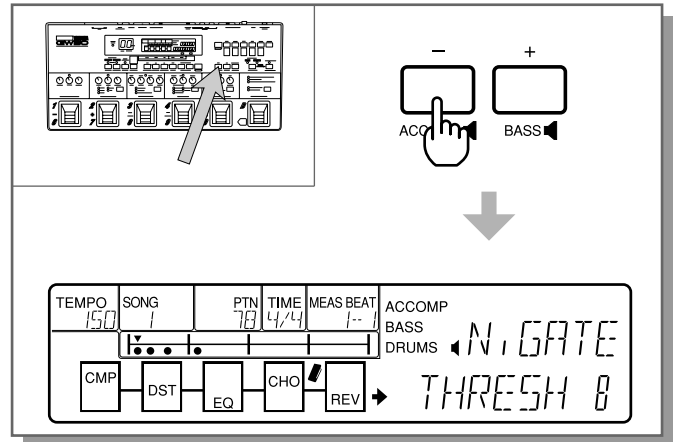

Set this to a high value when the noise level is particularly high.

BACKING SECTION

The Backing section of the GW50 is divided into two modes: Pattern and Song.

PLAYING PATTERNS — PATTERN MODE

The Pattern mode lets you play various rhythm and accompaniment patterns in a wide variety of styles. The patterns feature dynamic and realistic drum, bass and other accompaniment sounds, such as piano, guitar and organ. What's more, the sophisticated accompaniment and bass sounds can be changed to any key and automatically re-harmonized in 25 different chord types. With this kind of control, you've got a complete backing band to accompany you as you practice, play or perform.

1. Press [SONG/PATTERN] until the PATTERN LED lights (even if the LED is already lit). This selects the Pattern mode.

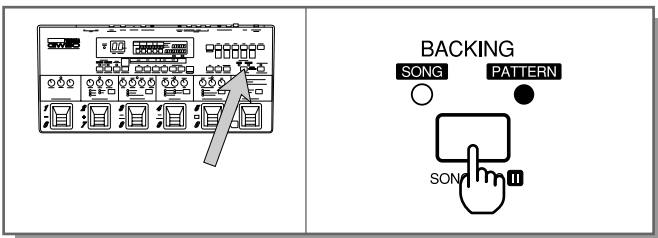

2. Using [6 CURSOR], move the arrow in the display to the PTN (Pattern) box.

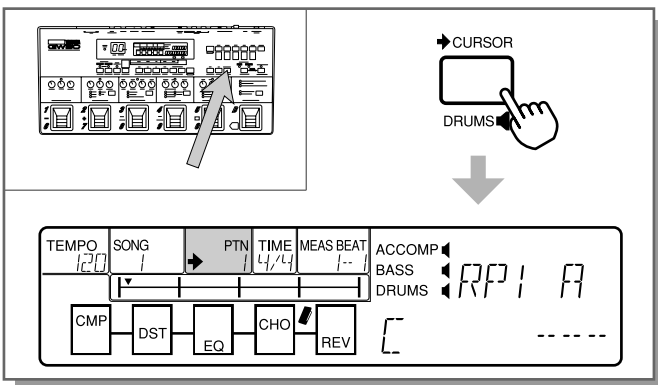

3. Now, you can use the [-]/[+] buttons to select a pattern number. (The [-]/[+] buttons also feature rapid operation; see page 5.)

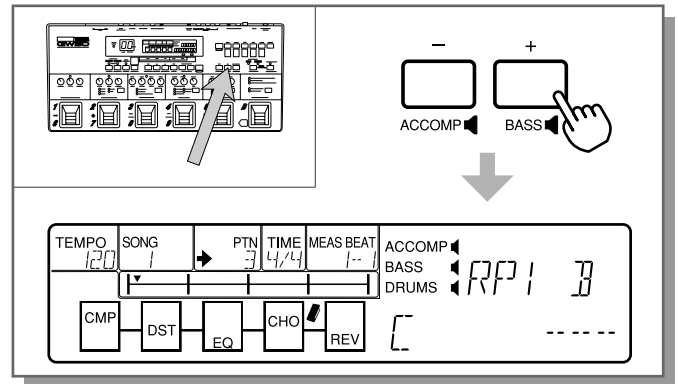

With the exception of the last several patterns (see note on page 73), note that only odd number patterns can be selected here. These are the basic rhythm patterns, and the even ones are Fill In patterns. For example, pattern #1 is the basic pattern and #2 is its companion Fill In pattern. (We'll describe how to play the Fill In patterns in step #5 below.)

4. Press [START/STOP] to play the pattern you've selected. (The LED above the button flashes in time with the rhythm.)

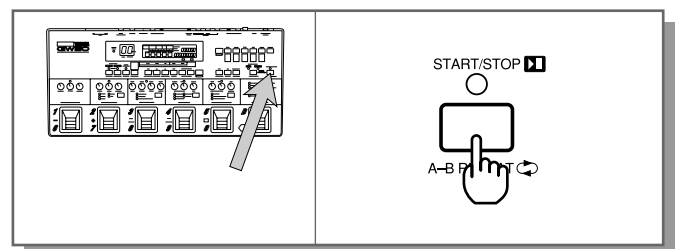

You can also use Pedal Switch 5 (in the Reverb/Delay block) to start the pattern.

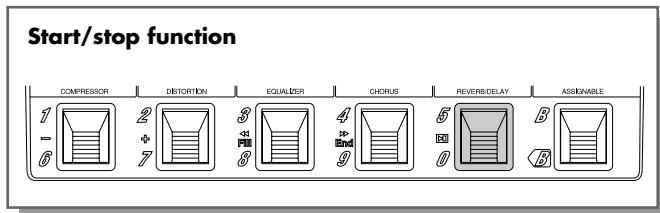

While the pattern is playing, you can use the [-]/[+] buttons to select and listen to other patterns. Try out various patterns to get a feel for the enormous stylistic range of the Backing section. (There are a total of 248 patterns; refer to the list on pages 144 and 145 for more information about them.)

- 5.** Now, play the corresponding fill in pattern by pressing the Fill Pedal Switch (Pedal Switch 3).

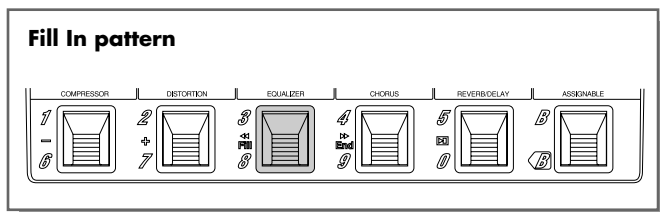

Normally, you should press the Fill Pedal Switch at the beginning of the measure you wish the fill in pattern to play. However, you can press it in the middle of a measure and play only the last part of the fill in.

Note: If you press the Fill Pedal Switch too late in the measure, you may not hear any change from the normal pattern.

- 6.** While one of the patterns is playing, try this: Hold down [SHIFT] and press [ACCOMP].

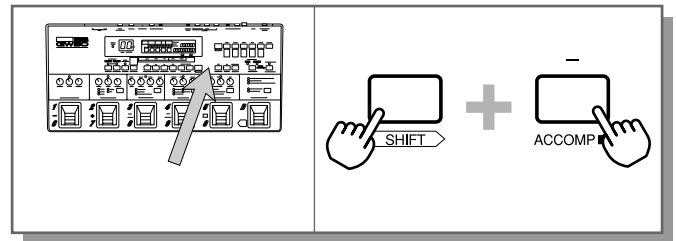

Notice that the accompaniment parts have dropped out, and that all you hear are the bass and drums. To bring the accompaniment back in, hold down [SHIFT] and press [ACCOMP] again. Try doing this in time with the rhythm, pressing the button at the end of a measure.

Try doing the same with the bass and drum parts as well, using [SHIFT] + [BASS] and [SHIFT] + [DRUMS].

After you've played around with this for a while, turn all of the backing sounds back on.

- 7.** Now, let's change chords while the pattern is playing. The automatic chord features of the GW50 are very sophisticated, so for the moment we'll show you one of the easiest ways to change chords — by using the Pedal Switches.

To set this up, press the ASSIGNABLE Type switch until the CHORD RECALL LED is lit. (You can also use the ASSIGNABLE Block Pedal Switch to switch between BACKING CONTROL and CHORD RECALL.)

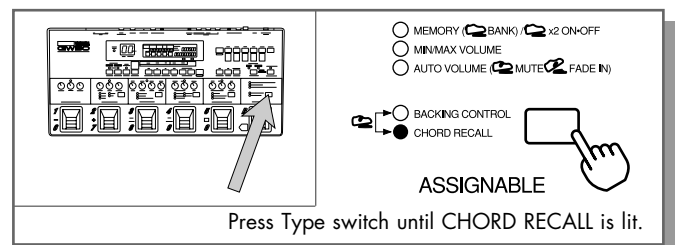

While the pattern is playing, press Pedal Switch 2.

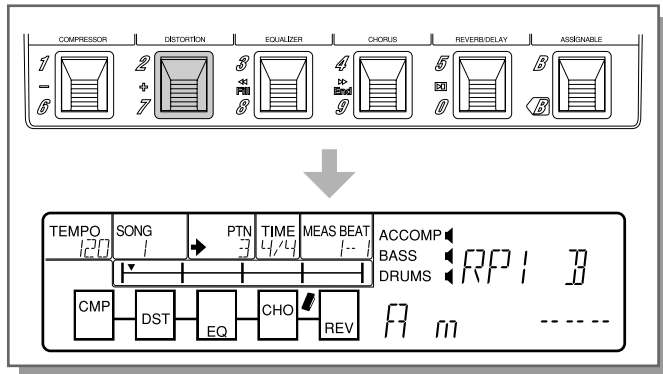

The chord changes as soon as you press the Pedal Switch, and the new chord is shown in the display. Press the other Pedal Switches (1–4) to change to other chords. (These are the factory-assigned chord settings for the Pedal Switches.) Try doing this in time with the rhythm as well.

Note: Be careful not to press Pedal Switch 5 here, since it does not change the chord, but starts or stops the pattern.

8. While the pattern is still playing, try using the chord section at the top right of the panel to select some other chords.

First, let's change the root note of the chord. To do this, press the Chord button corresponding to the desired note (written above the button).

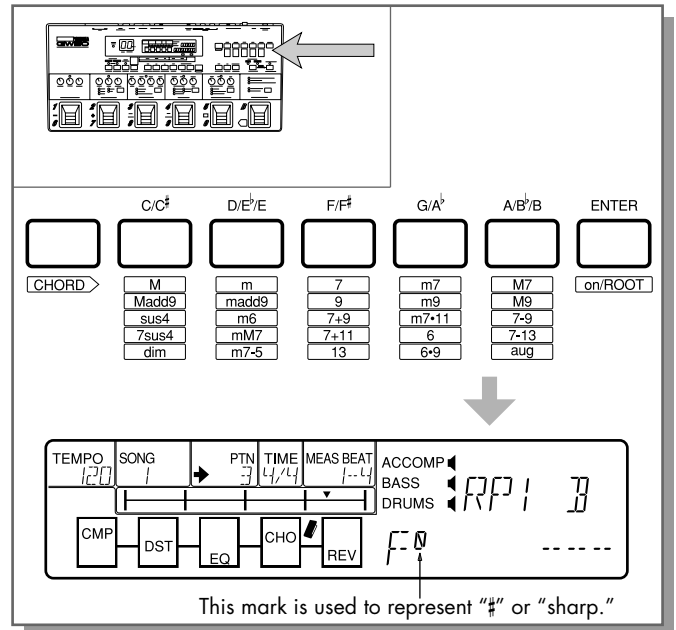

If the root note that you want isn't selected (each button has more than one root note), press it again until the note is selected.

Next, let's change the chord type. Remember that the GW50 gives you a total 25 different chord types for all keys. These chord types are shown below the Chord buttons.

Note: For more information about the chord types, see the lists of chord types on pages 76 and 152.

To select a different chord type, simultaneously hold [CHORD] and press the Chord button corresponding to the desired type (written below the button). Press it repeatedly until the desired chord type is shown in the LCD.

For example, hold [CHORD] and press [D/E^b/E] until the "m" chord is selected.

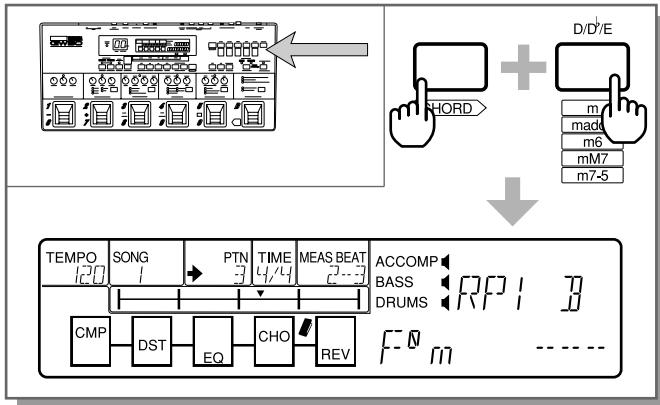

Finally, you can even change the bass note. First, simultaneously hold [CHORD] and press [on/ROOT].

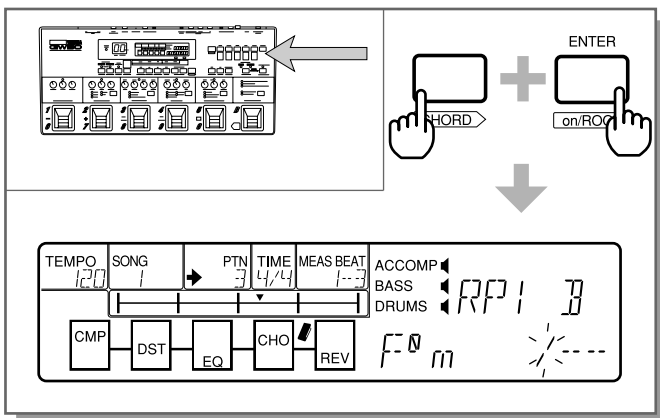

Next, press the Chord button corresponding to the desired note (written above the button). Press it repeatedly until the note you want is shown in the LCD.

For example, to use C# as the bass note, press [C/C#] until the “C/C#” is shown.

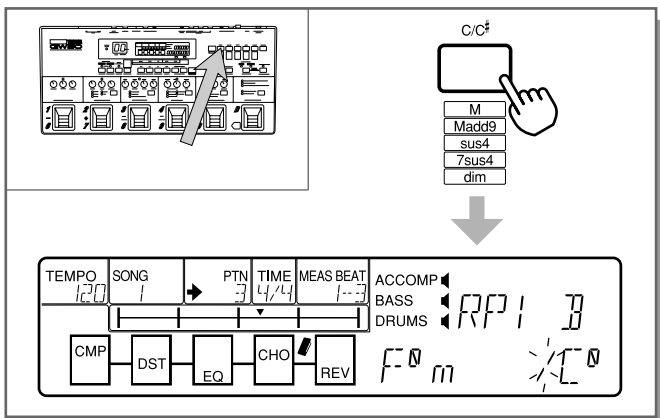

Try pressing other buttons now as the rhythm plays to change to other bass notes.

To cancel this bass note and have the bass line automatically change with the root note again, hold [CHORD] and press one of the Chord buttons to reselect the chord type.



You can also use the chord section functions to assign chords to the Pedal Switches. (See page 78 for details.)

- To stop playing the pattern, press [START/STOP] again (or Pedal Switch 5).

You can also have the pattern stop with a special ending pattern. To do this, first press the ASSIGNABLE Block Pedal Switch to switch to BACKING CONTROL.

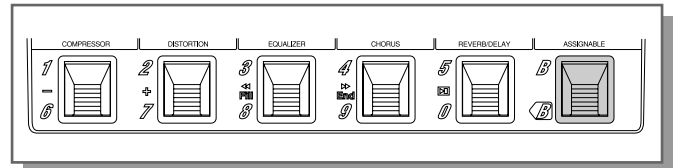

... then press the End Pedal Switch (Pedal Switch 4) while the pattern is playing.

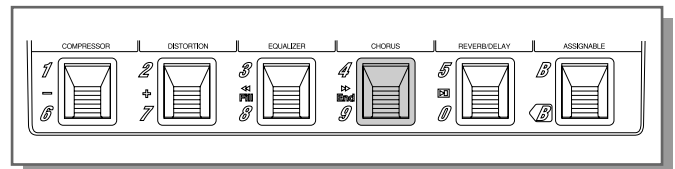

PLAYING AND RECORDING SONGS — SONG MODE

The Song mode has eight songs (made up of the patterns in the Pattern mode) for playing. You can also record your own songs in this mode, using the patterns and chords of the Pattern mode. This provides a simple, yet powerful “sketchpad” for composing, and it also gives you solid, dynamic rhythm parts complete with pre-programmed chord changes for performing along with.

Playing a Song

1. Press [SONG/PATTERN] until the SONG LED lights. This selects the Song mode.

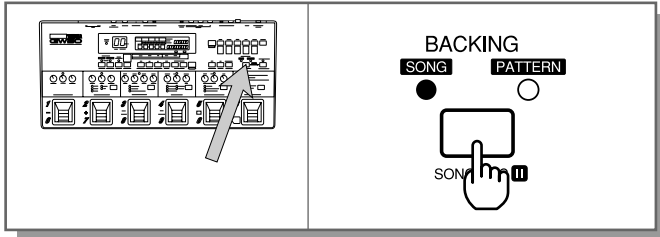

2. Using [6 CURSOR], move the arrow in the display to the SONG box.

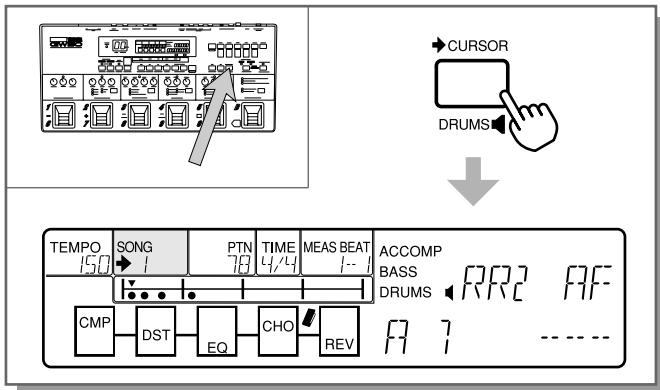

3. Use the [-]/[+] buttons to select a song number. (Refer to page 147 for a list of the available songs and their descriptions.)

4. Press [START/STOP] to start playing the selected song. (The LED above the button flashes in time with the rhythm.)

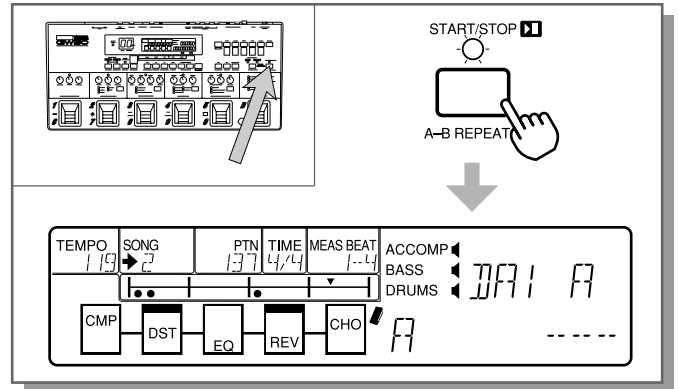

5. When the song is finished playing, playback stops. You can also pause (and resume) playback in the middle of the song by pressing [START/STOP].

Note: If you've stopped playback in the middle of a song and you want to return to the beginning, simultaneously press [n] and [v].

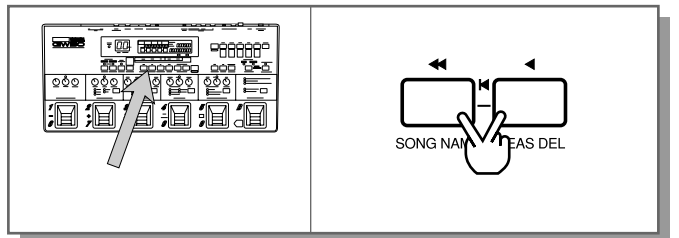

Recording a Song

You can use the drum, bass and accompaniment patterns, along with the chords, as well as other types of data, to create your own songs. Up to eight songs can be recorded, and each song can have up to 299 measures.

Songs can be recorded by using two different methods: Realtime recording and Step recording.

Realtime recording is similar to using a multitrack tape recorder; you can hear the events as you record them, and you can hear previously recorded events as you record new ones on top.

Step recording, on the other hand, allows you to record events one-by-one, using the controls on the panel to “program” them to 16th note divisions of a measure. It is much like writing down notes onto a sheet of music paper; each event is entered one at a time, and you cannot actually hear what the event sounds like as you are entering it.

Each method has its own advantages and uses. Step recording is good for precision and for editing purposes (erasing an event or replacing an event). Realtime recording is best for capturing the “feel” of the song, since it allows you to actually “play” the events in time as you record them.

You can even switch between the two methods, recording the basic parts with Realtime recording, then using Step recording to add details and edit or “clean up” the recording if needed.



RECORDING EFFECT CHANGES—After recording the basic parts of the song (the patterns and chord changes), you can also record effect program changes and their on/off settings in real time as you play. (See page 86 for details.)

To record a song:

1. First select the Song mode by pressing [SONG/PATTERN] until the SONG LED lights.

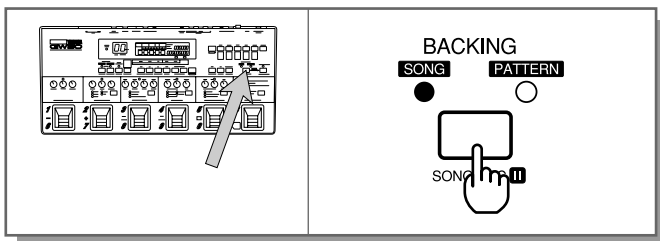

2. Using [6 CURSOR], move the arrow in the display to the SONG box.

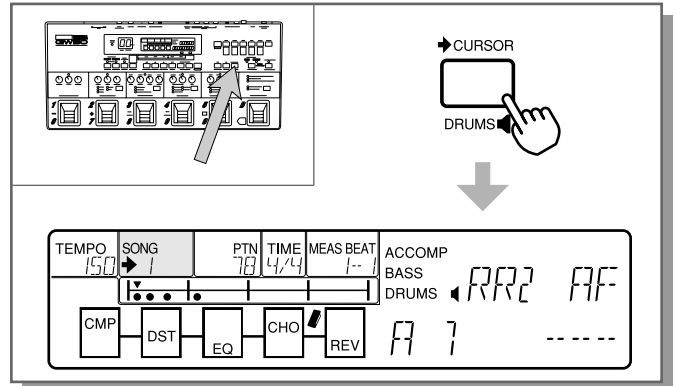

3. Use the [-]/[+] buttons to select a song number. (For this example, select song number 8, since this has deliberately been left blank for you to use in creating your own song.)

Note: AVOID LOSING IMPORTANT SONGS—Once you do any recording to a song, the changes that you make are automatically saved to that song number. For this reason, you should be careful when recording or editing an existing song. There are certain precautions you can take to avoid losing important songs, such as backing up your original ones with the MIDI Bulk Transmission function (see page 102), and restoring factory preset songs (see page 95) if you’ve erased them.

4. Simultaneously hold down [SHIFT] and press [SONG REC].

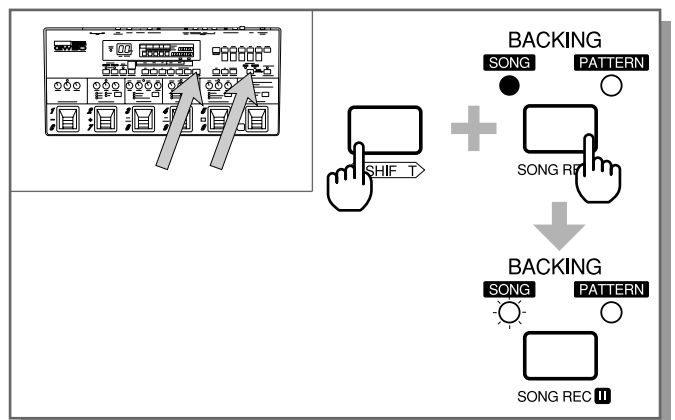

The SONG LED flashes to indicate record standby.

- The first thing to do before actually recording is to select a pattern and a chord to start the song with.

For this example, let's use pattern number 5, and start the song out with a C major chord. You can do this while the GW50 is still in record standby:

Move the cursor arrow in the display to the PTN box, by using [-> CURSOR].

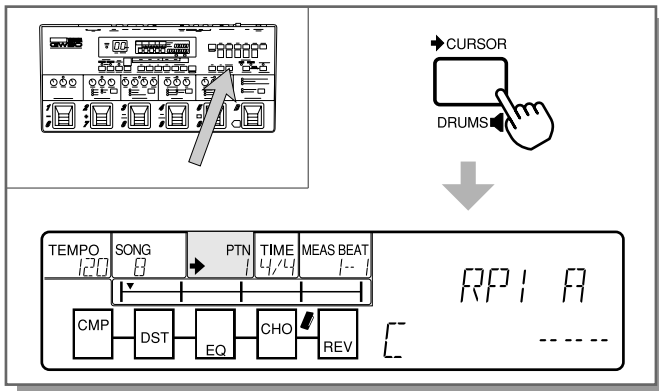

Next, use the [-]/[+] buttons to select pattern number 5. The pattern name appears in the display.

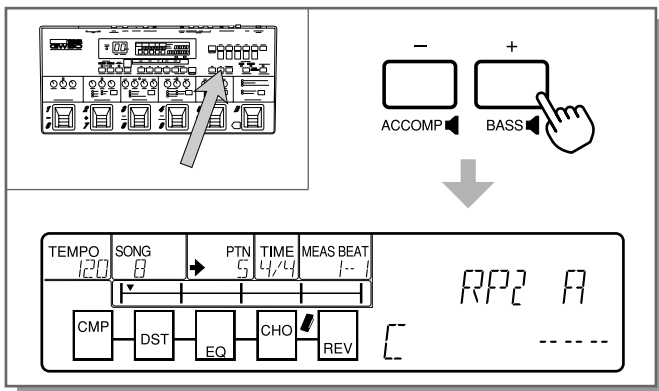

Now, select the chord. Press [C/C#] until "C" is shown in the display. If another chord type appears (such as "C m" or "C SUS4"), simultaneously hold down [CHORD] and press [C/C#] until "C" (C major) is shown.

- Finally, start recording by pressing Pedal Switch 5 (or [START/STOP]). The pattern and the chord you selected are automatically recorded to the first note of the first measure.

- As the recording continues, let's try entering new chords from the Pedal Switches, just as we did in step #7 in the Pattern mode section (see pages 33, 34):

While the song is recording, press Pedal Switch 2.

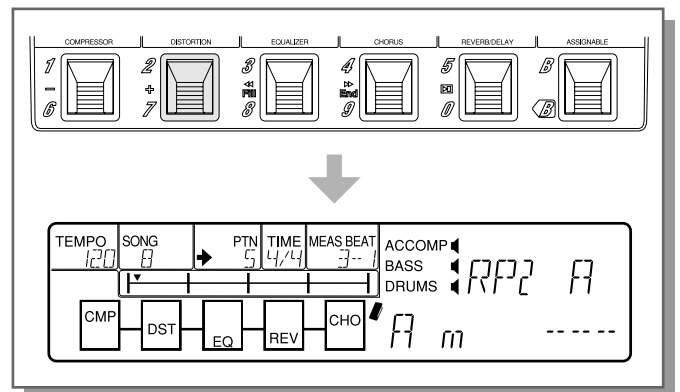

The chord is recorded as soon as you press the Pedal Switch, and the new chord is shown in the display. Press the other Pedal Switches (1-4) to change to other chords, in time with the rhythm.

Note: Be careful not to press Pedal Switch 5 here, since it does not change the chord, but starts or stops the pattern.

- Now, stop the recording by pressing [START/STOP].

If you've made some mistakes while recording above or just want to make some changes or additions, you can always go back to the start of the song and use Step recording techniques to edit the existing song. (See page 88 in the Reference section for information on Step recording.)

USING THE BUILT-IN TUNER

The GW50 has a convenient built-in tuner that lets you tune your guitar without having to disconnect it.

1. Simultaneously hold down [SHIFT] and press [TUNER] (or simultaneously press and hold don Pedal Switches 1 and 2 until the Tuner mode display “PITCH” appears in the LCD).

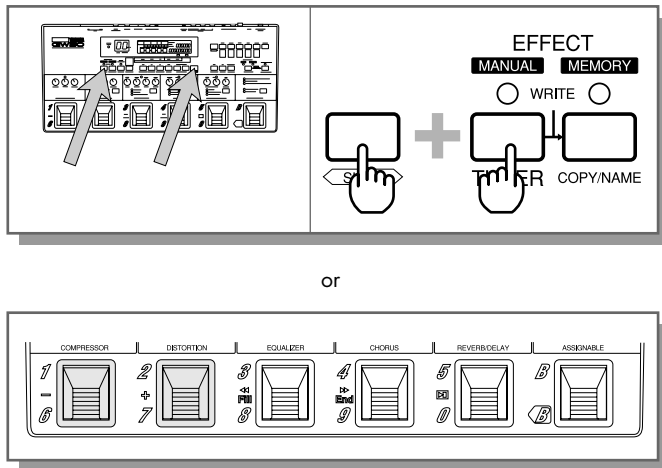

2. Now, making sure that other strings do not sound, play the bottom E string on your guitar. Let the string ring out, so that the tuner receives a fairly constant pitch.

The number of the string and the note name appears in the BANK/MEMORY indicator.

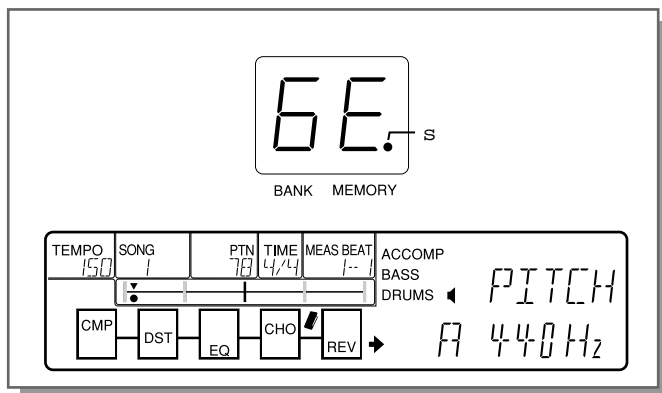

The marks in the display shown above are

toward the left, indicating that the string is slightly flat. When the string is sharp, the marks will be on the right.

Adjust the tuning of the string and play it again. The tuning marks in the display should move toward the center. When they are in or around the center, the string is in tune.

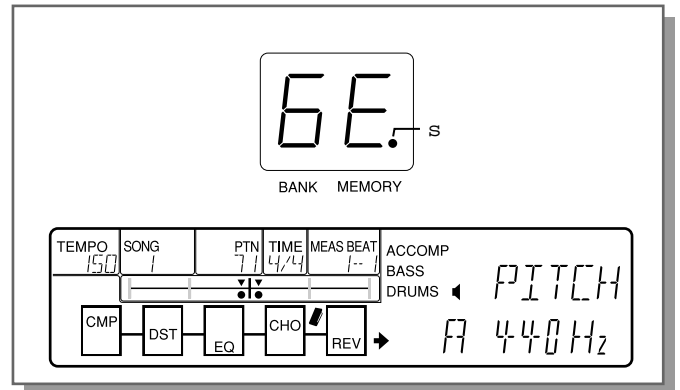

The effect block LEDs also function as tuning indicators when the tuner is used, with the Equalizer block LED serving as the center tuning indicator.

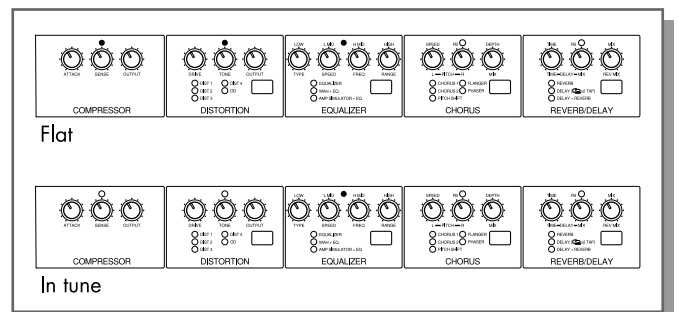

3. Go on and tune the other strings in the same way.

- 4.** Return to normal operation by pressing any of the mode buttons (or any of the Pedal Switches).

This concludes our short tour of some of the functions of the GW50. To find out more about using your GW50, look through the Reference section now and read some of the topics that interest you.



GW50

REFERENCE

EFFECT SECTION

ABOUT THE MANUAL, MEMORY AND MEMORY EDIT MODES	43	ASSIGNABLE Block and Pedal Switch Functions	51
MANUAL MODE	44	Effect Program Selection	51
Selecting an Effect Type	44	Bypass Switching of Effect Blocks	52
Turning Individual Effects On and Off	44	MEMORY EDIT MODE	53
Editing Parameters	44	Compare Mode (Comparing the Edited Program with the Original)	53
Utility Functions	45	Saving the Memory Edit Mode Settings to an Effect Program	53
Determining the Order of the Effect Blocks — CONNECT	45	Recalling the Settings of the Original Program (in Compare Condition)	54
Bypass Switching of Effect Blocks — GROUP	45	MEMORY JOB MODE	54
Setting the Function of the External Foot Controller — FOOT	46	Copying an Effect Program	54
Setting the MINIMUM VOLUME Level (for External Foot Controller and ASSIGNABLE Block Volume Control) — MIN VOL	47	Swapping One Effect Program with Another	55
ASSIGNABLE Block Functions — MIN/MAX Volume and Auto Volume	48	Naming an Effect Program	55
Setting the AUTO VOLUME Rate — AUTO VOL	49	Using an External Footswitch	56
MANUAL JOB MODE	50	RESTORING FACTORY PRESET EFFECT PROGRAMS	57
Saving the Manual Mode Settings to an Effect Program	50	EFFECTS AND PARAMETERS	58
MEMORY MODE	51	COMPRESSOR	58
Selecting Effect Programs	51	DISTORTION	59
Checking Parameter Values of the Effect Program	51	EQUALIZER	59
		CHORUS	63
		REVERB/DELAY	66
		NOISE GATE	69



ABOUT THE MANUAL, MEMORY AND MEMORY EDIT

The Effect section of the GW50 is basically divided into three operating modes: Manual mode, Memory mode and Memory Edit mode.

In the Manual mode, you can use the effect blocks just as you would conventional pedal effects. All parameter knobs are active for adjusting the main parameters, and the sub parameters can be selected and adjusted here as well (see page 44). You can also perform other effect-related operations, such as determining the order of effects, setting the external foot controller, and so on.

To select the Manual mode, press [MANUAL]. (“MANUAL” appears in the display.)

In the Memory mode, you can select effect programs. The GW50 has 50 programs in its internal memory, divided into ten banks of five programs each. The parameter knobs cannot be used here, except to check the set values of the main parameters (see page 51). The Pedal Switches can be used either to select programs or turn effect blocks of a selected program on or off (see pages 51, 52).

To select the Memory mode, press [MEMORY]. (The MEMORY LED lights and the program number is shown in the BANK/MEMORY indicator.)

In the Memory Edit mode, you can create your own effect programs, for selecting later in the Memory mode. As in the Manual mode, all controls are active and you can make main and sub parameter settings, as well as set all other effect-related operations.

Note: ABOUT THE PARAMETER KNOBS—In the Memory and Memory Edit modes, remember that the position of the parameter knobs in the effect blocks does not necessarily correspond to the actual value of the parameters. Also, in the Memory Edit mode, once you adjust a parameter knob — even slightly — the value of that parameter instantly changes to the new position of the knob. (Only the knob adjusted will correspond to the actual value.)

To select the Memory Edit mode, press [EDIT/COMPARE] from the Memory mode. (The EDIT/COMPARE LED lights.)

MANUAL MODE

Selecting an Effect Type

The Distortion, Equalizer, Chorus and Reverb/Delay effect blocks feature different effect types. Press the Type switch to step through the available effects. The LED of the selected effect lights.

Turning Individual Effects On and Off

When not assigned to a group, individual effect blocks can be turned on and off in the Manual mode. To do this, make sure that MEMORY ON/OFF is selected in the ASSIGNABLE Block (the MEMORY LED flashes), then press the Pedal Switch of the appropriate effect block. The LED of the selected effect lights when the effect is on. (For information on assigning effects to a group, see page 45.)

Editing Parameters

Effect parameters can be edited in the Manual mode. The Manual mode is designed to be a kind of “blank slate” on which you can make settings as you wish. If you create some settings in the Manual mode that you want to keep as an effect program, save them to a program number (see “Saving the Manual Mode Settings to an Effect Program,” page 50).

Editing the Main Parameters

1. Select the desired type of effect with the Type button in each effect block.
2. Adjust the desired parameters with the knobs in each effect block. (The display automatically shows the adjusted parameter name and value.)

Editing the Sub Parameters and Noise Gate

1. Simultaneously hold down [SHIFT] and press [SUB PARAM].

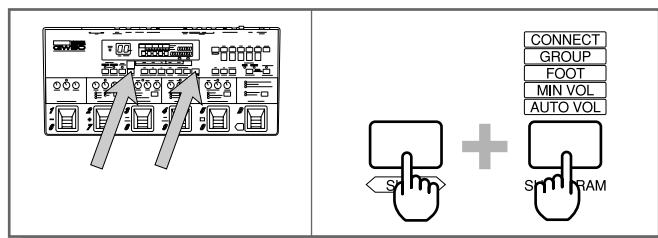

2. To select a parameter, keep holding down [SHIFT] and repeatedly press [SUB PARAM] to step through the sub parameters for all selected Equalizer, Chorus and Reverb/Delay effects (indicated by the lit green LEDs in the effect blocks) and the Noise Gate.

Or, after step #1, release [SHIFT] and simply press one of the effect selector buttons beneath the LCD ([EQ], [CHO], and [REV]) to step through the sub parameters of the corresponding effect. Pressing [CMP] or [DST] selects the Noise Gate parameter.

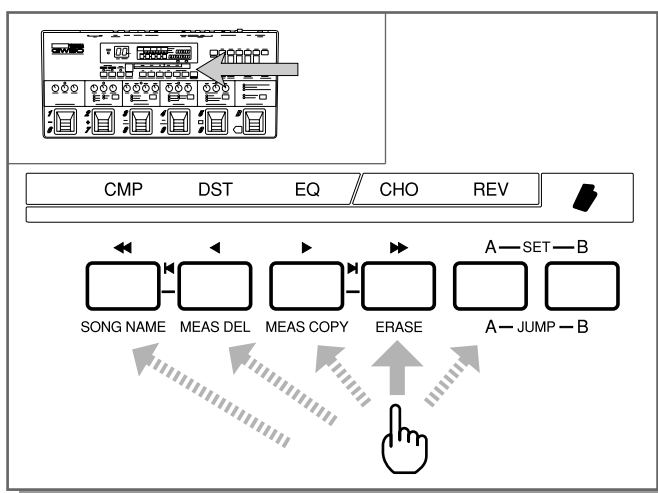

3. Adjust the selected parameter with the [-]/[+] buttons.

- Exit this operation by pressing any of the mode buttons ([MANUAL], [MEMORY] or [SONG/PATTERN]).



FOR EASIER EDITING—You can easily switch back and forth between editing main and sub parameters in any of the effects by first selecting the sub parameters (as done in step #1 above). After that, you can edit the main parameters as usual, and switch back to the sub parameters at any time by pressing the appropriate effect selector buttons.

Utility Functions

There are five Utility functions: CONNECT, GROUP, FOOT, MIN VOL and AUTO VOL. The Utility functions can be executed from both the Manual and Memory Edit modes (however, the following explanation refers only to the Manual mode). To exit any of these operations, press any of the mode buttons ([MANUAL], [MEMORY] or [SONG/PATTERN]).

Determining the Order of the Effect Blocks — CONNECT

The Connect function allows you to determine in what order the effect blocks will be used to process the signal.

Operation —

- From the Manual mode, repeatedly press the Effect Utility switch until “CONNECT” is shown in the display.

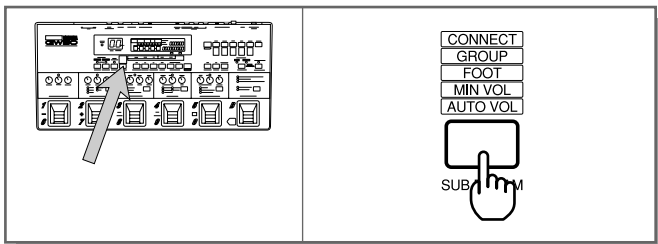

- Press the corresponding Effect Selector buttons in the order that you wish the effects to be placed. (The selected effect configuration is shown graphically in the display, with

boxes representing the blocks in order from left to right.) Compressor, Distortion and Equalizer must always be among the first three blocks; Chorus and Reverb must be the last two.

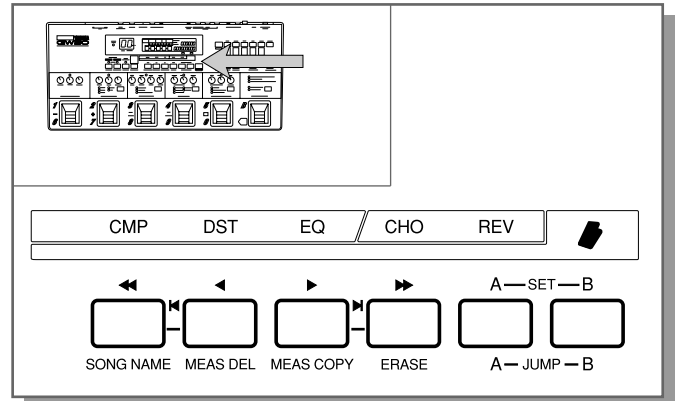

For example, if you press [EQ] first, the display will prompt you to press either [CMP] or [DST]. Then, if you press [CMP], Distortion (DST) will automatically be assigned to the third block. Finally, determine the order of the last two effects by pressing either [CHO] or [REV]; the one NOT pressed will automatically be assigned to the fifth block.

Repeat steps #1 and #2 above if you want to change the order again.



For best results in connecting the various effects, follow these guidelines:

- * When using the Equalizer or Amp Simulator effects with Distortion, put Distortion BEFORE the EQ block.
- * When using the Wah effect with Distortion, put Distortion AFTER the EQ block.

Bypass Switching of Effect Blocks — GROUP

The Group function allows you to determine which effect blocks are grouped together for one-press effect bypassing. The effect blocks that have been assigned here can be switched off or on all together by pressing any one of the Pedal Switches of those effects (when MEMORY ON/OFF is selected in the ASSIGNABLE block). (Also see “Bypass Switching of Effect Blocks” on page 52.) For example, if Compressor, Distortion and Chorus have been

grouped together, pressing any of those Pedal Switches alternately bypasses or activates all those effects simultaneously.

Operation —

1. From the Manual mode, repeatedly press the Utility button until “GROUP” is shown in the display.
2. Press the Effect Selector buttons (CMP, DST, EQ, etc.) corresponding to the effect blocks you wish to assign to the group.

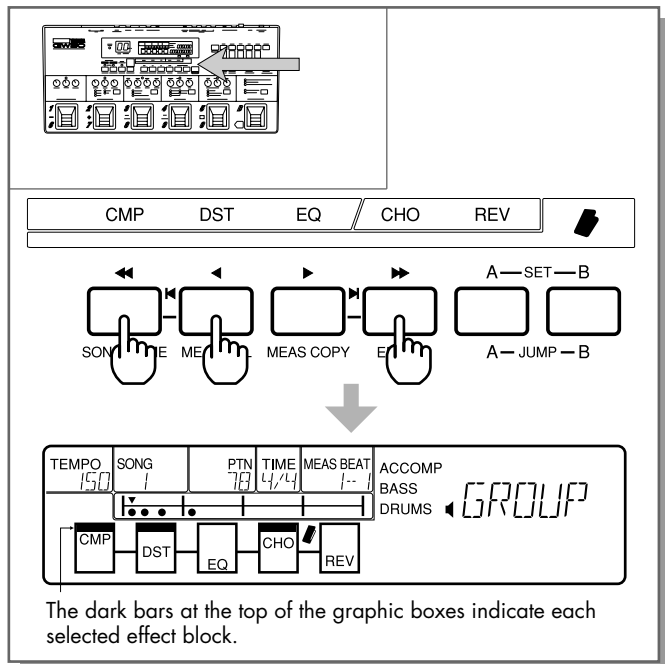

When MEMORY ON/OFF is selected in the ASSIGNABLE Block (MEMORY LED flashes), the assigned effect blocks can be switched on and off all together by pressing any one of their Pedal Switches. Unassigned effects can be switched off and on normally from their individual Pedal Switches.

To turn off the group assignment, press the appropriate Effect Selector button again. Repeat steps #1 and #2 above if you want to change the assignment again.

Setting the Function of the External Foot Controller — FOOT

The Foot function here determines how the connected foot controller (the optional Yamaha FC7) is to be used: whether for realtime control over certain effect parameters, or as a volume pedal.

Operation —

1. From the Manual mode, repeatedly press the Utility button until “FOOT” is shown in the display.
2. Repeatedly press [SET-B] (the Foot Controller button, indicated by the pedal graphic on the panel) to step through the settings. The available settings are: Volume Pedal, Wah Pedal, Distortion Drive, Chorus Depth, Reverb Feedback, and Reverb Mix.

■ Using as a Volume Pedal

Volume Pedal (VOL PEDAL) — For using the foot controller to control the volume of the input signal, at programmable points in the effect chain. Each press of [SET-B] steps through the various positions.

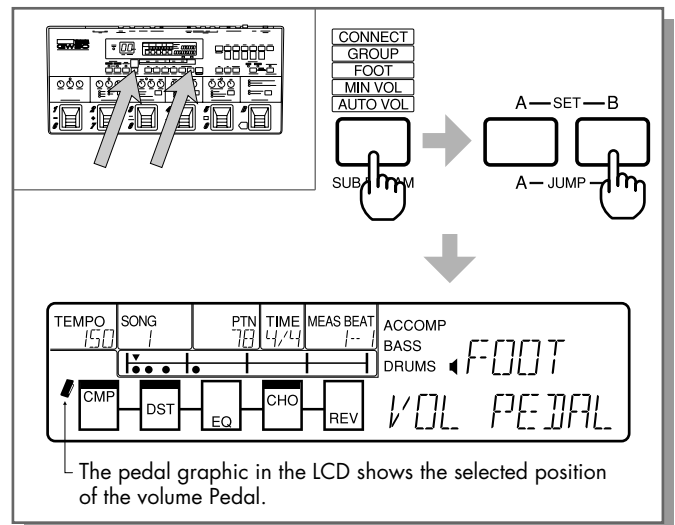

Note: VOLUME PEDAL PLACEMENT—Since placing the Volume Pedal before the Equalizer may result in some added noise, generally it should be used after the Compressor, Distortion and Equalizer except when using it to control the Distortion Input level.



You can set the minimum volume of the foot controller to a value other than zero (for example, when you want to use the foot controller to easily move between loud and soft settings). See “Setting the MINIMUM VOLUME Level” on page 47 for details.

■ Using as a Wah Pedal

Wah Pedal — For using the foot controller to control the Wah effect or filter sweep, when the Wah + EQ effect is selected in the Equalizer block. (When the external foot controller is set to Wah Pedal operation here, the Wah + EQ Type parameter is automatically set to PEDAL.) Refer to page 61 for more information on the Wah + EQ effect.

■ Using for Control of Other Parameters

Distortion Drive (DST DRIVE) — For using the foot pedal to control the Distortion Drive parameter (see page 59).

Chorus Depth (CHO DEPTH) — For using the foot controller to control the Depth parameter of the Chorus, Flanger or Phaser effects, or the Mix parameter of the Pitch Shift effect (see pages 64-66).

Reverb Feedback (REV FB) — For using the foot controller to control the High parameter of the Reverb effect, the Feedback parameter of the Delay effect, or the Delay Mix parameter of the Delay + Reverb effect (See pages 67-69).

Reverb Mix (REV MIX) — For using the foot controller to control the Reverb Mix parameter of the Reverb effect, the Delay Mix parameter of the Delay effect, or the Reverb Mix parameter of the Delay + Reverb effect (See pages 67, 68).

Note: When selecting Wah Pedal and control of other parameters for the foot controller, make sure that the foot controller is properly connected to the GW50.

Note: When using the foot controller as a Wah pedal or to control one of these other parameters, the ASSIGNABLE Block functions MIN/MAX VOLUME and AUTO VOLUME apply only to the volume of the first three effects (Compressor, Distortion and Equalizer).

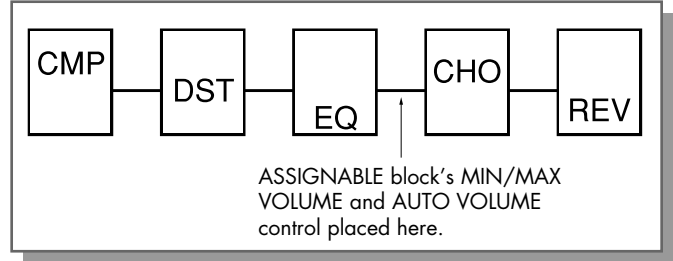

Setting the MINIMUM VOLUME Level (for External Foot Controller and ASSIGNABLE Block Volume Control) — MIN VOL

When using the connected foot controller as a volume pedal (see previous page), you can set the minimum volume for the controller from the GW50.

When using the ASSIGNABLE Block Pedal Switch to control MIN/MAX Volume or Auto Volume (see pages 48, 49), this parameter also determines what the minimum volume will be for both of these functions.

Operation —

1. From the Manual mode, repeatedly press the Utility button until “MIN” is shown in the display.
2. Use the [-]/[+] buttons to set the desired Minimum Volume value. (Range: 0–9)

A minimum setting of “0” results in no output or off, while a maximum of “9” results in the same level as normal (or no volume change).

Note: Keep in mind that a maximum setting of “9” results in no volume change for ALL related functions — the foot controller, and the ASSIGNABLE Block Pedal Switch’s MIN/MAX Volume and Auto Volume functions.



ASSIGNABLE Block Functions — MIN/MAX Volume and Auto Volume

The ASSIGNABLE Block Pedal Switch has two volume-related functions: MIN/MAX Volume and Auto Volume. (These are available in all modes — Manual, Memory and Memory Edit.) Select one of them by pressing the ASSIGNABLE Block Type switch. (The LED next to the selected function lights.)

Minimum/Maximum Volume

When this is selected, you can use the ASSIGNABLE Block Pedal Switch to instantly change between high and low output level. Press the Pedal Switch once to switch to low (minimum) volume (the LED flashes), and once again to switch back to high (or normal) volume (the LED is lit continuously).

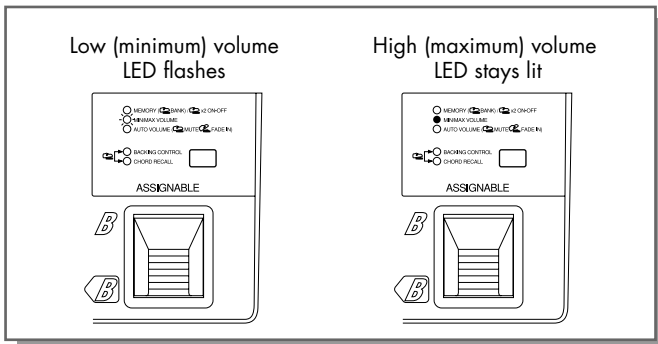

Note: MIN/MAX VOLUME AND EFFECT PROGRAM CHANGES—When the MIN/MAX Volume function is set to minimum or low volume (the MIN/MAX VOLUME LED flashes), the volume does not change even when other effect programs are selected with Pedal Switches 1–5. However, the volume reverts back to normal when effect program changes are made from the [-]/[+] buttons or from events in a song.



The main use of this function is to change volume instantly as you play, for example, when you need to instantly go from playing a backing, rhythm guitar part to playing a solo.

Use the Minimum Volume parameter to set the low (minimum) volume. (See page 47.)



For ease in making the low volume setting, press the ASSIGNABLE Block Pedal Switch to turn the MIN Volume on, then play the connected instrument and listen to the sound as you adjust the MIN Volume value.

Auto Volume

When this is selected, you can use the ASSIGNABLE Pedal Switch as a kind of automatic swell function, to automatically fade up the output level. The fade starts from silence or low volume and increases to normal level, according to the rate set with the Auto Volume Rate parameter (see page 49).

Operation —

1. Make sure that the AUTO VOLUME LED is lit (use the ASSIGNABLE Block Type switch to select it), then press and hold down the ASSIGNABLE Block Pedal Switch. The LED flashes indicating that the minimum volume setting is in effect.

Note: The change to minimum volume is not instantaneous. Some time is required for minimum volume to be reached.

2. Release the Pedal Switch and the level begins to fade up. (The LED stays flashing during the fade up.)

- 3.** The LED stops flashing and remains lit when the fade up is complete and the volume is at maximum.

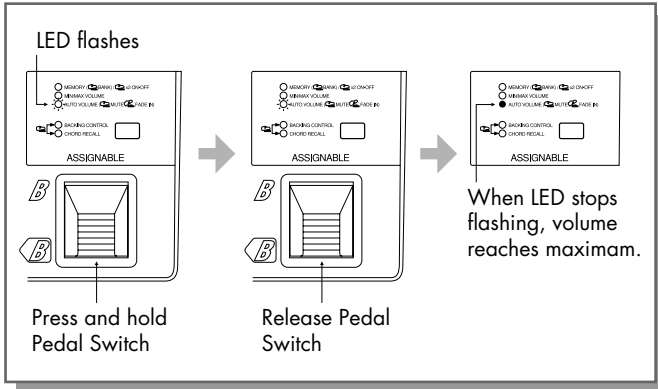

Applications of this would include imitating the slow attack of other instrument sounds like a softly-bowed violin, or a pedal steel guitar. Since Auto Volume cuts off the picking sound and slowly brings up the level, it is ideal for playing soft, lyrical solos.

Note: The low volume of this function (or the level at which the fade in starts) is determined by the Minimum Volume parameter. (See page 47.)



Setting the AUTO VOLUME Rate — AUTO VOL

When using the ASSIGNABLE Block Pedal Switch to control the Auto Volume (see page 48), this parameter determines the rate (speed) at which the volume automatically fades up.

Operation —

- 1.** From the Manual mode, repeatedly press the Utility button until “AT VOL” is shown in the display.
- 2.** Use the [-]/[+] buttons to set the desired Auto Volume Rate. (Range: 1–10)
A minimum setting of “1” results in a slow fade in, while a maximum of “10” results in a nearly instantaneous return to normal level. (See the graph below.)

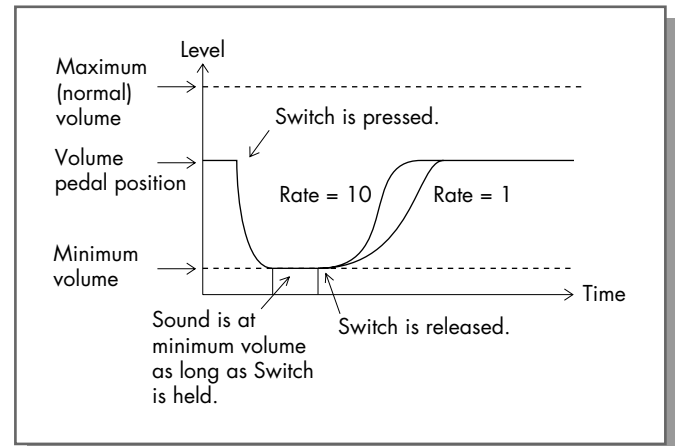

MANUAL JOB MODE**Saving the Manual Mode Settings to an Effect Program**

Operation —

1. After making the desired effect settings in the Manual mode, simultaneously hold down [MANUAL] and press [MEMORY]. (The [MEMORY] LED and BANK/MEMORY indicator flash.)

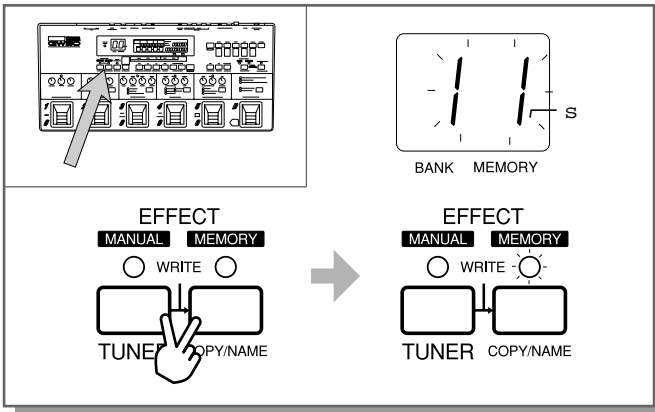

2. Select the destination program number with the [-]/[+] buttons.
3. To save, select “GO” (press [SET-B]). To cancel and return to Manual mode, select “EXIT” (press [SET-A]).

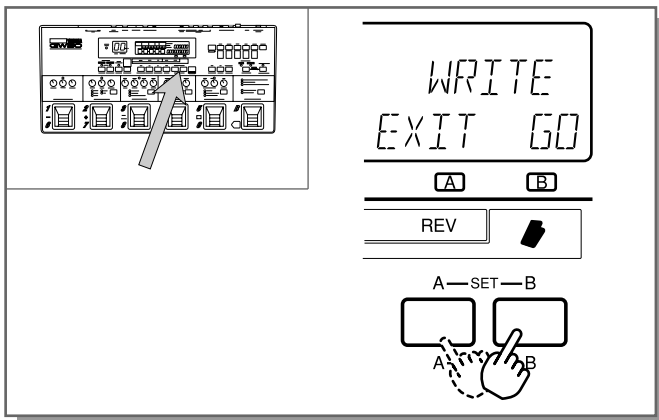

Be careful when performing this operation, since it automatically and irretrievably erases the program at the destination.

Note: When the settings have been saved, “COMPLETED” is shown in the display and operation automatically goes to the Memory mode.

Data Saved to an Effect Program

When you save an effect program, all the following data is saved together with it:

- * Effect types for each block
- * Effect parameters (main and sub) for each block
- * Bypass status of each effect block
- * Noise gate setting
- * Utility function settings (Connect, Group, Foot Controller, Minimum Volume, Auto Volume)

Note: When you save the settings in the Manual mode to an effect program, the GW50 automatically gives it a name, starting with the letters “MEM” and followed by the bank number and memory number to which it has been saved (e.g., “MEM 15”).

MEMORY MODE

Selecting Effect Programs

Operation —

1. Select the Memory mode by pressing [MEMORY] (even if the MEMORY LED is lit).
2. Use the [-]/[+] buttons to step up or down through the programs in order, or use the Pedal Switches. (See page 11 for more details on using the Pedal Switches.)

The effect program name appears in the LCD.

Note: If the cursor arrow in the display is at “TEMPO,” “SONG” or “PTN,” the [-]/[+] cannot be used to select effect programs and the Backing-related display appears instead of the effect program name. In this case, use [6 CURSOR] to move the cursor arrow “out” of the display.

Checking Parameter Values of the Effect Program

In the Memory mode, effect parameters cannot be edited (this is done in the Manual mode or Memory Edit mode). However, you can check the values of the main parameters of the selected effect program by turning the desired parameter knob. The selected parameter’s current value is shown in the screen and does not change even when the knob is turned. (Sub parameters cannot be viewed from the Memory mode. However, you can check these values without altering them from the Memory Edit mode; see page 53.)



ASSIGNABLE Block and Pedal Switch Functions

Effect Program Selection

Operation —

1. Making sure that MEMORY is selected in the ASSIGNABLE Block (the MEMORY LED should be lit; if flashing, press the ASSIGNABLE Block Pedal Switch once), press the desired Pedal Switch, 1–5. This selects programs 1–5 in the current bank. For example, if bank 2 is currently selected, pressing Pedal Switch 3 selects program number 23.
2. To change among banks 1–5, press the ASSIGNABLE Block Pedal Switch and then the appropriate Pedal Switch, 1–5.

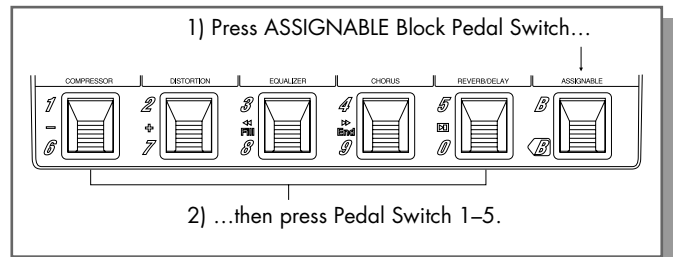

To change among banks 6–0, simultaneously hold down the ASSIGNABLE Pedal Switch and then the appropriate Pedal Switch, 6–0.

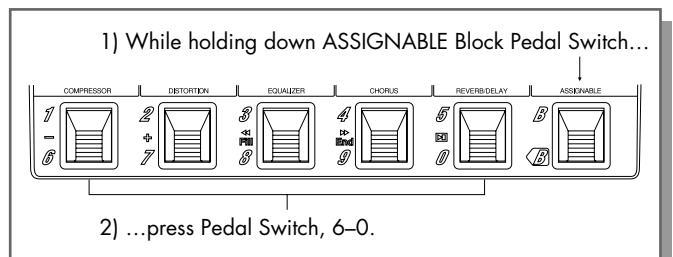

Bypass Switching of Effect Blocks

The Pedal Switches can also be used to bypass or activate individual effect blocks or the assigned effect Group.

Operation —

1. In the Memory mode, press the Type switch in the ASSIGNABLE Block until the MEMORY LED is lit.
2. To select bypass operation, press the ASSIGNABLE Block Pedal Switch twice quickly.

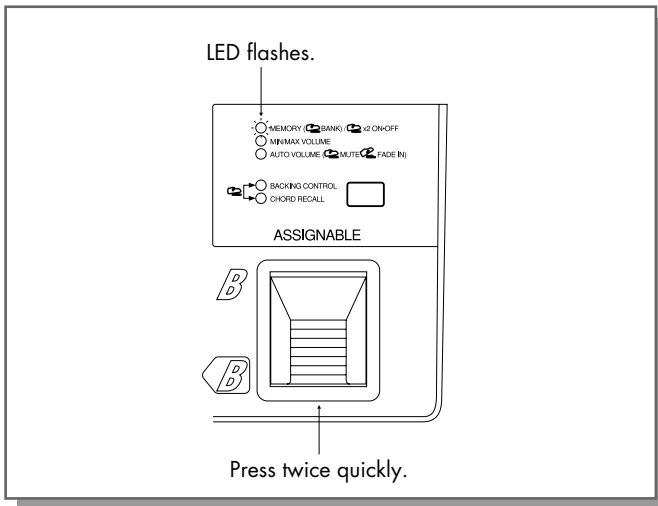

3. In this condition, the Pedal Switches can be used as bypass on/off switches. Those effect blocks as part of a group can be switched on and off together, while those not part of a group can be switched on and off individually. The LEDs of the effect blocks are lit in red when the effects are on.

Note: When [MANUAL] is pressed, the bypass function is automatically selected (the MEMORY LED in the ASSIGNABLE Block flashes). When [MEMORY] is pressed, either the bypass function (LED flashes) or the effect program selection function (LED is lit continuously) is automatically selected, depending on the last setting made.

Note: Whether the ASSIGNABLE Block is set for use as a bypass switch (the MEMORY LED is flashing) or as a bank/program selector (the MEMORY LED is lit continuously), you can also select the MINIMUM VOLUME and AUTO VOLUME functions of the ASSIGNABLE Block Pedal Switch. Either of these functions can be performed with the ASSIGNABLE Block Pedal Switch without disturbing the bypass or effect program selection operations (excepting bank selection) of the effect block Pedal Switches. (See pages 10, 11 for more information.)

4. Press the ASSIGNABLE Block Pedal Switch once to return to normal operation in the Memory mode.



You can also use the external footswitch as an total effect bypass switch to turn all active effects on or off; see page 57 for details.



MEMORY EDIT MODE

The Memory Edit mode is similar to the Manual mode in that all effect parameters can be edited and the resulting program stored to memory. However, the Memory Edit mode uses an existing effect program's parameters as the basic "material" for editing; the new program you create by editing in the Memory Edit mode can be saved to the currently selected program number.

To enter the Memory Edit mode, first select the effect program you wish to edit from the Memory mode, then press [EDIT/COMPARE]. (The orange EDIT/COMPARE LED lights.)

For information on editing effect parameters and the Utility settings (which can also be done from the Memory Edit mode), refer to the relevant sections in "MANUAL MODE" above. For information on saving an effect program from the Memory Edit mode, see the section "Saving the Memory Edit Mode Settings to an Effect Program" below.

Compare Mode (Comparing the Edited Program with the Original)

Once you've made edits to a program, you can compare the sound (and values) of the new program with that of the original one. To do this, press [EDIT/COMPARE]. (The orange LED above the button and the program number in the display both flash, indicating that the original program settings are active.)

Press [EDIT/COMPARE] again to return to the edited values.

In the compare condition, you can also check the main parameter values of the original program simply by turning the desired parameter knob. To check its sub parameters, follow the same steps as given in "Editing the Sub Parameters" in "MANUAL MODE" above. (The parameter values cannot be changed here, however; an "EXIT COMPARE" message appears if you press the [-]/[+] buttons.)



PERIODICALLY CHECK YOUR EDITS—While you edit an effect program, you should regularly and often compare the sound with the original. In this way, if you find that you like the original value of a parameter better than the value you most recently set, you can recall the original program settings (see page 54). Remember, though, that this permanently erases whatever edits you have made.

Note: No other effect operation (except for checking parameter values and settings) can be performed while Compare is on. To exit the Compare function, press [EDIT/COMPARE]. (The EDIT/COMPARE LED will stop flashing.)



Be careful not to inadvertently press [MANUAL] or [MEMORY] at any time in the Edit or Compare conditions. Important data could be irretrievably lost. (See the sections on Saving and Recalling programs below for more information.)

Saving the Memory Edit Mode Settings to an Effect Program

Operation —

After making the desired effect settings in the Memory Edit mode, simply press either [MANUAL] or [MEMORY]. The following display appears.

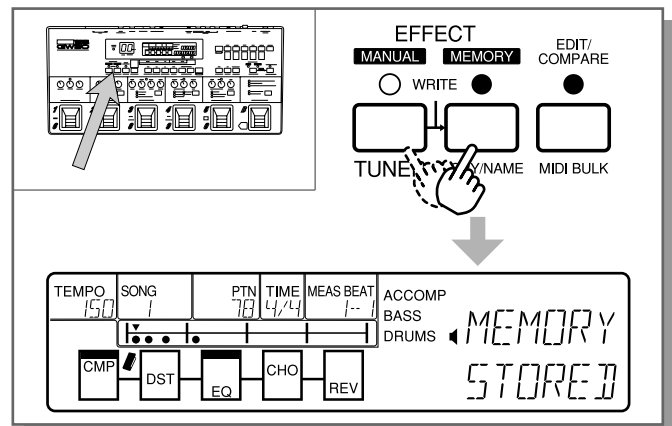

The mode then returns to either Manual or Memory, depending on the button pressed.

Recalling the Settings of the Original Program (in Compare Condition)

At any time during editing, you can recall the settings of the original program. Keep in mind, however, that this permanently erases whatever edits you have made.

Operation —

To recall the original program settings, simply press either [MANUAL] or [MEMORY] while in the Compare condition (the EDIT/COMPARE LED is flashing). The following display appears.

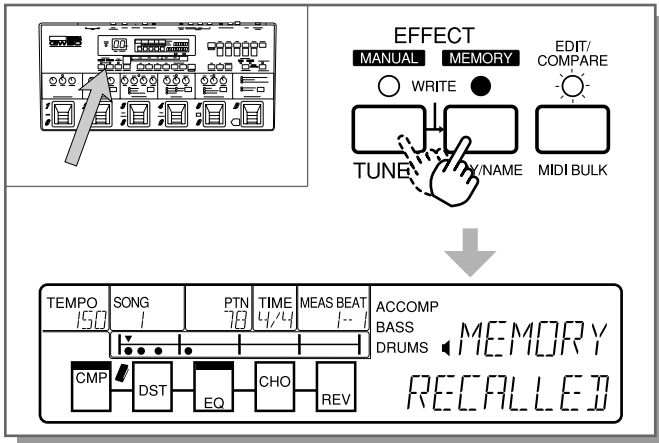

The mode then returns to either Manual or Memory, depending on the button pressed.



AVOID LOSING IMPORTANT DATA—After you’ve made edits to the program, be careful NOT to press [MANUAL] or [MEMORY] unless you are absolutely sure that you want to either recall the original program or save the new one. Be careful also to check which condition is active — Edit (with the continuously lit LED) or Compare (with the flashing LED). If you mistakenly press [MANUAL] or [MEMORY] in either condition, you may irretrievably lose important data!

Note: Regarding the above caution, there are certain precautions you can take to avoid losing important programs, such as backing up your original ones with the MIDI Bulk Transmission function (see page 102), and restoring factory preset programs (see page 57) if you’ve erased them.

MEMORY JOB MODE

Copying an Effect Program

Operation —

1. In the Memory mode, select the effect program to be copied.
2. Simultaneously hold down [SHIFT] and press [COPY/NAME] repeatedly until the Copy display appears.

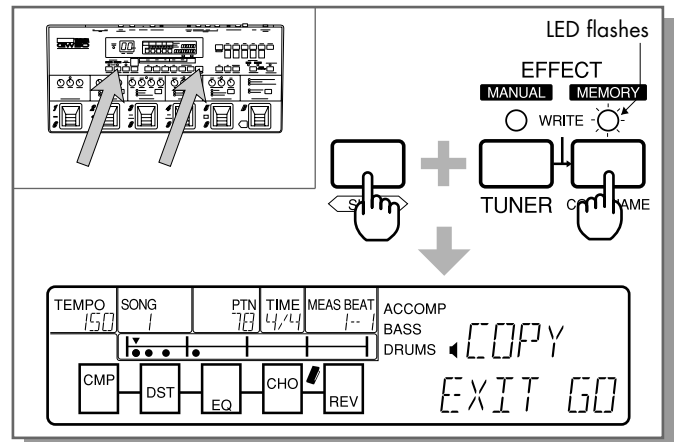

3. Select the destination program number with the [-]/[+] buttons.
4. To copy the selected program to the destination number, select “GO” (press [SET-B]). To cancel and return to Memory mode, select “EXIT” (press [SET-A]), or press any of the mode buttons.



Be careful when performing this operation, since it automatically and irretrievably erases the program at the destination.

Swapping One Effect Program with Another

This is a simple renumbering operation, similar to Copy above, that lets you switch the program numbers of two effect programs.

Operation —

1. In the Memory mode, select one of the effect programs to be swapped.
2. Simultaneously hold down [SHIFT] and press [COPY/NAME] repeatedly until the Swap display appears.

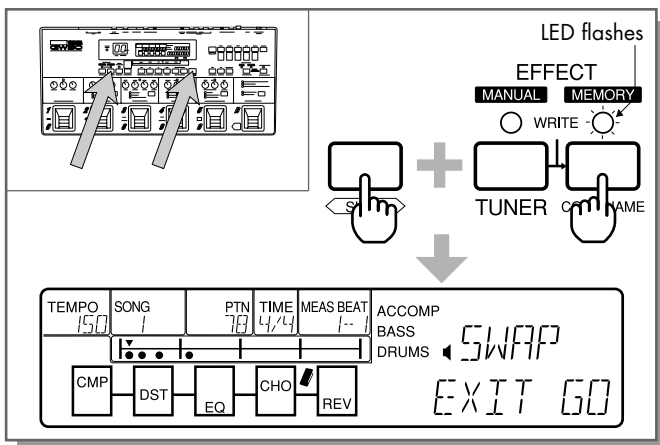

3. Select the other program number with the [-]/[+] buttons.

4. To swap the two selected programs, select “GO” (press [SET-B]). To cancel and return to Memory mode, select “EXIT” (press [SET-A]), or press any of the mode buttons.

Note: This operation changes or swaps all data, including the program name, to the designated program number.

Naming an Effect Program

Operation —

1. Select the effect program to be named, or use the program currently being edited.

Note: Naming can only be done in the Memory mode. If you are editing in the Manual mode, simultaneously press [MANUAL] and [MEMORY], select the destination program number with the [-]/[+] buttons, then [SET-B] to save the effect program before naming it. (When you save the settings in the Manual mode to an effect program, the GW50 automatically gives it a name, starting with the letters “MEM” and followed by the bank number and memory number to which it has been saved.) If you are editing in the Memory Edit mode, press [MEMORY] to save the program and return to the Memory mode before naming it.

2. Simultaneously hold down [SHIFT] and press [COPY/NAME] repeatedly until the Name display (“MEM<”) appears.

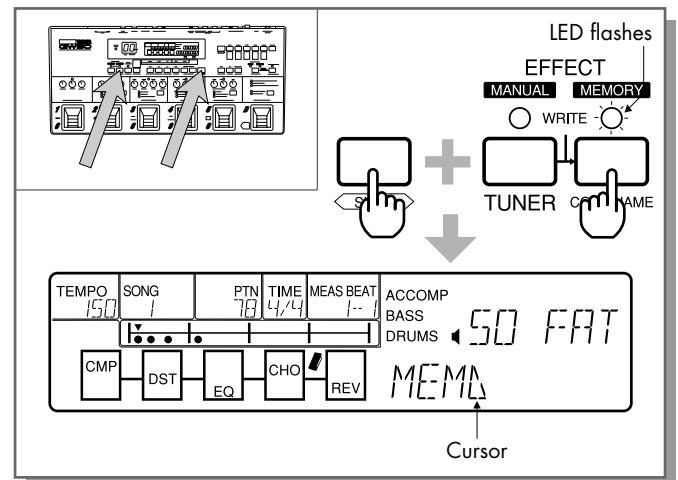

- Use the [-]/[+] buttons to select the desired character at the cursor (<) position. Use [6 CURSOR] to move the cursor (<) in the display. The following characters are available:

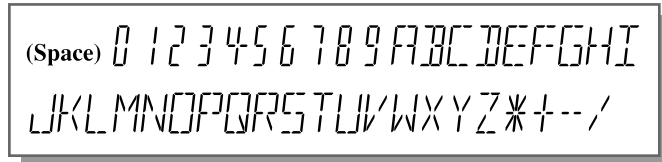

- Press [MANUAL] or [MEMORY] to return to the desired mode. The name is automatically saved to the program.



Using an External Footswitch

An optional external footswitch (the Yamaha FC5 or FC4) can be used to perform certain operations, letting you execute the selected operation without having to use the appropriate panel controls.

The following operations can be assigned to the footswitch:

- * Entering and exiting the Tuner mode (pressing [SHIFT] + [TUNER])
- * Switching between functions in the ASSIGNABLE Block (pressing the ASSIGNABLE Block Type switch)
- * Changing the effect type in an effect block (pressing the effect block Type switch)
- * Starting/stopping a song or pattern (pressing [START/STOP])
- * Switching Pedal Switch operation between bank select and Memory select or effect on/off. (Normally, this is done by pressing the ASSIGNABLE Block Pedal Switch. However, if the MIN/MAX VOLUME or AUTO VOLUME functions are active, the ASSIGNABLE Block Pedal Switch is used for either of these. Assign the footswitch to substitute for this ASSIGNABLE Block Pedal Switch function when you are using the MIN/MAX VOLUME or AUTO VOLUME functions.)

- * Total effects bypass (Turning all active effects on/off) (See “Using the External Footswitch as a Total Effect Bypass Switch” below.)

Operation (other than *)—

- Connect the footswitch to the FOOT SW jack on the rear panel.
- Simultaneously hold the footswitch down and press the switch corresponding to the operation that you wish to control with the footswitch.

For example, if you want to use the footswitch to start and stop the Backing Song or Pattern, hold down the footswitch and press [START/STOP].

- Release the footswitch. It can now be used instead of the panel switch you selected in step #2.

Note: To use the footswitch for entering and exiting the Tuner mode:

- Hold down the footswitch.
 - Press and hold down [SHIFT].
 - Then while holding the two above, press [TUNER] and release the buttons and footswitch.
-

Note: Functions other than those listed above are not controllable with the footswitch.

Even if you’ve properly assigned one of the functions listed above to the footswitch, certain messages (such as “NOT AVAILABLE,” “STOP SONG,” “STOP PATTERN,” “EXIT TUNER” or “EXIT MEM EDIT”) may appear, indicating that the selected function cannot be performed in the current condition. When this happens, simply follow the directions of the message and/or use the appropriate panel button (depending on the function currently selected) to return to the appropriate mode.

For example, if you are using the footswitch to enter and exit the Tuner mode, and press it while the MIDI Bulk Transmission function is active, the message “EXIT MIDI BULK” will appear. Either continue with the MIDI Bulk Transmission operation, or press one of the mode buttons on the panel to return to normal operation.

Using the External Footswitch as a Total Effect Bypass Switch (All Effects ON/OFF)

You can also use the external footswitch to turn all active effects on and off at once, as a total bypass switch.



This function is useful when you want to turn on or off ALL effects (not just the group-assigned effects) at once. It is also useful as a kind of “panic” switch in live performance, to turn off all effects if some kind of trouble (such as feedback) suddenly occurs.

Operation —

1. Simultaneously hold down the connected external footswitch and press [SHIFT].
2. Now, when you press the external footswitch, all currently active effects are turned on or off.

RESTORING FACTORY PRESET EFFECT PROGRAMS

If you’ve erased one of the factory effect programs by replacing it with one of your own creation, this function lets you restore the original program.

Operation —

1. Turn off the power of the GW50.
2. Simultaneously hold down [MEMORY] and turn the power back on. The MEMORY LED and the BANK/MEMORY indicator both flash. (“LD MEM” appears in the LCD.)
3. Select the number of the effect program you wish to restore with the [-]/[+] buttons.
4. Press [SET-B] (below “GO”) to restore the program, or press [SET-A] (below “EXIT”) to abort the operation. (You can also abort the operation by using any of the mode buttons: [MANUAL], [MEMORY], or [SONG/PATTERN].)



You can continue loading successive factory effect programs by repeating steps #3 and #4 above as necessary.



AVOID LOSING IMPORTANT DATA—Keep in mind that this operation automatically and irretrievably erases the program you created at the selected number. To avoid losing the program entirely, save it and others you have created by using the MIDI Bulk Transmission function. (See page 102.)

EFFECTS AND PARAMETERS

This section briefly explains each of the effect types and their parameters.

For information on how to select effects and edit the main and sub parameters, see the sections “Selecting an Effect Type,” “Editing Parameters” (page 44), “Selecting Effect Programs” (page 51) and the “MEMORY EDIT MODE” section (page 53).

Note: The characters that appear in parentheses after certain effect and parameter names in this section indicate those names as they appear in the LCD. For example, the title “WAH + EQ (WAH, WEQ)” indicates that either WAH or WEQ are shown in the LCD.

COMPRESSOR

The Compressor block is especially effective for guitar since it smooths out the “peaks” and “valleys” in the sound. Compression “squashes” the dynamic range of the signal, making loud signals softer and soft signals louder. Normally, the Compressor should be put before the other effect blocks since it limits signals of widely varying loudness to a dynamic range more suitable for use with the other effects. For this reason, compression is also effective on guitar in smoothing out the level differences caused by uneven picking technique.

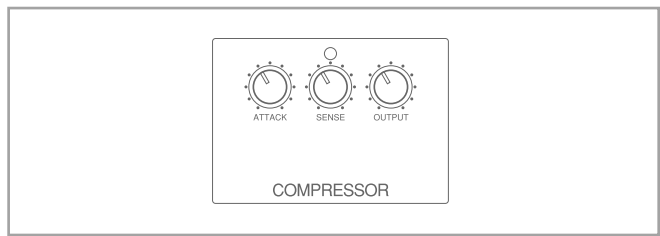

ATTACK — Range: 1 ~ 14

Determines the amount of time it takes for compression to begin after an input signal is detected. Longer attack times (higher values) let through more of the natural attack of the input signal.

SENSE — Range: -6 ~ -42 dB

Determines the threshold level of compression. Compression is applied to signal levels above the Sense point, while signals below this point are unaffected.

OUTPUT — Range: 0 ~ 200%

Determines the level of the processed sound. Settings above 100% are used for boosting the overall signal to an appropriate level, since compression effectively lowers the level of the sound.



SETTING THE OUTPUT PARAMETER—In general — for this effect and others — set the Output parameter so that the level of the sound is constant, even when switching the effect on and off. If the Output parameter (and the Input parameter on other effects) are set too high or low, you may get unwanted sudden jumps in the level of the sound when turning the effects on and off, sometimes resulting in overloading of subsequent effects.

DISTORTION

The Distortion block features five different distortion effects, some of which recreate the same warm distortion as that of a tube amplifier. Dist 1 is a general-purpose distortion sound, Dist 2 provides a warm, tube amplifier sound, Dist 3 has a hard “edgy” sound, Dist 4 provides a heavy, “fat” distortion effect, while the Overdrive effect provides a sound like the natural overdrive produced by a guitar amp.

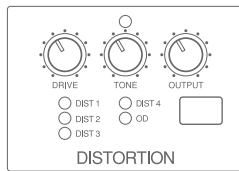

DIST 1–4, OD (Overdrive)

DRIVE — Range: 0 ~ 100%

Determines the intensity of the distortion or overdrive sound. The higher the value, the greater the distortion.



For best results, set the Drive parameter to roughly 25%–60%.

TONE — Range: –16 ~ +16

Determines the total quality of the distortion sound. Negative values cut the high frequencies for a “fatter” sound, while positive values boost the high frequencies for a brighter sound.

OUTPUT — Range: 0 ~ 100%

Determines the output level of the processed sound.

Note: SETTING THE OUTPUT PARAMETER—In order to avoid sudden jumps in level when changing between effect programs, or to avoid overloading subsequent effects within an effect program, the Output parameter should be set to an appropriate value — a value at which the level difference is small or nonexistent when switching the effect on and off.

EQUALIZER

The Equalizer block features a parametric equalizer, wah (or filter sweep) effect, and an amp simulator that effectively reproduces the sound of a guitar amp and speaker cabinet.

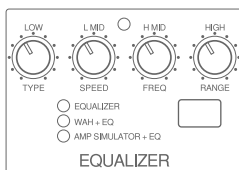

Note: SETTING THE INPUT AND OUTPUT PARAMETERS—For each of the Equalizer types below, the Input parameter should be set to an appropriate value to avoid overloading of this and subsequent effects. Also, the Output parameter should be set appropriately to avoid sudden jumps in level when changing between effect programs, or to avoid overloading subsequent effects within an effect program. (See Note in the Distortion section, above.)

Note: When the Wah + EQ effect or Amp Simulator +EQ effect is placed before Distortion (in CONNECT), the EQ portion of the effect is actually applied AFTER Distortion.

Equalizer (EQ)

The Equalizer effect is a highly versatile and flexible four-band parametric equalizer that includes bandwidth (Q) controls on the Lo Mid and Hi Mid frequencies.

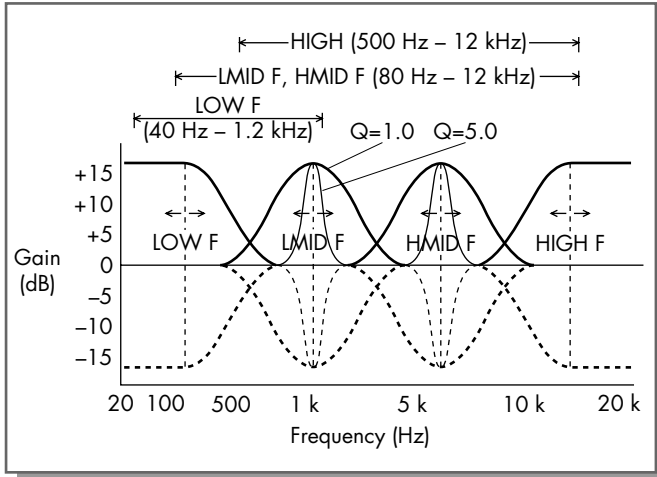

LOW — Range: -15 ~ +15 dB

Determines the amount of boost or cut applied to the low frequencies (as set in Low Frequency below).

LOW MID (L MID) — Range: -15 ~ +15 dB

Determines the amount of boost or cut applied to the low-midrange frequencies (as set in Low Mid Frequency below).

HIGH MID (H MID) — Range: -15 ~ +15 dB

Determines the amount of boost or cut applied to the high-midrange frequencies (as set in High Mid Frequency below).

HIGH — Range: -15 ~ +15 dB

Determines the amount of boost or cut applied to the high frequencies (as set in High Frequency below).

Sub parameters:

INPUT — Range: 0 ~ 100%

Determines the level of the input signal. Normally, this should be set to 100%; however, if equalizer adjustments have been made that bring the overall signal level up, lower values can be used here to compensate to reduce the volume to an appropriate level.

LOW FREQUENCY (LOW F) —

Range: 40 Hz ~ 1.2 kHz

Determines the cutoff frequency of the low frequency band (as adjusted in Low above).

LOW MID FREQUENCY (LMID F) —

Range: 80 Hz ~ 12.0 kHz

Determines the central frequency of the low-midrange frequency band (as adjusted in Low Mid above).

HIGH MID FREQUENCY (HMID F) —

Range: 80 Hz ~ 12.0 kHz

Determines the central frequency of the high-midrange frequency band (as adjusted in High Mid above).

HIGH FREQUENCY (HIGH F) —

Range: 500 Hz ~ 12.0 kHz

Determines the cutoff frequency of the high frequency band (as adjusted in High above).

LOW MID Q (LMID Q) — Range: 0.1 ~ 5.0

Determines the bandwidth or range of the low-midrange frequencies (adjusted in Low Mid above). The higher the value, the greater the range of frequencies affected.

HIGH MID Q (HMID Q) — Range: 0.1 ~ 5.0

Determines the bandwidth or range of the high-midrange frequencies (adjusted in High Mid above). The higher the value, the greater the range of frequencies affected.

OUTPUT — Range: 0 ~ 200%

Determines the level of the processed sound. Settings above 100% are used for boosting the signal to an appropriate level to compensate for equalizer adjustments that bring the overall signal level down.

WAH + EQ (WAH, WEQ)

Wah is a filter sweep effect that, as its name implies, produces a “wah” type sound. The sweep of the filter can be made to vary automatically, or it can be controlled by the input level or with a connected external foot controller. A separate two-band parametric equalizer is included after the wah effect and can be adjusted with the sub parameters.

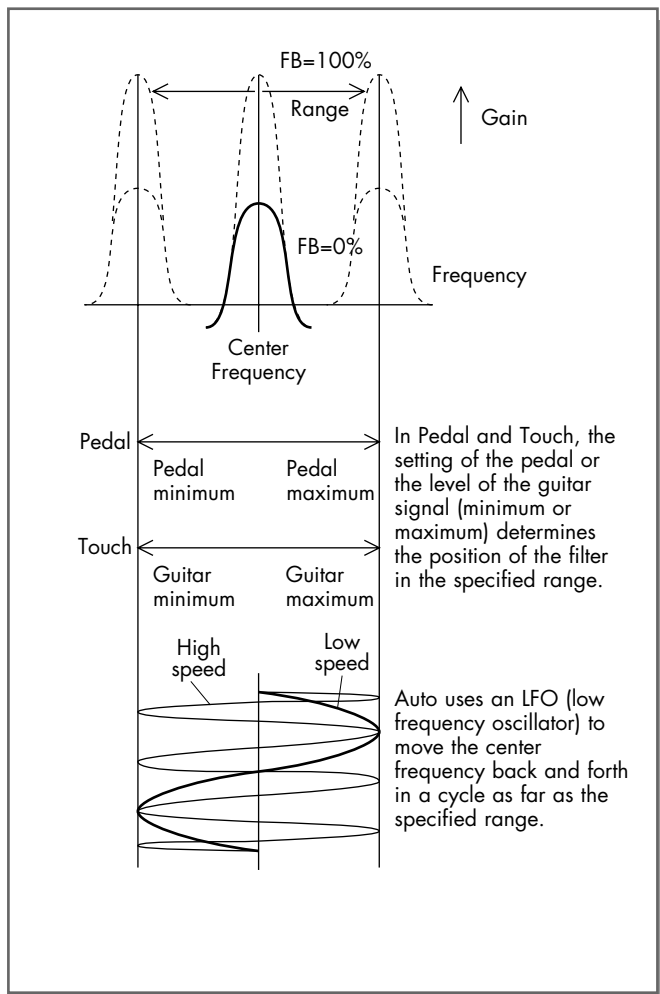

TYPE — Settings: Touch Slow (TOUCH SLW), Touch Fast (TOUCH FST), Auto, Pedal (Wah Pedal operation only; see page 47).

The Touch settings let you control the Wah effect by the level of the input signal (or how hard you play). The filter sweep (or “wah” sound) starts at the beginning each time it is triggered. Touch Slow creates a slow single sweep down, while Touch Fast has a fast single sweep down.

The Auto setting creates a repeating sweep cycle that runs freely, independent of the input signal; the speed of this cycle can also be adjusted.

The Pedal setting lets you sweep the filter manually with a connected foot controller. This setting is available only when WAH PEDAL operation has been selected for the external foot controller; also, Touch Slow, Touch Fast and Auto cannot be selected when the foot controller has been assigned to WAH PEDAL operation. (Refer to the section “SETTING THE FUNCTION OF THE EXTERNAL FOOT CONTROLLER — FOOT,” page 47, for more information on WAH PEDAL operation.)

SENSE (controlled with the second knob from the left, when Touch Slow or Touch Fast are selected) — **Range: 1 ~ 10**

The higher the value, the more sensitive the trigger of the Wah effect is to low level signals.

Note: The second knob from the left controls different parameters, depending on the selected type.



Touch Slow } Sense
Touch Fast }
Auto → Speed
Pedal → (No parameter)



For best results, when playing a solo or a line, try setting Sense to a high value; when performing backing or rhythm parts, try setting Sense to a low value.

SPEED (controlled with the second knob from the left, when Auto is selected) —

Range: 0.4 ~ 6.4 Hz

Determines the speed of the filter sweep cycle.

CENTER FREQUENCY (CENTER) —

Range: 125 Hz ~ 9.0 kHz

Determines the center frequency of the Wah effect. The emphasized frequency is swept around this frequency.

RANGE — **Range: 0 ~ 28**

Determines the width of the center frequency, or how far the sweep extends above and below the center frequency. (See illustration above.)

Sub parameters:

FEEDBACK (FB) — **Range: 0 ~ 100%**

Determines the amount of the Wah-processed signal that is fed back to the Wah input. Higher values result in a stronger Wah sound.

EQ INPUT — **Range: 0 ~ 100%**

Determines the level of the input signal. Normally, this should be set to 100%; however, if equalizer adjustments have been made that bring the overall signal level up, lower values can be used here to compensate to reduce the volume to an appropriate level.

EQ LOW — **Range: -15 ~ +15 dB**

Determines the amount of boost or cut applied to the low frequencies (as set in Low Frequency below).

EQ LOW FREQUENCY (LOW F) —

Range: 40 Hz ~ 1.2 kHz

Determines the cutoff frequency of the low frequency band (as adjusted in Low above).

EQ HIGH — **Range: -15 ~ +15 dB**

Determines the amount of boost or cut applied to the high frequencies (as set in High Frequency below).

EQ HIGH FREQUENCY (HIGH F) —

Range: 500 Hz ~ 12.0 kHz

Determines the cutoff frequency of the high frequency band (as adjusted in High above).

EQ OUTPUT — **Range: 0 ~ 200%**

Determines the level of the processed sound. Settings above 100% are used for boosting the signal to an appropriate level to compensate for equalizer adjustments that bring the overall signal level down.

Amp Simulator + EQ (AEQ)

This effect realistically reproduces the characteristic sound of a guitar amplifier, and provides a natural sound for direct recording purposes when not using an external amplifier. A separate two-band parametric equalizer is included after the Amp Simulator effect.

TYPE — **Settings: Stack, Combo, Tube**

Determines the type of amplifier that is simulated. Stack recreates the powerful sound of a huge amp/speaker setup, Combo recreates a compact amp cabinet, and Tube recreates the warm sound of a tube amplifier.

EQ LOW — **Range: -15 ~ +15 dB**

Determines the amount of boost or cut applied to the low frequencies (as set in Low Frequency below).

Note: This parameter is for adjusting the low gain of the two-band EQ, which is independent of the Amp Simulator effect.

EQ HIGH — **Range: -15 ~ +15 dB**

Determines the amount of boost or cut applied to the high frequencies (as set in High Frequency below).

Note: This parameter is for adjusting the high gain of the two-band EQ, which is independent of the Amp Simulator effect.

MIX BALANCE (MIX) — Range: 0 ~ 100%

Determines the balance between the dry (direct) and processed signals. A setting of 0% outputs only the dry signal, and a setting of 100% outputs only the processed sound.

Sub parameters:

EQ INPUT — Range: 0 ~ 100%

Determines the level of the input signal. Normally, this should be set to 100%; however, if equalizer adjustments have been made that bring the overall signal level up, lower values can be used here to compensate to reduce the volume to an appropriate level.

EQ LOW FREQUENCY (LOW F) —

Range: 40 Hz ~ 1.2 kHz

Determines the cutoff frequency of the low frequency band (as adjusted in Low above).

EQ HIGH FREQUENCY (HIGH F) —

Range: 500 Hz ~ 12.0 kHz

Determines the cutoff frequency of the high frequency band (as adjusted in High above).

EQ OUTPUT — Range: 0 ~ 200%

Determines the level of the processed sound. Settings above 100% are used for boosting the signal to an appropriate level to compensate for equalizer adjustments that bring the overall signal level down.



ENHANCING THE AMP SIMULATOR—

By judicious use of the Pitch Shift effect (see the Amp Simulation settings in the table on page 65), you can create a richer, more natural amplifier simulation.

CHORUS

The Chorus block features a wide range of pitch change and modulation effects, including Chorus, Flanger and Phaser. Chorus uses modulation of the pitch and volume to enhance the sound by generally making it richer and fatter.

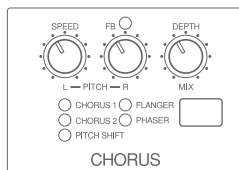

Note: For each of the Chorus types below, the MIX and DRY parameters should be set appropriately to avoid sudden jumps in level when changing between effect programs, or to avoid overloading subsequent effects within an effect program. (See Note in the Distortion section, page 59.) Also, when MIX and DRY are both set to 0, no sound is output.

Chorus 1, 2 (CH1, CH2)

Two chorus effects are provided: Chorus 1 features both pitch and volume modulation for an animated sound, while Chorus 2 provides a richer, more spacious effect.

SPEED — **Range: 0.03 ~ 6.18 Hz**

Determines the speed of the pitch modulation.

BRILLIANCE (BRIL)

(controlled with the center knob) —

Range: -3 ~ +6 dB

This functions as a tone control, for adjusting the brightness of the chorus sound.

DEPTH — **Range: 0 ~ 100%**

Determines the depth of the pitch modulation, or how widely the pitch is varied.

Sub parameters:

EFFECT MIX (MIX) — **Range: 0 ~ 100%**

Determines the level of the processed signals. A setting of 0% results in no effect output. Use this control with the Dry Level (DRY) parameter below to determine the balance between the effect and dry (direct) sound.

AMD (Chorus 1 only) — **Range: 0 ~ 100%**

AMD (Amplitude Modulation Depth) varies the volume instead of the pitch, creating a tremolo effect along with the chorus.

DRY LEVEL (DRY) — **Range: 0 ~ 100%**

Determines the level of the dry (direct) sound. A setting of 0% results in no direct sound output. Use this control with the Effect Mix (MIX) parameter above to determine the balance between the effect and dry sound.

Pitch Shift (P.L, P.R, P.S)

Pitch Shift lets you change the pitch of the sound, up to an octave above or below normal pitch. Since the amount of pitch shift can be set independently for the left and right channels, three separate pitches (including the original direct signal) can be heard. One application for this would be to create a natural yet complex chorus effect in which the left and right pitches are detuned slightly relative to the direct sound. Other applications include setting the pitch shift to an octave below or above (to make a six-string guitar sound like a twelve-string), or setting the pitch to other intervals (such as a fourth or fifth) to create instant harmonies and fill out the sound..

PITCH LEFT (LEFT) —

Range: -1200 ~ +1200 cents

Determines the amount of pitch shift for the left channel, up to one octave above or below the input pitch. Fine pitch shift values can be set in 5-cent steps up to +/-200 cents; 100 cents is equivalent to a half step or semitone.

PITCH RIGHT (RIGHT) —

Range: -1200 ~ +1200 cents

Determines the amount of pitch shift for the right channel, up to one octave above or below the input pitch.

EFFECT MIX (MIX) — **Range: 0 ~ 100%**

Determines the level of the processed signals. A setting of 0% results in no effect output. Use this control with the Dry Level (DRY) parameter below to determine the balance between the effect and dry sound.

Sub parameters:

LEFT DELAY TIME (DL TIM, P.L) —

Range: 0.1 ~ 10 ms

Determines the time that the left pitch-shifted signal is delayed.

LEFT DELAY FEEDBACK (DL FB, P.L) —**Range: 0 ~ 99%**

Determines the amount of regeneration of the left signal's delayed repeats. The higher the value, the greater the number of repeats. Since the pitch shift is applied to each delayed repeat, each successive repeat has a different pitch.

RIGHT DELAY TIME (DL TIM, P R)**Range: 0.1 ~ 10 ms**

Determines the time that the right pitch-shifted signal is delayed.

RIGHT DELAY FEEDBACK (DL FB, P R)—**Range: 0 ~ 99%**

Determines the amount of regeneration of the right signal's delayed repeats. The higher the value, the greater the number of repeats. Since the pitch shift is applied to each delayed repeat, each successive repeat has a different pitch.

DRY LEVEL (DRY, P.S) — Range: 0 ~ 100%

Determines the level of the dry sound. A setting of 0% results in no direct sound output. Use this control with the Effect Mix (MIX) parameter above below to determine the balance between the effect and dry sound.



Pitch Shift is capable of creating a wide range of effects — from subtle “fattening” of the sound to wild, special effects. To get you started exploring some of the possibilities, here are some suggested settings.

	Detuning	Harmony	Amp Simulation
Pitch Left	-5 ~ -25 cents	-100 ~ -1200 cents (-1200 = -1 octave)	0 cents
Pitch Right	+5 ~ +25 cents	+100 ~ +1200 cents (+1200 = +1 octave)	0 cents
Effect Mix	50%	50%	50%
DL TIM, P.L	10ms	10ms	0.1~2ms
DL FB, P.L	0%	0%	0%
DL TIM, P.R	10ms	10ms	0.1~2ms
DL FB, P.R	0%	0%	0%
DRY	50%	50%	100%

The detuning settings create a soft, natural chorus effect, while the harmony settings provide a completely separate pitch, enabling two- or three-part harmonies. With the octave and harmony settings in particular, try increasing the Left and Right Delay Feedback values to create interesting special effects like stacked harmonies.

Flanger (FL)

Flanger is used to enhance the sound with modulation, creating an animated, swirling motion effect. It is effective in emphasizing the metallic sound of a guitar. This is a stereo flanging effect that lets you set separate left and right delay times.

SPEED — Range: 0.03 ~ 6.18 Hz

Determines the speed of the pitch modulation.

FEEDBACK (FB) — Range: 0 ~ 100%

Determines the amount of the Flanger-processed signal that is fed back to the Flanger input. Higher values result in a stronger Flanger sound.

DEPTH — Range: 0 ~ 100%

Determines the depth of the pitch modulation, or how widely the pitch is varied.

Sub parameters:**EFFECT MIX (MIX) — Range: 0 ~ 100%**

Determines the level of the processed signals. A setting of 0% results in no effect output. Use this control with the Dry Level (DRY) parameter below to determine the balance between the effect and dry sound.

LEFT DELAY TIME (L TIME) —**Range: 0.1 ~ 12.0 ms**

Determines the time that the signal is delayed before applying the flanger to the left channel.

RIGHT DELAY TIME (R TIME) —**Range: 0.1 ~ 12.0 ms**

Determines the time that the signal is delayed before applying the flanger to the right channel.

DRY LEVEL (DRY) — Range: 0 ~ 100%

Determines the level of the dry sound. A setting of 0% results in no direct sound output. Use this control with the Effect Mix (MIX) parameter above below to determine the balance between the effect and dry sound.

Phaser (PH)

Phaser is a strong and pronounced modulation effect.

SPEED — Range: 0.03 ~ 6.18 Hz

Determines the speed of the phase modulation.

FEEDBACK (FB) — Range: 0 ~ 100%

Determines the amount of the Phaser-processed signal that is fed back to the Phaser input. Higher values result in a stronger Phaser sound.

DEPTH — Range: 0 ~ 100%

Determines the depth of the phase modulation.

Sub parameters:**EFFECT MIX (MIX) — Range: 0 ~ 100%**

Determines the level of the processed signals. A setting of 0% results in no effect output. Use this control with the Dry Level (DRY) parameter below to determine the balance between the effect and dry sound.

DRY LEVEL (DRY) — Range: 0 ~ 100%

Determines the level of the dry sound. A setting of 0% results in no direct sound output. Use this control with the Effect Mix (MIX) parameter above below to determine the balance between the effect and dry sound.

REVERB/DELAY

The Reverb/Delay block provides a reverb effect, a delay effect, and a delay combined with reverb. Used judiciously, reverb is one of the most important effects, since without it the sound is generally flat, dry and unnatural. Putting reverb on a guitar is an effective way to bring the sound to life and make it sound more natural. Delay, although more of a special effect, also helps in creating a sense of space and depth in the sound. Generally, delay and/or reverb effects are best used as the last effect in the chain, since they reproduce the echoes and ambience that follow a sound when heard in an actual performance environment.

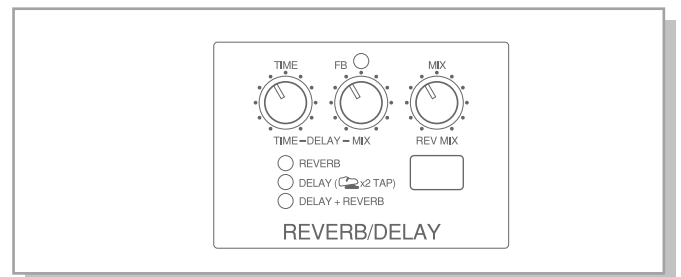

Note: SETTING THE MIX AND DRY PARAMETERS—For each of the Reverb/Delay types below, the MIX and DRY parameters should be set appropriately to avoid sudden jumps in level when changing between effect programs, or to avoid overloading subsequent effects within an effect program. (See Note in the Distortion section, page 59.) Also, when MIX and DRY are both set to 0, no sound is output.

Reverb (REV)

This is a high-quality, yet simple and easy-to-use Reverb effect that provides three reverb types and lets you create long reverbs of up to 10 seconds.

TIME — Range: 0.3 ~ 10.0 sec

Determines the time it takes for the reverberation to decay. Higher values create a larger apparent room size.

HIGH (controlled with the center knob) —

Range: 0.1 ~ 1.0

Determines the amount of high frequencies in the reverb sound. In other words, it is similar to a tone control, except that it affects only the reverberation, not the original signal. The higher the value, the greater the amount of high frequencies. Higher settings make the apparent room sound more reflective and “live,” while lower settings help to keep the sound from becoming too harsh or metallic.

EFFECT MIX (MIX) — Range: 0 ~ 100%

Determines the level of the processed signals. A setting of 0% results in no effect output. Use this control with the Dry Level (DRY) parameter below to determine the balance between the effect and dry sound.

Sub parameters:**TYPE — Settings: Hall, Room, Plate**

Determines the type of reverb. Use this to set the kind of acoustic environment you wish to reproduce. Hall simulates the ambience of large enclosed spaces, such as concert halls, auditoriums and stadiums. Room simulates smaller performance spaces and various types of rooms. Plate recreates the special characteristics of a plate reverb, and is particularly effective at enhancing and filling out solo sounds.

LOW — Range: -3 ~ +6 dB

Determines the amount of low frequencies in the reverb sound. The higher the value, the greater the amount of low frequencies.

DRY LEVEL (DRY) — Range: 0 ~ 100%

Determines the level of the dry sound. A setting of 0% results in no direct sound output. Use this control with the Effect Mix (MIX) parameter above below to determine the balance between the effect and dry sound.

Delay (DLY)

Delay adds echoed repeats to the sound. This delay effect is a sophisticated multiple delay, with a main delay and an additional short “doubling” delay. The main delay time also has a tap delay function that lets you “play” the delay time, setting it in time with the rhythm you’re playing by tapping the Pedal Switch. The Tap Delay function can also be used to temporarily change the delay time of effect programs in the Memory mode (for those programs that have Delay).

TIME — Range: 7 ~ 896 ms

Determines the time between delayed repeats of the main delay. Very short delays (7–50 ms) have a doubling effect, making one instrument sound like two. Slightly longer delays (roughly 60–150 ms) can be used for creating slap-back echo or a reverb-type effect. Longer times are used for special effects.

To use the Tap Delay function, press the Pedal Switch of the Delay block twice, when Delay is on. (If Delay has not been selected, pressing the Pedal Switch for tap delay will not set the delay time, but will simply turn the effect on and off.) The GW50 automatically sets the delay time to match the time between presses of the Pedal Switch.

Note: The Tap Delay function can be used in the Manual, Memory or Memory Edit modes, if the MEMORY ON/OFF function is selected in the ASSIGNABLE Block (the MEMORY LED flashes).

Note: If you tap the Pedal Switch a little beyond the maximum time (up to about one second), the delay time will be set to the maximum value (896 ms). However, taps made much longer than one second will not set the delay time.

Note: The time set by Tap Delay is not saved as part of the program data; only the delay time set by the panel knob can be saved.



QUANTIZE FUNCTION ON TAP DELAY—The GW50 has a convenient “quantize” function that works with the backing rhythm patterns to keep your tap delay settings in time with the rhythm. This function measures the delay time that you tap with the Pedal Switch, and adjusts the time (if necessary) to synchronize the delay with the tempo of the rhythm pattern that is playing.

FEEDBACK (FB) — **Range: 0 ~ 100%**

Determines the number of the delayed repeats. Values close to 0 repeat the delay once or twice, while for higher values the repeats carry on almost indefinitely.

EFFECT MIX (MIX) — **Range: 0 ~ 100%**

Determines the level of the processed signals. A setting of 0% results in no effect output. Use this control with the Dry Level (DRY) parameter below to determine the balance between the effect and dry sound.

Sub parameters:

DOUBLING TIME (DB TIM) —

Range: 30 ~ 50 ms

Determines the time between delayed repeats of the short (or doubling) delay.

DOUBLING BALANCE (DB BAL) —

Range: 0 ~ 100%

Determines the level of the short (or doubling) delay. A setting of 0% outputs only the main delay, while a setting of 100% outputs only the short (or doubling) delay.

DRY LEVEL (DRY) — **Range: 0 ~ 100%**

Determines the level of the dry sound. A setting of 0% results in no direct sound output. Use this control with the Effect Mix (MIX) parameter above below to determine the balance between the effect and dry sound.

Delay + Reverb (D+R)

This effect combines both the Delay and Reverb effects above in one program. All parameters in the two effects are available in this program. (For parameter descriptions, refer to the Delay and Reverb effects above.)

DELAY TIME (DL TIM) —

Range: 4 ~ 512 ms

DELAY EFFECT MIX (DL MIX) —

Range: 0 ~ 100%

REVERB EFFECT MIX (RV MIX) —

Range: 0 ~ 100%

Sub parameters:

DELAY FEEDBACK (DL FB) —

Range: 0 ~ 100%

DOUBLING TIME (DB TIM) —

Range: 30 ~ 50 ms

DOUBLING BALANCE (DB BAL) —

Range: 0 ~ 100%

DELAY DRY LEVEL (DL DRY) —

Range: 0 ~ 100%

REVERB TYPE (RV TYP) —
Settings: Hall, Room, Plate

REVERB TIME (RV TIM) —
Range: 0.3 ~ 10.0 sec

REVERB LOW (RV LOW) —
Range: -3 ~ +6 dB

REVERB HIGH (RV HI) — **Range: 0.1 ~ 1.0**

REVERB DRY LEVEL (RV DRY) —
Range: 0 ~ 100%

NOISE GATE

Noise Gate is a separate effect that is placed before the Chorus and Reverb/Delay effects, and is used to eliminate any noise or hum in the signal when the instrument isn't being played. All signals below the Threshold point are filtered out, thus cutting off the noise. Noise Gate is always active no matter what the effect program or configuration.

Note: The Noise Gate cannot be used to eliminate any noise occurring after the Chorus or Reverb/Delay effects.

Operation —

1. From the Manual or Memory Edit mode, simultaneously hold down [SHIFT] and press [SUB PARAM]. This calls up the sub parameters. If "N.GATE" is not displayed here, press [CMP] or [DST] (or simultaneously hold down [SHIFT] and repeatedly press [SUB PARAM]).
2. Adjust with [-]/[+] buttons.
3. Exit this operation by pressing any of the mode buttons ([MANUAL], [MEMORY] or [SONG/PATTERN]).

Parameter

THRESHOLD — **Range: 0 ~ 9**

Determines the sensitivity of the noise gate, or how loud an input signal is required to open the gate (letting the signal through). The higher the value, the louder the signal needs to be to open the gate. For optimum operation, Threshold should be set just above the level of the noise; setting it too high may cause notes to be cut off too abruptly.

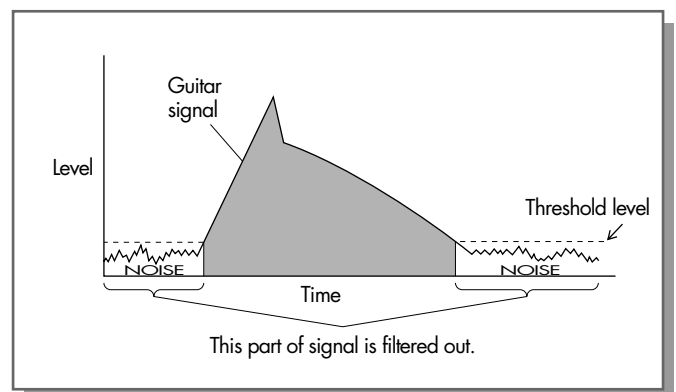



GW50

REFERENCE

BACKING SECTION

PATTERN MODE	73	RECORDING AND EDITING SONGS	83
Selecting and Playing Patterns	73	REALTIME RECORDING MODE	
Cursor Control in Pattern Mode	74	(REALTIME RECORDING)	83
Changing Chords	74	ASSIGNABLE Block and Pedal Switch	
Changing the Tempo	76	Functions in Song Realtime Recording	86
Muting the Accompaniment, Bass and		Hints on Realtime Recording	87
Drums	76	STEP RECORDING MODE	
ASSIGNABLE Block and Pedal Switch		(STEP RECORDING)	88
Functions in Pattern Mode	77	SONG EDIT MODE (SONG EDITING)	90
Backing Control	77	Viewing Recorded Events	90
Chord Recall	77	Editing (Changing) Recorded Events	92
Root Select	78	Erasing Recorded Events	92
SONG MODE	79	Set A and Set B Operations	92
SONG PLAY MODE		Marking Measure A and Measure B	92
(SONG PLAYBACK)	79	Jumping to Measure A or Measure B	92
Selecting and Playing Songs	79	Loop (Repeat) Playback (A to B)	92
Cursor Control in Song Mode	80	Loop (Repeat) Recording (A to B)	93
Changing the Tempo	80	SONG JOB MODE	94
Muting the Accompaniment, Bass and		Copying Measures Between A and B	94
Drums	80	Deleting Measures Between A and B	94
Position Controls	81	Naming Songs	95
ASSIGNABLE Block and Pedal Switch		RESTORING FACTORY PRESET SONGS ...	95
Functions in Song Mode	82		
Backing Control —			
Selecting and Playing a Song	82		
Triggered Run	82		



PATTERN MODE

In the Pattern mode, you can select and play rhythm and accompaniment patterns. There are 248 preset patterns covering a wide variety of musical styles, and they feature realistic drum, bass and other accompaniment sounds. Combined with the sophisticated chord controls of the GW50, these preset patterns provide easy-to-use backing tracks for performing along with.

Note: Unless indicated otherwise, all operations in the Pattern mode covered below can be performed either while the pattern is stopped or being played.



PATTERN TYPES—The patterns can be roughly divided into groups of four types, each designed to fill a specific role in a song. The types are indicated by the last one or two characters in the pattern name:

- ...A — Basic pattern, used generally for the “A” part of a song, such as the verse.
- ...AF — Fill in based on the basic pattern.
- ...B — Variation pattern, used generally for the “B” part of a song, such as the bridge or chorus.
- ...BF — Fill in based on the variation pattern.

To select the Pattern mode, press [**SONG/PATTERN**] so that the **PATTERN LED** lights. (The current pattern name appears in the display.)



The operations covered in this section on the Pattern mode pertain specifically to the Pattern mode. Make sure that the Pattern mode has been selected before trying each operation.

Selecting and Playing Patterns

Operation —

1. Using [**6 CURSOR**], move the arrow in the display to the **PTN** (Pattern) box.

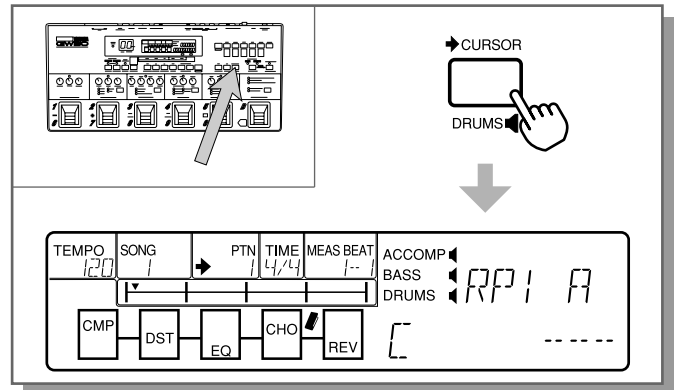

2. Use the [**-**]/[**+**] buttons to select the desired pattern number. (Refer to pages 144 and 145 for a list of the available patterns and their descriptions.)

Note: Only the odd number patterns from 1 – 239 (the basic patterns) can be selected here in the Pattern mode. Fill in patterns (even numbered patterns from 2 – 240) cannot be selected here; however, once a basic pattern has started, the companion fill in pattern for that basic pattern can be played by pressing Pedal Switch 3. (See page 77 for details.) Patterns 241 – 248, which include the special Retrigger, Ending, Metronome and Blank patterns, can all be selected.

3. To play the selected pattern, press [**START/STOP**].

Position indicator — Displays the current position in the measure (in 16th notes); moves when pattern is playing.

Pattern tempo

Time signature of the pattern

Backing mute status

TEMPO: 120 SONG: 1 PTN: 3 TIME: 4/4 MEAS BEAT: 1 ACCOMP: BASS DRUMS: F#

CMP DST EQ CHO REV

Beat 1 Beat 2 Beat 3 Beat 4

Current chord

Pattern name

Measure/Beat — This changes as the pattern in playing; the indication depends on the length of the pattern and its time signature.

Pattern number — This display title ("PTN") changes briefly to "NEXT PTN" if a second pattern is selected while the first is still playing. (The second pattern begins from the next measure, and the title changes back as well.)

START/STOP [] This flashes on every beat in time with the tempo.

Cursor Control in Pattern Mode

Whether a pattern is playing or not, the cursor arrow can be moved (using [6 CURSOR]) among the TEMPO and PTN sections of the Backing mode display, and the Effect mode display. (The cursor arrow actually disappears from the LCD when the Effect mode display is selected.)

Changing Chords

The GW50 features a sophisticated automatic bass and accompaniment function that automatically and instantly adds matching bass lines and chord voicings according to the chords you specify here. A total of 25 different chord types are available for each of the 12 keys.

In addition to the methods described below, the Pedal Switches can be used to assign chords to the Pedal Switches and change to pre-assigned chords. See the section "Chord Recall," page 77, for details.

Changing the Root Note

Operation — To change the root note of the chord, press the Chord button corresponding to the desired note (written above the button). Press it repeatedly until the desired note is shown in the LCD.

Note: The mark "#" in the LCD is used to represent "sharp."

Note: For this, and all other note/chord select operations, the Chord buttons "remember" the last selection made. For example, if you've selected "E" as the root note by pressing [D/E^bE] three times, and press another Chord button, you will need to press [D/E^bE] only once to call up "E."

Note: If the cursor arrow has been moved, "MANUAL" or the current effect program name may be displayed instead of the pattern name and current chord. (This is the Effect mode display.) To restore the Backing mode display shown above, press [6 CURSOR]. (See Cursor Control in Pattern Mode below for details.)

- To stop the pattern, press [START/STOP] again.

You can also use the Pedal Switches to select and play patterns; see page 12 for more information.

Changing the Chord Type

Operation —

To change the chord type, simultaneously hold [CHORD] and press the Chord button corresponding to the desired type (written below the button). Press it repeatedly until the desired chord type is shown in the LCD.

Changing the Bass Note of the Chord

This is used when you want to have the bass play a note other than the root. It is effective in adding harmonic complexity to transitions or in adding tension before resolving to the main chords of a progression.

Operation —

1. Simultaneously hold [CHORD] and press [on/ROOT].

Flashes (waiting for note entry).

2. Press the Chord button corresponding to the desired note (written above the button). Press it repeatedly until the desired note is shown in the LCD.

As long as the slash mark (/) in the display is flashing, different bass notes can be selected.

Optionally, if you want to change the root note of the chord here (yet keep the currently selected bass note), simultaneously hold [CHORD] and press [on/ROOT] again. (The slash mark stops flashing.) The selected bass note will continue to play even when you change to other root notes.

To switch between the two conditions below, simultaneously hold [CHORD] and press [on/ROOT].

In this condition, the bass note can be changed.

In this condition, the bass note is fixed and the root note of chord can be changed.

3. To cancel the selected bass note and have the bass line automatically change with the root note, hold [CHORD] and press one of the Chord buttons to reselect the chord type.

List of Chord Types

M	m	7	m7	M7
major	minor	seventh	minor seventh	major seventh
Madd9	madd9	9	m9	M9
major added ninth	minor added ninth	ninth	minor ninth	major ninth
sus4	m6	7+9	m7-11	7-9
suspended fourth	minor sixth	seventh sharp ninth	minor seventh flatted eleventh	seventh flatted ninth
7sus4	mM7	7+11	6	7-13
seventh suspended fourth	minor major seventh	seventh sharp eleventh	sixth	seventh flatted thirteenth
dim	m7-5	13	6.9	aug
diminished	minor seventh flatted fifth	thirteenth	sixth ninth	augmented

Note: A fingering chart for all these chords (in the key of C) is provided on page 152.

Changing the Tempo

Although each of the rhythm patterns has its own appropriately pre-programmed tempo, you can change this either before playing the pattern or while it is running.

Operation —

- Using [6 CURSOR], move the arrow in the display to the TEMPO box.

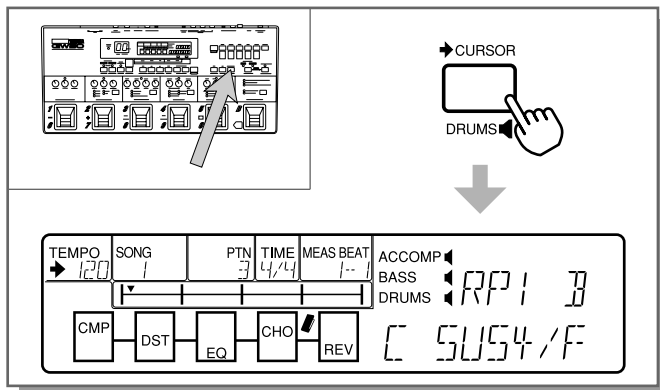

- Use the [-]/[+] buttons to adjust the tempo. (Hold down either button for rapid operation; see page 5.) The range is from 30 – 250 BPM (beats per minute).

Note: ABOUT TEMPO CHANGES AND PATTERN GROUPS—The tempo change you make here remains in effect as long as you stay within the A/B pattern “group.” For example, patterns 201 (JT2 A) and 203 (JT2 B), with their fill in patterns 202 and 204 comprise one such group. Any pattern you select within this group, including the companion fill in patterns, will stay at the same tempo. However, if you select a pattern from another group (for example, 205 — JT3 A), that new pattern will play at its default tempo. If you return to the first group again (for example, 203 — JT2 B), the tempo change you made before will be cancelled and the pattern will play at its default tempo.

Muting the Accompaniment, Bass and Drums

This function lets you turn the sound of the individual backing parts (accompaniment, bass and drums) on and off, either before starting a pattern or while it is playing.

Operation —

Simultaneously hold down [SHIFT] and press the appropriate button: [ACCOMP], [BASS] or [DRUMS].

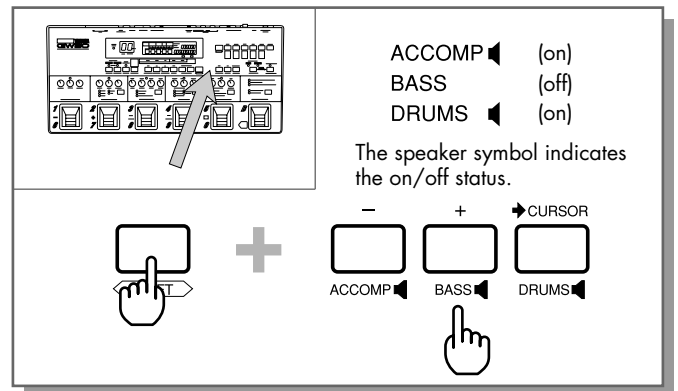



ASSIGNABLE Block and Pedal Switch Functions in Pattern Mode

The Pedal Switches can be used in the Pattern mode either to select and play patterns (Backing Control) or to change chords (Chord Recall).



USING ASSIGNABLE BLOCK PEDAL SWITCH TO SWITCH BETWEEN BACKING CONTROL AND CHORD RECALL—Although the Type switch in the ASSIGNABLE Block is normally used to select Backing Control and Chord Recall, you can use the ASSIGNABLE Block Pedal Switch in the Pattern mode to switch between the two, after either one has been selected.

Note: When pressing [SONG/PATTERN] to select the Pattern or Song mode, Backing Control will automatically be selected.

Backing Control

■ Selecting and Playing Patterns

Operation —

1. Use the ASSIGNABLE Block Type switch to select BACKING CONTROL. (The LED next to the function name lights.)
2. The Pedal Switches function as shown below. Press the appropriate Pedal Switch for the desired function.

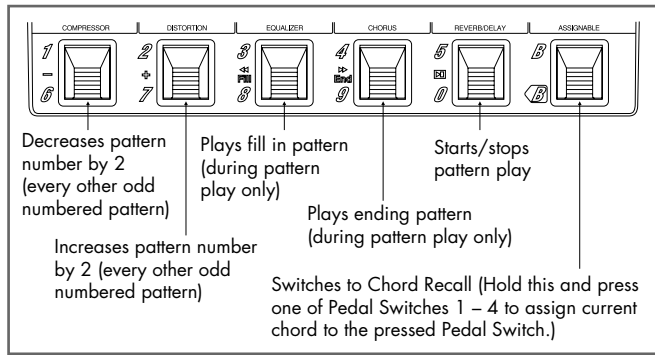

PLAYING FILL IN PATTERNS—You can use Pedal Switch 3 (Fill) to play the fill in pattern at any point in a measure. In other words, if you press the Pedal Switch on the third beat of a measure, the fill in pattern will playback from the third beat to the end of the measure and then will return to the normal pattern. Also, holding down the Fill Pedal Switch through successive measures continues playing the fill in pattern.

Note: If you press the Fill Pedal Switch on the last 16th note of a measure, the fill in pattern will play in its entirety from the next measure.



PLAYING AN ENDING PATTERN—Rather than simply stopping the pattern with [START/STOP], you can use Pedal Switch 4 (End) to play a simple ending pattern. Press it during the measure previous to the intended ending.

Chord Recall

■ Selecting Chords

Operation —

1. Use the ASSIGNABLE Block Type switch to select CHORD RECALL. (The LED next to the function name lights.)
2. The Pedal Switches function as shown below. Press the appropriate Pedal Switch for the desired function. Chords can be selected whether a pattern is playing or not.

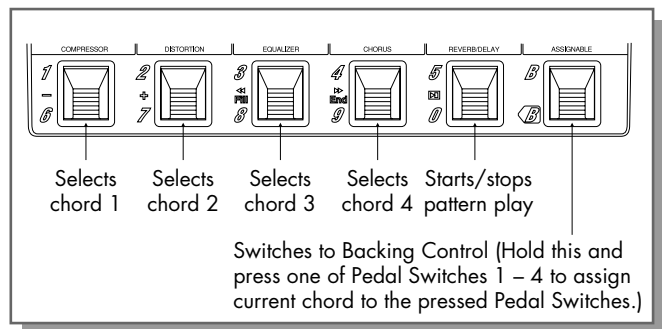

■ Assigning Chords to the Pedal Switches

Operation —

1. Select CHORD RECALL or BACKING CONTROL in the ASSIGNABLE block.
2. Select a chord root note, chord type and (if desired) a bass note by using the Chord buttons. (Refer to the instructions in the section “Changing Chords,” page 74.)
3. To assign the selected chord to a Pedal Switch, simultaneously hold down the ASSIGNABLE Block Pedal Switch and press one of the Pedal Switches 1 – 4. (Pedal Switch 5 is reserved for pattern start/stop.)

Note: Chords can be assigned whether a pattern is currently playing or not.

Root Select

Root Select lets you change the root note of the chord to the note you play on the connected instrument.

Operation —

1. Make sure that either BACKING CONTROL or CHORD RECALL have been selected in the ASSIGNABLE Block, then start the pattern.
2. Press and hold down the ASSIGNABLE Block Pedal Switch.

3. While holding down the Pedal Switch, play a note on the connected instrument. If you’ve played a note other than the root note of the chord currently playing, the root note will change to the note you just played.

The note you play on the instrument is muted and not output until you release the Pedal Switch. In this way you can hold down the Pedal Switch, play a note to change the root, then let up on the Pedal Switch and play along with the backing part as usual. (When this is done, CHORD RECALL is automatically selected in the ASSIGNABLE Block.)



For best results with Root Select, the connected instrument should be tuned properly. Use the Tuner function of the GW50 (see page 99) to tune the instrument.



Keep in mind that this function is not instantaneous; a short time is necessary for the GW50 to “hear” the pitch of the note and respond accordingly. Play around with this function to get a feel for the response time before you try using it in performance.



The GW50 detects and responds to high notes more quickly than low notes.



SONG MODE

In the Song modes, you can select and play preset songs. You can also use the sequencer functions to record and create your own songs.

To select the Song mode, press [SONG/PATTERN] so that the SONG LED lights. (The current song name briefly appears in the display.)



The operations covered in this section on the Song mode pertain specifically to the Song mode. Make sure that the Song mode has been selected before trying each operation.

SONG MODE (SONG PLAYBACK)

Selecting and Playing Songs

Operation —

- Using [6 CURSOR], move the arrow in the display to the SONG box.

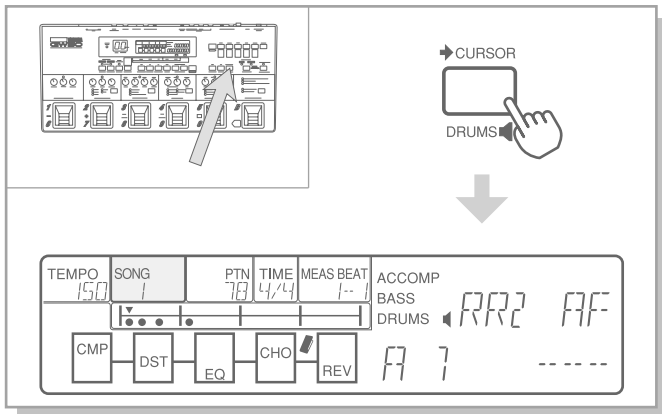

- Use the [-]/[+] buttons to select the desired song number. (Refer to page 147 for a list of the factory preset songs and their descriptions.)

The song name briefly appears in the LCD, and the song number briefly appears in the BANK/MEMORY indicator. (The song number is shown continuously in the SONG box in the LCD.)

- To play the selected song, press [START/STOP].

START/STOP

This flashes on every beat in time with the tempo.

Measure/Event section

- Pattern number
- Song tempo
- Song number
- Time signature of the current pattern
- Measure/Beat — Indicates the current position in the song.
- Backing mute status

TEMPO: 150 SONG: 1 PTN: 78 TIME: 4/4 MEAS: 1 BEAT: 1 ACCOMP: F F F F F F F F
BASS: F F F F F F F F
DRUMS: F F F F F F F F

CMP: DST: EQ: CHO: REV: F F 7 -----

Beat 1 Beat 2 Beat 3 Beat 4 Current chord

Position indicator — Displays current position in measure (in 16th notes); moves when song is playing.

Event indicator — Shows that an event or events (pattern number, chord change, effect program number, etc.) has been recorded at the marked position.

Note: If the cursor arrow has been moved, “MANUAL” or the current effect program name may be displayed instead of the pattern name and current chord. (This is the Effect mode display.) To restore the Backing mode display shown above, press [6 CURSOR]. (See “Cursor Control in Song Mode” below for details.)

Note: If many events (particularly those of effect program changes) have been recorded within a measure of a song, the position indicator may move jerkily through the measure. This only applies to the display; actual playback is unaffected.



A Repeat function (A-B Repeat) lets you repeatedly and continuously play a specified section of the song. (See page 92 for details.)

- 4.** To stop the song, press [START/STOP] again.

Note: ABOUT SONG STOP—If you let the song play to the end, it will stop automatically and return to the first measure. If you’ve stopped the song in the middle of playback, [START/STOP] functions like a pause button, alternately pausing and resuming playback from the paused point. To return to the first measure of the song, simultaneously press the [n] and [v] buttons.

Cursor Control in Song Mode

The cursor arrow can be moved (using [6 CURSOR]) among the various sections of the display as described below:

When a song is not playing —

The cursor arrow can be moved among the TEMPO, SONG and PTN sections of the Backing mode display, and the Effect mode display (“MANUAL” or the current effect program name). (The cursor arrow actually disappears from the LCD when the Effect mode display is selected.)

When a song is playing —

The cursor can only be moved between TEMPO and the Effect mode display.

Note: Although you can change the displayed chord and pattern number, this has no effect on song playback, since the GW50 returns to the originally programmed chord and pattern number before starting the song. For more information on entering these and other types of events, see STEP RECORDING, page 88.)

Changing the Tempo

You can change the tempo of a song, either before or during playback.

To change the tempo, simply use [6 CURSOR] to move the cursor arrow to TEMPO in the display, and adjust the tempo with the [-]/[+] buttons.

Note: The tempo change you make here is automatically saved as the tempo setting for the song, erasing the previous setting. (In other words, the last tempo setting made is the one that is in effect.)

Muting the Accompaniment, Bass and Drums

This function lets you turn the sound of the individual backing parts (accompaniment, bass and drums) on and off, either before starting a song (providing no muting events are at the start of the song) or while it is playing.

Note: If muting events have been entered in a song, the mute status will change accordingly during playback.

Operation —

Simultaneously hold down [SHIFT] and press the appropriate button: [ACCOMP], [BASS] or [DRUMS].

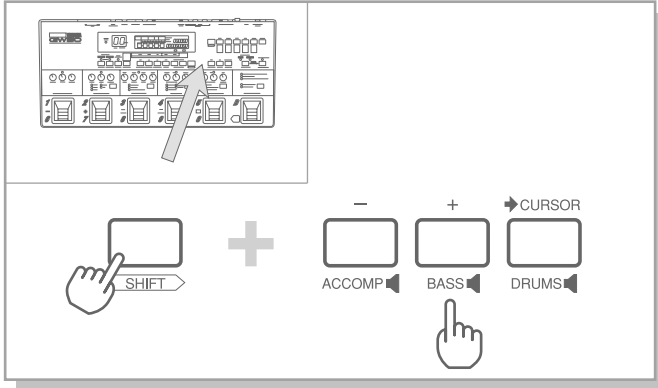

Position Controls

These are used to move the position indicator in the Measure/Event section of the display in Song play.

Reverse one measure. (Hold down for continuous rapid operation.)

Forward one 16th note. (Hold down for continuous rapid operation.)

Reverse one 16th note. (Hold down for continuous rapid operation.)

Forward one measure. (Hold down for continuous rapid operation.)

Simultaneously hold down [SHIFT] and press this to jump to measure B (first beat).

Set measure B.

Set measure A.

Simultaneously press these to jump to beginning of song (first beat of first measure).

Simultaneously press these to jump to end of song (last recorded event in song).

Simultaneously hold down [SHIFT] and press this to jump to measure A (first beat).

SONGNAME MEAS DEL MEAS COPY ERASE A-SET-B A-JUMP-B [SHIFT]

Note: USING POSITION CONTROLS DURING PLAYBACK—With the exception of the A-measure and B-measure controls, all the Position Controls above can also be used while the song is playing back. When using the [n] and [v] buttons to reverse during playback, hold down the appropriate button until the desired position is reached.

Note: USING POSITION CONTROLS TO VIEW RECORDED EVENTS—When you press any of the four main Position Controls ([n], [v], [/], or [m]), the currently active pattern number, mute status, pattern name, and chord appear in the display. (If the cursor arrow is in the Effect mode display — the cursor arrow disappears from the display — “MANUAL” or an effect program name appears instead of the pattern name and chord.) To restore the Backing mode display, press [-> CURSOR].

In the example display shown below, no event has been recorded to the current position:

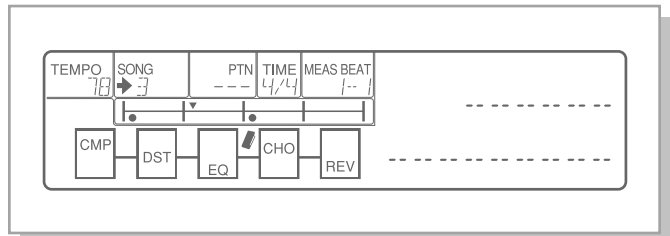

When you press [/] to move to the next 16th note, even if that 16th note also has no event, the display shows the active pattern number, mute status, pattern name, and chord:

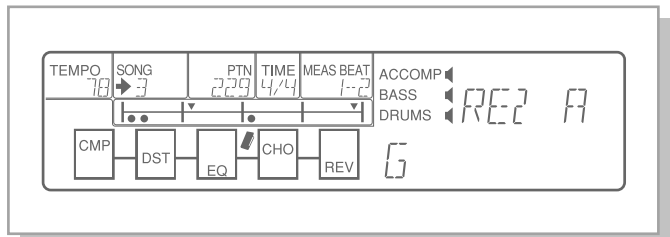

Note: VIEWING MULTIPLE RECORDED EVENTS—With the song stopped and the cursor arrow in the Backing mode display, and when the position indicator is moved to position where certain multiple events have been recorded, each event appears briefly in the LCD, one after the other. (See the section “Viewing Recorded Events,” page 90, for details.)

ASSIGNABLE Block and Pedal Switch Functions in Song Mode

Backing Control — Selecting and Playing a Song

Operation —

1. Use the ASSIGNABLE Block Type switch to select BACKING CONTROL. (The LED next to the function name lights.)

Note: Chord Recall cannot be selected here. Only Backing Control is available in the Song mode (in playback). When pressing [SONG/PATTERN] to select the Pattern or Song mode, Backing Control will automatically be selected.

2. The Pedal Switches function as shown below. Press the appropriate Pedal Switch for the desired function.

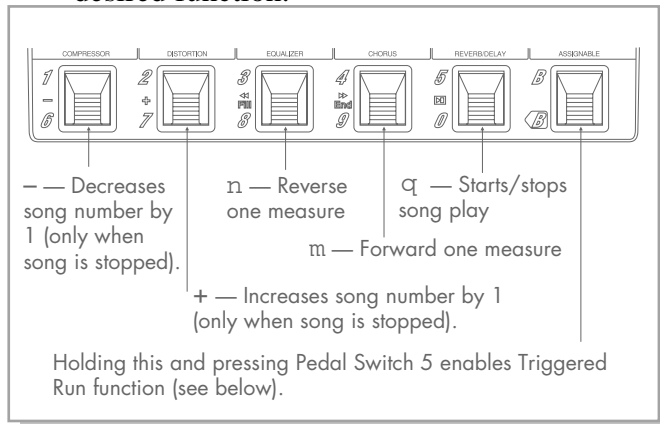

Triggered Run

Triggered Run lets you start the currently selected song by simply playing a note on the connected instrument.

Operation —

1. Make sure that BACKING CONTROL has been selected in the ASSIGNABLE Block.
2. Press and hold down the ASSIGNABLE Block Pedal Switch.
3. While holding down the ASSIGNABLE Block Pedal Switch, press Pedal Switch 5 (start/stop).

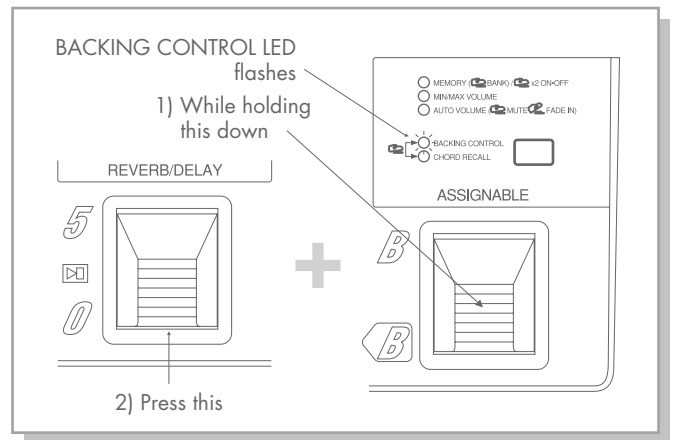

The instrument sound output will be cut off temporarily, and the song playback is in standby condition waiting for an input signal.

4. Play a note on the connected instrument. If the input level of the GW50 has been set appropriately and the note is not too low, the song will start.

This initial note is muted; however, once the song starts, the instrument sound is output again.

RECORDING AND EDITING SONGS

Virtually all of the functions of the Pattern mode — including selecting patterns, changing chords, muting and turning on backing tracks, etc. — can be programmed into a song for completely automatic playback. You can also have effect programs automatically change within a song, as well as the on/off (bypass) setting of individual effects. Moreover, using several techniques described in the Hints section (page 87), you can customize the accompaniment patterns and bass lines for creating highly sophisticated recordings.

Two different recording methods are available: Realtime and Step. (See page 37 for a more detailed discussion of the two methods.) Up to eight songs can be recorded, each song having a maximum length

of 299 measures, with a maximum of 4000 chord events available for all songs. (However, if individual songs have a large amount of recorded data, less than eight songs may be available.)

Keep in mind that once you do any recording or editing to a song, the changes that you make are automatically saved to that song number. The original song is altered or lost. For this reason, you should be careful when recording or editing an existing song. If you have song data you wish to keep, you should use the MIDI Bulk Transmission function (see page 102) to save it before recording or editing. If you've erased one of the original factory songs, you can restore it. (See "RESTORING FACTORY PRESET SONGS," page 95, for details.)

REALTIME RECORDING MODE (REALTIME RECORDING)

Realtime recording allows you to enter data as the song is playing. The types of data that can be recorded in realtime, as well as how and when they can be recorded are shown in this chart:

Data Type	Method of Entry	Available Recording Position
Pattern	By panel controls.	At the beginning of the current measure.*
Chords	By Pedal Switches only; also by panel controls during record standby.	At start of song, and any point after.
Effect program numbers	By Pedal Switches or panel controls.	At start of song, and any point after.
Effect on/off setting	By Pedal Switches only.	At start of song, and any point after.
Backing (Accompaniment, Bass, Drums) mute status	By panel controls.	At start of song, and any point after.

* When the current song has no recorded patterns, a single pattern may be selected during record standby, and it will be entered once recording has started. In Realtime recording, a pattern can be entered only one time, and pattern changes can be entered only in Step recording.

Note: ABOUT TEMPO CHANGES AND RECORDING—
Tempo changes themselves cannot be recorded. However, the tempo of the song can be changed manually, either during or before or after recording of a song, and the last tempo setting made is the one that is subsequently used for the song. For example, if you've originally recorded a song at a tempo of 120 and you later change this to 135 during playback, the next time you select the song, it will play back at the new tempo of 135, not 120.

This section on Realtime recording is divided into three basic parts: 1) overall operation instructions, 2) individual instructions on recording different types of data, and 3) helpful hints. You may want to skim through all three parts first, then follow the instructions in the first two parts as you record a song. The section of hints at the end provides some practical tips and helpful additional information for recording.

1) Overall Operation Instructions

1. First, make sure that the Song mode has been selected (the SONG LED should be lit).

Then, using [6 CURSOR] move the cursor arrow to SONG in the display and select an empty song number with the [-]/[+] buttons for recording. (Song number 8 has been deliberately left blank for this purpose.)

If there are no empty songs, you'll have to use the Measure Delete function to erase a song before continuing (see pages 94-95). You can check for empty songs by trying to play back each song; "SONG EMPTY" briefly appears in the display if the song has no data, and the song will not play back, and pressing [START/STOP] has no effect.



CHECKING FOR DATA IN A SONG—Another way to check whether a song is empty or not is to make sure the position indicator is at the beginning of the song, then simultaneously press [/] and [m] to go to the last recorded data in the song. If the position indicator stays at the same place, the song is empty.

2. Make sure that the position indicator in the display is at the start of the song. (Simultaneously press the [n] and [v] buttons if necessary.)

Note: Generally, you should start recording at the beginning of a song, since the GW50 needs to recognize both a chord and a pattern to start playback. If the starting measures of a song are empty, but there is pattern data in later measures, the GW50 automatically provides a default chord (C) and the METRO pattern (No. 246) for the empty starting measures. (Since the METRO pattern has no bass or accompaniment parts, however, the chord sound cannot be heard while METRO is playing.) If the song has no pattern data, but other data exists, the GW50 automatically provides a METRO pattern for the entire song.

3. To enable song recording, simultaneously hold down [SHIFT] and press [SONG REC]. Recording is now in standby. (The SONG LED flashes and the cursor arrow in the display automatically moves to the PTN or TEMPO box.)

Note: You can cancel recording here by pressing [SONG REC] again (without [SHIFT]).

4. Using [6 CURSOR], move the cursor arrow to PTN in the display and select the pattern number with which you wish to start the recording with the [-]/[+] buttons.

Note: Once a pattern has been set for a song, it cannot be changed during Realtime recording (the cursor arrow cannot be moved to the PTN box in the display). However, you can change and enter patterns by using Step recording operations if necessary. (See page 88.)

5. You may also want to select the chord for the start of the song. Do this from the Chord section (see page 74), or by using the CHORD RECALL function of the Pedal Switches (see page 86).
6. Press [START/STOP] to start recording. (The pattern and chord that you selected in steps #4 and #5 above are automatically entered to the first 16th note in the song, and a dot appears at the position to indicate recorded events.)

The Position Controls ([n], [v], [/], [m]) can be used to "pause" the song during Realtime recording (for recording standby), and select a different measure or position in a song. To resume recording, simply press [START/STOP]. (For more information, refer to Hint #7 on page 88.)

Note: When a song is running, the LCD display in Realtime recording is the same as that for song playback (see page 79).

Note: If for some reason the position indicator is not at the first 16th note in the song but instead is at some point in the middle of the measure, the chord will be properly entered at the indicated position, but the pattern will be entered at the beginning of the measure (since patterns cannot begin in the middle of a measure).

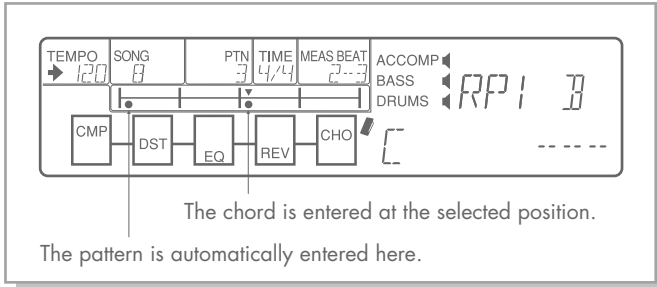

Note: USE OF STARTING EVENTS AT BEGINNING OF SONG—If you intend to record Backing mute status, effect program numbers, and effect on/off events at some point in a song, you should enter starting events for these types of data as well. If no such events are recorded at the beginning of the song, the GW50 simply plays back the current settings. Thus, the start of the song (up until the properly entered data) may not sound as you expect.

To record Backing mute status, effect program numbers, and effect on/off events at the start of a song:

Operation —

1. Simultaneously press [SHIFT] and [SONG REC] to enable recording.
2. Make the desired settings. (Even if the current settings are the ones you wish to use, you must actually use the panel here to select them; the GW50 will not record the current settings of these types of events unless they are properly set from the panel.)
3. Press [START/STOP] to start recording. The data is automatically recorded to the start of the song.

7. Enter additional data as the song plays, as described in the sections below. (Event indicator dots in the display appear at the position each time data is entered.)

8. Stop recording by pressing [START/STOP].

Note: Doing this exits the Realtime recording mode and automatically returns to the Song mode.

2) Individual Instructions on Recording Different Types of Data

The sections below provide detailed instructions for recording specific events.

■ To record chord changes in realtime:

1. Before recording the song, go to the Pattern mode and assign the chords that you wish to record to the four available Pedal Switches. (See page 78.)
2. Return to Realtime recording, and make sure that the CHORD RECALL function is selected in the ASSIGNABLE Block, then start recording (see “REALTIME RECORDING” section steps #3 and #6 above).
3. Then, while recording the song, press the appropriate Pedal Switches at the points in the song that you want the chords to change.



Since only four different chords can be assigned to the Pedal Switches and you may want to record more in the song, simply repeat the operation above — this time, after assigning four new chords to the Pedal Switches — and start recording from where you left off the last time.



ASSIGNABLE Block and Pedal Switch Functions in Song Realtime Recording

Chord Recall

Backing Control cannot be selected in Realtime Recording mode. Only Chord Recall is available here. When using [SHIFT] + [SONG REC] to select the Realtime Recording mode, Chord Recall will automatically be selected.

The pre-assigned chords in the Pattern mode can be used here.

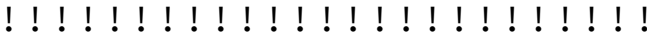
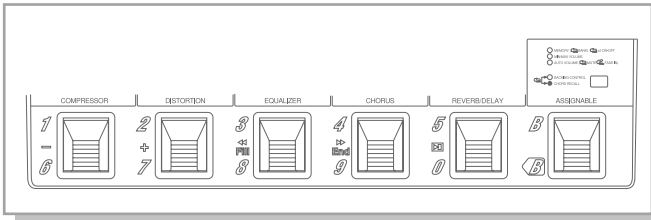

■ To record muting data (turning on/off the Accompaniment, Bass and/or Drums parts): While the song is recording, simply hold down [SHIFT] and press the appropriate button ([ACCOMP], [BASS] or [DRUMS]).

■ To record effect program changes in realtime:

1. Before recording the song, select the Memory mode (press [MEMORY]).
2. Make sure MEMORY is selected in the ASSIGNABLE block. (The LED will be lit continuously, not flashing.)
3. Select the bank number in which the desired effect programs are located.

Note: This step is optional, since you can also select the bank number with the Pedal Switches in step #5.

4. Make sure that Realtime recording is enabled and that MEMORY is selected in the ASSIGNABLE block (the LED is lit), then start recording (see “REALTIME RECORDING” section steps #3 and #6 above).
5. Then, while recording the song, press the appropriate Pedal Switches at the points in the song that you want the effect programs to change.

Note: TIMING OF EFFECT PROGRAM EVENTS—Since effect program events take slightly longer than other events to register, you should record them a little before the position you want them to actually take effect. A good rule of thumb is to record an effect program change about four 16th notes earlier, for a tempo of 120.

■ To record effect bypass changes in realtime:

1. Before doing this, you should record an appropriate effect program, for which you will turn individual or group of effects on and off.
2. Make sure that: 1) Realtime recording is enabled (see “REALTIME RECORDING” section, steps #3 and #6 above), 2) Memory mode is selected, and 3) MEMORY ON/OFF is selected in the ASSIGNABLE Block (the LED flashes). Finally, start recording.
3. Then, while recording the song, press the appropriate Pedal Switches at the points in the song that you want to bypass or turn on effect blocks.

3) Hints on Realtime Recording



ENSURING PROPER SONG ENDING—Keep in mind that the end of the song is not the point at which you pressed [START/STOP] to end recording, but is determined by the last event entered in the song.

In the example shown below, the last event recorded to a song is a chord change, and [START/STOP] was pressed to end recording several measures after that.

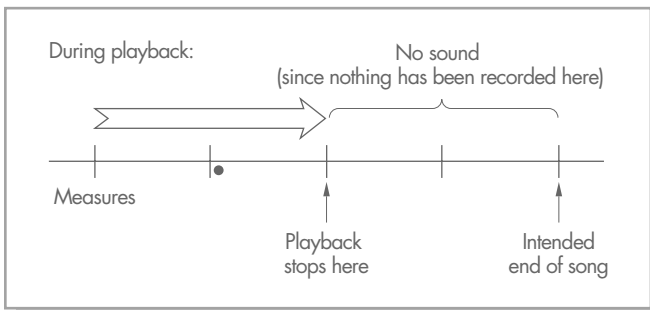
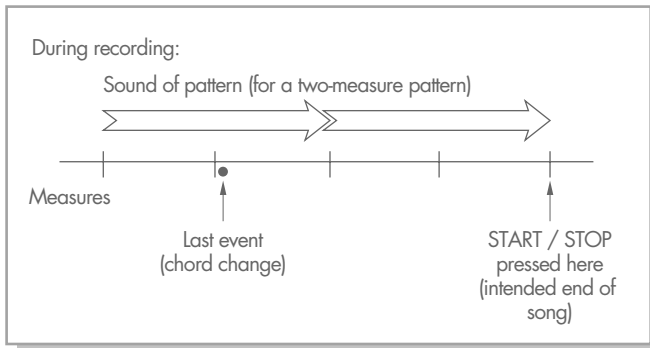

To actually end the song at the point you originally intended, you should enter some event at an appropriate point. Typical events for this purpose would be:

- 1 Chord (The same chord as the last one entered is fine.)
- 2 Accompaniment, Bass and Drums muting (All turned off at the same time; preferably done by Step recording.)
- 3 Ending pattern (Done by Step recording only.)

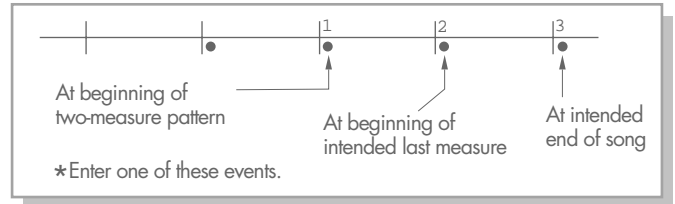

RECOMMENDED RECORDING ORDER—Even though there are no immutable rules to follow when recording a song, it's generally best to start by recording chord changes over a single basic rhythm pattern, then adding additional events as needed.



ENSURING PROPER TIMING IN REALTIME RECORDING—In Realtime recording, timing is important. You can make it easier to enter events in time by recording the song at a slow tempo. This gives you a better chance of “hitting” each event precisely. However, if you make a mistake in the timing while recording an event, you can always use Step recording and song editing techniques (see page 88) to erase the mistake and then enter it in the proper place.



RECORDING IN SECTIONS—Keep in mind that you can also start recording from the middle of a song. This would come in handy when you have a fairly complex song with a lot of chord changes and mute status changes that would be difficult, or impossible, to record all at once.

Think of the song in sections, and stop the recording (or pause it using the Position Controls) at the end of each section. Then, to record the next section, use the position controls to move to the desired measure (or slightly before), and begin or resume recording as usual. Of course, if you want to, you can start recording from the beginning and “jump in” when you're ready to record the next part.



OVERDUB RECORDING—You can use the same technique as described in Hint #2 above to “overdub” events, or record different events over the measures in two or more passes. For example, you can record chord changes in the first pass and effect program changes in the second.



A Repeat function (A-B Repeat) lets you repeatedly and continuously record over a specified section of the song. (See page 93 for details.)



USING POSITION CONTROLS IN RECORDING—The Position Controls ([n], [v], [/], and [m]) can be used to pause the song during Realtime recording (for recording standby), and select a different measure or position in the song. You can also set events such as effect program number and effect on/off settings at the paused position, and these will be automatically entered once you resume recording.

To do this:

1. While the song is recording in realtime, press any of the Position Controls ([n], [v], [/], and [m]). Song recording will then pause.
2. Use the Position Controls to select a different position in the song. (The jump-to-beginning (b) and jump-to-end (¶) controls can also be used in this condition.)

The effective chords, patterns and mute on/off status events at the current position are indicated in the LCD display, when the Backing mode display is selected (the cursor arrow appears at the PTN or TEMPO box).

3. If you want, you can set additional events here as recording is paused. These will automatically be recorded to the current position when you press [START/STOP] to resume recording in realtime. Then, as Realtime recording continues, you can “overdub” additional events as you wish.



MUTE, BASS NOTE, AND RETRIGGER—The various automatic accompaniment and recording features of the GW50 make it possible to easily create polished, complex compositions. Here are three important tools and some ideas on how to use them:

- Mute (page 86) — The Mute function can be used to create sophisticated arrangements and textures, allowing you to selectively bring instruments in and out, adding variety to the song.

- Changing the bass note function (page 75) — This lets you make your own bass lines; keep in mind that you can enter a different bass note for each 16th note in a measure.

- Retrigger — The Retrigger function lets you record rhythmic “hits” in which some of the Backing parts sound altogether, to create accents in a song. Special Retrigger patterns (nos. 241 – 244) are provided for this purpose, letting you enter the retrigger “hits” by entering a chord event at the desired 16th note position. However, the Retrigger function can be used with any of the other patterns by entering a chord event while a note of the pattern data is playing (in other words, not during a rest).

To get a better idea of how the above tools can be effectively used, refer to the section “USE OF ADVANCED RECORDING TECHNIQUES—FACTORY SET SONG 1” on page 153.



MUTING SUSTAINED SOUNDS—Since mute events only affect notes on or after the event, it is possible that certain backing sounds may continue even after the mute. For example, if a whole note bass note starting at the top of a measure is muted part of the way through the measure, the note will continue to sound to the end of the measure. You can mute the note part of the way through the measure by entering both a mute event and a Retrigger or chord event at the desired position. In effect, this cuts off the current note, replacing it with the new Retrigger or chord event; however, this new event is not heard, since a muting event occurs at the same position. (Also see page 154.)

STEP RECORDING MODE (STEP RECORDING)

Step recording allows you to individually and precisely enter data “step-by-step” to each 16th note in a measure, without having to worry about the timing problems inherent in Realtime recording.

The following chart indicates the types of data that can be recorded in Step recording as well as how and when they can be recorded.

Data Type	Method of Entry	Available Recording Position
Patterns (including Fill In, Ending)	By panel controls only.	At the beginning of any measure.
Chords	By panel controls only.	Anywhere in song.
Backing (Accompaniment, Bass, Drums) mute status	By panel controls.	Anywhere in song.

Note: ABOUT TEMPO CHANGES AND RECORDING—Tempo changes themselves cannot be recorded. However, the tempo of the song can be changed manually, either before, during or after recording of a song, and the last tempo setting made is the one that is subsequently used for the song.

Operation —

1. Make sure that the Song mode has been selected (the SONG LED should be lit), then use [6 CURSOR] to move the cursor arrow to SONG in the display and select an empty song number for recording. (You can also use an existing song that has data, and add new data to it.)

Note: In Step recording, you do not need to use the [SONG REC] button. As long as you are in the Song mode and the song is stopped, Step recording can be performed at any time.

Note: If you have to erase a song to make an empty song, refer to operation step #1 in “REALTIME RECORDING”, page 83; also see page 95 for details on erasing a song.

2. Make sure that you are at the beginning of the song, then use [6 CURSOR] to move the cursor arrow to PTN in the display and select the pattern number with which you wish to start the recording.
3. Also, set all the other data that you wish to record at the start of the song: the starting chord (see page 84) and the initial Backing mute status (see note below for instructions).

(For more information on recording data at the beginning of a song, refer to step #2 on page 84 in “REALTIME RECORDING.”)

Note: SETTING BACKING MUTE STATUS—To set the Backing mute status, simultaneously hold down [SHIFT] and press the button corresponding to the part you wish to mute or turn on ([ACCOMP], [BASS] or [DRUMS]). (The speaker symbol in the display next to each part appears when the part has been turned on.)

4. To record all the data you’ve set in steps #2 and #3 above, press [ENTER]. (All events are automatically recorded to the position with one press of [ENTER]; a dot appears at the position to indicate recorded events.)

Note: In Step recording, pattern numbers can only be recorded to the first 16th note of a measure. A pattern cannot begin playing in the middle of a measure. (If you attempt to do this, an “ONLY MEAS TOP” message appears in the display.)

5. After step #4, the position indicator in the Measure/Event section of the display automatically moves ahead (by one quarter note) to the next beat in the measure. You can record the next event or events there, or use the Position Controls to move ahead or back to any 16th note position in any measure.



RECORDING EFFECT CHANGES—Even though effect program changes and bypass (effect on/off) events cannot be actually entered in Step recording, you can pause recording in Realtime recording and enter them individually (see hint #7 on page 88).

Note: MULTIPLE EVENTS—Remember that several events of different types can occupy the same position in a song. However, since two events of the same type (for example, two different chords) cannot occupy the same position, the most recently recorded event takes precedence and the previous one is erased.



USING BOTH REALTIME AND STEP RECORDING—Realtime recording and Step recording can be effectively used in tandem with each other. Though the possible uses are too numerous to explain here, one common application is given below:

Operation —

1. Enter a single pattern at the beginning of the song and record the basic chord changes of a song in Realtime recording.
2. Use Step recording to add pattern changes in the song, putting in Fill In patterns and variations, as well as changing to another basic pattern.
3. Switch back and forth between the two methods as necessary, generally

using Realtime recording to record chord and Backing mute status changes “on the fly,” and using Step recording to put in pattern changes and when you wish to enter events to specific positions in the song.

4. Also, take advantage of the various song editing operations (described in “SONG EDITING” and “SONG JOB MODE” below) to correct mistakes, erase or copy sections of the song, and perform other functions.



Also refer back to Hints #1, #3, #8 and #9 on pages 87 and 88, since these are also useful in Step recording.

SONG EDIT MODE (SONG EDITING)

Viewing Recorded Events

You can easily tell whether an event has been recorded in a measure or not and what position it has been recorded to, since it appears as a dot (or “Event indicator”) in the Measure/Event section of the display (when playback of a song is stopped in Song mode and when the cursor arrow is in the Backing mode display). By moving the position indicator to one of these dots (by using the Position Controls), you can also check what event or events have been recorded at the position. The various types of events are indicated on the GW50 as follows:

Patterns — Pattern numbers are indicated in the PTN (Pattern) box and the pattern name appears in the top right of the LCD.

Effect program numbers and effect on/off settings — These are shown in alternation with or instead of the pattern name and chord in the right part of the LCD. (See note “VIEWING MULTIPLE EVENTS,” page 91.)

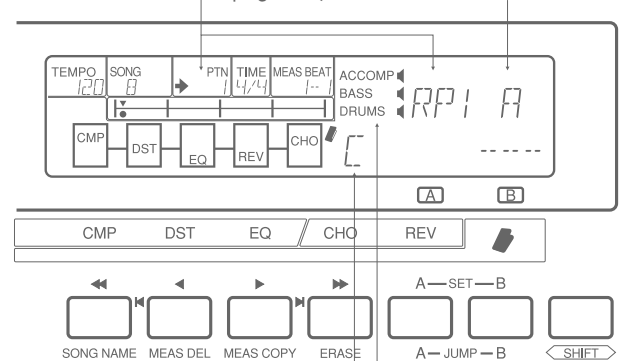

Chords — Chords are indicated at the bottom right of the LCD.

Muting of backing parts — The speaker symbol to the right of BASS, ACCOMP, and DRUMS in the display indicates that the corresponding part will be turned on from this position. No speaker symbol indicates that the part will be muted.

Note: DISPLAY DIFFERENCES IN BACKING MODE AND EFFECT MODE—The recorded chords, patterns and mute on/off status events at the current position are indicated in the LCD display, when the Backing mode display is selected (the cursor arrow appears in the TEMPO, SONG, and PTN boxes in the display). When the Effect mode display is selected (the cursor arrow disappears), “MANUAL” or the current effect program name is shown in the LCD instead of the pattern name and current chord.

Note: VIEWING MULTIPLE EVENTS—When multiple events have been recorded to the same position in a song, each event appears briefly in the LCD, one after the other. For example:

When four events (pattern, chord, effect program number and effect on/off) have been entered to the same position, the three following indications will appear in succession in the LCD.

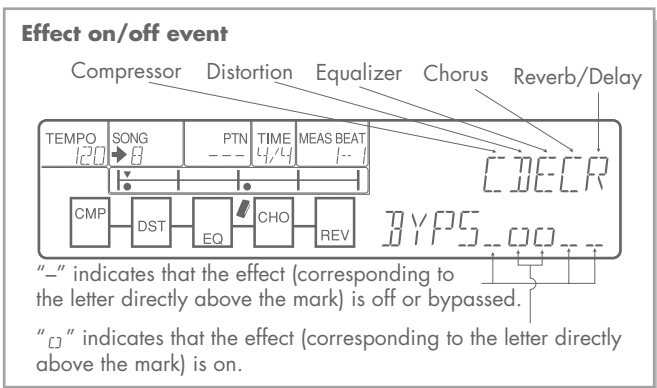
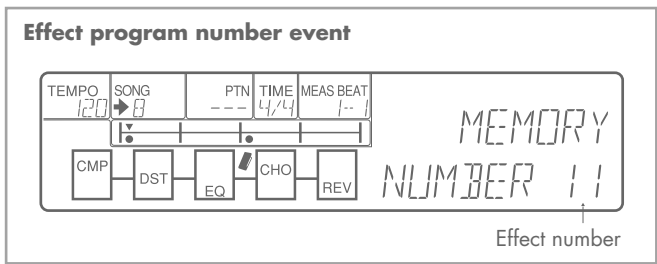
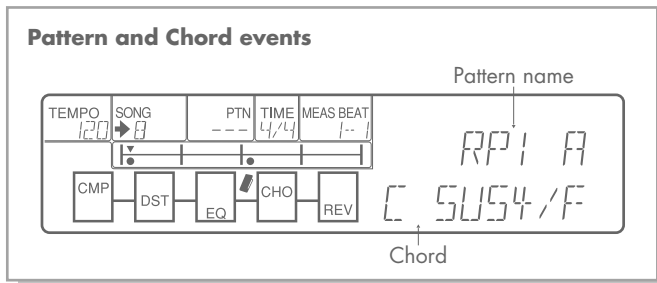

Note: ABOUT EFFECT EVENTS—Effect program number and effect on/off events are indicated in the LCD for the positions to which they were recorded. However, the effect program number shown in the BANK/MEMORY indicator LED and the effect on/off status shown by the LEDs in the effect blocks indicate the current state of the Effect section of the GW50.

Let’s say, for example, that effect program number 12 has been recorded at the start of a song, and a change to program number 44 has been recorded to the thirteenth 16th note of the fourth measure (as shown below). When you move the position indicator to the thirteenth 16th note of the fourth measure, the LCD shows “44,” but the BANK/MEMORY LED

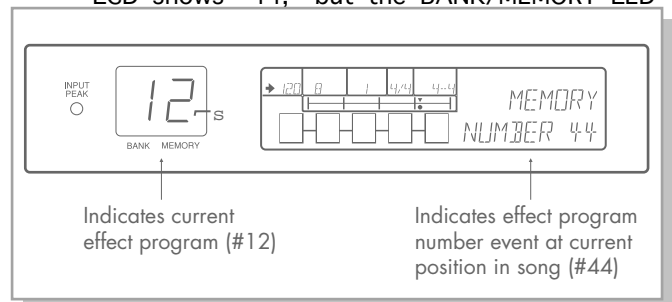

The two indications are different because the Backing section is stopped and the event (#44) has not been played yet.

If you move the position indicator one 16th note step forward, the BANK/MEMORY LED will change to “44” accordingly.

Also, consider that the current effect program number may be changed via the Pedal Switches or panel controls without the position indicator being moved.

Therefore, there will always be a discrepancy between the effect program number event data displayed for the Backing section and the actual effect program number currently active in the Effect section. (All of the above applies to effect on/off events, as well.)

Simply put, the BANK/MEMORY indicator and effect block LEDs indicate the current condition of the Effect section; the LCD indicates the events that have been recorded to the song in the Backing section. These two are different.

Note: When at a position where no event exists and you press any of the four main position controls ([n], [v], [/], or [m]), the currently active pattern number, mute status, pattern name, and chord appear in the display. (Also refer to the note in “POSITION CONTROLS,” page 81.)

Make sure that the Song mode is selected before attempting the following operations.

Editing (Changing) Recorded Events

Editing a recorded event is done in the same way as Step recording. First, move the position indicator to the event you wish to change, select the new value or setting, then press [ENTER]. (The data that can be entered is the same as that for Step recording; see page 89.)

Erasing Recorded Events

To erase a single recorded event (or all events at a specific position), move the position indicator to the position of the event(s), then hold down [SHIFT] and press [ERASE].

Set-A and Set-B Operations

By using the Set-A and Set-B operations, you can specify a series of consecutive measures, and have them repeat, copy them to another location in a song, or delete them. You can also use the A and B marks to instantly “jump” to a specified measure.

Marking Measure A and Measure B

Operation —

1. Use the Position Controls [<<] [<] [>] [>>] to select the measure to be marked as “A.”
2. Press [SET-A].

3. Use the Position Controls to select the measure to be marked as “B.”

4. Press [SET-B].

You can check the current measure A and B settings by holding down [SHIFT]. The settings also appear briefly when you set them in steps #2 and #4 above.

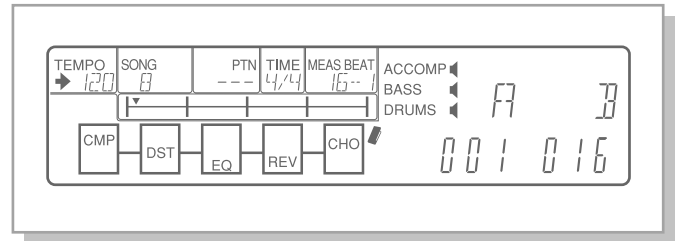

Note: ABOUT THE “A” AND “B” MARKS—When using the Repeat or Copy functions, the “A” mark corresponds to the beginning of measure A and the “B” mark corresponds to the end of measure B. When the Jump function is used, both the “A” and “B” marks correspond to the beginning of those respective measures. A specific beat or 16th note (other than the first) cannot be marked; the marks are for measures only. Also, the “B” mark cannot be set to a measure earlier than “A.”

Jumping to Measure A or Measure B

To jump to a marked measure, simultaneously hold down [SHIFT] and press [JUMP-A] to go to measure A, or [JUMP-B] to go to measure B.

Loop (Repeat) Playback (A to B)

This function allows you to repeat indefinitely the measures between A and B.

Operation —

1. Mark the A and B points of the measures you wish to repeat.
2. Simultaneously hold down [SHIFT] and press [A-B REPEAT ↻]. The “repeat” indication appears in the SONG box.

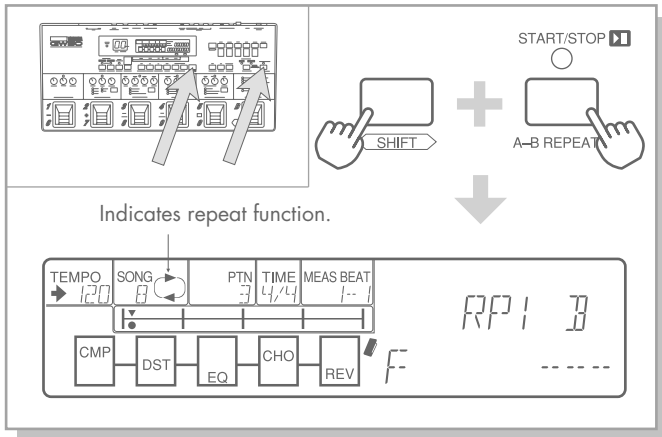

3. Use the Position Controls to move to the starting position in the song, at or before measure B.
4. Press [START/STOP] to begin playback. Playback will start from the point selected, continue to measure B, go back to measure A, and repeat between A and B indefinitely.

Note: For the A-B Repeat function to operate properly, you should start playback from a point AT or BEFORE measure B.

If you start from a point AFTER the B measure, the song will playback until the end of the song and then simply stop, without going to either the A or B measure.

This happens because the A-B Repeat function “looks for” the B measure, and if it is not “found” (in other words, if there is no B measure after the playback starting point), there will be no repeat.

5. Press [START/STOP] to stop playback.
6. To turn off the repeat function, simultaneously hold down [SHIFT] and press [A-B REPEAT] again.

Loop (Repeat) Recording (A to B)

This function allows you to record events in realtime, while a specified range of measures (A to B) loops or repeats indefinitely.

Operation —

1. Mark the A and B points of the measures you wish to repeat.
2. Simultaneously hold down [SHIFT] and press [A-B REPEAT]. The “repeat” indication appears in the SONG box.

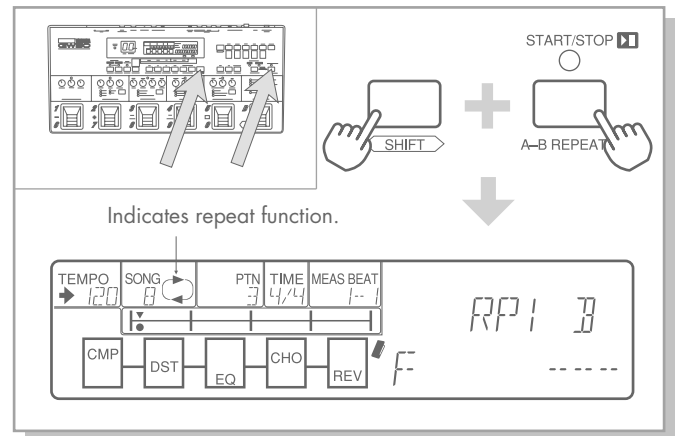

3. Simultaneously press [SHIFT] and [SONG REC] to enable recording.

Note: In Repeat recording, if the current position is somewhere outside the A-B region (before or after), the position indicator automatically moves to the beginning of measure A for the starting position, when step #3 is executed.

4. Use the Position Controls to move the starting point within the A-B region, if you wish.

Note: POSITION CONTROLS IN REPEAT RECORDING—

The Position Controls are only effective within the A-B range in Repeat recording. Moreover, the jump-to-beginning (b) and jump-to-end () controls function respectively the same as JUMP-A and JUMP-B. In other words, pressing [n] + [v] moves the position to the beginning of measure A, not the beginning of the song, and pressing [/] + [m] moves the position to the beginning of measure B, not the last event of the song.

5. Press [START/STOP] to begin recording. Recording will start from the point selected, continue to measure B, go back to measure A, and repeat between A and B indefinitely.

6. Press [START/STOP] to stop recording.
7. To turn off the repeat function, simultaneously hold down [SHIFT] and press [A-B REPEAT] again.

SONG JOB MODE

Copying Measures Between A and B

This function allows you to copy the data between the two marked measures to another location in the song. This is a convenient composing tool, since it lets you easily copy parts of the song that are similar (such as the verse sections), without having to program each measure.

Operation —

1. Mark the A and B points of the measures you wish to copy.
2. Use the position controls to select the destination measure.
3. Simultaneously hold down [SHIFT] and press [MEAS COPY]. (You can still use the position controls to select the destination measure here, if you wish.)
4. Press [SET-B] (below “GO”) to copy the measures, or press [SET-A] (below “EXIT”) to abort the operation.

Note: In the Copy and Delete operations, the measure numbers for the A and B points do not change after the operations, but the actual contents may be altered. For this reason, you should be careful when copying the same section to different parts of the song, for example; the desired section may have been moved from its original location because of a Copy or Delete operation.

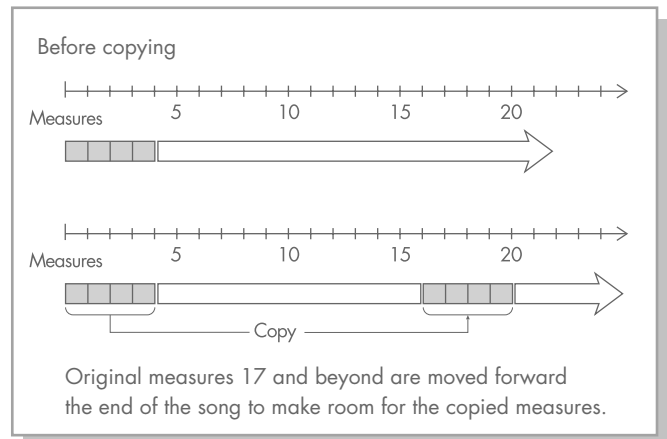

Notice that this operation inserts the measures at the destination and shifts all existing measures there forward toward the end of the song to make room for the copied measures.

Deleting Measures Between A and B

This function allows you to delete a specified range of measures from a song.

Operation —

1. Mark the A and B points of the measures you wish to delete.
2. Simultaneously hold down [SHIFT] and press [MEAS DEL].
3. Press [SET-B] (below “GO”) to delete the selected measures, or press [SET-A] (below “EXIT”) to abort the operation.

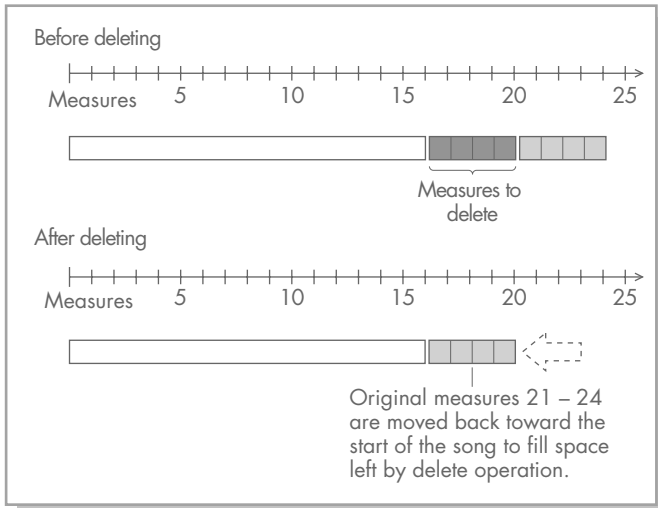

Notice that this operation shifts all existing measures after measure B back toward the start of the song.



DELETING ALL DATA OF A SINGLE SONG

The following operation can be used to delete all the data of a song. Simply mark measure A to the starting measure of the song and measure B to the ending measure (measure with the last event) (using [n] + [v] and/or [/] + [m] if necessary), then delete the range of measures.

Naming Songs

Operation —

1. Select the song to be named, or use the song currently being recorded.

2. Simultaneously hold down [SHIFT] and press [SONG NAME].

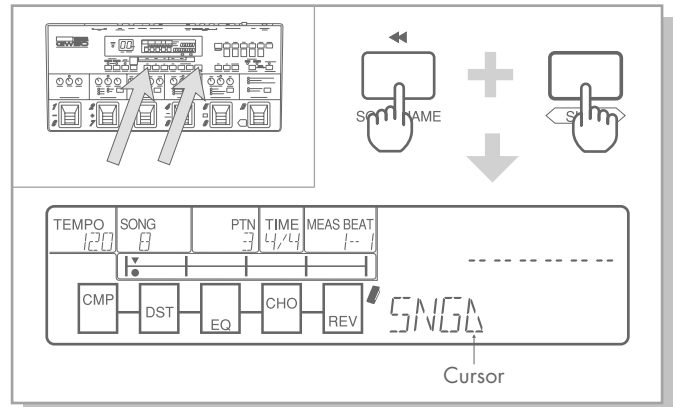

3. Use the [-]/[+] buttons to select the desired character at the cursor position. Use [6 CURSOR] to move the cursor (<) in the display. The following characters are available for naming:



4. Press any of the mode buttons to exit the operation. The name is automatically saved to the song and briefly appears whenever the song is selected.

RESTORING FACTORY PRESET SONGS

If you've erased one of the factory songs by replacing it with one of your own creation, this function lets you restore the original song.

Operation —

1. Turn off the power of the GW50.

2. Simultaneously hold down [SONG] and turn the power back on. (The SONG LED lights and "LD SONG" appears in the LCD.)

3. Select the number of the song you wish to restore with the [-]/[+] buttons.

4. Press [SET-B] (below “GO”) to restore the song, or press [SET-A] (below “EXIT”) to abort the operation. (You can also abort the operation by using any of the mode buttons: [MANUAL], [MEMORY], or [SONG/PATTERN].)



You can continue loading successive factory songs by repeating steps #3 and #4 above as necessary.

Note: Keep in mind that this automatically and irretrievably erases the song you created at the selected number. To avoid losing the song entirely, save it and others you have created by using the MIDI Bulk Transmission function. (See page 102.)

The logo for the GW50 device, featuring the text "GW50" in a stylized, outlined font. To the right of the text, there are several horizontal lines that transition into a series of parallel lines that fan out to the right, creating a sense of motion or connectivity.

GW50

REFERENCE

OTHER FUNCTIONS (TUNER/MIDI)

TUNER MODE	99
MIDI	101
MIDI BULK TRANSMISSION MODE	102
CHANGING EFFECT PROGRAMS ON THE GW50 FROM A CONNECTED DEVICE	103
CHANGING PROGRAMS ON A CONNECTED DEVICE FROM THE GW50	104
TURNING INDIVIDUAL EFFECTS ON AND OFF FROM A CONNECTED DEVICE	104
SYNCHRONIZING ANOTHER DEVICE WITH THE GW50	105
USING THE BACKING PATTERNS TO PLAY OTHER SOUND MODULES	106



TUNER MODE

The built-in Tuner lets you tune your instrument simply and quickly without having to remove it from the INPUT jack.

Operation —

1. Simultaneously hold down [SHIFT] and press [TUNER] (or simultaneously press and hold down Pedal Switches 1 and 2 until the Tuner mode display “PITCH” appears in the LCD).



The output sound is automatically cut off when the Tuner is turned on, so that you can tune your guitar silently on stage.

2. Play only one string on the guitar.

The number of the string (when one of the open strings — E, A, D, G, B, or E — is played) and the note name appears in the BANK/MEMORY indicator. The tuning is indicated both in the Measure/Event section of the LCD and by the red LEDs of the effect blocks, as shown below.

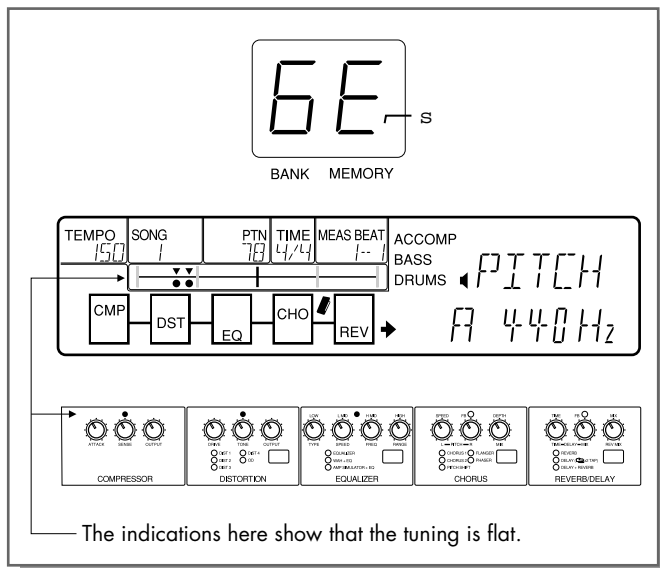

Note: The flashing dot in the BANK/MEMORY indicator represents “s” or “sharp”.

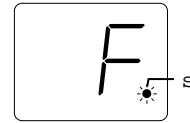

3. Tune the string so that the indicators are in the center as much as possible.

The tuning is made for a standard pitch of A = 440Hz (as shown in the display). However, this can be adjusted up to 445 Hz if you wish by using the [-]/[+] buttons. (The pitch of the backing tracks is also raised by this operation.) The last setting mode is retained even after the power is turned off.

4. Continue in the same way with the other strings.
5. Return to normal operation by pressing any of the mode buttons (or any of the Pedal Switches).

The illustration below shows the various tuning indications both in the Measure/Event section of the LCD and in the effect block LEDs, along with the amount in cents away from normal pitch.

LCD Indications

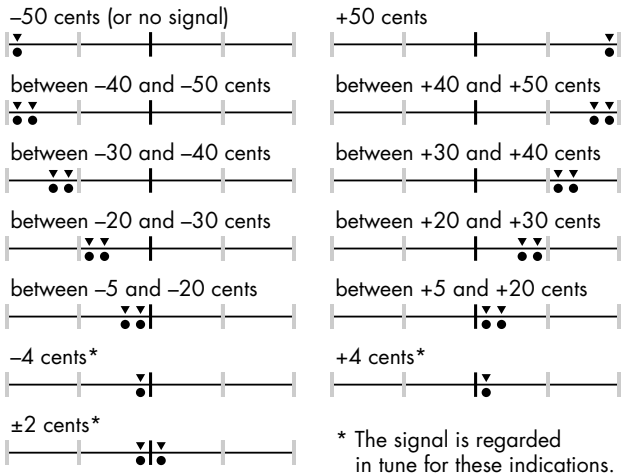

* The signal is regarded in tune for these indications.

Effect Block LED Indications

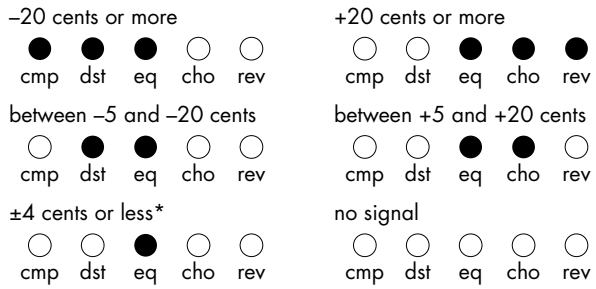

MIDI

MIDI (Musical Instrument Digital Interface) is a system built into many electronic and digital musical instruments. It allows many different devices — not only instruments, but computers, effect devices, and so on — to “communicate” with each other. Some typical applications include playing one instrument from the controls of another, recording performances as MIDI data to a sequencer for further editing and control, and instantly changing the programs and settings on many connected devices from just one device.

The MIDI functions and applications of the GW50 include:

- * MIDI Bulk Transmission — for storing effect program, song data, and other settings to another MIDI data storage device.
- * Program change reception — for changing effect programs on the GW50 from another MIDI device.
- * Program change transmission — for changing programs on another MIDI device from the GW50.
- * Control change reception — for turning individual effects on and off from another MIDI device (via Control Change messages).
- * Synchronizing another MIDI device (such as a rhythm machine or sequencer) to the Backing section of the GW50.
- * Using the rhythm, accompaniment and bass patterns to play sounds on other MIDI sound modules.

The rest of this section provides instructions on how to use these functions. For all MIDI applications given below, connect the devices as shown in the illustration:

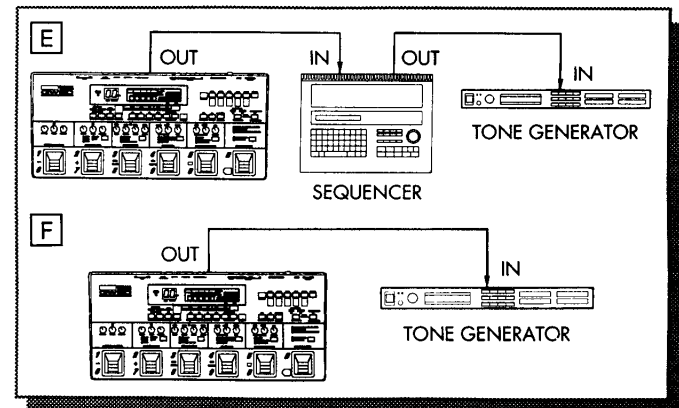
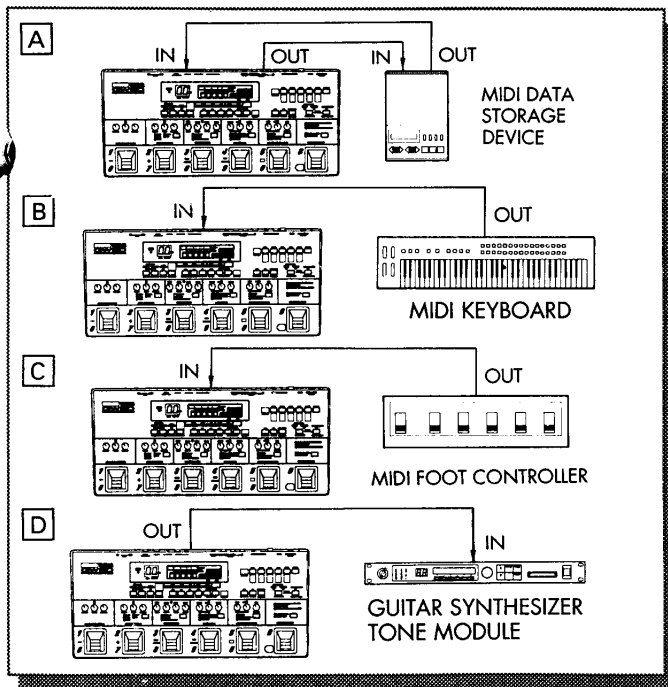

Note: This manual cannot cover every application or connection possibility. For more information on how to use the GW50 in a MIDI system, refer to the owner's manuals of the other MIDI devices you are using, or read any of the many books and magazine articles on MIDI applications and setups.

MIDI BULK TRANSMISSION MODE

Although the GW50 has space in memory for 50 effect programs and 8 songs, you may want to free up that memory for additional programs and songs. Also, you may want to save the existing programs and songs to another device for backup purposes. The MIDI Bulk Transmission function lets you do this. For quick, safe and economic storage of GW50 data, use the Yamaha MDF2 MIDI Data Filer.

Note:USE OF OTHER MIDI DATA STORAGE DEVICES—

Though the operation steps for transmitting and receiving data below assume you are using the MDF2 MIDI Data Filer, they also apply to any MIDI data storage device. (Refer to the owner's manual of the device you are using for more information.)

Storing GW50 Data to the MDF2 (Transmitting)

Operation —

1. Connect the Yamaha MDF2 MIDI Data Filer to the GW50 as shown in MIDI connection example A on page 101.
2. Prepare the MDF2 for receiving MIDI data. (Refer to the owner's manual of the MDF2.)
3. Simultaneously hold down [SHIFT] and press [MIDI BULK].

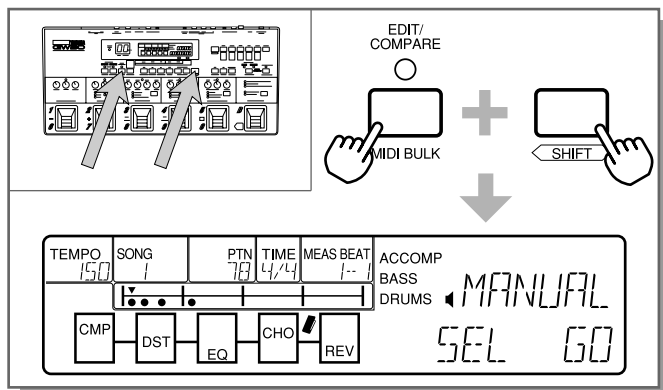

4. Use [SET-A] (below “SEL,” Select) to determine the type of data to be transmitted. The following settings are available:

MANUAL — The current effect settings in the Manual mode [with the exception of the parameter knob (main parameter) settings].

1MEM — One effect program (selected prior to step #3); this includes all effect settings of a program.

ALLMEM — All 50 effect programs currently in memory.

1SONG — One song (selected prior to step #3).

ALLSNG — All 8 songs currently in memory.

SETUP — Miscellaneous data of the GW50 (includes: currently selected modes, bank/program numbers, song/pattern numbers, chord recall assignments, tuner pitch, etc.).

ALL — All the above settings.

For more information on the specific data that is transmitted for each of these settings, refer to the “MIDI SPECIFICATIONS” section on page 148.

Note:ABOUT “1 MEM” AND “1 SONG”—If you use “1 MEM” or “1 SONG” to transmit a single program or song, you must select that program or song before step #3 above. If you go to step #4 without selecting it, return to the appropriate mode (Memory or Song) by pressing [MEMORY] or [SONG/PATTERN], select the desired number with the [-]/[+] buttons, then return to step #3.

5. To send the data to the MDF2, press [SET-B] (below “GO”). When the operation is completed, the message “COMPLETED” will appear in the display. The MIDI Bulk Transmission mode remains active here, so you can continue to send other types of data as needed (with the exception of 1MEM and 1SONG; see above note). To exit the MIDI Bulk Transmission mode or abandon the operation without sending data, press any of the mode buttons: [MANUAL], [MEMORY], or [SONG/PATTERN].

Restoring GW50 Data from the MDF2 (Receiving)

Operation —

1. Connect the Yamaha MDF2 MIDI Data Filer as shown in MIDI connection example A on page 101, and prepare it for sending MIDI data. (Refer to the owner's manual of the MDF2.)
2. Make sure that the right type of data is selected on the MDF2, then execute the MIDI Bulk Dump function from the MDF2. When transmitting one effect program ("1MEM") or one song ("1SONG"), be sure to select the destination program number or song number to which you intend to transfer the data, before attempting the operation.

Bulk data can be received only in the main modes, and cannot be received while a song is playing.

Note:Single song data ("1SONG") can be received only if the destination song number on the GW50 is empty. If song data exists at the number, the message "SONG EXISTS" appears. Select an empty song or delete the current song before continuing. Also, keep in mind that types of data other than "1SONG" are handled differently, and no warning message like "SONG EXISTS" appears; the transmitted data automatically replaces the original data at the destination.

CHANGING EFFECT PROGRAMS ON THE GW50 FROM A CONNECTED DEVICE

This function lets you change the effect programs of the GW50 remotely from another MIDI device, such as a MIDI keyboard or sequencer. This would come in handy if you are using a keyboard instead of a guitar with the GW50 and want to change programs from the keyboard. It would also be useful if you already have a MIDI sequencer system and want to control the program changes from that sequencer. A MIDI foot controller (such as the Yamaha MFC06 MIDI Foot Controller) can also be used for this purpose.

Operation —

1. Make sure all MIDI connections have been made properly (see connection examples B and C on page 101). Also, make sure that the MIDI transmit channel on the connected device is set to 1. (Refer to the owner's manual of the device for details.)

2. Transmit the program change message from the connected device. The new effect program on the the GW50 should now be selected.

Note:This function can be used from the main modes of the Effect section and any of the Backing section modes.

Note:Refer to the chart "MIDI to GW50 Program Number Correspondence" on page 104, for information on what program numbers to use.

CHANGING PROGRAMS ON A CONNECTED DEVICE FROM THE GW50

This function lets you remotely select programs on another MIDI device, such as on an external sound module or effect unit. Applications of this would include automatically changing programs on a second, supplemental effect unit when changing programs from the GW50 panel. Likewise, it could be used to automatically change sound programs on a guitar synthesizer module as you change programs on the GW50.

Operation —

1. Make sure all MIDI connections have been made properly (see connection example D on page 101). Also, make sure that the MIDI receive channel on the connected device is set to 1 (or OMNI ON). (Refer to the owner's manual of the device for details.)
2. From the Memory mode, change the effect program on the GW50. The program on the connected device should change as well.

Note: Refer to the chart below, "MIDI to GW50 Program Number Correspondence," for information on what program numbers to use.

MIDI to GW50 Program Number Correspondence

Since the program numbering system of the GW50 differs from that of MIDI, the following chart shows which MIDI program number must be transmitted to select the desired effect program on the GW50, and vice versa. Refer to this chart before trying to make any program changes via MIDI.

MIDI	GW50
0-4	11-15
5-9	21-25
10-14	31-35
15-19	41-45
20-24	51-55
25-29	61-65
30-34	71-75
35-39	81-85
40-44	91-95
45-49	01-05

TURNING INDIVIDUAL EFFECTS ON AND OFF FROM A CONNECTED DEVICE

This function lets you turn individual effects on and off from the connected MIDI devices, by using Control Change messages. Applications of this would include automating effect on/off switching from a connected MIDI sequencer. A MIDI foot controller (such as the Yamaha MFC06 MIDI Foot Controller) can also be used for this purpose.

Before using this function, use the operation below to set the Control Change numbers that the GW50 will respond to (91 - 95 or 116 - 120).

Operation —

1. With the power on the GW50 turned off, simultaneously hold down [SHIFT] and turn the power back on again. The following display appears:

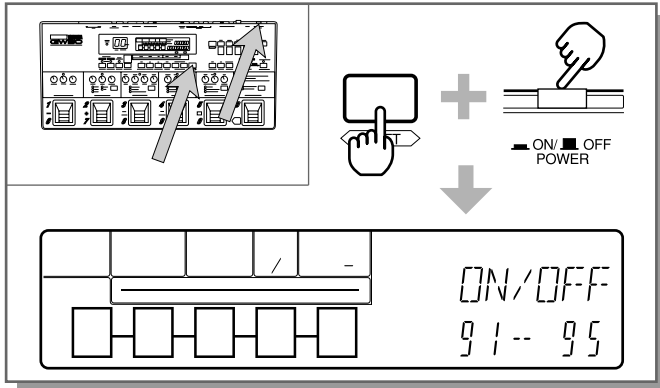

2. Two different sets of Control Change numbers can be used for this operation: 91 – 95, or 116 – 120. Select which set of numbers you wish to use with the [-]/[+] buttons.

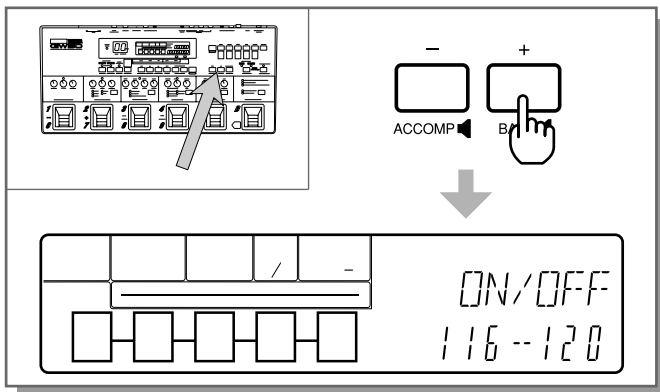

Note: If you are using the Yamaha MFC06 MIDI Foot Controller, set this to 116 – 120. If you are using another device, check the MIDI Implementation of that device to determine which Control Change numbers to use.

3. Press any of the mode buttons ([MANUAL], [MEMORY], or [SONG/PATTERN]) to return to normal operation.

Once you've set the Control Change numbers in the above operation, use the operation below to actually receive Control Change messages on the GW50.

Operation —

1. Make sure all MIDI have been made properly (see connection examples B and C on page 101). Also, set the MIDI transmit channel on the connected device to 1.
2. Transmit a value of 0 with the appropriate Control Change message to turn the desired effect on and off (the transmitted message acts as a toggle switch between on and off). (Refer to the chart below for Control Change number/Effect correspondence.)

Effect	Control Change number
Compressor	92 (or 116)
Distortion	94 (or 117)
Equalizer	95 (or 118)
Chorus	93 (or 119)
Reverb/Delay	91 (or 120)

Note: Control Change messages can be received in the main modes and the Memory Edit mode of the Effect section and any of the Backing section modes.

SYNCHRONIZING ANOTHER DEVICE WITH THE GW50

Since the GW50 transmits MIDI clock messages, you can have a sequencer and connected tone generator play back in perfect time with the Backing parts of the GW50. In this way, you can add other instrumental parts from the tone generator (such as melodies, riffs, etc.) to the accompaniment, bass and drum patterns of the GW50.

Operation —

1. Make sure all MIDI connections have been made properly (see connection example E on page 101).

2. Set the connected rhythm machine or sequencer to receive on one of channels 6 – 16 (1 – 5 should be avoided, since these are used for transmitting program changes and Backing part note data from the GW50). Also, set its operation to “external sync” or the equivalent, (refer to the owner’s manual of the device for details).
3. Now, select a song or pattern on the GW50 and press [START/STOP] to start it. The rhythm machine or sequencer will play back in perfect synchronization with the Backing parts of the GW50.



ADDING SEQUENCER PARTS TO THE GW50’S BACKING—You can record additional parts on the sequencer to match and supplement parts in the song of the GW50. The sequencer can then be synchronized with the GW50 in playback, allowing you to play both the GW50 parts and the sequencer parts at the same time.

Note: Since the GW50 does not, however, respond to incoming clock messages (it has no “external sync” operation), you cannot synchronize and control the GW50 from the connected device.

USING THE BACKING PATTERNS TO PLAY OTHER SOUND MODULES

The accompaniment, bass and drum patterns of the GW50 are stored in the unit as MIDI data, and can be used to play back sounds from connected synthesizers, rhythm machines and sound modules. For example, the GW50 could be hooked up to the Yamaha TG500 Tone Generator, and be used to play the bass, drums, and various accompaniment instrument sounds (such as piano, guitar, organ, etc.) on the TG500, to complement or even replace the Backing sounds of the GW50.

Operation —

1. Make sure all MIDI connections have been made properly (see connection example F on page 101).
2. Make the following settings on the connected instrument (referring to the owner’s manual of that instrument for details):
 - * Set up different instrumental parts (for example, piano, guitar, bass and drums) as part of a multi-timbral program.

* The GW50 transmits accompaniment sounds on channels 2 and 3, bass on channel 4, and drums on channel 5.

Note: Program change messages (effect program changes on the GW50) are transmitted on Channel 1.



MATCHING ACCOMPANIMENT SOUNDS—Since the specific accompaniment instruments differ according to the pattern selected, refer to the Preset Pattern List on page 144; this will help you decide what kinds of accompaniment sounds you should select on your tone generator, depending on the Backing pattern. Refer also to the chart on page 146 for specific drum and percussion sound assignments.

3. Now, select a song or pattern on the GW50 and press [START/STOP] to start it. The Backing tracks will now play on both the GW50 and the connected instrument. (If the BACKING LEVEL is set to 0, only the connected tone generator will sound.)

Note: PROBLEMS WITH PATTERN CHANGES—If there are pattern changes in the song, the accompaniment sounds of the GW50 may change (in an extreme example, from guitar to strings when changing from a rock pattern to a ballad). However, the tone generator will not change but continue to play the accompaniment sound which was set for the start of the song. To get around this problem, follow the hint below and record the accompaniment to a sequencer, then make the necessary program changes from the sequencer.



RECORDING THE GW50'S BACKING TRACKS TO A SEQUENCER—In a variation of the above operation, you could connect a MIDI sequencer to the GW50, and connect the tone generator to the sequencer (as shown in connection example E on page 101), then record the Backing tracks to the sequencer. In this way, you take advantage of the editing functions and conveniences of your sequencer, making program changes and changing the tracks as you like, then playing them back on another sound module. (The Backing sounds of the GW50 cannot be played from another device.)

GW50

APPENDICES

ERROR MESSAGES	111
TROUBLESHOOTING	114
SPECIFICATIONS	117
INDEX	119

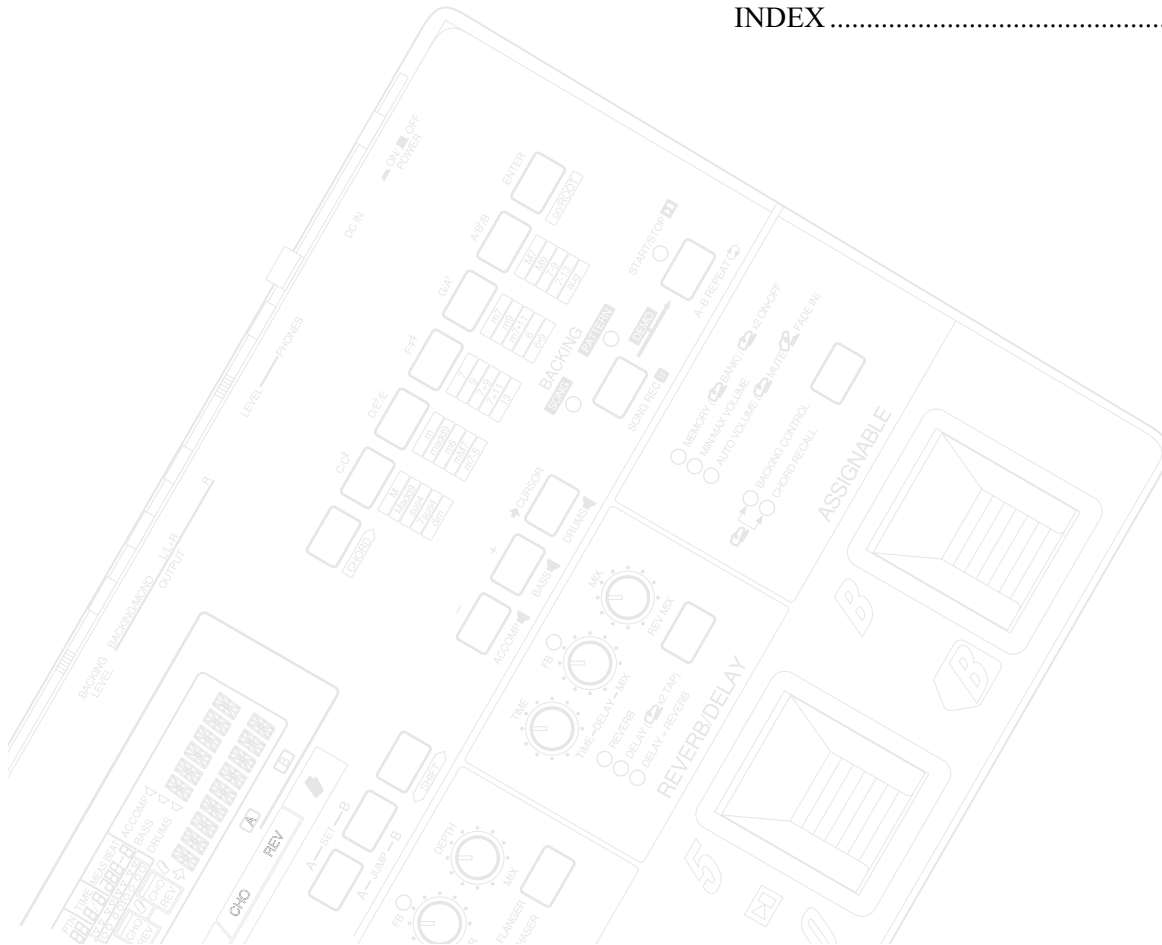



ERROR MESSAGES

The GW50 monitors the battery voltage only once (when the power is turned on), and if there is a problem with the battery, one of the following battery-related error messages will appear.

LOW
BATTERY

This indicates that the voltage of the battery is low. Have the battery changed by Yamaha service personnel as soon as possible (see your nearest Yamaha dealer). (Also refer to “PRECAUTIONS,” page ii.)

HIGH
BATTERY

This indicates that the voltage of the battery may be too high because something is wrong with the battery backup circuit. Have the GW50 serviced by Yamaha service personnel as soon as possible (see your nearest Yamaha dealer).

NOT
AVAILABLE

This indicates that the button pressed is inactive in the current mode.

NO
PARAMETER

This appears when Pedal Wah has been selected in the WAH + EQ effect, and the [L MID/SPEED] knob is adjusted.

NOT
EDITED

This is shown when the Edit Compare function has been selected without any edits having been made in the Memory Edit mode.

EXIT
MEM EDIT

This appears when the Memory Edit mode is active and some other incompatible operation (such as selecting the Bulk Dump or Tuner functions) has been attempted. Exit the Memory Edit mode by pressing [MANUAL] or [MEMORY], and then attempt the operation again. (Keep in mind that doing this stores your recent edits to the current program number.)

EXIT
MEM JOB

This appears when bulk data is received in the Memory Job mode, or when some unavailable operation or function has been attempted in this mode. Exit the mode by pressing any of the mode buttons.

EXIT
SONG JOB

This appears when bulk data is received in the Song Job mode, or when some unavailable operation or function has been attempted in this mode. Exit the mode by pressing any of the mode buttons.

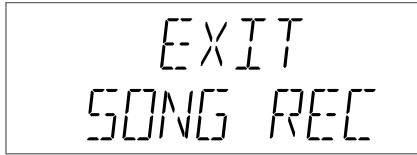

EXIT
SONG REC

This appears when Song recording is in standby and some other incompatible operation (such as selecting the Bulk Dump or Tuner functions) has been attempted. Exit the Song recording by pressing [SONG/PATTERN], and then attempt the operation again.



EXIT
COMPARE

This appears when the Compare condition is still active and some other incompatible operation (such as selecting the Bulk Dump or Tuner functions) has been attempted. Exit the Compare function by pressing [MANUAL] or [MEMORY], and then attempt the operation again. (Keep in mind that doing this recalls the original effect program to the current program number.)



EXIT
TUNER

This appears when bulk data is received or some other incompatible operation is executed while the Tuner function is active. Exit the Tuner mode by pressing any of the mode buttons (or any of the Pedal Switches).

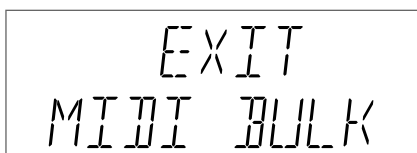

EXIT
MIDI BULK

This appears when bulk data is received or some other incompatible operation is executed in the MIDI Bulk transmission mode.

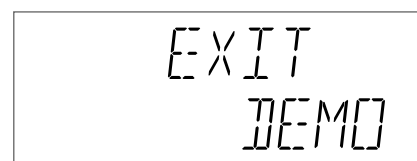

EXIT
DEMO

This appears when bulk data is received or some other incompatible operation is executed while the Demo mode is selected. Exit the Demo mode by pressing any of the mode buttons.

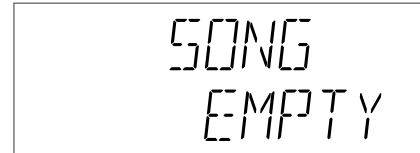

SONG
EMPTY

This appears when attempting to transmit an empty song using the Bulk Dump function, or when attempting to playback an empty song.

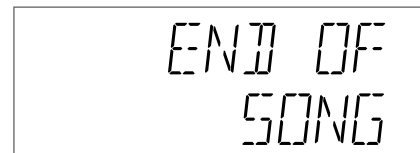

END OF
SONG

This appears when attempting to start a song from a point beyond the end measure.

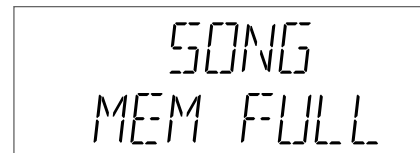

SONG
MEM FULL

This appears when the song memory is full. Delete any unnecessary song or songs.



MEAS
OVERFLOW

This appears when attempting to create a song over the 299-measure limit.

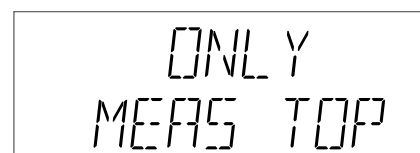

ONLY
MEAS TOP

This appears when attempting to input a pattern number to a position in the song other than the beginning of a measure (in Step recording).



SONG
EXISTS

This appears when bulk data for a song is received and data already exists for the destination song number. Select an empty song or delete the current song.



STOP
PATTERN

This appears when a pattern is playing and some other incompatible operation (such as selecting the Bulk Dump or Tuner functions) has been attempted. Stop the pattern by pressing [START/STOP], and then attempt the operation again.



STOP
SONG

This appears when a song is being played back or recorded and some other incompatible operation (such as selecting the Bulk Dump or Tuner functions) has been attempted. Stop the song by pressing [START/STOP], and then attempt the operation again.



SONG
CLEARED

This appears when song data has somehow been corrupted and made unreadable. The song or songs in memory are cleared automatically. This message appears only once when the power is turned on.



MIDI
BUF FULL

This appears when the MIDI buffer is full (when too much MIDI data is being received at one time). When transmitting Bulk Data from the MIDI storage device (such as the Yamaha MDF2 MIDI Data Filer), set a relatively long interval time between data blocks on that device.

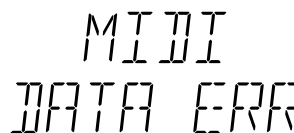

MIDI
DATA ERR

This appears when some error has occurred in data reception or transmission. Check the MIDI cable connections, and then attempt the operation again.

TROUBLESHOOTING

Even though the GW50 is exceptionally easy to use, it may occasionally not function as you expect it to. Note that the problems covered here are not malfunctions of the GW50. (Also refer to the “ERROR MESSAGES” section.)

PROBLEM	POSSIBLE CAUSE AND SOLUTION
The instrument (guitar) sound cannot be heard.	<ul style="list-style-type: none"> ■ Check that all connections have been properly made and that all levels have been appropriately set (including the INPUT LEVEL control on the rear panel). ■ Check that the HEADPHONES LEVEL control has been set to an appropriate level (if using headphones). ■ Check that the Input and Output parameters of the various effects are set to appropriate levels. (In particular, check the sub parameters of the Equalizer block effects.) ■ Make sure that the Effect Mix and Dry Level parameters are set appropriately. When they are set to 0, no sound is output. ■ Make sure that the MIN/MAX Volume function is not active (and that the Minimum Volume setting is not 0). (See page 48.) ■ If an external foot controller is connected, make sure that it is not all the way up (at the minimum setting). ■ Make sure that the Tuner mode or MIDI Bulk Dump functions are not active. (See pages 99 and 102.)
The effect sound cannot be heard or is nearly inaudible.	<ul style="list-style-type: none"> ■ Check all of the above points (for when the instrument sound cannot be heard). ■ Check that the desired effect blocks are turned on (LEDs are lit). ■ Check that the Effect Mix and Dry Level parameters of the Chorus and Reverb/Delay blocks are set to appropriate levels. (See pages 64-69.) ■ Check that other effect parameters (such as Depth in the Chorus, or Reverb Time in Reverb) are set to appropriate levels.
The sound is too loud or the effect sound is abnormal or unexpected.	<ul style="list-style-type: none"> ■ The guitar level is too loud (the INPUT PEAK LED is lit continuously). Set all levels appropriately (see page 21). ■ In general, remember that the parameters within an effect interact with and depend on each other. If you are using more than one effect, try each effect block separately, checking and adjusting all parameters in the effect until you get the sound you want.

PROBLEM	POSSIBLE CAUSE AND SOLUTION
The sound is too loud or the effect sound is abnormal or unexpected.	<ul style="list-style-type: none"> ■ If there is too much distortion or noise, check: <ul style="list-style-type: none"> ● The Output parameters of the effects — especially, Compressor, Distortion and Equalizer. ● The Input parameter of the Equalizer. ● That the Equalizer gain controls (for example, Low and High) have not been set too high. ● That the Effect Mix and Dry Level parameters of the Chorus and Reverb/Delay blocks are set to appropriate levels. ■ Also check your connected amplifier. If you are getting too much distortion, check that the GW50 is connected to the clean channel and not to the distortion channel.
The effect sound doesn't change, even when the parameter knobs are adjusted.	<ul style="list-style-type: none"> ■ Make sure that either the Manual mode or Memory Edit mode has been selected. (Effects cannot be changed in the Memory mode.)
The foot controller volume, ASSIGNABLE block MIN/MAX Volume and the Auto Volume controls do not have any effect.	<ul style="list-style-type: none"> ■ The Minimum Volume is set to 9 (9 equals the maximum volume). Set it to a lower value. (See page 47.)
The ASSIGNABLE Block and Pedal Switch do not function as expected.	<ul style="list-style-type: none"> ■ The functions that are available or called up automatically depend on the selected mode. (See the "ASSIGNABLE Block and Pedal Switch Functions Chart" on page 128.)
In the Delay effect, tapping the Pedal Switch does not set the expected delay time (Tap Delay function).	<ul style="list-style-type: none"> ■ In tapping the Pedal Switch, make sure that the time between taps is not longer than the maximum delay time (896 ms). (See pages 67-68.)
<hr/> <p>Note: If you tap the Pedal Switch a little beyond the maximum time (up to about one second), the delay time will be set. However, taps longer than one second may not register at all.</p> <hr/>	
<ul style="list-style-type: none"> ■ For the Tap Delay function to be effective, 1) the REVERB/DELAY block must be on, 2) Delay (or Delay + Reverb) must be selected for the effect type, and 3) the MEMORY ON/OFF function in the ASSIGNABLE Block must be on (the LED flashes). 	
A selected song or pattern does not play, even when [START/STOP] is pressed.	<ul style="list-style-type: none"> ■ In the case of song playback, make sure that the selected song is not empty. ■ In the case of either song or pattern playback, make sure that the Tuner mode or MIDI Bulk Dump functions are not active. If one of them is, press [SONG/PATTERN] to return to the Song or Pattern mode.

PROBLEM	POSSIBLE CAUSE AND SOLUTION
The Backing sounds cannot be heard.	<ul style="list-style-type: none">■ Check that all connections have been properly made and that the BACKING LEVEL control has been appropriately set.■ Check that the HEADPHONES LEVEL control has been set to an appropriate level (if using headphones).■ Check that the Backing tracks have not been muted. (See page 76.)
Song playback stops before the end of the song.	<ul style="list-style-type: none">■ Move to the last event of the song check what that event is; you may have to enter another "ending" event to the song for it to end as you intended. (See hint #1 on page 87.)
Song playback (or recording) only continues for a few measures and repeats those measures over and over.	<ul style="list-style-type: none">■ The A-B Repeat function is active. Turn it off by simultaneously pressing [SHIFT] and [A-B REPEAT]. (See pages 92~93.)
During song playback, even though the A-B Repeat function is active (the repeat mark is displayed in the LCD), the selected measures do not repeat.	<ul style="list-style-type: none">■ Playback must be started before the B measure for the A-B Repeat function to work. (See page 93.)■ The A/B measure setting may have changed if you've last used the Copy or Delete functions.
When using one of the metronome patterns, chords cannot be heard or entered.	<ul style="list-style-type: none">■ This is normal; the metronome pattern was designed for using alone, without chord or bass accompaniment. (See note in step #2, page 84.)
Pattern number 248 does not sound.	<ul style="list-style-type: none">■ This is normal; pattern number 248 is a blank pattern designed for inserting blank measures into a song.
MIDI bulk data cannot be received by the GW50; or, when transmitting from the GW50 to another device, the other device cannot receive bulk data.	<ul style="list-style-type: none">■ Check all MIDI connections and settings on both devices, then try the operation again. (See pages 101, 102.)
The LCD cannot be read.	<ul style="list-style-type: none">■ Use the LCD SETTING switch on the rear panel to set the LCD for proper viewing. Set it to FLOOR when you are using the GW50 on the floor, and to DESKTOP when you have it set on a table or desk in front of you.
The LCD is completely dark.	<ul style="list-style-type: none">■ Leaving the GW50 in environments with temperatures over 50°C (122°F) causes the LCD to turn completely black. If this happens, you can make the LCD readable again by putting the GW50 in a cool location.

SPECIFICATIONS

EFFECT SECTION

Memory

1 Manual effect and 50 Memory effect programs (factory-set/user-programmable)

Effect Types

Compressor
 Distortion Distortion 1 – 4, Overdrive
 Equalizer 4-band Equalizer, Wah (Auto/Touch/Pedal) + 2-band Equalizer, Amp Simulator (Stack/Combo/Tube) + 2 band Equalizer
 Chorus Chorus 1, 2, Pitch Shifter, Flanger, Phaser
 Reverb/Delay Reverb, Delay (Tap), Delay + Reverb
 Noise Gate

Effect Functions

Combination/order of Compressor, Distortion and Equalizer effects; combination/order of Chorus and Reverb/Delay effects
 Group/individual on/off (with Pedal Switches)
 Tap Delay control
 Min/Max Volume, Auto Volume
 Parameter control (with optional foot controller)
 Effect program Bank/Number selection (with -/+ buttons or Pedal Switches)

BACKING SECTION

Tone Generation

AWM (Advanced Wave Memory)

Preset Patterns

248 (60 styles × 4 variations, plus 8 special patterns; Accompaniment, Bass and Drums parts with independent on/off switching)

Chord Types

25

Songs

8 (7 × factory-set, 1 × blank; all user-programmable)

Record Modes

Realtime, Step

Data Capacity

8 songs, 299 measures/song, approximately 4000 chord events for all 8 songs

Backing Functions

Pattern/accompaniment control with Pedal Switches (song/pattern select, start/stop, measure reverse (n)/forward (m), Fill In, Ending, Chord Recall) Root Select and Triggered Run (from guitar input)

TUNER SECTION

Chromatic auto tuner

GENERAL

Display

Custom large backlit LCD (with adjustable contrast) and 7-segment, 2-digit bank/memory number LED, input peak LED

Input Jacks

Instrument input (INPUT)
 -17 dBm (1 Mohm), mono, phone jack
 Foot Controller
 Footswitch (FOOT SW)

Output Jacks

Instrument outputs (OUTPUT: L/L+R, R), stereo/mono, phone jack
 0 dBm (10 Kohm or greater)
 Backing output (OUTPUT: BACKING/MONO), mono, phone jack
 +3 dBm (10 Kohm or greater)
 Headphones (PHONES)
 10 mW/47 ohm, stereo, stereo phone jack

MIDI Terminals

MIDI IN, MIDI OUT

Other Controls, Fittings

Input level, Backing output level, headphones level, LCD contrast switch (LCD SETTING), DC IN jack, power switch, AC adaptor cord holder

Power Supply

Supplied PA-3 AC adaptor

Dimensions (W × D × H)

499 × 230 × 56 mm (19 5/8" × 9" × 2 1/4")

Weight

2.4 kg (5 lbs., 5 oz.)

Supplied Accessories

PA-3 AC adaptor, owner's manual

Optional Accessories

FC5 (or FC4) Footswitch, FC7 Foot Controller

Note: Specifications and appearance subject to change without notice.

INDEX

- A**
- Accompaniment part 76
- AMD 64
- Amp Simulator + EQ 63
- ASSIGNABLE Block and Pedal Switch functions
- in Memory mode 11, 51
 - in Pattern mode 12, 77
 - in Realtime recording 13, 86
 - in Song mode 13, 77, 86
- ASSIGNABLE Block Pedal Switch, using to switch
- between Backing Control and Chord Recall 13, 77
- ASSIGNABLE Block volume control, setting minimum
- volume level for (MIN VOL) 47
- ASSIGNABLE Block, LED indicators 10
- Attack 58
- audio connection examples 19-20
- Auto (Wah + EQ) 62
- auto volume 48
- auto volume rate (AUTO VOL) 49
- B**
- Backing Control
- in Pattern mode 12, 77
 - in Song mode 13, 82
- banks, changing 51
- Basic patterns 73
- bass note, changing 35, 75, 88
- Bass part 76
- Blank pattern 73
- Brilliance 64
- bypass switching 52
- C**
- cable clip 15
- Center Frequency 62
- changing chord type 75
- changing chords 74
- chord changes, recording in realtime 85
- Chord Recall 12, 13, 77, 86
- chord types
- changing 34
 - list of 76, 152
- chords
- assigning to the Pedal Switches 78
 - changing bass note 75
 - changing chord type 75
 - changing during playback of pattern 33
 - changing in Pattern mode 74
 - changing root note 74
 - selecting with ASSIGNABLE Block and Pedal Switches (Chord Recall) 12, 13, 77, 86
- Chorus 1, 2 64
- Chorus block 63
- Compare mode 29, 53
- Compressor block 58
- CONNECT 45
- connection examples
- audio 19-20
 - MIDI 101
- copying an effect program 54
- copying measures 94
- cursor arrow
- moving in Pattern mode 74
 - moving in Song mode 80
- D**
- data
- saved to an effect program 50
 - types and methods of entering in Realtime recording 83
 - types and methods of entering in Step recording 89
- Delay 67
- Delay + Reverb 68
- Delay Dry Level (Delay + Reverb) 68
- Delay Effect Mix (Delay + Reverb) 68
- Delay Feedback (Delay + Reverb) 68
- Delay Time (Delay + Reverb) 68
- deleting
- a single song 95
 - measures 94
- Demo mode 22
- Depth (Chorus 1, 2) 64
- Depth (Flanger) 65
- Depth (Phaser) 66
- Dist 1 – 4 59
- Distortion block 59
- Doubling Balance 68
- Doubling Balance (Delay + Reverb) 68
- Doubling Time 68
- Doubling Time (Delay + Reverb) 68
- Drive 59
- Drums part 76
- Dry Level (Chorus 1, 2) 64
- Dry Level (Delay) 68
- Dry Level (Flanger) 66
- Dry Level (Phaser) 66
- Dry Level (Pitch Shift) 65
- Dry Level (Reverb) 67

E	
editing effect parameters, in Manual mode	44
editing recorded events	92
effect blocks	24
effect blocks	
bypass switching (GROUP)	45
determining the order (CONNECT)	45
turning on and off	44
Effect Mix (Chorus 1, 2)	64
Effect Mix (Delay)	68
Effect Mix (Flanger)	65
Effect Mix (Phaser)	66
Effect Mix (Pitch Shift)	64
Effect Mix (Reverb)	67
effect on/off (bypass) data, recording in realtime	85, 86
effect on/off (bypass) switching	52
effect program data, recording in realtime	85
effect programs	
comparing edited program with original	29, 53
copying	54
data saved to	50
naming	55
recalling original	30, 54
restoring factory preset	57
saving	30, 50, 53
selecting in Memory mode	51
selecting with ASSIGNABLE Block and Pedal Switches	51
swapping	55
effect type, selecting	44
effects	
changing (editing) in Manual mode	26
changing (editing) in Memory mode	29
End Pedal Switch	77
Ending pattern	73
EQ High (Amp Simulator + EQ)	63
EQ High (Wah + EQ)	62
EQ High Frequency (Amp Simulator + EQ)	63
EQ High Frequency (Wah + EQ)	62
EQ Input (Amp Simulator + EQ)	63
EQ Input (Wah + EQ)	62
EQ Low (Amp Simulator + EQ)	62
EQ Low (Wah + EQ)	62
EQ Low Frequency (Amp Simulator + EQ)	63
EQ Low Frequency (Wah + EQ)	62
EQ Output (Amp Simulator + EQ)	63
EQ Output (Wah + EQ)	62
Equalizer	60
Equalizer block	59
erasing (deleting) a song	95
erasing recorded events	92
event indicator	79

F	
Feedback (Delay)	68
Feedback (Flanger)	65
Feedback (Phaser)	66
Feedback (Wah + EQ)	62
fill in pattern	33
Fill in patterns	73, 77
Fill Pedal Switch	77
Flanger	65
FOOT	46
foot controller	
setting (FOOT)	46
setting minimum volume level for (MIN VOL)	47
using as a volume pedal	46
using as a wah pedal	47, 61
using for control of Chorus Depth	47
using for control of Distortion Drive	47
using for control of Reverb Feedback	47
using for control of Reverb Mix	47
footswitch (external)	
using as total effect bypass switch	57
using instead of certain panel controls	56

G	
GROUP	45

H	
High (Equalizer)	60
High (Reverb)	67
High Frequency	61
High Mid	60
High Mid Frequency	60
High Mid Q	60

I	
Input (Equalizer)	60

L	
Left Delay Feedback	65
Left Delay Time (Pitch Shift)	64
Left Delay Time (Flanger)	65
Loop playback	92
Loop recording	93
Low (Equalizer)	60
Low (Reverb)	67
Low Frequency	60
Low Mid	60
Low Mid Frequency	60
Low Mid Q	60

- M**
- Manual Job mode 2, 50
- Manual mode 2, 43, 44-49
- Manual mode settings, saving to an effect program 50
- measure A/B
- checking current settings 92
 - copying 94
 - deleting 94
 - jumping to 92
 - Loop playback 92
 - Loop recording 93
 - marking 92
 - using to delete a single song 95
- measure/event section 79, 81
- Memory Edit mode 2, 43, 53-54
- Memory Edit mode settings, saving to an effect program 53
- Memory Job mode 2, 54-57
- Memory mode 2, 43, 51-52
- Metronome patterns 73
- MIDI**
- Bulk Transmission mode 102
 - changing effect programs on connected device
 - from GW50 104
 - changing effect programs on GW50 from
 - connected device 103
 - connection examples 101
 - Control Change number to effect correspondence 106
 - Control Change numbers 104-105
 - MIDI clock messages 106
 - MIDI to GW50 program number correspondence 104
 - restoring GW50 data from MDF2 MIDI Data
 - Filer 103
 - storing GW50 data to MDF2 MIDI Data Filer 102
 - synchronizing another device with GW50 105
 - transmit channels for Backing parts and effect
 - program changes 107
 - turning effects on and off from connected device 104
 - types of transmitted data 102
 - using patterns to play connected sound modules 106
- MIN VOL 47
- minimum/maximum (MIN/MAX) volume 48
- Mix Balance (Amp Simulator + EQ) 63
- multiple events, display of 91
- muting accompaniment
 - bass and drums parts in Pattern mode 76
 - bass and drums parts in Song mode 80, 86, 88
- muting data (Backing mute status),
 - recording in realtime 85, 86
- N**
- naming an effect program 55
- naming songs 95
- Noise Gate 31, 69
- O**
- Output (Compressor) 58
- Output (Distortion) 59
- Output (Equalizer) 61
- Overdrive 59
- P**
- parameter values, checking 51
- parameters
 - main 44
 - sub 44
- Pattern Demo 22
- Pattern mode 2, 32, 73
- patterns
 - selecting and playing 73
 - selecting with ASSIGNABLE Block and Pedal Switches (Backing Control) 77
- Pedal (Wah + EQ) 62
- Pedal Switch functions 11-13
- Pedal Switches
 - using for Backing Control 12, 13, 77, 86
 - using for Chord Recall 12, 13, 77, 86
 - using for effect on/off (bypass) switching 11, 52
 - using to select effect bank/program numbers 11, 25
- Phaser 66
- Pitch Left 64
- Pitch Right 64
- Pitch Shift 64
- playing songs 36
- Position Controls 81
- Position Controls
 - using to pause Realtime recording 84, 87, 88
 - using to view recorded events 81, 90
- position indicator 79
- R**
- Range (Wah + EQ) 62
- Realtime recording 37, 83
- Realtime recording and Step recording, using together 89
- Realtime recording
 - hints 87
 - Loop recording 93
 - overdub technique 87
 - pausing 84, 87, 88
 - recording chord changes 85
 - recording from middle of song 87
 - types and methods of entering data 83
- recalling preset effect program during editing 30

recorded events
 editing 92
 erasing 92
 viewing 90
 recording chord changes 85
 recording songs 36
 recording
 Backing mute events 83, 85, 86, 89
 chord changes 83, 85, 89
 effect on/off settings 83, 85, 86
 effect program numbers 83, 85
 entering mute, effect program and
 effect on/off events at start of song 85
 patterns 83, 89
 restoring factory preset effect programs 57
 restoring factory preset songs 95
 Retrigger function 73, 88
 Reverb Dry Level (Delay + Reverb) 69
 Reverb Effect Mix (Delay + Reverb) 68
 Reverb High (Delay + Reverb) 69
 Reverb Low (Delay + Reverb) 69
 Reverb Time (Delay + Reverb) 69
 Reverb Type (Delay + Reverb) 69
 Reverb/Delay block 67
 Right Delay Feedback 65
 Right Delay Time (Pitch Shift) 65
 Right Delay Time (Flanger) 66
 root note of chord, changing 34
 root note, changing 74
 Root Select 78

S

saving edited effect program 30
 saving Manual mode settings to an effect program 50
 saving Memory Edit mode settings to an effect program .. 53
 selecting effect programs in Memory mode 51
 Sense (Compressor) 58
 Sense (Wah + EQ) 61
 Set-A and Set-B operations 92
 Song Demo 22
 Song Edit mode 90
 song editing 90
 Song Job mode 94
 Song mode 2, 36, 79
 songs
 erasing (deleting) 95
 naming 95
 empty, checking for 84
 factory preset, restoring 95
 list of 147
 maximum length and size (recorded events) 83
 selecting and playing 79

selecting with ASSIGNABLE Block and
 Pedal Switches (Backing Control) 82
 playback 36
 recording 36, 83, 88
 Speed (Chorus 1, 2) 64
 Speed (Flanger) 66
 Speed (Phaser) 66
 Speed (Wah + EQ) 62
 Step recording 37, 88
 Step recording and Realtime recording, using together 90
 Step recording, types and methods of entering data 88
 swapping an effect program 55
 switching between Backing Control and Chord Recall
 with ASSIGNABLE Block Pedal Switch 77

T

Tap Delay 67, 68
 tempo
 changing in Pattern mode 76
 changing in recording and playback 83
 changing in Song mode 80
 Threshold 69
 Time (Delay) 67
 Time (Reverb) 67
 Tone 59
 Touch Fast 62
 Touch Slow 62
 Triggered Run 82
 Tuner 39, 99
 tuning indications 99
 Type (Amp Simulator + EQ) 62
 Type (Reverb) 67
 Type (Wah + EQ) 61

U

utility functions 45

V

Variation patterns 73
 viewing recorded events 90
 volume, auto 48
 volume, minimum/maximum (MIN/MAX) 48

W

Wah + EQ 61
 Wah Pedal 61



GW50

SUPPLEMENTAL INFORMATION

BLOCK DIAGRAM	125	DRUM AND PERCUSSION SOUNDS USED FOR DRUM PARTS	146
JOB TABLE	126	FACTORY SET SONG LIST	147
ASSIGNABLE BLOCK AND PEDAL SWITCH FUNCTIONS CHART	128	MIDI SPECIFICATIONS	148
EFFECT PARAMETER CHART	130	MIDI IMPLEMENTATION CHART	150
FACTORY SET MEMORY EFFECT PROGRAM LIST	132	CHART OF CHORD FINGERINGS FOR GUITAR	152
MEMORY EFFECT PARAMETER LIST	133	USE OF ADVANCED RECORDING TECHNIQUES – FACTORY SET SONG 1	153
MANUAL EFFECT FACTORY SET PARAMETER CHART	143	DEMO SONGS 1-6 – CHORD CHARTS	156
PRESET PATTERN LIST	144		



BLOCK DIAGRAM

JOB TABLE

JOB TABLE * In this chart, a plus mark between two button names (for example, **SHIFT + SUB PARAM**) indicates that the two are to be pressed simultaneously. An arrow between buttons (for example, **CURSOR → - [] + []**) indicates that they are to be pressed in sequence.

* **MANUAL**—Main modes

EFFECT SECTION

active at the same time

BACKING SECTION

MANUAL mode— MANUAL

- Editing main parameters—Parameter knobs
- Editing sub parameters and Noise Gate—**SHIFT** + **SUB PARAM** → Effect Selector buttons
- Utility functions—Effect Utility switch
 - CONNECT
 - GROUP
 - FOOT (Foot Controller)
 - MIN VOL (Minimum Volume) @
 - AUTO VOL (Auto Volume)

ASSIGNABLE block functions

- Effect ON/OFF
- MIN/MAX VOLUME
- AUTO VOLUME

MEMORY mode— MEMORY

- Effect program selection—**CURSOR** → **- [] / [] +**

ASSIGNABLE block functions

- MEMORY BANK/NUMBER selection
- Effect ON/OFF
- MIN/MAX VOLUME
- AUTO VOLUME

PATTERN mode— SONG/PATTERN

- Pattern selection & playback—**CURSOR** → **- [] / [] +** **START/STOP**
- Chord entry (change)—**CHORD**, Chord buttons, **ON/ROOT**
- Mute on/off—**SHIFT** + **ACCOMP** / **BASS** / **DRUMS**

ASSIGNABLE block functions

- BACKING CONTROL
- CHORD RECALL
- Root Select—Pedal switch **B** + Note played on guitar

SONG mode (Play/Step Recording/Edit)

- Song selection and playback—**CURSOR** → **- [] / [] +** **START/STOP**
- Step recording (recordable data types)
 - Chords
 - Mute
 - Patterns
 - Make setting(s) & press **ENTER**
- Edit
 - "A"/"B" Location Set—Position Controls → **SET-A** / **SET-B**
 - Jumping to "A"/"B"—**SHIFT** + **JUMP-A** / **JUMP-B**
 - (Loop Recording/Loop Play)—**SHIFT** + **A-B REPEAT**
 - Erase—**SHIFT** + **ERASE**

ASSIGNABLE block functions

- BACKING CONTROL
- Triggered Run—Pedal switch **B** + Pedal Switch 5 → Note played on guitar

TUNER mode— SHIFT + TUNER

- Tuning
- Center pitch adjustment

MIDI BULK TRANSMISSION mode— SHIFT + MIDI BULK

- MIDI bulk transmission

DEMO mode— SONG/PATTERN + START/STOP

- Song demo play (with effect changes)
- Pattern demo play (with effect changes)

JOB mode

- WRITE (Save)—[MANUAL] + [MEMORY]

ASSIGNABLE block functions

- Effect ON/OFF
- MIN/MAX VOLUME
- AUTO VOLUME

EDIT mode—[EDIT/COMPARE]

- Same as MANUAL mode (including ASSIGNABLE block functions)
- + Save—[MANUAL] or [MEMORY]

COMPARE mode—[EDIT/COMPARE]

- Comparing with original effect
- Recalling original effect—[MANUAL] or [MEMORY]

ASSIGNABLE block functions

- MIN/MAX VOLUME
- AUTO VOLUME

JOB mode

- COPY
- SWAP
- NAME

} <SHIFT> + [COPY/NAME]

ASSIGNABLE block functions

- MIN/MAX VOLUME
- AUTO VOLUME

• Factory set recall

REALTIME RECORDING mode—<SHIFT> + [SONG REC]

- Realtime recording (recordable data types)
 - (Pattern)
 - Chords
 - Mute
 - Effect Program Number
 - Effect on/off

} Enter data as song is playing (— [START/STOP])

ASSIGNABLE block function

- CHORD RECALL

JOB mode

- COPY—<SHIFT> + [MEAS COPY]
- DELETE—<SHIFT> + [MEAS DEL]
- NAME—<SHIFT> + [SONG NAME]

ASSIGNABLE block function

- BACKING CONTROL (only measure <LEFT> / <RIGHT> available)

• Factory set recall

Other Functions

- MIDI functions : Program Change (Effect change) reception
 - : Program Change (Effect change) transmission
 - : Control Change (Effect on/off) reception
 - : Clock transmission
 - : Note on/off (for Backing parts) transmission
- External Footswitch function assignments—External Foot switch + appropriate switch/button (for <SHIFT> <TUNER> ASSIGNABLE Block Type switch, [START/STOP] etc; see page 56.)
- Tempo change (in Backing modes)—<CURSOR> → [] / [+]
- LCD contrast adjustment—[LCD SETTING]

ASSIGNABLE BLOCK AND PEDAL SWITCH FUNCTIONS CHART

This chart indicates the availability of the AS-SIGNABLE block functions for the various modes of the GW50. The shaded sections indicate settings that are automatically selected when the corresponding mode buttons are pressed.

The BANK/NUMBER select or ON/OFF settings and the MIN/MAX VOLUME or AUTO VOLUME settings can be used simultaneously (the LEDs of both will be lit or flash). BACKING CONTROL and CHORD RECALL are independent and cannot be used simultaneously. Also, Pedal Switches 1–5 are applicable, except for MIN/MAX VOLUME and AUTO VOLUME (which are controlled by the ASSIGNABLE Block Pedal Switch).

ASSIGNABLE Block Function	Mode						
	Manual	Manual Job	Memory	Memory Edit	Memory Edit Compare	Memory Job	
MEMORY: BANK/NUMBER Select	× ₁	× ₂	○ ₃ or ○ ₃	× ₄	× ₅	× ₆	
ON/OFF	○ ₇	○ ₈	○ ₉	○ ₁₀	× ₁₁	× ₁₂	
MIN/MAX VOLUME	○ ₁₃	○ ₁₄	○ ₁₅	○ ₁₆	○ ₁₇	○ ₁₈	
AUTO VOLUME	○ ₁₉	○ ₂₀	○ ₂₁	○ ₂₂	○ ₂₃	○ ₂₄	

ASSIGNABLE Block Function	Mode				
	Pattern	Song	Song Realtime Recording	Song Job	
BACKING CONTROL	○ ₂₅	○ ₂₆	× ₂₇	○ ₂₈	
CHORD RECALL	○ ₂₉	× ₃₀	○ ₃₁	× ₃₂	

For 7, 8, 10, 28, 31 —

The ASSIGNABLE Block Pedal Switch has no function.

For 3, 9 —

Pressing [**MEMORY**] calls up either BANK/NUMBER select or ON/OFF, depending on which was last selected with the Pedal Switch (pressing twice selects ON/OFF; pressing once selects BANK/NUMBER).

For 15, 21 —

The ASSIGNABLE Block Pedal Switch is used for MIN/MAX VOLUME or AUTO VOLUME and cannot be used for BANK select or switching between BANK/NUMBER select and ON/OFF.

For 5, 6, 11, 12 —

Despite the LED being lit (or flashing), these functions are not available.

For 28 —

Only measure reverse (n) and forward (m) are available.

For 25, 26 —

The functions of Pedal Switches 1–5 differ between the two settings. The functions also differ between song/pattern playback and stopped conditions.

For 29 —

The functions of Pedal Switches 1–5 are the same for pattern playback and stopped conditions.

For 25, 29 —

The ASSIGNABLE Block Pedal Switch can be used to switch between the two settings, and (when held down) can be used for the Root Select function.

For 26 —

The ASSIGNABLE Block Pedal Switch (when held down) can be used for the Triggered Run function.

This chart shows how pressing various Pedal Switches affects some specific operations.

If the ASSIGNABLE Block is set to:	... in the condition below:	... and one of the following Pedal Switches is pressed:	... the following result occurs:
BACKING CONTROL	When attempting a Memory Job mode operation (with the Pattern or Song mode selected).	Pedal Switches 1, 2 (song/pattern number selected)	The selected song or pattern is called up and the Job operation is aborted (operation returns to Memory mode).
MEMORY BANK/NUMBER	When attempting a Song Job mode operation (with the Memory mode selected).	Pedal Switches 1–5, ASSIGNABLE Pedal Switch (effect program bank/number select)	The Job operation is aborted and operation returns to Song mode).
CHORD RECALL	When attempting a Memory Job mode operation (with the Pattern or Realtime Recording mode selected).	Pedal Switches 1–4 (chord select)	The Job operation is aborted and operation returns to Memory mode. (Realtime Recording is also still active if this had been selected.)

EFFECT PARAMETER CHART

Note: For this chart and the ones on pages 131 and 133-143, sub parameters are denoted by the shaded sections.

Effect	Effect Type	Parameter	Range		
Compressor	Comp	Attack	1~14		
		Sense	-6~-42dB		
		Output	0~200%		
Distortion	Dist1~4, Od	Drive	0~100%		
		Tone	-16~+16		
		Output	0~100%		
Equalizer	Equalizer	Low Gain	-15~+15dB		
		Low Middle Gain	-15~+15dB		
		High Middle Gain	-15~+15dB		
		High Gain	-15~+15dB		
		Input	0~100%		
		Low Frequency	40~1.2kHz		
		Low Mid Frequency	80~12.0kHz		
		High Mid Frequency	80~12.0kHz		
		High Frequency	500~12.0kHz		
		Low Mid Q	0.1~5.0		
		High Mid Q	0.1~5.0		
		Output	0~200%		
		Wah+EQ	Type	Touch Slow	
				Touch Fast	
	Auto				
	Pedal				
	Sense (Touch types)		1~10		
	Speed (Auto type) (no parameter for Pedal type)		0.4~6.4Hz		
	Center Frequency		125~9.0kHz		
	Range		0~28		
	Feedback		0~100%		
	EQ Input		0~100%		
	EQ Low Gain		-15~+15dB		
	EQ Low Frequency		40~1.2kHz		
	EQ High Gain		-15~+15dB		
	EQ High Frequency	500~12.0kHz			
	EQ Output	0~200%			
Amp Simulator+EQ	Type	Stack			
		Combo			
		Tube			
	EQ Low Gain	-15~+15dB			
	EQ High Gain	-15~+15dB			
	Mix Balance	0~100%			
	EQ Input	0~100%			
	EQ Low Frequency	40~1.2kHz			
	EQ High Frequency	500~12.0kHz			
	EQ Output	0~200%			
Chorus	Chorus1	Speed	0.03~6.18Hz		
		Brilliance	-3~+6dB		
		Depth	0~100%		
		Mix	0~100%		
		AMD (Chorus1 only)	0~100%		
	Chorus2	Dry	0~100%		
		Speed	0.03~6.18Hz		
		Brilliance	-3~+6dB		
		Depth	0~100%		
		Mix	0~100%		
	Pitch Shifter	Dry	0~100%		
		Pitch L	-1200~+1200 cent		
		Pitch R	-1200~+1200 cent		
		Mix	0~100%		

Effect	Effect Type	Parameter	Range	
		L Delay Time	0.1~10 ms	
		L Delay FB	0~99%	
		R Delay Time	0~10 ms	
		R Delay FB	0~99%	
		Dry	0~100%	
	Flanger	Speed	0.03~6.18Hz	
		Feedback	0~100%	
		Depth	0~100%	
		Mix	0~100%	
		L Delay Time	0.1~12 ms	
		R Delay Time	0.1~12 ms	
	Phaser	Dry	0~100%	
		Speed	0.03~6.18Hz	
		Feedback	0~100%	
		Depth	0~100%	
	Reverb/Delay	Reverb	Mix	0~100%
			Type	Hall Room Plate
Low Gain			-3~+6dB	
Dry			0~100%	
Delay (Tap)			Time	7~896 ms
			Feedback	0~100%
		Mix	0~100%	
		Doubling Time	30~50 ms	
		Doubling Balance	0~100%	
		Dry	0~100%	
Delay+Reverb		Delay+Reverb	Delay Time	4~512 ms
			Delay Mix	0~100%
		Reverb Mix	0~100%	
		Delay Feedback	0~100%	
		Doubling Time	30~50ms	
		Doubling Balance	0~100%	
		Delay Dry	0~100%	
		Reverb Type	Hall Room Plate	
		Reverb Time	0.3~10.0 sec	
		Reverb Low Gain	-3~+6dB	
Reverb High	0.1~1.0			
Reverb Dry	0~100%			
Utility Settings	Connect	cmp, dst, eq, cho, rev		
	Group	cmp, dst, eq, cho, rev		
	Foot Controller	vol pedal, wah pedal, dst drive, cho depth, rev fb, rev mix		
	Minimum Volume	0~9		
	Auto Volume	1~10		
Noise Gate		0~9		

Effect Parameter Blank Chart

Copy this page and use it for keeping records of your own original parameter settings.

Effect	Effect Type	Parameter	Range		
Compressor	Comp	Attack			
		Sense			
		Output			
Distortion	Dist1~4, Od	Drive			
		Tone			
		Output			
Equalizer	Equalizer	Low Gain			
		Low Middle Gain			
		High Middle Gain			
		High Gain			
		Input			
		Low Frequency			
		Low Mid Frequency			
		High Mid Frequency			
		High Frequency			
		Low Mid Q			
		High Mid Q			
		Output			
		Wah+EQ	Type		
	Sense (Touch types)				
	Speed (Auto type)				
	(no parameter for Pedal type)				
	Center Frequency				
	Range				
	Feedback				
	EQ Input				
	EQ Low Gain				
	EQ Low Frequency				
	EQ High Gain				
	EQ High Frequency				
	EQ Output				
	Amp Simulator+EQ	Type			
		EQ Low Gain			
EQ High Gain					
Mix Balance					
EQ Input					
EQ Low Frequency					
EQ High Frequency					
EQ Output					
Chorus	Chorus1	Speed			
		Brilliance			
		Depth			
		Mix			
		AMD (Chorus1 only)			
	Dry				
	Chorus2	Speed			
		Brilliance			
		Depth			
		Mix			
		Dry			
	Pitch Shifter	Pitch L			
		Pitch R			
Mix					

Effect	Effect Type	Parameter	Range
		L Delay Time	
		L Delay FB	
		R Delay Time	
		R Delay FB	
		Dry	
	Flanger	Speed	
		Feedback	
		Depth	
		Mix	
		Dry	
	Phaser	Speed	
		Feedback	
		Depth	
		Mix	
Dry			
Reverb/Delay	Reverb	Time	
		High	
		Mix	
		Type	
		Low Gain	
		Dry	
	Delay (Tap)	Time	
		Feedback	
		Mix	
		Doubling Time	
		Doubling Balance	
	Delay+Reverb	Delay Time	
		Delay Mix	
		Reverb Mix	
		Delay Feedback	
		Doubling Time	
		Doubling Balance	
		Delay Dry	
Reverb Type			
Reverb Time			
Reverb Low Gain			
Reverb High			
Reverb Dry			
Utility Settings	Connect		
	Group		
	Foot Controller		
	Minimum Volume		
	Auto Volume		
Noise Gate			

FACTORY SET MEMORY EFFECT PROGRAM LIST

	Styles	Loc.	Name	Note	Foot Controller Function
1	American Hard Rock	11	SO FAT	Fat distortion for hard rock	Volume
		12	POPTOP	Tight, bright distortion with chorus and delay	Volume before Distortion
		13	CHINA	Overdrive with rhythmic delay	Reverb Mix
		14	TALKBX	Fat distortion with Touch Wah	Volume
		15	BIGBOT	Fat distortion with detuning and delay	Volume
		21	HIWAY	Straight "crunch" distortion	Distortion Drive
		22	ALIEN	Heavy distortion for solos	Volume
		23	CROWS	Tight distortion	Volume
		24	DRYBAK	Dry distortion for backing parts	Volume
		25	SWIRL	Soft, clean sound with chorus and delay	Volume
2	Heavy Metal	31	METAL	Fat and warm metal distortion	Volume
		32	DRIVER	Tight, dry metal distortion, with small room ambience	Reverb Mix
		33	TOKYO	Hard, bright metal distortion	Volume
		34	TOUCH	Metal distortion with Touch Wah	Volume
		35	WOMEN	Clean, bright sound for rhythm parts	Volume
3	Funk & Jazz	41	JAZZY	Clean jazz sound, with small room ambience	Volume
		42	FUNKY	Slow phase sound for funky "chicken scratching," etc.	Phaser Depth
		43	COMP+D	American rock/fusion sound, with long delay, reverb	Volume
		44	QUACK	Dry, funky phase sound with Touch Wah	Volume
		45	SKANK	Clean sound for funky rhythm parts	Volume
4	British Progressive Rock	51	PROGRE	Warm "fuzz" distortion, with long delay	Volume
		52	OWNER	Distortion with fifths (in octaves) for solos	Volume
		53	BREATH	Clean sound with short delay and heavy chorus	Volume
		54	MYSTRY	Distortion with Touch Wah and long delay	Volume
		55	CHURCH	Three-octave pitch shift sound	Volume
5	60's & 70's Rock	61	ERA 66	Vintage 60's sound	Volume
		62	TROWER	70's spacey flanger/distortion sound, with long delay	Volume
		63	BUSTER	Classic smooth and loud overdrive	Volume
		64	WOW	Fat distortion with half-open Pedal Wah	Wah
		65	70/90	Vintage phaser sound	Volume
6	Rock'n'Roll & Blues	71	TELE	Slap back delay for rock'n'roll	Volume
		72	TURKEY	Dry overdrive sound for heavy comping and rhythm parts	Volume
		73	RHYFAT	Fat sound for rhythm parts	Volume
		74	*TUSH*	Heavy distortion for blues rhythm or slide parts	Volume
		75	LONDON	Clean, warm amp sound with slight reverb	Volume
7	Special Trick Effects	81	TRICK	Spacey phaser sound with long, rhythmic delay	Volume
		82	GHOSTS	Distant modulated sound with heavy, cavernous reverb	Volume
		83	HORROR	Heavy modulated phaser sound with Auto Wah and long rhythmic delay	Volume
		84	5 /11TH	Three-pitch distortion sound for solos	Reverb Mix
		85	OCTAVE	Clean, two-octave sound, with slight detuning for natural chorus	Volume
8	Line Sound	91	HARD-L	Distortion for hard rock	Volume
		92	LEAD-L	Bright distortion with long delay for lead parts	Volume
		93	META-L	Metal distortion with chorus for solos	Volume
		94	COMP-L	Funky sound for rhythm parts	Volume
		95	CLN-L	Clean sound with slight detuning	Volume
		01	BACK-L	Distortion for backing parts	Volume
		02	NECK-L	Blues sound (for use with the neck pickup)	Volume
		03	OLD-L	Old style rock'n'roll sound, slightly detuned with small room ambience	Distortion Drive
		04	PHAS-L	Distortion with classic phaser sound	Distortion Drive
		05	JAZZ-L	Modern jazz sound, with chorus and heavy reverb	Volume

MEMORY EFFECT PARAMETER LIST

■ 11: SO FAT

on=○/off=X	parameter	value
○	comp attack sense output	14 -26dB 170%
○	dist4 drive tone output	55% +8 39%
○	eq low mid high	+3dB -15dB +15dB +2dB
	input lo freq lo mid freq hi mid freq hi freq lo mid q hi mid q output	80% 1.2kHz 1.0kHz 1.2kHz 4.5kHz 5.0 5.0 100%
X	pitch left right mix	-15cent +10cent 10%
	L delay time L delay fb R delay time R delay fb dry	10ms 0% 10ms 0% 90%
○	rev time high mix	2.4s 0.6 20%
	type low dry	hall -3dB 100%
Utility Settings	connect	cmp,dst,eq,cho,rev
	group	—*1
	foot controller	cho-rev*2
	minimum volume	0
	auto volume	5
noise gate		4

■ 12: POPTOP

on=○/off=X	parameter	value
○	comp attack sense output	1 -22dB 122%
○	dist3 drive tone output	65% +3 60%
○	amp+eq type low high mix	combo 0dB +2dB 9%
	input lo freq lo mid freq hi freq output	100% 200Hz 2.8kHz 70%
○	cho1 speed brilliance depth	1.02Hz -3dB 14%
	mix amd dry	78% 0% 50%
○	dly+rev time dly mix rev mix	428ms 11% 10%
	dly fb db time db balance dly dry rev type rev time rev low rev high rev dry	14% 30ms 50% 89% hall 1.9s +1dB 0.3 90%
Utility Settings	connect	cmp,dst,eq,rev,cho
	group	—
	foot controller	cmp-dst
	minimum volume	5
	auto volume	5
noise gate		6

■ 13: CHINA

on=○/off=X	parameter	value
○	comp attack sense output	4 -19dB 164%
○	od drive tone output	57% +16 30%
○	eq low mid high	+7dB +7dB +1dB +5dB
	input lo freq lo mid freq hi mid freq hi freq lo mid q hi mid q output	80% 125Hz 630Hz 1.0kHz 3.2kHz 2.0 2.0 100%
X	cho1 speed brilliance depth	0.57Hz 0dB 80%
	mix amd dry	60% 0% 40%
○	dly+rev time dly mix rev mix	512ms 18% 11%
	dly fb db time db balance dly dry rev type rev time rev low rev high rev dry	20% 50ms 50% 81% hall 2.2s 0dB 0.5 100%
Utility Settings	connect	cmp,dst,eq,cho,rev
	group	—
	foot controller	rev mix
	minimum volume	0
	auto volume	5
noise gate		4

■ 14: TALKBX

on=○/off=X	parameter	value
○	comp attack sense output	1 -18dB 156%
○	od drive tone output	71% +4 45%
○	wah+eq type sense center freq range	touch slow 7 400Hz 14
	fb input lo lo freq hi hi freq output	0% 100% 0dB 125Hz 0dB 3.2kHz 130%
X	flanger speed fb depth	0.75Hz 18% 56%
	mix L time R time dry	60% 3.0ms 6.0ms 40%
○	dly+rev time dly mix rev mix	304ms 9% 11%
	dly fb db time db balance dly dry rev type rev time rev low rev high rev dry	25% 30ms 66% 91% hall 2.0s 0dB 0.5 89%
Utility Settings	connect	cmp,eq,dst,rev,cho
	group	—
	foot controller	cho-
	minimum volume	0
	auto volume	5
noise gate		3

■ 15: BIGBOT

on=○/off=X	parameter	value
○	comp attack sense output	14 -29dB 200%
○	dist4 drive tone output	66% +10 50%
○	eq low mid high	+3dB +5dB +3dB +4dB
	input lo freq lo mid freq hi mid freq hi freq lo mid q hi mid q output	100% 125Hz 800Hz 1.0kHz 3.2kHz 2.0 2.0 70%
○	pitch left right mix	-5cent +5cent 81%
	L delay time L delay fb R delay time R delay fb dry	10ms 11% 10ms 10% 75%
○	rev time high mix	1.7s 0.4 14%
	type low dry	hall +3dB 86%
Utility Settings	connect	cmp,dst,eq,cho,rev
	group	—
	foot controller	cho-rev
	minimum volume	0
	auto volume	5
noise gate		5

*1: The dash (—) means that there is no group assignment.

*2: Hyphens in this row indicate that the foot controller is used as a volume pedal and is placed at the hyphen position. For example, "cho-rev" indicate that the foot controller is placed between the Chorus and Reverb/Delay blocks.

SUPPLEMENTAL INFORMATION **MEMORY EFFECT PARAMETER LIST**

■ 21: HIWAY

on=0/off=X	parameter	value
X	comp attack sense output	14 -28dB 186%
o	dist1 drive tone output	26% +9 42%
o	amp+eq type low high mix	stack 0dB +5dB 25%
	input lo freq hi freq output	100% 125Hz 4.0kHz 74%
X	pitch left right mix	-5cent +10cent 32%
	L delay time L delay fb R delay time R delay fb dry	10ms 0% 10ms 0% 68%
o	dly+rev time dly mix rev mix	4ms 0% 4%
	dly fb db time db balance dly dry rev type rev time rev low rev high rev dry	20% 30ms 0% 100% hall 2.6s 0dB 0.1 96%
Utility Settings	connect	dst,eq,cmp,cho,rev
	group	—
	foot controller	dst drive
	minimum volume	0
	auto volume	5
noise gate		3

■ 22: ALIEN

on=0/off=X	parameter	value
o	comp attack sense output	8 -21dB 178%
o	dist1 drive tone output	77% +3 56%
o	amp+eq type low high mix	stack -5dB +3dB 21%
	input lo freq hi freq output	100% 200Hz 2.8kHz 100%
X	pitch left right mix	-10cent +10cent 65%
	L delay time L delay fb R delay time R delay fb dry	0.1ms 0% 0.1ms 0% 76%
o	dly+rev time dly mix rev mix	380ms 12% 5%
	dly fb db time db balance dly dry rev type rev time rev low rev high rev dry	14% 30ms 0% 88% hall 2.6s 0dB 0.2 95%
Utility Settings	connect	cmp,dst,eq,rev,cho
	group	—
	foot controller	eq-rev
	minimum volume	0
	auto volume	5
noise gate		8

■ 23: CROWS

on=0/off=X	parameter	value
o	comp attack sense output	1 -13dB 144%
o	dist4 drive tone output	27% +8 38%
o	amp+eq type low high mix	stack -4dB +4dB 25%
	input lo freq hi freq output	100% 280Hz 3.6kHz 100%
X	flanger speed fb depth	1.05Hz 0% 44%
	mix L time R time dry	60% 3.0ms 6.0ms 40%
o	rev time high mix	3.0s 0.3 12%
	type low dry	hall 0dB 88%
Utility Settings	connect	cmp,dst,eq,rev,cho
	group	—
	foot controller	cho-
	minimum volume	0
	auto volume	5
noise gate		4

■ 24: DRYBAK

on=0/off=X	parameter	value
o	comp attack sense output	3 -20dB 134%
o	dist3 drive tone output	43% +1 52%
o	eq low l mid h mid high	+6dB +6dB +7dB -5dB
	input lo freq lo mid freq hi mid freq hi freq lo mid q hi mid q output	81% 180Hz 630Hz 2.0kHz 5.0kHz 1.2 1.9 70%
o	pitch left right mix	-5cent +5cent 14%
	L delay time L delay fb R delay time R delay fb dry	0.1ms 80% 0.1ms 55% 86%
o	rev time high mix	1.8s 0.8 24%
	type low dry	hall 0dB 90%
Utility Settings	connect	cmp,dst,eq,cho,rev
	group	—
	foot controller	eq-cho
	minimum volume	0
	auto volume	5
noise gate		5

■ 25: SWIRL

on=0/off=X	parameter	value
o	comp attack sense output	7 -20dB 200%
X	dist4 drive tone output	61% 0 54%
o	amp+eq type low high mix	combo +3dB +6dB 100%
	input lo freq hi freq output	80% 280Hz 3.6kHz 60%
o	cho2 speed brilliance depth	0.66Hz -1dB 64%
	mix dry	75% 50%
o	dly+rev time dly mix rev mix	392ms 44% 43%
	dly fb db time db balance dly dry rev type rev time rev low rev high rev dry	25% 30ms 66% 90% hall 3.8s 0dB 0.8 100%
Utility Settings	connect	cmp,eq,dst,rev,cho
	group	—
	foot controller	cho-
	minimum volume	0
	auto volume	5
noise gate		6

■ 31: METAL

on=○/off=X	parameter	value
X	comp attack sense output	5 -33dB 126%
○	dist4 drive tone output	70% +15 35%
○	eq low l mid h mid high	+7dB +5dB -10dB +15dB
		input lo freq 450Hz lo mid freq 1.2kHz hi mid freq 500Hz hi freq 9.0kHz lo mid q 5.0 hi mid q 5.0 output 70%
○	pitch left right mix	-5cent 0dB 16%
		L delay time 0.1ms L delay fb 0% R delay time 0.1ms R delay fb 0% dry 86%
○	rev time high mix	2.0s 0.4 22%
		type low dry hall -3dB 100%
Utility Settings	connect	cmp,dst,eq,cho,rev
	group	—
	foot controller	cho-rev
	minimum volume	0
	auto volume	5
noise gate		5

■ 32: DRIVER

on=○/off=X	parameter	value
○	comp attack sense output	12 -25dB 26%
○	dist1 drive tone output	85% +3 37%
○	eq low l mid h mid high	+2dB +1dB +3dB +6dB
		input lo freq 160Hz lo mid freq 700Hz hi mid freq 2.2kHz hi freq 4.0kHz lo mid q 1.6 hi mid q 1.7 output 76%
X	cho1 speed brilliance depth	0.57Hz 0dB 80%
		mix amd dry 60% 0% 40%
○	rev time high mix	1.2s 0.5 33%
		type low dry room 0dB 100%
Utility Settings	connect	cmp,dst,eq,cho,rev
	group	cmp,dst
	foot controller	rev mix
	minimum volume	0
	auto volume	5
noise gate		3

■ 33: TOKYO

on=○/off=X	parameter	value
○	comp attack sense output	12 -21dB 148%
○	dist4 drive tone output	82% +4 34%
○	eq low l mid h mid high	-2dB +2dB +2dB +12dB
		input lo freq 140Hz lo mid freq 700Hz hi mid freq 1.2kHz hi freq 5.0kHz lo mid q 2.2 hi mid q 1.8 output 100%
X	flanger speed fb depth	2.04Hz 24% 44%
		mix L time 3.8ms R time 4.7ms dry 62%
○	rev time high mix	2.4s 0.7 30%
		type low dry room -1dB 100%
Utility Settings	connect	cmp,dst,eq,cho,rev
	group	—
	foot controller	cho-rev
	minimum volume	0
	auto volume	5
noise gate		5

■ 34: TOUCH

on=○/off=X	parameter	value
○	comp attack sense output	12 -18dB 100%
○	dist4 drive tone output	54% +1 50%
○	wah+eq type sense center freq range	touch slow 5 220Hz 22
		fb input 60% lo 29% lo freq +10dB hi 100Hz hi freq +10dB output 3.2kHz 200%
X	flanger speed fb depth	0.75Hz 14% 26%
		mix L time 60% R time 5.0ms dry 6.0ms 40%
○	rev time high mix	3.0s 0.7 16%
		type low dry hall 0dB 84%
Utility Settings	connect	cmp,eq,dist,cho,rev
	group	—
	foot controller	cho-rev
	minimum volume	0
	auto volume	5
noise gate		4

■ 35: WOMEN

on=○/off=X	parameter	value
○	comp attack sense output	11 -25dB 200%
X	dist4 drive tone output	64% -2 28%
○	amp+eq type low high mix	stack -1dB +15dB 0%
		input lo freq 90% lo 280Hz hi freq 3.6kHz output 64%
○	cho1 speed brilliance depth	0.60Hz +1dB 70%
		mix amd dry 78% 0% 50%
○	dly+rev time dly mix rev mix	416ms 45% 35%
		dly fb 25% db time 30ms db balance 49% dly dry 100% rev type hall rev time 3.8s rev low 0dB rev high 0.4 rev dry 100%
Utility Settings	connect	cmp,dst,eq,cho,rev
	group	—
	foot controller	rev-
	minimum volume	0
	auto volume	5
noise gate		6

SUPPLEMENTAL INFORMATION **MEMORY EFFECT PARAMETER LIST**

■ 41: JAZZY

on=0/off=X	parameter	value
o	comp attack sense output	14 -19dB 68%
X	od drive tone output	0% -8 100%
o	eq low l mid h mid high	+9dB +7dB +2dB 0dB
		input lo freq 80% 125Hz lo mid freq 630Hz hi mid freq 1.0kHz hi freq 3.2kHz lo mid q 2.0 hi mid q 2.0 output 130%
X	cho1 speed brilliance depth	0.48Hz +1dB 16%
		mix amd dry
		60% 0% 40%
o	rev time high mix	1.6s 0.2 22%
		type low dry
		hall +6dB 100%
Utility Settings	connect	cmp,dst,eq,cho,rev
	group	—
	foot controller	cho-rev
	minimum volume	0
	auto volume	5
noise gate		3

■ 42: FUNKY

on=0/off=X	parameter	value
o	comp attack sense output	14 -24dB 116%
X	dist1 drive tone output	60% +6 34%
o	eq low l mid h mid high	-2dB +4dB +9dB +9dB
		input lo freq 60% 180Hz lo mid freq 800Hz hi mid freq 1.8kHz hi freq 4.0kHz lo mid q 2.0 hi mid q 2.0 output 80%
o	phaser speed fb depth	0.18Hz 33% 43%
		mix dry
o	rev time high mix	1.2s 0.6 24%
		type low dry
Utility Settings	connect	cmp,dst,eq,cho,rev
	group	—
	foot controller	cho depth
	minimum volume	0
	auto volume	5
noise gate		0

■ 43: COMP+D

on=0/off=X	parameter	value
o	comp attack sense output	13 -42dB 144%
o	od drive tone output	55% +6 32%
o	eq low l mid h mid high	+10dB +6dB -6dB +7dB
		input lo freq 100% 125Hz lo mid freq 630Hz hi mid freq 1.0kHz hi freq 3.2kHz lo mid q 2.0 hi mid q 2.0 output 110%
X	cho1 speed brilliance depth	0.75Hz +3dB 9%
		mix amd dry
o	dly+rev time dly mix rev mix	512ms 13% 19%
		dly fb db time db balance dly dry rev type rev time rev low rev high rev dry
Utility Settings	connect	cmp,dst,eq,cho,rev
	group	amp,dst
	foot controller	cho-rev
	minimum volume	0
	auto volume	5
noise gate		3

■ 44: QUACK

on=0/off=X	parameter	value
o	comp attack sense output	6 -20dB 200%
X	dist4 drive tone output	70% 0 64%
o	wah+eq type sense center freq range	touch fast 5 1.0kHz 14
		fb input 0% lo +15dB lo freq 125Hz hi +6dB hi freq 3.6kHz output 132%
o	phaser speed fb depth	0.72Hz 17% 50%
		mix dry
X	dly+rev time dly mix rev mix	512ms 25% 19%
		dly fb db time db balance dly dry rev type rev time rev low rev high rev dry
Utility Settings	connect	cmp,dst,eq,rev,cho
	group	dst,rev
	foot controller	cho-
	minimum volume	0
	auto volume	5
noise gate		7

■ 45: SKANK

on=0/off=X	parameter	value
o	comp attack sense output	1 -16dB 200%
X	dist4 drive tone output	69% +1 65%
o	eq low l mid h mid high	-7dB +5dB +6dB +11dB
		input lo freq 50% 125Hz lo mid freq 630Hz hi mid freq 1.8kHz hi freq 3.2kHz lo mid q 2.0 hi mid q 2.0 output 40%
o	pitch left right mix	-10cent +5cent 55%
		L delay time L delay fb R delay time R delay fb dry
X	dly+rev time dly mix rev mix	512ms 23% 27%
		dly fb db time db balance dly dry rev type rev time rev low rev high rev dry
Utility Settings	connect	cmp,dst,eq,rev,cho
	group	dst,rev
	foot controller	cho-
	minimum volume	0
	auto volume	5
noise gate		7

■ 51: PROGRE

on=○/off=X	parameter	value
○	comp attack sense output	5 -29dB 134%
○	dist3 drive tone output	60% +10 41%
○	eq low l mid h mid high	+10dB +6dB -4dB +2dB
	input lo freq lo mid freq lo mid q hi freq hi mid q output	84% 125Hz 500Hz 1.1kHz 4.0kHz 1.7 2.0 60%
○	cho1 speed brilliance depth	0.03Hz +3dB 28%
	mix amd dry	90% 0% 60%
○	dly time fb mix	539ms 18% 25%
	db time db balance dry	50ms 58% 100%
Utility Settings	connect	cmp,dst,eq,cho,rev
	group	cho-rev
	foot controller	cho-
	minimum volume	0
	auto volume	5
noise gate		5

■ 52: OWNER

on=○/off=X	parameter	value
○	comp attack sense output	1 -14dB 156%
○	dist1 drive tone output	89% +2 40%
X	wah+eq type sense center freq range	touch fast 10 900Hz 7
	fb input lo lo freq hi hi freq output	0% 100% -15dB 280Hz -13dB 6.3kHz 200%
○	pitch left right mix	+700cent -500cent 32%
	L delay time L delay fb R delay time R delay fb dry	10ms 0% 10ms 0% 100%
○	dly+rev time dly mix rev mix	188ms 0% 28%
	dly fb db time db balance dly dry rev type rev time rev low rev high rev dry	25% 30ms 66% 100% hall 0.4s +6dB 0.1 100%
Utility Settings	connect	cmp,dst,eq,cho,rev
	group	—
	foot controller	rev-
	minimum volume	0
	auto volume	5
noise gate		8

■ 53: BREATH

on=○/off=X	parameter	value
○	comp attack sense output	4 -25dB 200%
X	od drive tone output	78% 0 39%
○	amp+eq type low high mix	stack +5dB +8dB 51%
	input lo freq hi freq output	80% 280Hz 3.2kHz 90%
○	cho1 speed brilliance depth	1.20Hz +1dB 29%
	mix amd dry	61% 0% 39%
○	dly+rev time dly mix rev mix	156ms 50% 22%
	dly fb db time db balance dly dry rev type rev time rev low rev high rev dry	10% 30ms 49% 75% hall 1.9s 0dB 1.0 100%
Utility Settings	connect	cmp,dst,eq,rev,cho
	group	—
	foot controller	cho-
	auto volume	5
noise gate		3

■ 54: MYSTRY

on=○/off=X	parameter	value
○	comp attack sense output	1 -37dB 200%
○	dist4 drive tone output	62% +2 70%
○	wah+eq type sense center freq range	touch fast 9 450Hz 12
	fb input lo lo freq hi hi freq output	0% 100% -13dB 125Hz +15dB 5.6kHz 120%
X	cho1 speed brilliance depth	0.39Hz -3dB 11%
	mix amd dry	61% 0% 39%
○	dly+rev time dly mix rev mix	496ms 20% 10%
	dly fb db time db balance dly dry rev type rev time rev low rev high rev dry	6% 30ms 0% 80% hall 1.9s +1dB 0.2 90%
Utility Settings	connect	cmp,dst,eq,rev,cho
	group	—
	foot controller	cho-
	minimum volume	0
	auto volume	5
noise gate		6

■ 55: CHURCH

on=○/off=X	parameter	value
○	comp attack sense output	10 -18dB 146%
X	od drive tone output	1% +9 95%
○	eq low l mid h mid high	+5dB +2dB +5dB +10dB
	input lo freq lo mid freq hi mid freq hi freq lo mid q output	86% 180Hz 900Hz 1.4kHz 4.5kHz 1.8 1.2 70%
○	pitch left right mix	+1200cent +1200cent 33%
	L delay time L delay fb R delay time R delay fb dry	2ms 76% 0.1ms 99% 67%
○	dly+rev time dly mix rev mix	348ms 39% 37%
	dly fb db time db balance dly dry rev type rev time rev low rev high rev dry	33% 36ms 45% 100% hall 3.0s -1dB 0.6 100%
Utility Settings	connect	cmp,dst,eq,cho,rev
	group	—
	foot controller	cho-rev
	minimum volume	0
	auto volume	5
noise gate		4

SUPPLEMENTAL INFORMATION **MEMORY EFFECT PARAMETER LIST**

■ 61: ERA 66

on=○/off=X	parameter	value
○	comp attack sense output	1 -22dB 200%
○	dist1 drive tone output	17% 0 33%
○	amp+eq type	stack -3dB +6dB 36%
	input	100%
	lo freq	280Hz
	hi freq	3.6kHz
	output	70%
X	phaser speed fb depth	5.10Hz 0% 16%
	mix dry	50% 50%
○	rev time high mix	0.8s 0.2 39%
	type low dry	hall 0dB 100%
Utility Settings	connect	cmp,dst,eq,rev,cho
	group	—
	foot controller	cho-
	minimum volume	0
	auto volume	5
noise gate		4

■ 62: TROWER

on=○/off=X	parameter	value
○	comp attack sense output	1 -19dB 200%
○	dist4 drive tone output	66% +7 47%
○	eq low l mid h mid high	-7dB +3dB +6dB +8dB
	input	90%
	lo freq	63Hz
	lo mid freq	630Hz
	hi mid freq	1.4kHz
	hi freq	3.2kHz
	lo mid q	2.0
	hi mid q	2.0
	output	50%
○	flanger speed fb depth	0.81Hz 40% 40%
	mix L time R time dry	60% 3.0ms 6.0ms 40%
○	dly+rev time dly mix rev mix	420ms 19% 19%
	dly fb db time db balance dly dry rev type rev time rev low rev high rev dry	25% 30ms 66% 81% dry hall 3.2s +2dB 0.3 100%
Utility Settings	connect	cmp,dst,eq,rev,cho
	group	—
	foot controller	cho-
	minimum volume	0
	auto volume	5
noise gate		5

■ 63: BUSTER

on=○/off=X	parameter	value
○	comp attack sense output	3 -15dB 158%
○	od drive tone output	37% +16 30%
○	eq low l mid h mid high	+8dB -1dB -3dB +6dB
	input	100%
	lo freq	125Hz
	lo mid freq	560Hz
	hi mid freq	2.0kHz
	hi freq	4.5kHz
	lo mid q	2.3
	hi mid q	2.0
	output	100%
X	flanger speed fb depth	6.18Hz 0% 9%
	mix L time R time dry	60% 3.0ms 6.0ms 40%
○	rev time high mix	0.3s 0.1 16%
	type low dry	plate 0dB 100%
Utility Settings	connect	cmp,eq,dst,rev,cho
	group	cmp,eq
	foot controller	cho-
	auto volume	5
noise gate		6

■ 64: WOW

on=○/off=X	parameter	value
X	comp attack sense output	1 -6dB 196%
○	dist4 drive tone output	71% +16 93%
○	wah+eq type	pedal no parameter
	center freq range	2.2kHz 28
	fb input lo lo freq hi hi freq output	22% 26% 0dB 1.2kHz 0dB 800Hz 140%
X	phaser speed fb depth	0.75Hz 72% 29%
	mix dry	60% 40%
○	rev time high mix	1.4s 0.3 24%
	type low dry	room 0dB 76%
Utility Settings	connect	cmp,eq,dst,rev,cho
	group	—
	foot controller	wah pedal
	minimum volume	0
	auto volume	5
noise gate		4

■ 65: 70/90

on=○/off=X	parameter	value
○	comp attack sense output	1 -20dB 134%
X	dist3 drive tone output	93% +7 27%
○	eq low l mid h mid high	+3dB +5dB +3dB +8dB
	input	50%
	lo freq	220Hz
	lo mid freq	800Hz
	hi mid freq	1.2kHz
	hi freq	3.6kHz
	lo mid q	1.1
	hi mid q	1.4
	output	100%
○	phaser speed fb depth	0.60Hz 48% 61%
	mix dry	61% 39%
○	rev time high mix	1.6s 0.8 14%
	type low dry	room 0dB 86%
Utility Settings	connect	cmp,dst,eq,cho,rev
	group	—
	foot controller	eq-cho
	minimum volume	0
	auto volume	5
noise gate		5

■ 71: TELE

on=○/off=X	parameter	value
○	comp attack sense output	3 -14dB 126%
X	dist3 drive tone output	36% +10 17%
○	eq low l mid h mid high	+6dB +4dB +4dB +10dB
	input lo freq lo mid freq hi mid freq hi freq lo mid q hi mid q output	60% 125Hz 630Hz 1.0kHz 3.2kHz 2.0 2.0 90%
X	pitch left right mix	-10cent +10cent 34%
	L delay time L delay fb R delay time R delay fb dry	10ms 0% 10ms 0% 66%
○	dly+rev time dly mix rev mix	164ms 20% 27%
	dly fb db time db balance dly dry rev type rev time rev low rev high rev dry	21% 30ms 0% 100% hall 0.9s 0dB 0.2 100%
Utility Settings	connect	cmp,dst,eq,cho,rev
	group	—
	foot controller	eq-cho
	minimum volume	0
	auto volume	5
noise gate		3

■ 72: TURKEY

on=○/off=X	parameter	value
○	comp attack sense output	1 -6dB 172%
○	od drive tone output	20% 0 50%
○	eq low l mid h mid high	+11dB +5dB -8dB +10dB
	input lo freq lo mid freq hi mid freq hi freq lo mid q hi mid q output	100% 125Hz 560Hz 2.0kHz 4.5kHz 2.3 2.0 80%
X	cho2 speed brilliance depth	5.34Hz +4dB 11%
	mix dry	45% 55%
○	dly+rev time dly mix rev mix	156ms 16% 0%
	dly fb db time db balance dly dry rev type rev time rev low rev high rev dry	0% 50ms 85% 100% hall 3.0s 0dB 0.5 100%
Utility Settings	connect	cmp,dst,eq,cho,rev
	group	—
	foot controller	rev-
	minimum volume	0
	auto volume	5
noise gate		6

■ 73: RHYFAT

on=○/off=X	parameter	value
○	comp attack sense output	11 -8dB 104%
○	dist2 drive tone output	14% +8 42%
○	amp+eq type low high mix	stack +7dB -2dB 63%
	input lo freq hi freq output	100% 125Hz 800Hz 80%
X	cho2 speed brilliance depth	1.14Hz -3dB 18%
	mix dry	60% 40%
○	rev time high mix	0.3s 1.0 7%
	type low dry	room 0dB 93%
Utility Settings	connect	dst,cmp,eq,cho,rev
	group	dst,cmp,eq
	foot controller	rev-
	minimum volume	0
	auto volume	5
noise gate		4

■ 74: *TUSH*

on=○/off=X	parameter	value
○	comp attack sense output	1 -26dB 122%
○	dist3 drive tone output	65% +1 50%
○	amp+eq type low high mix	combo +3dB +1dB 15%
	input lo freq hi freq output	100% 200Hz 2.8kHz 90%
X	cho1 speed brilliance depth	0.93Hz -3dB 41%
	mix amd dry	61% 0% 39%
○	dly+rev time dly mix rev mix	428ms 0% 5%
	dly fb db time db balance dly dry rev type rev time rev low rev high rev dry	14% 50ms 100% hall 2.4s 0dB 0.2 94%
Utility Settings	connect	cmp,dst,eq,rev,cho
	group	—
	foot controller	cho-
	minimum volume	0
	auto volume	5
noise gate		6

■ 75: LONDON

on=○/off=X	parameter	value
○	comp attack sense output	13 -26dB 178%
○	dist2 drive tone output	0% +16 50%
○	eq low l mid h mid high	0dB +1dB +2dB +5dB
	input lo freq lo mid freq hi mid freq hi freq lo mid q hi mid q output	100% 125Hz 125Hz 5.0kHz 1.0kHz 1.0 1.5 120%
X	cho2 speed brilliance depth	0.45Hz +6dB 37%
	mix dry	60% 40%
○	rev time high mix	1.6s 0.4 33%
	type low dry	hall 0dB 100%
Utility Settings	connect	cmp,eq,dst,cho,rev
	group	—
	foot controller	rev-
	minimum volume	0
	auto volume	5
noise gate		5

■ **81: TRICK**

on=0/off=X	parameter	value
o	comp attack sense output	3 -38dB 56%
o	dist1 drive tone output	82% +13 47%
o	eq low l mid h mid high input lo freq lo mid freq hi mid freq hi freq lo mid q hi mid q output	+3dB +2dB +9dB 0dB 100% 125Hz 560Hz 1.1kHz 2.5kHz 2.0 1.6 70%
o	phaser speed fb depth mix dry	0.12Hz 100% 50% 25% 75%
o	dly+rev time dly mix rev mix dly fb db time db balance dly dry rev type rev time rev low rev high rev dry	512ms 146% 30% 30% 50ms 50% 54% hall 3.0s 0dB 0.5 70%
Utility Settings	connect	cmp,dst,eq,cho,rev
	group	—
	foot controller	cho-rev
	minimum volume	0
	auto volume	5
noise gate		0

■ **82: GHOSTS**

on=0/off=X	parameter	value
o	comp attack sense output	14 -42dB 122%
o	dist4 drive tone output	87% +5 30%
o	wah+eq type sense center freq range fb input lo lo freq hi hi freq output	touch slow 3 400Hz 12 0% 60% +15dB 125Hz +14dB 3.6kHz 100%
o	cho1 speed brilliance depth mix amd dry	1.14Hz -3dB 37% 100% 0% 64%
o	dly+rev time dly mix rev mix dly fb db time db balance dly dry rev type rev time rev low rev high rev dry	392ms 100% 100% 15% 50ms 100% 35% hall 10.0s +5dB 0.5 0%
Utility Settings	connect	cmp,dst,eq,rev,cho
	group	—
	foot controller	cho-
	minimum volume	0
	auto volume	5
noise gate		7

■ **83: HORROR**

on=0/off=X	parameter	value
o	comp attack sense output	8 -25dB 200%
o	dist1 drive tone output	46% +2 20%
o	wah+eq type speed center freq range fb input lo lo freq hi hi freq output	auto 0.4Hz 355Hz 2 90% 100% +10dB 180Hz +3dB 3.2kHz 180%
o	phaser speed fb depth mix dry	0.78Hz 71% 24% 100% 43%
o	dly+rev time dly mix rev mix dly fb db time db balance dly dry rev type rev time rev low rev high rev dry	512ms 100% 10% 30% 50ms 50% 43% hall 1.6s +4dB 0.5 100%
Utility Settings	connect	cmp,eq,dst,cho,rev
	group	—
	foot controller	cho-rev
	minimum volume	0
	auto volume	5
noise gate		9

■ **84: 5/11TH**

on=0/off=X	parameter	value
o	comp attack sense output	8 -19dB 200%
o	dist4 drive tone output	56% +16 30%
o	eq low l mid h mid high input lo freq lo mid freq hi mid freq hi freq lo mid q hi mid q output	-2dB +8dB +4dB +10dB 23% 800Hz 3.2kHz 8.0kHz 2.2kHz 1.3 2.0 200%
o	pitch left right mix L delay time L delay fb R delay time R delay fb dry	-500cent +500cent 37% 0.1 ms 0% 0.1 ms 0% 63%
o	dly time fb mix db time db balance dry	623ms 15% 27% 50ms 50% 100%
Utility Settings	connect	cmp,eq,dst,rev,cho
	group	—
	foot controller	rev mix
	minimum volume	0
	auto volume	5
noise gate		6

■ **85: OCTAVE**

on=0/off=X	parameter	value
o	comp attack sense output	3 -24dB 184%
X	dist1 drive tone output	50% 0 20%
o	amp+eq type low high mix input lo freq hi freq output	combo +5dB +15dB 100% 60% 630Hz 4.5kHz 70%
o	pitch left right mix L delay time L delay fb R delay time R delay fb dry	-1200cent +5cent 77% 0.1ms 0% 10ms 0% 100%
o	dly+rev time dly mix rev mix dly fb db time db balance dly dry rev type rev time rev low rev high rev dry	240ms 25% 33% 30% 50ms 60% 100% plate 1.0s +6dB 1.0 100%
Utility Settings	connect	cmp,dst,eq,cho,rev
	group	—
	foot controller	cho-rev
	minimum volume	0
	auto volume	5
noise gate		5

■ 91: HARD-L

on=○/off=X	parameter	value
○	comp attack sense output	14 -17dB 40%
○	dist2 drive tone output	61% +2 66%
○	amp+eq type low high mix	combo -4dB +5dB 100%
	input lo freq hi freq output	100% 125Hz 4.0kHz 100%
X	flanger speed fb depth	1.23Hz 16% 25%
	mix L time R time dry	60% 3.0ms 6.0ms 40%
○	dly+rev time dly mix rev mix	4ms 0% 22%
	dly fb db time db balance dly dry rev type rev time rev low rev high rev dry	20% 30ms 0% 100% hall 2.6s 0dB 0.1 100%
Utility Settings	connect	dst,eq,cmp,cho,rev
	group	—
	foot controller	cmp-cho
	minimum volume	0
	auto volume	5
noise gate		3

■ 92: LEAD-L

on=○/off=X	parameter	value
○	comp attack sense output	7 -16dB 116%
○	dist3 drive tone output	77% 0 40%
○	amp+eq type low high mix	tube +5dB +8dB 100%
	input lo freq hi freq output	90% 140Hz 4.5kHz 50%
X	flanger speed fb depth	1.26Hz 29% 100%
	mix L time R time dry	54% 3.1ms 4.5ms 46%
○	dly+rev time dly mix rev mix	384ms 37% 22%
	dly fb db time db balance dly dry rev type rev time rev low rev high rev dry	38% 32ms 22% 100% hall 2.0s -1dB 0.8 100%
Utility Settings	connect	cmp,dst,eq,cho,rev
	group	—
	foot controller	cho-rev
	minimum volume	0
	auto volume	5
noise gate		5

■ 93: META-L

on=○/off=X	parameter	value
○	comp attack sense output	2 -25dB 98%
○	dist4 drive tone output	81% +3 36%
○	amp+eq type low high mix	combo -1dB +2dB 100%
	input lo freq hi freq output	80% 280Hz 3.6kHz 60%
○	cho1 speed brilliance depth	0.48Hz +1dB 49%
	mix amd dry	78% 0% 50%
○	dly+rev time dly mix rev mix	260ms 45% 23%
	dly fb db time db balance dly dry rev type rev time rev low rev high rev dry	25% 30ms 49% 100% hall 3.8s 0dB 0.4 100%
Utility Settings	connect	cmp,dst,eq,cho,rev
	group	—
	foot controller	rev-
	minimum volume	0
	auto volume	1
noise gate		6

■ 94: COMP-L

on=○/off=X	parameter	value
○	comp attack sense output	12 -31dB 168%
X	od drive tone output	4% +11 88%
○	eq low mid h mid high	+4dB +3dB +2dB +1.2dB
	input lo freq lo mid freq hi mid freq lo mid q hi mid q output	94% 180Hz 560Hz 1.0kHz 4.5kHz 1.4 1.7 100%
○	pitch left right mix	-10cent +5cent 47%
	L delay time L delay fb R delay time R delay fb dry	0.1ms 10% 0.1ms 0% 100%
○	rev time high mix	1.4s 0.7 19%
	type low dry	plate -1dB 100%
Utility Settings	connect	cmp,dst,eq,cho,rev
	group	—
	foot controller	eq-cho
	minimum volume	0
	auto volume	5
noise gate		5

■ 95: CLN -L

on=○/off=X	parameter	value
○	comp attack sense output	2 -17dB 120%
X	dist1 drive tone output	55% -2 17%
○	amp+eq type low high mix	combo -3dB +10dB 100%
	input lo freq hi freq output	70% 200Hz 2.8kHz 70%
○	cho1 speed brilliance depth	1.44Hz 0dB 47%
	mix amd dry	100% 0% 64%
○	dly+rev time dly mix rev mix	300ms 4% 19%
	dly fb db time db balance dly dry rev type rev time rev low rev high rev dry	14% 30ms 50% 96% hall 1.9s +1dB 0.3 100%
Utility Settings	connect	cmp,dst,eq,rev,cho
	group	—
	foot controller	cho-
	minimum volume	0
	auto volume	5
noise gate		7

SUPPLEMENTAL INFORMATION **MEMORY EFFECT PARAMETER LIST**

■ 01: BACK-L

on=0/off=X	parameter	value
o	comp attack sense output	11 -21dB 158%
o	dist3 drive tone output	78% +6 62%
o	amp+eq type low high mix	stack +6dB +4dB 85%
		input lo freq hi freq output 92% 200Hz 3.6kHz 48%
X	pitch left right mix	-10cent +15cent 55%
		L delay time L delay fb R delay time R delay fb dry 0.1ms 7% 0.1ms 0% 45%
o	rev time high mix	2.2s 0.6 18%
		type low dry hall +2dB 82%
Utility Settings	connect	cmp,dst,eq,cho,rev
	group	—
	foot controller	cho-rev
	minimum volume	0
	auto volume	5
noise gate		6

■ 02: NECK-L

on=0/off=X	parameter	value
o	comp attack sense output	5 -28dB 102%
o	dist1 drive tone output	36% +1 26%
o	amp+eq type low high mix	combo +7dB +15dB 100%
		input lo freq hi freq output 100% 200Hz 4.5kHz 56%
X	pitch left right mix	-10cent +5cent 37%
		L delay time L delay fb R delay time R delay fb dry 0.1ms 0% 0.1ms 0% 63%
o	dly+rev time dly mix rev mix	4ms 0% 10%
		dly fb db time db balance dly dry rev type rev time rev low rev high rev dry 14% 30ms 0% 100% room 1.0s -2dB 0.4 100%
Utility Settings	connect	cmp,dst,eq,rev,cho
	group	—
	foot controller	cho-
	minimum volume	0
	auto volume	5
noise gate		7

■ 03: OLD-L

on=0/off=X	parameter	value
X	comp attack sense output	3 -10dB 100%
o	od drive tone output	68% +5 35%
o	amp+eq type low high mix	combo +3dB +5dB 80%
		input lo freq hi freq output 80% 125Hz 3.2kHz 70%
o	pitch left right mix	+5cent +10cent 59%
		L delay time L delay fb R delay time R delay fb dry 0.1ms 0% 0.1ms 0% 100%
o	rev time high mix	0.8s 0.4 30%
		type low dry room +2dB 100%
Utility Settings	connect	cmp,dst,eq,cho,rev
	group	—
	foot controller	dst drive
	minimum volume	0
	auto volume	5
noise gate		5

■ 04: PHAS-L

on=0/off=X	parameter	value
o	comp attack sense output	14 -15dB 46%
o	od drive tone output	72% +4 65%
o	amp+eq type low high mix	combo +3dB +4dB 40%
		input lo freq hi freq output 100% 200Hz 4.0kHz 88%
o	phaser speed fb depth	0.66Hz 0% 25%
		mix dry 90% 90%
o	dly+rev time dly mix rev mix	512ms 5% 12%
		dly fb db time db balance dly dry rev type rev time rev low rev high rev dry 21% 30ms 0% 95% hall 2.0s 0dB 0.2 100%
Utility Settings	connect	dst,eq,cmp,cho,rev
	group	cmp,dst,eq
	foot controller	dst drive
	minimum volume	0
	auto volume	5
noise gate		5

■ 05: JAZZ-L

on=0/off=X	parameter	value
o	comp attack sense output	1 -20dB 200%
X	dist4 drive tone output	22% -4 42%
o	eq low l mid h mid high	+1dB +2dB +8dB +9dB
		input lo freq lo mid freq hi mid freq hi freq lo mid q output 60% 70Hz 630Hz 1.0kHz 3.2kHz 2.0 2.0 50%
o	cho2 speed brilliance depth	0.42Hz -1dB 30%
		mix dry 75% 50%
o	dly+rev time dly mix rev mix	408ms 11% 49%
		dly fb db time db balance dly dry rev type rev time rev low rev high rev dry 14% 30ms 0% 100% hall 2.8s -3dB 0.8 100%
Utility Settings	connect	cmp,dst,eq,rev,cho
	group	—
	foot controller	cho-
	minimum volume	0
	auto volume	5
noise gate		7

MANUAL EFFECT FACTORY SET PARAMETER CHART

on=○/off=×	Effect Type	Parameter	Value
×	Comp	Attack	*
		Sense Output	
×	Dist 1~4, Od	Drive	*
		Tone Output	
×	Equalizer	Low Gain	*
		Low Middle Gain	
		High Middle Gain	
		High Gain	
		Input	100%
		Low Frequency	140Hz
		Low Mid Frequency	700Hz
		High Mid Frequency	1.2kHz
		High Frequency	3.6kHz
		Low Mid Q	2.0
	High Mid Q	2.0	
	Output	100%	
Wah+EQ	Type	Sense or Speed	*
		Center Frequency	
	Range		
	Feedback	0%	
Amp Simulator+EQ	Type	Low Gain	*
		High Gain	
	Mix		
	Input	100%	
	Low Frequency	200%	
	High Frequency	3.6kHz	
Output	100%		
×	Chorus1	Speed	*
		Brilliance	
		Depth	
		Mix	75%
	AMD	0%	
	Dry	50%	
	Chorus2	Speed	*
		Brilliance	
		Depth	
		Mix	75%
	Dry	50%	
Pitch Shifter	Pitch L	Pitch R	*
		Mix	
	L Delay Time	L Delay FB	0.1ms
		R Delay Time	0.1ms
	R Delay FB	0%	
	Dry	100%	

on=○/off=×	Effect Type	Parameter	Value
	Flanger	Speed	*
		Feedback	
		Depth	
		Mix	75%
		L Delay Time	3ms
		R Delay Time	6ms
	Dry	50%	
	Phaser	Speed	*
		Feedback	
		Depth	
		Mix	75%
	Dry	50%	
×	Reverb	Time	*
		High	
		Mix	
		Reverb Type	Hall
		Low Gain	0dB
		Dry	100%
	Delay (Tap)	Time	*
		Feedback	
		Mix	
		Doubling Time	50ms
	Doubling Balance	55%	
	Dry	100%	
Delay+Reverb	Delay Time	Delay Mix	*
		Reverb Mix	
	Delay Feedback	Doubling Time	25%
		Doubling/Dry Balance	55%
	Delay Dry	Reverb Type	100%
		Reverb Time	Hall
		Reverb Low Gain	2.6sec
Reverb High	Reverb High	0dB	
	Reverb High	0.5	
	Reverb Dry	100%	
Utility Settings	Connect	cmp, dst, eq, cho, rev	
	Group	—	
	Foot Controller	cho-rev	
	Minimum Volume	0	
	Auto Volume	5	
Noise Gate	3		

Factory Set Values for Other Functions

Foot Switch	ASSIGNABLE Type switch
Pitch	440Hz
Chord	C, Am, F, G
Control Change	91~95

* Main parameter settings depend on the parameter knob position.

Note: The sub parameter values here are default settings that are automatically called up in the Memory Edit mode when the effect type is changed. Main parameters, however, remain the same (or proportionally the same, if different ranges exist for different types).

PRESET PATTERN LIST

Note: The Drums part data is transmitted over MIDI channel 5. For a list of the specific drum and percussion sounds used in the Drums part, see page 146.

Category	Pattern No.	Name	Type	Tempo	Meas	Style	Instrument		
							Accomp1 (MIDI Ch. 2)	Accomp2 (MIDI Ch. 3)	Bass (MIDI Ch. 4)
Rock/Pop	1~4	RP1	8-beat	120	2	Popular	Piano	Muted Guitar	Fingered Bass
	5~8	RP2	8-beat	146	2	Soul pop	Muted Guitar	Organ 2	Fingered Bass
	9~12	RP3	8-beat	120	2	Hard rock pop	Strings Ensemble	Distortion Guitar	Fingered Bass
	13~16	RP4	8-beat	200	2	Fast pop	Piano	Electric Guitar	Fingered Bass
	17~20	RP5	8-beat	116	2	Slow Euro	Piano	Muted Guitar	Fingered Bass
	21~24	RP6	16-beat	130	2	16-beat pop	Piano	Electric Guitar	Fingered Bass
	25~28	RP7	8-beat shuffle	150	2	Shuffle rock pop	Piano	Distortion Guitar	Fingered Bass
	29~32	RP8	8-beat shuffle	110	2	Old shuffle	Folk Guitar	Electric Guitar	Fingered Bass
	33~36	RP9	16-beat shuffle	92	2	Dance pop	Piano	Clavi	Fingered Bass
Hard Rock	37~40	HR1	8-beat	136	4	Fast rock boogie	Piano	Distortion Guitar	Picked Bass
	41~44	HR2	8-beat	118	2	Slow rock boogie	Piano	Distortion Guitar	Fingered Bass
	45~48	HR3	8-beat	100	2	Slow modern	Distortion Guitar	Synth Brass	Fingered Bass
	49~52	HR4	8-beat	160	2	Hard rock	Distortion Guitar	Distortion Guitar	Fingered Bass
	53~56	HR5	8-beat	118	4	Hard psychedelic	Electric Guitar	Distortion Guitar	Fingered Bass
	57~60	HR6	16-beat	100	2	Heavy metal	Distortion Guitar	Distortion Guitar	Fingered Bass
	61~64	HR7	16-beat	160	4	Fast 16-beat	Distortion Guitar	Synth Brass	Fingered Bass
	65~68	HR8	8-beat shuffle	140	2	Mid tempo shuffle	Distortion Guitar	Clavi	Fingered Bass
	69~72	HR9	8-beat shuffle	194	2	Fast shuffle	Electric Guitar	Distortion Guitar	Fingered Bass
Rock'n'Roll	73~76	RR1	8-beat	158	2	50s rock'n'roll	Muted Guitar	Organ 2	Fingered Bass
	77~80	RR2	8-beat shuffle	155	4	Boogie woogie	Electric Guitar	Piano	Fingered Bass
	81~84	RR3	8-beat shuffle	126	2	Modern	Synth Brass	Muted Guitar	Synth Bass 1
	85~88	RR4	8-beat shuffle	146	2	with brass section	Piano	Brass Ensemble	Fingered Bass
Ballad	89~92	BA1	8-beat	80	4	Popular	Piano	Strings Ensemble	Fingered Bass
	93~96	BA2	8-beat	80	2	Basic	Electric Piano 2	Strings Ensemble	Fingered Bass
	97~100	BA3	16-beat	90	4	Basic funk	Piano	Electric Piano 1	Slap Bass
	101~104	BA4	16-beat	84	2	Funk	Clavi	Muted Guitar	Slap Bass
	105~108	BA5	8-beat shuffle	66	2	8-beat shuffle	Folk Guitar	Piano	Fingered Bass
	109~112	BA6	16-beat shuffle	86	4	Euro shuffle	Piano	Muted Guitar	Fingered Bass
	113~116	BA7	16-beat shuffle	96	2	Popular shuffle	Strings Ensemble	Folk Guitar	Fingered Bass
	117~120	BA8	16-beat shuffle	88	4	Funk shuffle	Muted Guitar	Electric Piano 1	Synth Bass 1
Funk	125~128	FU1	16-beat	128	4	Late '70s	Organ 2	Clavi	Fingered Bass
	129~132	FU2	16-beat	108	4	Early '70s	Organ 2	Clavi	Fingered Bass
	133~136	FU3	16-beat	100	2	Modern	Clavi	Electric Piano 1	Slap Bass
Dance	137~140	DA1	16-beat	120	4	Rock dance	Synth Comp	Electric Guitar	Synth Bass 2
	141~144	DA2	16-beat	120	4	Disco	Electric Piano 1	Strings Ensemble	Fingered Bass
	145~148	DA3	16-beat	120	2	Euro house	Piano	Synth Bass 2	Synth Lead
	149~152	DA4	16-beat shuffle	90	2	Slow Euro	Piano	Muted Guitar	Fingered Bass

Preset Pattern List (cont.)

Category	Pattern No.	Name	Type	Tempo	Meas	Style	Instrument		
							Accomp1 (MIDI Ch. 2)	Accomp2 (MIDI Ch. 3)	Bass (MIDI Ch. 4)
Rhythm & Blues	153~156	RB1	8-beat	126	2	with organ	Organ 2	Muted Guitar	Fingered Bass
	157~160	RB2	8-beat	120	2	Basic	Electric Piano 1	Electric Guitar	Slap Bass
	161~164	RB3	8-beat	192	4	Old	Piano	Electric Guitar	Fingered Bass
	165~168	RB4	8-beat	122	2	Slow soul	Electric Piano 1	Muted Guitar	Slap Bass
	169~172	RB5	16-beat	140	2	Soul with brass	Piano	Brass Ensemble	Fingered Bass
	173~176	RB6	8-beat shuffle	132	4	Blues	Organ 1	Distortion Guitar	Fingered Bass
	177~180	RB7	8-beat shuffle	180	2	Detroit soul	Electric Piano 1	Electric Guitar	Slap Bass
	181~184	RB8	12-beat	93	2	Blues with triplet feel	Piano	Electric Guitar	Fingered Bass
Jazz Contemporary	185~188	JC1	16-beat	108	2	Pop fusion	Electric Piano 2	Fingered Bass	Fingered Bass
	189~192	JC2	16-beat	104	2	Latin fusion	Piano	Marimba	Fingered Bass
	193~196	JC3	16-beat	100	2	West coast	Electric Piano 1	Vibes	Fingered Bass
Jazz Traditional	197~200	JT1	8-beat shuffle	250	3	Bebop	—	Piano	Fingered Bass
	201~204	JT2	8-beat shuffle	80	3	Jazz ballad	Vibes	Piano	Fingered Bass
	205~208	JT3	8-beat shuffle	126	3	Swing	Muted Guitar	Piano	Fingered Bass
	209~212	JT4	3/4 time	200	4	Jazz waltz	—	Piano	Fingered Bass
Latin	213~216	LA1	8-beat	146	2	Bossa nova	Folk Guitar	Electric Piano 1	Fingered Bass
	217~220	LA2	8-beat	126	2	Rock cha cha	Organ 1	Organ 2	Fingered Bass
	221~224	LA3	16-beat	116	4	Salsa	Folk Guitar	Brass Ensemble	Fingered Bass
Reggae	225~228	RE1	16-beat	90	4	Modern with strings	Piano	Strings Ensemble	Fingered Bass
	229~232	RE2	16-beat shuffle	78	4	Basic	Organ 1	Piano	Fingered Bass
World	233~236	WO1	2-beat	128	2	Polka	Folk Guitar	Brass Ensemble	Fingered Bass
	237~240	WO2	3/4 time	104	4	New age ethnic	Synth Bell	Marimba	Fingered Bass
For Retrigger*	241	RT8	8-beat	116	2		Piano	—	Fingered Bass
	242	RT8S	8-beat shuffle	146	2		Piano	—	Fingered Bass
	243	RT16	16-beat	100	2		Electric Piano 1	—	Fingered Bass
	244	RT16S	16-beat shuffle	86	4		Piano	—	Fingered Bass
	245	END	—	100	1		the currently sounding voice(s)		
	246	METRO	4/4 time	120	1				
	247	MET 3	3/4 time	100	1				
248	BLANK		100	1					

* The Retrigger function lets you record rhythmic “hits” in which some of the Backing parts sound altogether, to create accents in a song. Special Retrigger patterns (nos. 241–244) are provided for this purpose, letting you enter the retrigger “hits” by entering a chord event at the desired 16th note position. However, the Retrigger function can be used with any of the other patterns by entering a chord event while a note of the pattern data is playing (in other words, not during a rest).

DRUM AND PERCUSSION SOUNDS USED FOR DRUMS PARTS

This chart lists the instrument sounds used for the Drums parts in the Backing section, along with their assigned note values (given here both in conventional form and MIDI note number). Drums part data is transmitted over MIDI channel 5.

Note name	MIDI Note	Instrument
C1	36	Bass drum 1
C#1		37 Bass drum 2
D1	38	Snare drum 1
D#1		39 Snare drum 2
E1	40	Tom low
F1	41	Tom mid
F#1		42 Tom high
G1	43	Handclaps
G#1		44 Crash cymbal
A	45	Rimshot
A#1		46 Ride cymbal
B1	47	Closed hi-hat
C2	48	Open hi-hat
C3	60	Bass drum 3
C#3		61 Cowbell
D3	62	Snare drum 3
D#3		63 Snare drum 4
E3	64	Conga low
F3	65	Conga high
F#3		66 Conga muted
G3	67	Agogo low
G#3		68 Agogo high
A3	69	Timbale low
A#3		70 Timbale high
B3	71	Hi-hat 2
C4	72	Shaker

FACTORY SET SONG LIST

Song number	Song name	Beat	Tempo	Length (in measures)	Description
1	BOOGIE	4/4	150	54	Two-part medley: old-style boogie and hard rock version
2	FUNK	4/4	119	20	Funk motif
3	REGGAE	4/4	78	16	Reggae motif
4	BALLAD	4/4	72	16	Slow ballad motif
5	BOSSA	4/4	131	16	Bossa nova motif
6	R * B	4/4	136	24	Funky R&B motif
7	4MEAS	4/4	120	60	Special four-measure chord progressions/patterns for practice purposes
8					No recorded data (left blank for user recording)

All songs also have their own effect program setting (or settings) specially chosen to match the style, allowing you to play your guitar along with the song.

Song #7 features several four-measure phrases in different styles, each preceded by a one-bar metronome introduction. These phrases are intended especially for practice purposes. Each phrase has been recorded with a different chord progression, and the phrases increase in difficulty, with easy progressions in the first phrases and more difficult ones in the latter. Use the Repeat A-B function to repeat a single phrase indefinitely while you practice a guitar part over it. These phrases (as well as the other six songs) also should provide helpful hints as to how to use the Backing section of the GW50 in your own compositions.

MIDI SPECIFICATIONS

EFFECT AND BACKING MODES

■ Data Reception/Transmission

(Received Data)

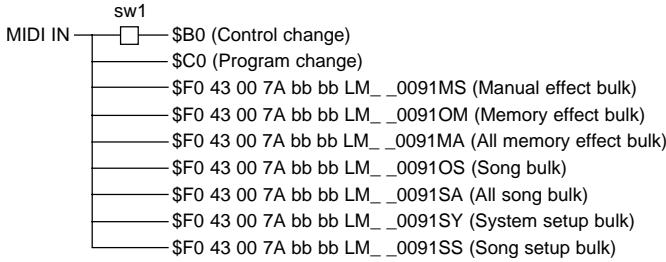

sw1: Selects control numbers 91~95 or 116~120 for Effect on/off.

(Transmitted Data)

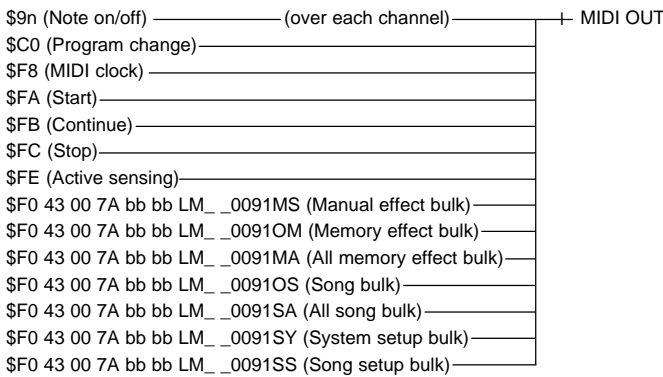

■ Transmitted Channel Messages

Note On/Off

Note on/off messages are transmitted only when Backing patterns (or songs) are played back or when notes are played by using the Position Controls.

- Transmitted note range : 0~127
- Transmitted velocity range : 1~127
- Note off : Velocity 0

Control Change

Control change messages are not transmitted.

Program Change

Program change messages are transmitted when an effect program is selected in the Memory mode and when effect

program change events are played back in Song play. (However, the GW50's internal effect program does not change if the Job or Edit mode of the Effect section is currently selected.) The transmit channel is fixed at 1.

The program change number assignments are shown in the following chart:

Memory number	Program Change Data	
	\$C0 xx	
11~15	00~04	
21~25	05~09	
31~35	10~14	
41~45	15~19	
51~55	20~24	
61~65	25~29	
71~75	30~34	
81~85	35~39	
91~95	40~44	
01~05	45~49	

■ Received Channel Messages

Note On/Off

Note on/off messages are not received.

Control Change

Switch individual effect blocks on/off by using the control change numbers shown below.

The corresponding effect is alternately switched on and off each time an appropriate control change message is received. The receive channel is fixed at 1, and the control value is fixed at 0.

	Control Change Data	
	\$B0 xxx \$0	
Compressor on/off	92	(116)
Distortion on/off	94	(117)
Equalizer Section on/off	95	(118)
Chorus Section on/off	93	(119)
Reverb Section on/off	91	(120)

One of two different sets of control change numbers can be used: 91~95, or 116~120. The set of numbers used is part of the system setup data, and the setting is maintained even when the power is turned off.

The default factory setting is 91~95.

Program Change

Program change messages can be received only when the Effect section is in Memory mode and Manual mode. The program change number correspondence for receiving is the same as that for transmission. The MIDI receive channel is also set to 1.

System Realtime Messages

Status bytes: F8, FA, FB, FC

These are transmitted, but not received.

Status bytes: F9, FD, FF

These are neither transmitted nor received.

Status byte: FE (Active sensing)

This is transmitted, but not received.

BULK DUMP

Reception of bulk dump data is possible in all but the following conditions:

- * Demo mode
- * Tuner mode
- * MIDI Bulk Transmission mode
- * While Backing section parts are being played
- * During recording and editing in the Backing section
- * During editing of effects

Transmission of bulk dump data is executed in the MIDI Bulk Transmission mode; when "ALL" is selected, data is transmitted in the following order: Manual effect, all Memory effect programs, all songs and System setup.

When data is divided into several blocks before transmission, there is an interval of 100 ms between transmission of each block.

Manual Effect Data Bulk Dump

◆ Refer to "EFFECT PARAMETER CHART" on page 130 for details on the data contents.

The main parameter settings (made with the parameter knobs) are not transmitted or received.

Current Memory Effect Program Data Bulk Dump

◆ Refer to "EFFECT PARAMETER CHART" on page 130 for details on the data contents.

All Memory Effect Program Data Bulk Dump

When transmitting all Memory effect program data, transmission starts from Memory bank 1 and ends with bank 0.

The data is divided into ten blocks before transmission (one memory bank equalling one block), with data from the byte count to check sum treated as a single block.

Current Song Data Bulk Dump

Song data is output by converting one byte into two bytes of ASCII.

When the amount of data is beyond 512 bytes, the data is divided into several blocks before transmission, with data from the byte count to check sum treated as a single block.

Song setup bulk data is always transmitted after transmission of the bulk data of a single song.

All Song Data Bulk Dump

Song setup data for song 1~8 is transmitted in the first block, and the actual song data is transmitted starting with the second block.

Song data is output by converting one byte into two bytes of ASCII.

When the amount of song data is beyond 512 bytes, the data is divided into several blocks before transmission, with data from the byte count to check sum treated as a single block.

Song Setup Data Bulk Dump

Song setup bulk data is always transmitted after transmission of the bulk data of a single song.

◆ Refer to Chart 1 below for details on the data format.

System Setup Data Bulk Dump

◆ Refer to Chart 2 below for details on the data format.

Chart 1

	DATA NAME	DATA RANGE
0	set a measure	0~298
1		
2	set b measure	0~298
3		
4	a-b repeat	0,1(repeat)
5	tempo	30~250
6	song name	(Space) ,0~9,A~Z,* ,+,-,/
7		
11		

Chart 2

	DATA NAME	DATA RANGE
0	effect mode	0(manual), 1(memory)
1	backing mode	0(pattern), 1(song)
2	effect memory bank	0~9
3	effect memory number	0~4
4	pattern number	0~247
5	song number	0~7
6	tuner pitch	0~5
7	assignable foot type	0~4
8	recall chord	0~255
9		
19		
20	external foot assign	16~255
21	control change select switch	0(91~95),1(116~120)

Function ...	Transmitted	Recognized	Remarks
Basic Default	: 1	: 1	
Channel Changed	: x	: x	
Mode Default	: x	: x	
Mode Messages altered	: x : *****	: x : x	
Note	: x	: x	
Number : True voice	: *****	: x	
Velocity Note ON	: x	: x	
Note OFF	: x	: x	
After Key's	: x	: x	
Touch Ch's	: x	: x	
Pitch Bender	: x	: x	
91-95	: x	: o	: *1
116-120	: x	: o	: *1
Control Change	:	:	:
Prog Change : True #	: o 0-49 : *2	: o 0-49 : *2	: *3
System Exclusive	: o	: o	: *4
common : Song Pos. : Song Sel. : Tune	:	:	See the Backing section.
System :Clock Real Time :Commands	:	:	:
Aux :Local ON/OFF	: x	: x	:
:All Notes OFF	: x	: x	:
Mes- :Active Sense	: x	: x	:
sages:Reset	: x	: x	:
Note *1	Select 91-95 or 116-120 by control change select switch.		:
*2	Prog True #		:
	0-4 = 11-15, 5-9 = 21-25 ... 40-44 = 91-95, 45-49 = 01-05		:
*3	In Memory and Manual modes.		:
*4	Memory effect and Manual settings.		:
Mode 1 : OMNI ON, POLY	Mode 2 : OMNI ON, MONO	o : Yes	
Mode 3 : OMNI OFF, POLY	Mode 4 : OMNI OFF, MONO	x : No	

Function ...	Transmitted	Recognized	Remarks
:Basic Default	: 1-5	: 1	
:Channel Changed	: x	: x	
: Mode Default	: x	: x	
: Mode Messages altered	: x : *****	: x : x	
:Note Number : True voice	: 0-127 : *****	: x	
:Velocity Note ON	: o 9nH, v=1-127	: x	
: Velocity Note OFF	: x 9nH, v=0	: x	
:After Touch Key's Ch's	: x : x	: x : x	
:Pitch Bender	: x	: x	
: Control Change	: 91-95 : x : 116-120 : x	: o : o	: *1 : *1
: Prog Change : True #	: o 0-49 : *2	: o 0-49 : *2	: *3
:System Exclusive	: o	: o	: *4
: common : Song Pos. : Song Sel. : Tune	: x : x : x	: x : x : x	
:System Real Time :Clock :Commands	: o : o	: x : x	
:Aux :Local ON/OFF : All Notes OFF	: x : x	: x : x	
:Mes- :Active Sense : sages:Reset	: o : x	: x : x	
:Note *1 Select 91-95 or 116-120 by control change select switch.			
: *2 Prog True #			
: 0-4 = 11-15, 5-9 = 21-25 ... 40-44 = 91-95, 45-49 = 01-05			
: *3 In Memory and Manual modes.			
: *4 Song data, etc.			

Mode 1 : OMNI ON, POLY Mode 2 : OMNI ON, MONO o : Yes
 Mode 3 : OMNI OFF, POLY Mode 4 : OMNI OFF, MONO x : No

CHART OF CHORD FINGERINGS FOR GUITAR

This chart shows the fingerings for the 25 different chord types in the key of C. Three different positions are given for each chord. An “x” indicates that the corresponding string is not part of the chord and should not be played. An “o” indicates that the corresponding string is an open string and is part of the chord; an “(o)” indicates that the open string is optional. The stars (“☆”) on the right side of the chart indicate the strings corresponding to the root note. Use of the thumb is indicated by the letter “T,” and the number at the bottom of each diagram indicates the position on the fretboard.

MAJOR TRIAD

C C G G C

MINOR

C_m C F G C

SEVENTH

C₇ C G F G C

MINOR SEVENTH

C_{m7} C F G B C

MAJOR SEVENTH

C_{M7} B G F G C

MAJOR ADDED NINTH

C_{Madd9} B G G G C

MINOR ADDED NINTH

C_{m add9} B G G G C

NINTH

C₉ D B G G C

MINOR NINTH

C_{m9} D B G G C

MAJOR NINTH

C_{M9} D B G G C

SUSPENDED FOURTH

C_{sus4} C F G C

MINOR SIXTH

C_{m6} A G F G C

SEVENTH SHARP NINTH

C₇₊₉ D# B G G C

MINOR SEVENTH ELEVENTH

C_{m7-11} F C F G C

SEVENTH FLATTED NINTH

C₇₋₉ D# B G G C

SEVENTH SUSPENDED FOURTH

C_{7sus4} C F G C

MINOR MAJOR SEVENTH

C_{mM7} C F G B C

SEVENTH SHARP ELEVENTH

C₇₊₁₁ F# C F G C

SIXTH

C₆ A G G C

SEVENTH FLATTED THIRTEENTH

C₇₋₁₃ A- B G G C

DIMINISHED

C_{dim} F# D# C

MINOR SEVENTH FLATTED FIFTH

C_{m7-5} C F G B C

THIRTEENTH

C₁₃ A B G G C

SIXTH NINTH

C₆₍₉₎ D A G G C

AUGMENTED

C_{aug} C F G C

USE OF ADVANCED RECORDING TECHNIQUES – FACTORY SET SONG 1

The demo songs take full advantage of the sophisticated accompaniment and recording features of the GW50. We recommend that you listen closely to the songs and “browse” through the recorded data to pick up helpful pointers on how you can effectively use these features in your own recordings.

To get you started, some of details of the recording of Song 1 are shown below, illustrating in particular the use of the Mute, bass note and Retrigger functions. Try some of these techniques in your own recordings, and you’ll soon see how powerful the accompaniment and recording features of the GW50 can be.

Using Mute to Build Up Instrumental Layers

In this passage from the beginning of Song 1, the instrument sounds are built up in layers, with only the drums playing in measure 1, the bass coming in at measure 2, and finally the accompaniment starting at the top of the second chorus at measure 13.

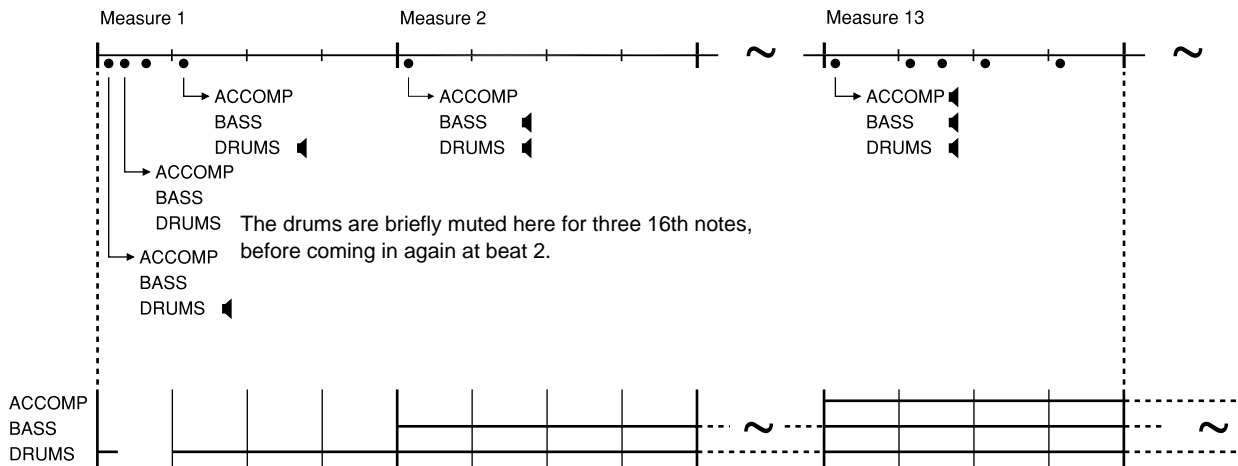

Using Mute to Create Custom Accompaniment

Although the accompaniment has been designed to best suit the various patterns of the GW50, you may want to change the accompaniment slightly to fit your music. Since the mute status of the accompaniment, bass or drums can be changed every 16th note, you have a lot of flexibility in customizing the pre-programmed accompaniment. In this example from measure 22, the accompaniment is muted for one 16th note, effectively cutting off the brass sound from beat 2.

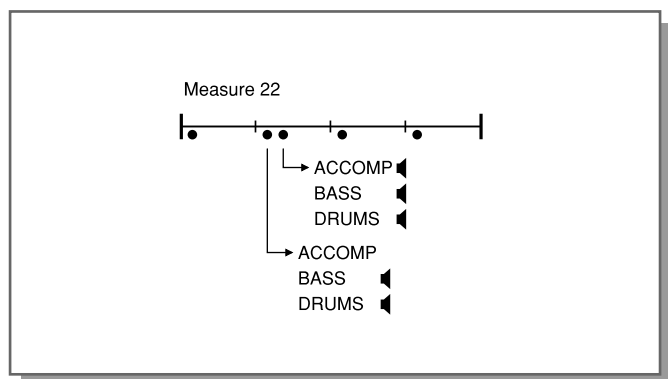

Using Mute to Interrupt Sustained Sounds

In a variation of the above technique, you can also use mute to break up sustained sounds in the accompaniment, such as strings or a held bass note. However, this cannot be done by mute events alone; even with an accompaniment mute event following a chord event, the sustained sound continues to be heard. To get around this, insert a “dummy” chord event AT or AFTER the mute event. In this way, the sustained sound will be muted from the point of the “dummy” event.

As shown in the example below from measure 53, the mute event At or is entered at the second 16th note and the “dummy” chord event (A7+9/F^s) is entered after it, at the third 16th note. As a result, the sustained accompaniment note is muted from the third 16th note. In this example, however, the mute event can be entered together with the “dummy” chord event at the third 16th note and the result would still be the same.

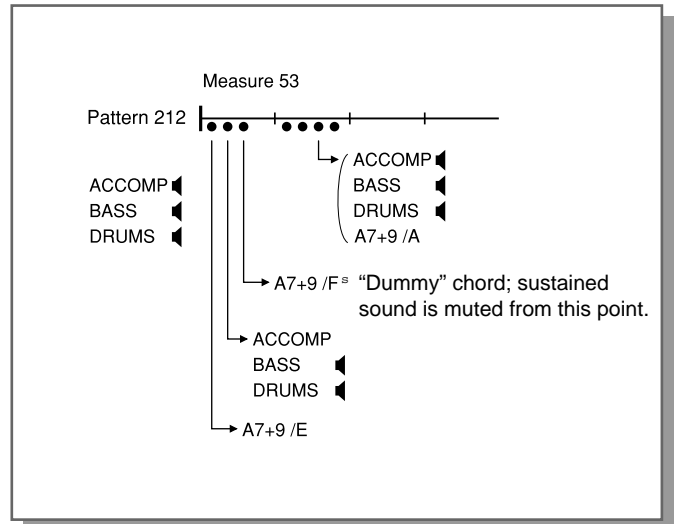

This effectively interrupts the normally held accompaniment sound by two 8th note rests. The sustained sound is brought back in again by un-muting the accompaniment at the third 16th note in beat 2.

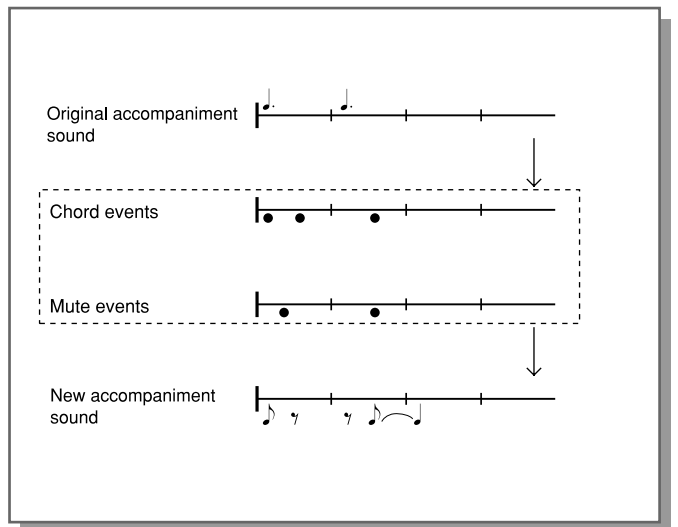

Creating a Custom Bass Line

Since the GW50 allows you to enter different bass notes at each 16th note in a measure, you can create your own custom bass line. In this example from measures 4 and 5, a custom bass line is played under a constant A7 chord.

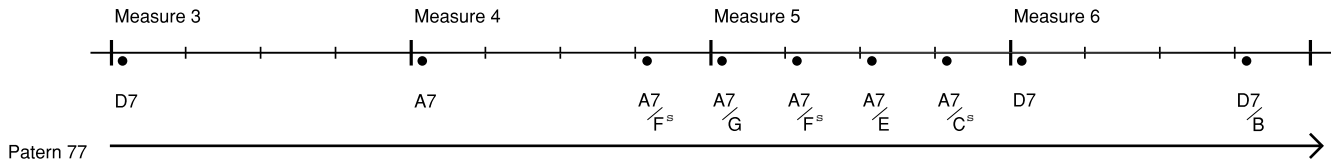

Using Retrigger for Rhythmic Accents

With Retrigger, you can record rhythmic “hits” or accents at any 16th note point of a measure. Although special Retrigger patterns (nos. 241 - 244) are provided for this, you can also enter retrigger accents by simply putting in additional chord events over the pattern currently playing. This would come in handy, for example, if you want to put accents in just the first half of a measure and let the rhythm continue normally for the last half. However, there is a restriction on using normal patterns for retrigger purposes: the retrigger points must come during sustained sounds in the bass or accompaniment.

In this example from measure 53, four chord events (each with a different bass note) have been entered over a sustained bass sound, providing 8th note accents in the first two beats.

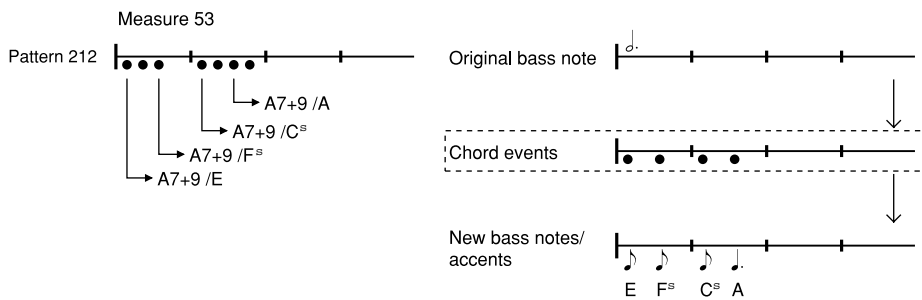

DEMO SONGS 1-6 – CHORD CHARTS

The following charts show the chord progressions used in the six demonstration songs.

Song 1: Boogie

A7	D7	A7	A7	
D7	D7	A7	A7	
E7	D7	A7	E7	:

Song 4: Ballad

D	Dmaj9	G	Asus4 A	
D	Dmaj9	G	A	
D	Dmaj9	G	A	
D	Dmaj9	G	Asus4 A	

Song 2: Funk

A	G	F#m	G	G	A	
A	G	F#m	G	G	G	
A	G	F#m	G	G	A	:
A	G	F#m	E	A		

Song 5: Bossanova

C#maj9	C#maj9	E ^b add9	E ^b add9	
E ^b m7	D9	C#maj9	D9	
C#maj9	C#maj9	E ^b add9	E ^b add9	
E ^b m7	D9	C#maj9	C#maj9	

Song 3: Reggae

G	D	F	C	G	D	F	C	
G	D	F	C	G	D	F	C	
C	G	F	C	G		F		
C		G	F	C		G	F	

Song 6: R & B

Gm7	C7	Gm7	Gm7	
C7	C7	Gm7	Gm7	
D add9	C7	Gm7	D add9	

YAMAHA
YAMAHA CORPORATION