



EXTERNAL **USB 2.0**
USB 1.1

CD-R/RW DRIVE

CRW2200UX SERIES

OWNER'S MANUAL
BEDIENUNGSANLEITUNG
MODE D'EMPLOI
MANUAL DE INSTRUCCIONES

English

Deutsch

Français

Español

20x 10x 40x
CD-R CD-RW CD-ROM



FCC INFORMATION

COMPLIANCE INFORMATION STATEMENT

(DECLARATION OF CONFORMITY PROCEDURE)

Responsible Party: Yamaha Electronics Corporation, USA.
Address: 6660 Orangethorpe Avenue
Buena Park, CA 90620
Telephone: 714-522-9105
Fax: 714-670-0108
Type of Equipment: CD Recordable/Rewritable Drive
Model Name: CRW2200UX

This device complies with Part 15 of the FCC Rules.

Operation is subject to the following conditions:

- 1) this device may not cause harmful interference, and
- 2) this device must accept any interference received including interference that may cause undesired operation.

See user manual instructions if interference to radio reception is suspected.

FCC INFORMATION (U.S.A.)

1. IMPORTANT NOTICE: DO NOT MODIFY THIS UNIT!

This product, when installed as indicated in the instructions contained in this manual, meets FCC requirements. Modifications not expressly approved by Yamaha may void your authority, granted by the FCC, to use the product.

- 2. IMPORTANT:** When connecting this product to accessories and/or another product use only high quality shielded cables. Cable/s supplied with this product MUST be used. Follow all installation instructions. Failure to follow instructions could void your FCC authorization to use this product in the USA.

- 3. NOTE:** This product has been tested and found to comply with the requirements listed in FCC Regulations, Part 15 for Class "B" digital devices. Compliance with these requirements provides a reasonable level of assurance that your use of this product in a residential environment will not result in harmful interference with other electronic devices. This equipment generates/uses radio frequencies and, if not installed and used according to the instructions found in the users manual, may cause interference harmful to the operation of other electronic devices. Compliance with FCC regulations does not guarantee that interference will not occur in all installations. If this product is found to be the source of interference, which can be determined by turning the product "OFF" and "ON", please try to eliminate the problem by using one of the following measures:

Relocate either this product or the device that is being affected by the interference.

Utilize power outlets that are on different branch (circuit breaker or fuse) circuits or install AC line filter/s.

In the case of radio or TV interference, relocate/reorient the antenna. If the antenna lead-in is 300 ohm ribbon lead, change the lead-in to coaxial type cable.

If these corrective measures do not produce satisfactory results, please contact the local retailer authorized to distribute this type of product. If you can not locate the appropriate retailer, please contact Yamaha Electronics Corporation, USA, 6660 Orangethorpe Avenue, Buena Park, CA 90620 U.S.A.

LASER INFORMATION

Laser Product Class: Class 1
Laser Diode Properties
Wavelength: 780-787 nm
Pulse Durations and Max. Output at the lens of the Laser Pickup Unit
Read Mode: 0.7mW (Continuous)
Write Mode: Max. 38mW
 (for 166ns, Min. Cycle 86.6ns)

Laserprodukt-Klasse: Klasse 1
Eigenschaften der Laserdiode
Wellenlänge: 780-787 nm
Impulsdauer und max. Ausgang an der Linse der Laser-Abtasteinheit
Lesemodus: 0,7mW (kontinuierlich)
Schreibmodus: Max. 38mW
 (für 166ns, Zyklusmin. 86,6ns)

Classe du produit laser: Classe 1
Caractéristiques de la diode laser
Longueur d'onde: 780-787 nm
Durée des impulsions et sortie maximum depuis la lentille du bloc capteur optique
Mode de lecture: 0,7mW (continue)
Mode de gravure: max. 38mW
 (pour 166ns, cycle min. 86,6ns)

Clase de producto láser: Clase 1
Propiedades del diodo láser
Longitud de onda: 780-787 nm
Duración del pulso y potencia de salida máxima en el objetivo de la unidad captora láser
Modo de lectura: 0,7mW (continua)
Modo de escritura: máx. 38mW
 (para 166ns, ciclo mínimo 86,6ns)

CAUTION
 Use of controls or adjustments or performance of procedures other than those specified herein may result in hazardous radiation exposure.

ACHTUNG
 Halten Sie sich beim Bedienen und Einstellen der Bedienungselemente sowie bei der Bedienungsabfolge an die Anleitung, da sonst gefährliche Strahlen austreten können.

ATTENTION
 L'emploi de commandes, de réglages ou un choix de procédures différents des spécifications de cette brochure peut entraîner une exposition à d'éventuelles radiations pouvant être dangereuses.

PRECAUCION
 El usar los controles o ajustar o realizar procedimientos diferentes a los especificados aquí resultará en peligrosas exposiciones a la radiación.

VARO! AVATTAESSA JA SUOJALUKITUS OHITETTAESSA OLET ALTTINA NÄKYMÄTTÖMÄLLE LASERSÄTEILYLLE. ÄLÄ KATSO SÄTEESEEN.

VARNING! OSYNLIG LASERSTRÅLNING NÄR DENNA DEL ÄR ÖPPNAD OCH SPÄRREN ÄR URKOPPLAD. BETRAKTA EJ STRÅLEN. STRÅLEN ÄR FARLIG.

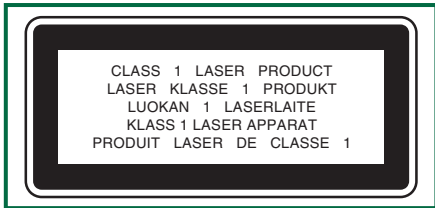

COMPLIES WITH 21 CFR CHAPTER 1, SUBCHAPTER J.

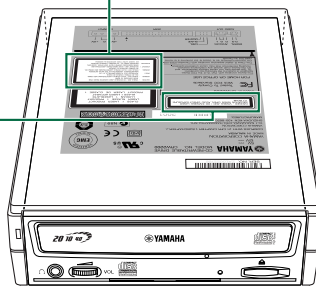



EXTERNAL **USB 2.0**
USB 1.1

CD-R/RW DRIVE

CRW2200UX SERIES

20x 10x 40x
CD-R CD-RW CD-ROM



OWNER'S MANUAL

SAFETY PRECAUTIONS

PLEASE READ THE FOLLOWING WARNING AND CAUTION CAREFULLY TO PROTECT YOUR PERSONAL SAFETY AND PREVENT DAMAGE TO THE DEVICE.

These precautions explain how to use the device correctly and safely, thereby preventing injury to yourself or to others. This section has been sub-divided into a WARNING section and a CAUTION section, according to the likelihood and nature of any potential injuries or damage inflicted. They relate to your personal safety, and also help you minimize the risk of damaging the device. Please read these sections carefully before proceeding.



WARNING

Always follow these basic precautions to prevent short-circuit, damage, fire, or other hazards, and to prevent serious injury or death from electrical shock.

- To avoid risk of electrical shock or fire, do not attempt to open or disassemble the device.
- To avoid risk of eye damage or blindness, do not look inside the device.
- To avoid the risk of personal injury or electrical shock, do not insert your fingers, or foreign objects into the device. Please take particular care if small children are present.
- To avoid the risk of electrical shock, fire, or personal injury, do not expose the device to rain, use it near water, or in damp or wet conditions, or place containers that contain liquids (they may spill into the unit) on the device.
- To avoid risk of personal injury, electrical shock, fire, or damage to the unit, follow the Owner's Manual carefully and set up the unit correctly.
- If unusual smells, sounds or smoke come from the device, turn off the computer immediately to avoid the risk of electrical shock, fire or damage to the device, and return the device to the place of purchase, or alternatively, to your nearest Yamaha dealer (listed at the back of this manual).
- Make sure the computer is electrically grounded to avoid the risk of electrical shock.
- When opening up the computer, unplug it from the electrical outlet (do not touch the plug with wet hands) as there is an increased risk of electrical shock.
- The drive should not be exposed to temperatures outside the range of 5 – 35 °C (41 – 95 °F) to avoid risk of malfunction, fire or personal injury.
- To avoid the risk of electrical shock or fire, be sure to use the correct voltage rating, or the device may not operate properly.
AC adapter Rated Input Voltage SKB2505A : 100 – 120 V AC ± 10%
 SMB2505A : 220 – 240 V AC ± 10%
- Clean the AC power plug regularly, especially the blades, to avoid the risk of insulation failure or fire due to humidity.
- Do not pull on the cord itself when disconnecting from the electrical outlet, or let objects rest or roll over the cord, as the cord can be damaged and cause electrical shock or fire.

- Insert the AC plug firmly, as a poor connection can result in electrical shock or fire.
- Only use the included AC adapter, as malfunction or fire may result.
- Do not connect too many devices to a single electrical outlet, or use voltages exceeding the rated voltage as this may cause overheating and fire.

CAUTION

Always follow these basic precautions to prevent physical injury to yourself or others, or damage to the instrument or other property.

- To avoid the risk of electrical shock or fire, always unplug the computer from the electrical outlet if it will not be used for a prolonged period of time, or if there is a risk of lightning.
- Do not expose the device to excessive vibration, heat, cold or dust, as doing so may result in damage to the unit's front panel or its internal components.
- Do not use the device near other products such as televisions, radios, or speakers as this may cause interference, which can affect the proper operation of the device or other devices.
- To avoid damage to the device or personal injury, always place the device in a stable position.
- Always place the device horizontally to avoid the risk of lost written data.
- Always remove any disc from the disc tray before transporting the device as written data may be lost.
- Use a soft, dry cloth to wipe the device. Do not use benzene, paint thinners, detergents, or chemically treated wiping cloths as these may damage the unit.
Do not place vinyl, plastic, or rubber objects on the device as chemical reactions can cause damage to the device.
- Do not rest your weight on or place heavy objects on the device, or use excessive force on the buttons, switches or connectors, as damage to the unit or personal injury may occur.
- Do not listen to audio with headphones at high volume for prolonged periods of time as your hearing may be damaged as a result.
- Before using the device, always turn down the volume as sudden bursts of sound can result in hearing damage.
- Do not place the device anywhere near sources of magnetic interference as operational stability may be adversely affected.
- Have the device serviced regularly to avoid internal dust buildup that can cause malfunction, damage or fire. For service information, and about service charges, contact the store of purchase, or your nearest Yamaha dealer (listed in the back of this manual).
- Do not allow the plug of the AC adapter to come into contact with metal as a short circuit can result and cause a malfunction or damage to the device.
- Do not wrap the power cord around the AC adapter as it may become disconnected and cause a malfunction.

■ About handling CD-R/RW discs

1. Do not store discs in areas subject to excessive humidity or heat (i.e., in direct sunlight or near a heater).
2. Do not touch the surface of a disc.
When handling a disc, hold it by the edges.
3. Remove dust and dirt from the surface of a disc.
Use an air-blower (i.e., camera lens blower) to remove dust. The surface of a disc may be scratched if wiped with a dry cloth.
4. Do not stick labels on the surface of a disc.
5. Do not write on the surface of a disc except where indicated.
6. Do not clean discs with chemicals or detergents.
7. Do not bend or drop discs.
8. Use only circular discs. Do not use irregularly shaped discs, such as star, heart or card shaped, etc., as these could damage your new CD-R/RW drive.

- 1. The information contained in this manual is subject to change without prior notice.**
- 2. All trademarks contained in this manual belong to their respective owners.**
- 3. Yamaha does not bear any responsibility for a problem that occurs as a result of any operations carried out other than those stated in the manual included with the drive.**
- 4. Reproduction of this manual, either in part or in full, is expressly forbidden.**

■ Precautions for Transportation

Keep the original box for future transportation. Before transporting the device, always put it in the original box. Yamaha does not bear any responsibility for any problem that occurs during transportation with the device not in the original box.

■ Copyrights

When writing to a CD-R/RW, make sure that you do not infringe on any copyrights. It is illegal to copy audio CDs for non-personal use. When backing up software, make sure that you do not infringe on any software copyrights for that product.

■ WARRANTY

YAMAHA AND ITS SUPPLIERS ACCEPT NO LIABILITY FOR THE LOSS OF ANY DATA OR ANY PROBLEMS CAUSED AS A RESULT OF USING THIS PRODUCT. AS A PRECAUTION, IT IS RECOMMENDED THAT THE DISCS BE TESTED AFTER THEY HAVE BEEN WRITTEN TO. FURTHERMORE, UNDER NO CIRCUMSTANCES DOES YAMAHA AND ITS SUPPLIERS GUARANTEE THE RELIABILITY OF THE DISCS.



Table of Contents

Introduction	1
Features of the CRW2200UX Drive	1
Before Use	4
System Requirements.....	4
Supported Discs.....	6
Serial Number	8
Front and Rear of Unit	9
Front Panel	9
Rear Panel	10
Setup Procedures	11
Setup Flowchart.....	11
STEP 1 Set Up the CRW2200UX Drive.....	12
STEP 2 Install the Device Drivers	15
STEP 3 Configuring for the Operating System.....	16
STEP 4 Install the CD Writing Software	17
Operation	18
Loading/Ejecting a Disc.....	18
Ejecting a Disc in an Emergency	19
Disconnecting the CRW2200UX Drive	20
Troubleshooting	21
Appendix	26
Recording Methods	26
About the Firmware	29
LED Indicator Messages	30
CRW2200UX Specifications.....	31
Index.....	34

©2001 YAMAHA CORPORATION. All Rights Reserved.

This document may not, in whole or in part, be copied, photocopied, reproduced, translated, transmitted, or reduced to any electronic medium of machine readable form without prior consent in writing from Yamaha.

Windows is a registered trademark of Microsoft Corporation.

SafeBurn™ is a trademark of Yamaha Corporation.

All other trademarks are the property of their respective companies.



Introduction

Features of the CRW2200UX Drive

High speed writing/reading

The **CRW2200UX** drive supports up to 20X-speed writing of CD-R discs, ^{*1} and up to 10X-speed writing/rewriting of CD-RW discs. ^{*2} Furthermore, the drive supports data reading and digital audio data extraction at up to 40X speed.

USB 2.0 compatible

USB 2.0 provides high-speed data transfer capability (max. speed 480 Mbits/sec.). The transfer speed is about 40 times faster than the conventional USB standard (USB 1.1).

USB's hot swapping capability allows the drive to be plugged in and unplugged even with the computer turned on.

SafeBurn™ (Enhanced write stability technology)

Generous 8MB of buffer memory

Because of the large data storage area, stable disc writing is possible even at fast speeds.

Buffer Underrun Protection

When data transfer from the host PC is interrupted, Buffer Underrun Protection is activated to keep precious CD-R discs from going to waste. (→P. 3)

Optimum Write Speed Control

Before writing to a CD-R, the **CRW2200UX** drive checks the disc's capability and automatically selects the optimum writing speed ^{*3} for greater reliability. The speed you set is the maximum writing speed.

Reliable writing

Yamaha's proprietary Pure-Phase Laser System (patent applied for)

This technology reduces phase interference of the laser beam, so that it projects accurately onto the disc. Jitter value, an important measure of recording quality, has been improved 25% compared with Yamaha models not using this technology.

Running OPC (Optimum Power Control)

Running OPC automatically adjusts the output of the laser according to the characteristics of the disc being used. Running OPC provides greatly enhanced recording reliability for various manufacturer's discs.

High-fidelity digital audio

The **CRW2200UX** drive supports extraction of digital audio data at up to 40X speed, as well as the recording of digital sound with complete fidelity even when writing at 20X speed.

CD TEXT support

Information such as the song name or artist name can be recorded on Audio CDs using CD creation software. The text data on the created disc can be displayed on a CD player that is compatible with the CD TEXT format.

**1 16X- or 20X-speed writing is enabled with the Partial CAV method. (→P. 7)*

**2 10X-speed writing/rewriting is enabled with the CLV method and the 4X-10X Full CAV method. (→P. 8)*

**3 The optimal writing speed automatically selected will be between 8X speed and the maximum speed designated for that disc. If the disc is rated at lower than 8X speed writing, you need to designate the most suitable writing speed manually.*

Buffer Underrun Defined

CD-R/RW drives are equipped with buffer memory. This memory temporarily stores data while a disc is being recorded. When buffer memory becomes empty (due to unexpected interruptions or the system's inability to keep up with the writing process), a writing error occurs. This error is known as a "buffer underrun error."

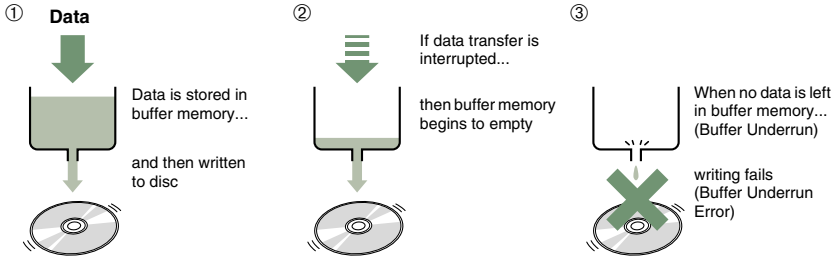

A Buffer Underrun Error will permanently ruin the disc.

Yamaha Buffer Underrun Protection

Buffer Underrun Protection is featured in Yamaha's **CRW2200** series CD-R/RW drives. When a buffer underrun is about to occur, a buffer underrun error is prevented by temporarily suspending the writing process. Writing resumes when enough data has accumulated again in buffer memory. Buffer Underrun Protection on the **CRW2200** series is extremely accurate, resulting in seamless recording between stop and continuation points.

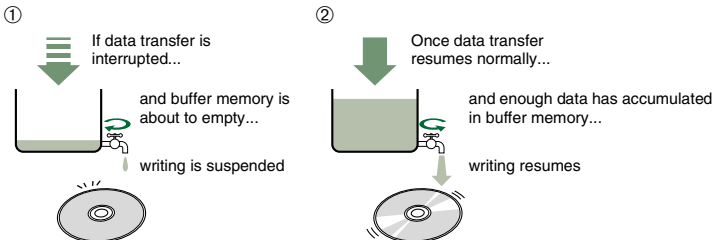

Yamaha Buffer Underrun Protection ensures error-free results.

Test-writing for Buffer Underrun

Test writing is a function to check for the likely occurrence of Buffer Underrun on your computer system.

Most writing software includes test writing functions for this purpose.

When the Buffer Underrun Protection is set to ON (Default), test writing cannot be selected on your writing software.

To use test writing, the Buffer Underrun Protection should be set to OFF.

System Requirements

If your computer doesn't meet the requirements listed below, the **CRW2200UX** drive may not be able to write at the maximum speed.

Computer

- PC/AT-Compatible Computer
- CPU: Pentium II-class or higher, 300 MHz or faster.
- RAM: 64 MB or more
- USB port (USB 2.0 compatible)
- A spare PCI expansion slot or a CardBus slot for a USB interface card (if one hasn't been installed yet).
- CD-ROM drive

Notes

- To install the device drivers, you need a CD-ROM drive other than the **CRW2200UX** drive.
- The **CRW2200UX** drive cannot be used as a boot drive. Furthermore, the **CRW2200UX** drive cannot be used to set up the OS one more time.

USB 2.0 Interface Card (PCI or CardBus)

Your computer requires a USB port in order to connect the **CRW2200UX** drive. To fully utilize the performance of the **CRW2200UX** drive, a USB 2.0 compatible interface card and EHCI (Enhanced Host Controller Interface) compliant driver are also necessary.

If your computer has a USB port with USB 1.1 specifications, we recommend that you install a USB 2.0 compatible interface card.

Notes

- For the latest information about approved USB 2.0 interface cards, refer to the YAMAHA CD-R/RW Drive web site.
URL: <http://www.yamaha.co.jp/english/product/computer/>
- For information on how to purchase the EHCI compliant driver for the USB interface card, or information about the OS supporting the card, refer to the interface card manufacturer web site, or contact user support services.

Connecting the drive to a USB port with USB 1.1

When the **CRW2200UX** drive is connected to a USB 1.1-compliant port on your computer, it operates in accordance with USB 1.1 standard.

For reliable data writing, the Buffer Underrun Protection should be set to ON, and the writing speed should be set to 8X on the writing software.

Reading is 6X speed at the maximum.

USB cable

The USB standard for maximum length of cable between devices is five meters.

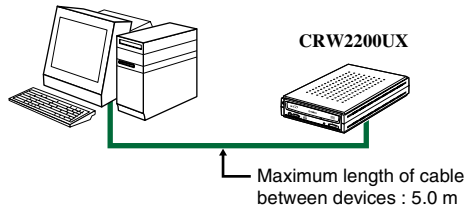

Operating System (OS)

Windows 98 Second Edition, Windows Me, or Windows 2000 Professional

Notes

- For Windows 98 Second Edition, install the included device drivers (storage class drivers) to the PC. For details, refer to the separate manual, "Device Driver Installation Guide", that came with the **CRW2200UX** drive.
- The **CRW2200UX** drive cannot be used with a system that has been booted on MS-DOS or Safe mode.

CD Writing Software

The **CRW2200UX** drive requires a CD writing software to write onto a CD-R/RW disc. Make sure your CD writing software supports the **CRW2200UX** drive.

Note

For details about how to install and use the software, refer to the documentation that came with it.

Hard Drive Space

Writing data on a CD-R/RW disc requires 50 MB to 100 MB of free space as a working area on the hard drive.

When writing data on a CD-R/RW disc after creating an image file, there must be enough free space on the hard drive to store the image file in addition to the working area (a total of up to about 900 MB).





However, this hard drive space for image files is not needed when directly writing onto a CD-R/RW disc from a hard drive or CD-ROM using the **CRW2200UX** drive (on-the-fly writing).

About disk image files

You can collect data files into a single disk image file for a CD-R/RW disc. Also, note that an image file is useful when writing multiple discs with the same content. For further details, refer to the documentation that came with your CD writing software.

Supported Discs

The **CRW2200UX** drive can write to discs that carry the following logos:

	<p>CD-R discs^{*1}</p> <p>The CRW2200UX drive can write to these discs at 1X, 2X, 4X, 8X, 12X, 16X, or 20X speed. These discs can be played back in a CD-ROM drive or a CD player.</p> <hr/> <p>Notes</p> <ul style="list-style-type: none"> • 16X- or 20X-speed writing is enabled with Partial CAV method. (→P. 7) • For 8X or faster writing, use CD-R discs that match their respective writing speeds.
	<p>CD-RW discs^{*2}</p> <p>There are two types of CD-RW discs: those that support write/rewrite speeds of 1X, 2X, and 4X, and those that support only 2X. The CRW2200UX drive can write/rewrite at 2X or 4X speed on the first type of disc, and at 2X on the second type of disc. These discs can be read/played on a device (e.g., CD-ROM drive) that supports “CD-RW.”</p>
	<p>High Speed CD-RW discs^{*3}</p> <p>These discs allow writing/rewriting at 4X to 10X speeds. The CRW2200UX drive can write/rewrite these discs at 4X, 8X, or 10X speed. These discs can be read/played by a CD-RW drive that bears the High Speed CD-RW logo, or by a device (e.g., CD-ROM drive) that supports “CD-RW.”</p> <hr/> <p>Note</p> <p>10X-speed writing/rewriting is enabled with the CLV method, and the 4X-10X Full CAV method. (→P. 8)</p> <p></p> <ul style="list-style-type: none"> • In order to write, erase, or read these discs using a CD-R/RW drive, a drive bearing the High Speed CD-RW logo must be used. When using a CD-ROM drive to read these discs, the drive must be capable of reading CD-RW discs. • If these discs are used in a CD-R/RW drive not bearing the High Speed CD-RW logo, the discs may not be recognized, resulting in the computer not operating correctly or other malfunctions occurring. • Refer to the page at the URL below before attempting to read these discs on a Yamaha CD-R/RW drive not bearing the High Speed CD-RW logo. URL: http://www.yamaha.co.jp/english/product/computer/

*1 Compatible with Orange Book Part 2.

*2 Compatible with Orange Book Part 3 Vol. 1.

*3 Compatible with Orange Book Part 3 Vol. 2.

Note

To find current information about approved discs for the drive, refer to the YAMAHA CD-R/RW Drive web site.

URL: <http://www.yamaha.co.jp/english/product/computer/>

About the Orange Book

The Orange Book standard defines how all recordable discs (including CD-R and CD-RW) are written. Part 2 of the Orange Book standard relates to CD-R discs, and Part 3 to CD-RW discs. The standard was named after the color of the book's cover.

About CD-ROMs

A CD-ROM disc is a compact disc containing high-density read-only data. It has many applications, including the playback of music and video, the archiving of data, as well as on-line documentation. The following are descriptions of each CD-ROM format:

CD-DA: Up to 79 minutes of stereo audio is written in 16-bit resolution at a sampling rate of 44.1 kHz for a 79 minute disc.

Data CD: Up to 700 megabytes of computer data is stored in standard ISO9660 format for a 700 MB disc.

Video CD: These hold movies in which video and audio data has been compressed using MPEG-1 technology.

About Partial CAV (Constant Angular Velocity)

Writing to a CD-R disc is normally done using the CLV (Constant Linear Velocity) method. In this method, the disc rotation speed is adjusted so as to keep a constant data transfer rate at any portion of the disc. In other words, the disc rotation speed will vary in CLV writing.

In contrast, the CAV (Constant Angular Velocity) method uses a constant disc rotation speed for all portions of the disc so that the data transfer rate will vary. Because the CAV method has the advantage of largely increasing the data transfer rate with a minimum load to the drive's mechanism (compared to CLV's rotation speed adjustment), many current CD-ROM drives use the CAV method. CD formats define the constant linear density of written data (data should be written onto the disc at a constant pitch) so that the amount of recorded data per disc rotation will increase as the writing point moves from the inner to the outer. In other words, in CAV writing, the outer portion has an increased data transfer rate.

The **CRW2200UX** drive uses the CAV method in the inner portions as well as the CLV method in the outer portions (Partial CAV) in order to enable up to 20X-speed writing. The drive will control the disc rotation speed to start writing at 12X speed in the inner portions, gradually accelerating up to 20X speed and maintaining 20X speed in the outer portions.

About 10X-speed writing/rewriting of a High Speed CD-RW disc

10X-speed writing/rewriting of a High Speed CD-RW disc is enabled with the CLV method, and the 4X-10X Full CAV method. Commonly, writing/rewriting is enabled with the CLV method. When writing/rewriting with packet writing (→P. 28), you can also select the Full CAV method. For more details, refer to the documentation that came with your CD writing software. (Make sure that your CD writing software supports the Full CAV method.) For direct editing of a file on a CD-RW disc, the Full CAV method is recommended.

Serial Number

When you take the **CRW2200UX** drive out of its packaging, you should immediately write down the serial number found at the bottom of the drive with the bar code. You may need to refer to this number when requesting Customer Support services. In the box below the following diagram, write down the 10-character serial number (consisting of 3 letters followed by 7 digits).

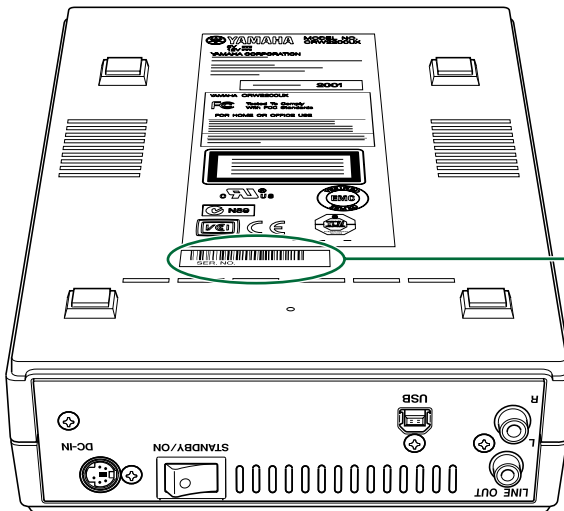

Serial number
(3 letters and 7 digits)

Serial No.									
------------	--	--	--	--	--	--	--	--	--



Front and Rear of Unit

Front Panel

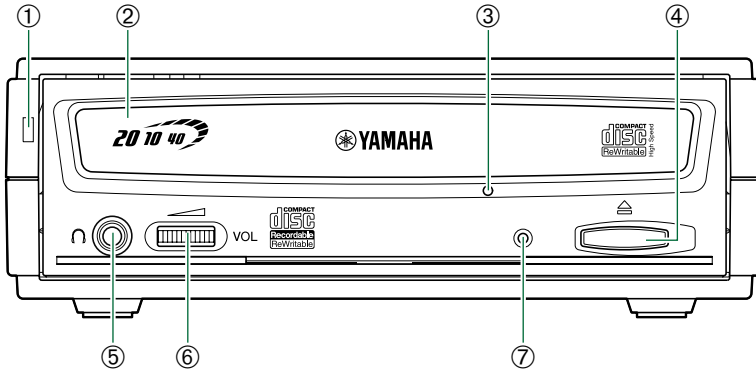

① Power LED

Lights up in green when the power of the drive is turned on.

② Disc tray

The disc tray is used to hold the disc. It slides out from the drive unit when a disc needs to be loaded or unloaded. (→P. 18)

③ Manual eject hole

Only use this if no other method is available for unloading a disc. (→P. 19)

④ Eject button

Press this button when you need to open or close the disc tray. (→P. 18)

⑤ Headphone jack

You can connect stereo headphones to this stereo mini jack and listen to an audio CD loaded in the drive.

⑥ Headphone volume control

Adjust this control to set a suitable volume level when listening to an audio CD using the headphone jack. Slide the knob to the left to decrease the volume and to the right to increase it.

⑦ LED

Indicates the operation status of the CRW2200UX drive. (→P. 30)

Rear Panel

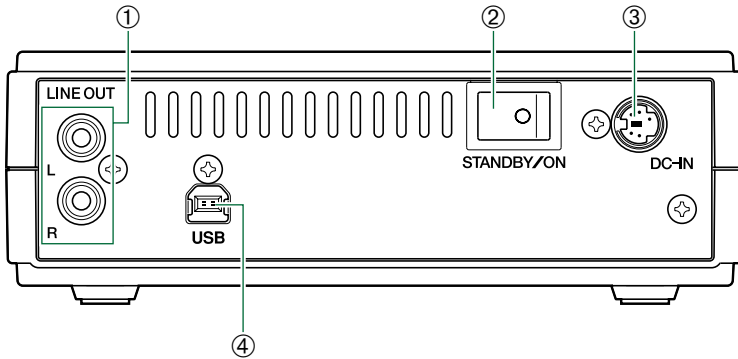

① LINE OUT jacks (L/R)

To listen to audio CDs with the **CRW2200UX** drive, connect these to the line level input (LINE IN) of the stereo equipment with a standard stereo phono cable (sold separately).

② Power switch (STANDBY/ON)

Turns the power on or off. (→P. 12, 14)

③ DC-IN connector

Insert the included AC adapter connector. (→P. 13)

④ USB port

Insert the connector of the included USB cable here. (→P. 12)

Setup Procedures

Setup Flowchart

For easy cross-referencing, the relevant pages in this manual are given.

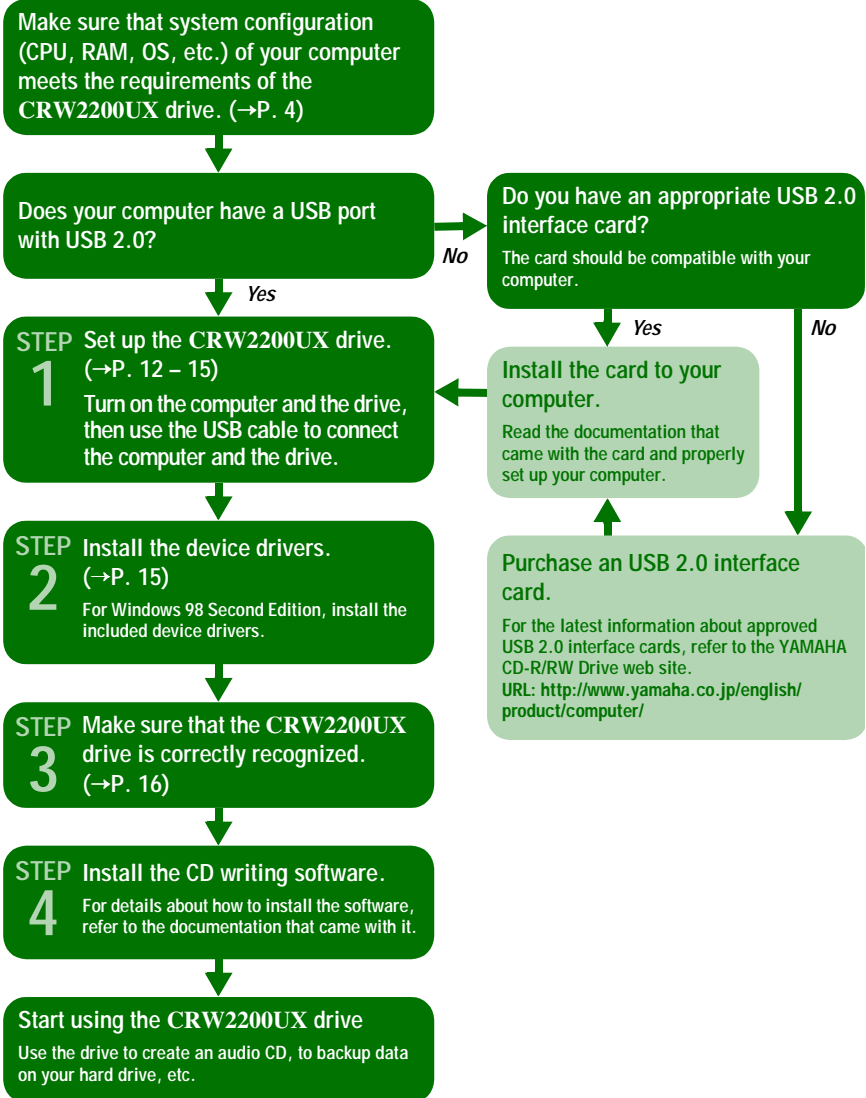

Note

Be sure to mount the **CRW2200UX** drive horizontally.

STEP 1 Set Up the CRW2200UX Drive

- 1 Turn on the computer.
- 2 Make sure that the power switch on the rear panel of the CRW2200UX drive is set to **STANDBY**.

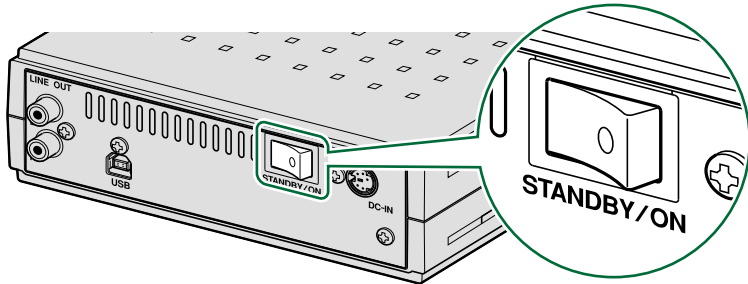

- 3 Connect the included USB cable with the CRW2200UX drive.
The included USB cable has two types of plugs: series A plug and series B plug.

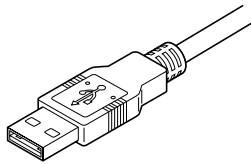

Series A plug

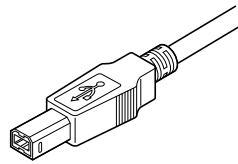

Series B plug

Insert the series B plug (with a square cross section) of the included USB cable in the USB port of the **CRW2200UX** drive.

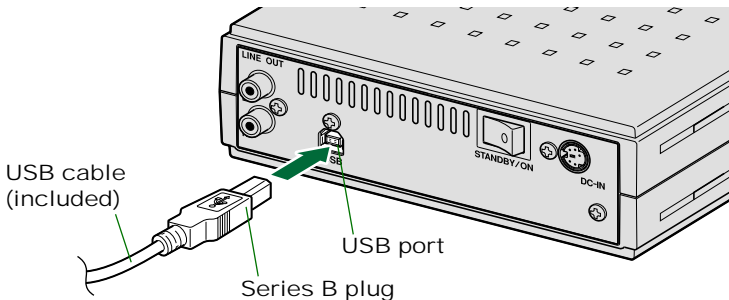

- 4 Connect the included AC adapter to the DC-IN connector of the drive with the arrow on the adapter plug facing left, as shown below.**

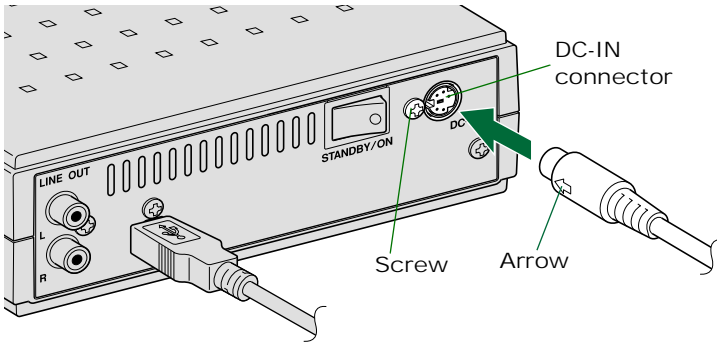

- 5 Connect the included power cable to the AC adapter (①). Connect the other end of the power cable to the AC outlet (②).**

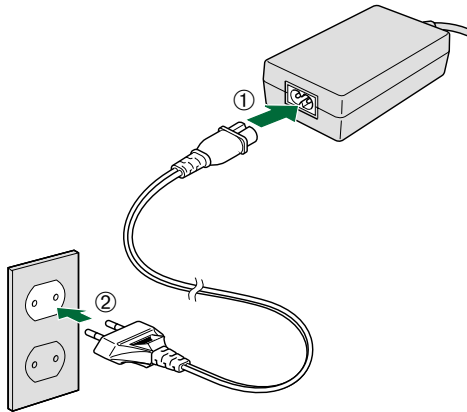

Electrical plugs/sockets vary according to country/region.

Notes

- Operate the drive only with the included AC adapter.
- The included AC adapter may become warm during use. This is not a malfunction.
- With the included AC adapter connected to an AC outlet, even with the power of the drive turned off, power consumption is as shown in the table below. Always unplug the AC adapter from the AC outlet when you do not intend to use the drive for a long time.

AC adapter (model)	Power source	Power consumption
SKB2505A	100 V	2.1 W
	120 V	2.4 W
SMB2505A	220 – 240 V	1.4 W

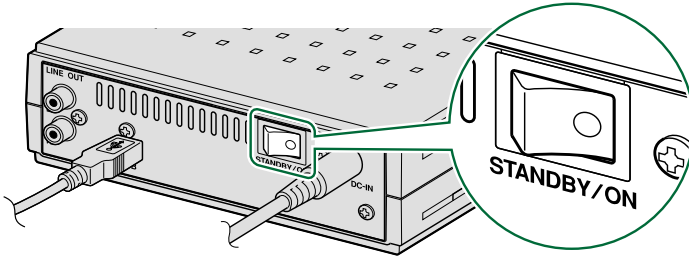
6 Turn on the CRW2200UX drive.

When the power of the **CRW2200UX** drive is turned on, the power LED on the front panel lights up in green.

Power LED

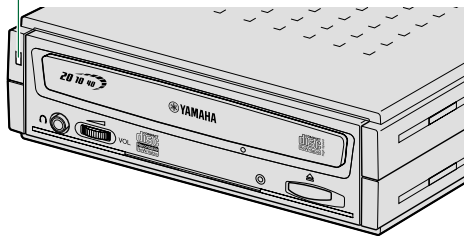

7 Connect the series A plug of the included USB cable to the USB port of the interface card.

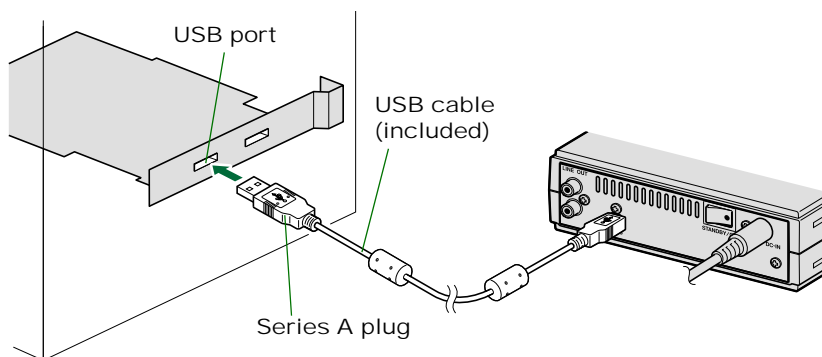

Notes

- Be sure to connect the drive to the USB port of the interface card. If you connect the drive to the computer via a hub, the drive may not operate properly.
- When the **CRW2200UX** drive is connected to a USB 1.1-compliant port on your computer, it operates in accordance with USB 1.1 standard.

STEP 2 Install the Device Drivers

As soon as the **CRW2200UX** drive is connected to the computer, installing of the device drivers starts automatically.
Device drivers are only installed the first time the drive is connected to the computer.

For Windows 98 Second Edition

Install the included device drivers.

For details, refer to the separate manual, “Device Driver Installation Guide”, that came with the **CRW2200UX** drive.

For Windows Me/2000 Professional

Windows Me/2000 Professional standard device drivers are installed automatically.

Note

The device drivers are installed for each USB port. After connecting the drive to a port, if you connect the drive to another port, the screen re-displays messages for installing the drivers again.

STEP 3 Configuring for the Operating System

After connecting the **CRW2200UX** drive to the computer, you can verify that the drive is correctly recognized by your computer.

For Windows 98 Second Edition/Me

Select **Control Panel**, **System**, and open the **Device Manager** tab.

Note

For Windows Me, when the System icon on the Control Panel is not displayed, click the “**view all Control Panel options**” located on the left side of your Windows screen.

Make sure that “**YAMAHA CRW2200E**” (Fig. 1), “**USB CD-ROM,**” and “**USB Mass Storage Device**” (Fig. 2) are displayed on the screen.

Fig. 1

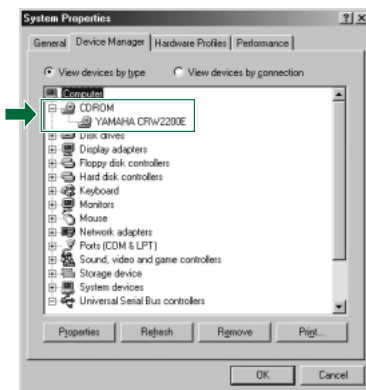
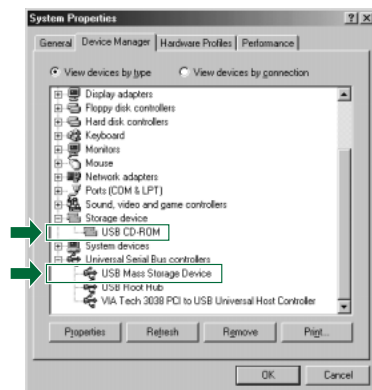

Fig. 2 (Scroll the list down)



** Screen displayed in Windows Me environment.*

For Windows 2000 Professional

Select **Control Panel**, **System**, **Hardware** tab, and clicking on the **Device Manager** button.

Make sure that “**YAMAHA CRW2200E USB Device**” on “**DVD/CD-ROM**” and “**USB Mass Storage Device**” on “**Universal Serial Bus Controllers**” are displayed on the screen.

Notes

- The icon is not displayed on the screen, or if there is an **✘** or **ⓘ** mark, etc., on the left side of the icon, it has not been installed correctly.
- In some environments, a green **?** mark may be placed on the left side of the icon for the above check items. This does not cause any hindrance to the operation of your drive.
- For details about how to use the operating system, refer to the documentation that came with it.

STEP 4 Install the CD Writing Software

For details about how to install and use the software, refer to the documentation that came with it.

Operation

Loading/Ejecting a Disc

You can load and eject a disc (as described below) only when the **CRW2200UX** drive is turned on.

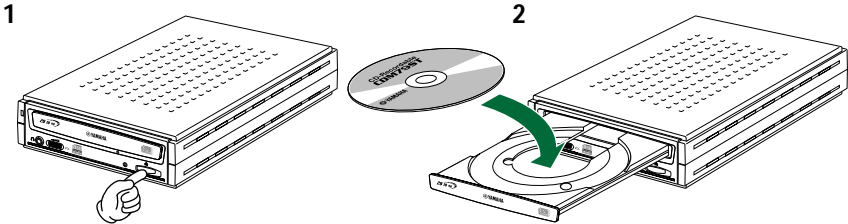

- 1 Open the disc tray by pressing the eject button on the CRW2200UX drive's front panel.**
- 2 Place the disc onto the disc tray with its label or printing facing upward, or remove the disc from the disc tray.**
- 3 Close the disc tray by pressing the eject button again. You can also gently push it closed.**



Load or unload the disc after the disc tray has fully opened. Do not push or pull the disc tray using excessive force. Doing so can damage the drive or the disc.

Note

The disc tray does not open while a disc is being read or written.

Ejecting a Disc in an Emergency

If the disc tray fails to open for some reason, such as a malfunction of the internal spring-loaded mechanism or power outage, it can be opened manually.

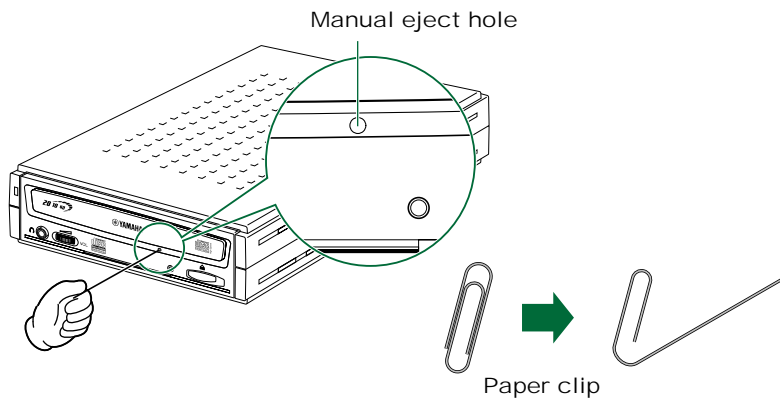

You should attempt to eject a disc manually only as a last resort. Malfunctions may occur if you do this too frequently.

- 1 Turn off the computer and the CRW2200UX drive.**
- 2 Find a pin-like tool with a diameter of 2 mm or less to fit through the manual eject hole on the drive's front panel.**

Note

A straightened paper clip is ideal for this purpose.

- 3 Push the tool gently into the manual eject hole until the spring-loaded mechanism ejects the disc tray and disc.**
- 4 Turn on the CRW2200UX drive to close the disc tray.**

Disconnecting the CRW2200UX Drive

The **CRW2200UX** drive can be connected or disconnected to or from your computer at any time whether the computer is turned on or off (hot swapping).

When removing the **CRW2200UX** drive with the computer turned on, or when turning off the drive with the computer connected, follow the procedure below.

- 1 Exit the writing software.**
- 2 Be sure to remove any disc from the disc tray.**
- 3 For Windows 98 Second Edition, remove the drive.
For Windows Me/2000 Professional, start the “Unplug or Eject Hardware” on the Windows taskbar and perform the necessary steps to remove the drive.**



** Screen displayed in Windows Me environment.*

Note

When writing, be sure not to disconnect the USB cable or any USB devices from the drive, and do not connect any USB devices either.

Troubleshooting

Please refer to the YAMAHA CD-R/RW Drive web site for the latest support information, including troubleshooting information.

YAMAHA CD-R/RW Drive web site

URL: <http://www.yamaha.co.jp/english/product/computer/>

Europe

URL: <http://www.yamaha-it.de/>

The drive does not turn on.

- Are the AC adapter and the power cable connected correctly?
Make sure that the **CRW2200UX** drive is correctly connected to the AC outlet, using the included AC adapter and power cable. (→P. 13)
- Does the power LED on the front panel of the **CRW2200UX** drive light up green if the power switch on the rear panel is turned on? (→P. 14)
If the power LED doesn't light up, consult your local Yamaha dealer (listed at the back of this manual).

The computer does not start up.

- Is the USB interface card installed correctly?
Refer to the documentation that came with your USB interface card.

The **CRW2200UX** drive is not recognized by the operating system. (→P. 16)

- Is the **CRW2200UX** drive correctly connected to the computer, using the included USB cable?
Turn off the computer and the **CRW2200UX** drive, and make sure that the USB cable is connected securely to both the computer and the drive. (→P. 12, 15)
- For Windows 98 Second Edition, have you installed the included device driver?
Windows 98 Second Edition does not recognize the **CRW2200UX** drive unless the included device driver is installed. Install the device driver, following the instructions of the separate manual, "Device Driver Installation Guide", that came with the **CRW2200UX** drive.
- Is the USB interface card correctly recognized by the operating system?
Make sure that the USB interface card is correctly recognized by the operating system. (→P. 16)

If the USB interface is correctly recognized, consult your local Yamaha dealer (listed at the back of this manual).

If the USB interface is not correctly recognized, refer to the documentation that came with your computer or USB interface card. If the problem persists, it may be caused by the device driver. In this case, consult the manufacturer of your USB interface card or a user support service of your computer manufacturer.

The disc tray does not open.

- Is the **CRW2200UX** drive turned on?
The power LED on the front panel of the **CRW2200UX** drive should light up when power is turned on.
- Is any CD writing software being used?
Some CD writing software locks the eject button while it is running on a computer. (If you are using such a software program, the disc tray does not open even if the eject button is pressed.) In this case, perform necessary steps in the software window to eject the disc tray, or exit the CD writing software before pressing the eject button.
- Can the disc tray be opened if the computer is restarted?
Exit all running application software, restart your computer, and then press the eject button of the **CRW2200UX** drive.
- Can the disc tray be opened if the USB cable is disconnected from the drive?
Disconnect the USB cable from the drive while leaving the AC adapter connected to the drive, and press the eject button.
- Turn off your computer and perform the steps described in “Ejecting a Disc in an Emergency.” (→P. 19)
If the disc tray is caught in the drive and does not come out, or if it cannot be opened or closed using the eject button even after it is pulled out manually, consult your local Yamaha dealer (listed at the back of this manual).

The disc is ejected against your will (or it comes out spontaneously).

- Is the disc set correctly (horizontally) on the disc tray?
Set the disc correctly and insert the disc tray once again.
- Isn't the disc dusty or dirty?
Remove dust or dirt from the disc, using an air spray or by wiping with a dry, soft cloth. To avoid damage, always wipe the disc gentry in directions perpendicular to the edge of the disc.
- Does the drive accept other discs (audio CD, CD-ROM, blank CD-R disc, etc.)?
If only a specific disc is ejected, the disc itself may be broken or deformed. If any discs are ejected, consult your local Yamaha dealer (listed at the back of this manual).

No data can be read from a disc.

- Is the disc ejected against your will?
Refer to “The disc is ejected against your will (or it comes out spontaneously).”
(→P. 22)
- Are you sure the disc is of one of the types supported by the drive?
Before use, make sure that the disc is compatible with the **CRW2200UX** drive.
(→P. 31)
- Isn't the disc dusty or dirty?
Remove dust or dirt from the disc, using an air spray or by wiping with a dry, soft cloth. To avoid damage, always wipe the disc gentry in directions perpendicular to the edge of the disc.
- Can data be read from other discs (audio CD, CD-ROM, etc.)?
If no data can be read from a specific disc, data may be written in a format that the drive cannot recognize, or the disc may be damaged or deformed. Note that no data can be read from any blank discs, and also that the **CRW2200UX** drive may sometimes fail to read data correctly from a disc even if the disc is compatible with the drive.
- Does the LED on the front panel of the **CRW2200UX** drive light properly when a disc is inserted?
When a disc is inserted, the LED will light green after flashing green for a moment. (→P. 30)

If no data can be read from a specific disc, data may be written in a format that the drive cannot recognize, or the disc may be damaged or deformed.

If the LED on the front panel remains orange (indicating that the drive cannot recognize the disc) no matter what type of disc is inserted, consult your local Yamaha dealer (listed at the back of this manual).

No data can be read from any CDs, a disc is ejected spontaneously, or the LED remains orange even after a disc has been inserted (normally, the LED will change from orange to green after flashing green for a moment) (→P. 30)

- If any of these problems arises, disconnect the USB cable from the **CRW2200UX** drive while leaving the AC adapter connected to the drive, insert the disc once again. If no data can be read from a specific disc or a specific disc is ejected, it may be caused by the deterioration of the disc itself, including data corruption. However, if the LED remains orange no matter what type of disc is inserted, e.g., an audio CD, CD-ROM or blank CD, consult your local Yamaha dealer (listed at the back of this manual).

The playback of an audio CD (CD-DA) cannot be heard.

- Make sure that powered speakers (optional) are correctly connected to the LINE OUT jacks (L/R) of the **CRW2200UX** drive, using audio cables (optional). (→P. 10)
- For Windows Me, if no sound can be heard through the headphones connected to the headphone jack of the **CRW2200UX** drive or through the speakers with a built-in amplifier connected to the LINE OUT jacks (L/R) on the rear panel of your drive, perform the following steps to change settings.
(If Windows Media Player 7.0 is used in combination with Windows Me, this problem can arise since the digital playback option is activated by default.)

1 The “Properties” setting of the CRW2200UX drive.

- ① Select **Control Panel, System, Device Manager** tab, **YAMAHA CRW2200E Properties**, and open the **Properties** tab.
- ② Uncheck the “Enable digital CD audio for this CD-ROM device” option.

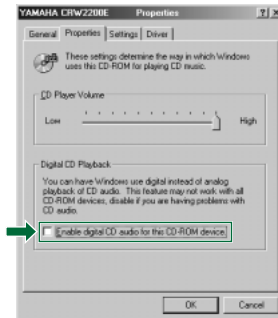

2 The setting of the Windows Media Player.

- ① Start “Windows Media Player.”
- ② Select **Menu, Tools, Options**, and open the **CD Audio** tab.
- ③ Uncheck the “Digital playback” option.

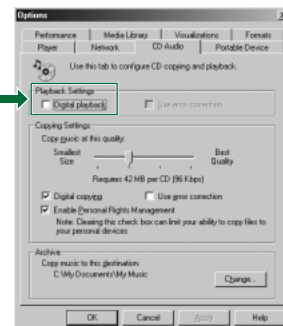

The error message “Buffer Underrun” is displayed.

- If your CD writing software supports the Buffer Underrun Protection, you must activate the Buffer Underrun Protection. For more details, refer to the documentation that came with your CD writing software.
- To prevent the occurrence of a buffer underrun and to increase the efficiency of data writing, try the following:
 - Reduce the data writing speed.
 - Create an image file on the hard drive.
 - Optimize the hard drive. (Defragmentation)
 - Do not start any application software (including screen savers) during data writing.
 - Deactivate the power management for the hard drive.
 - Select “Sync data transfer” for the data transfer mode if a SCSI hard drive, a SCSI CD-ROM, etc., are used with your computer, or select “DMA” if IDE devices are used.
 - Deactivate the Windows Active Desktop.
 - Exit all memory-resident software programs.
 - Check your CD writing software against the documentation that came with it to be sure that there is no problem with it.

Notes

- When the **CRW2200UX** drive is connected to a USB 1.1-compliant port on your computer, it operates in accordance with USB 1.1 standard. For CD writing software settings, it is advisable to activate the Buffer Underrun Protection and to set the data writing speed to 8X.
- A writing error could occur if vibration is applied to the drive while data is being written on the CD-R or CD-RW in it.

Unstable operation.

- Aren't two or more CD writing software programs installed on your computer? Installing two or more CD writing software programs on a computer sometimes makes its operation unstable.
- Isn't the disc dusty or dirty? Remove dust or dirt from the disc, using an air spray or by wiping with a dry, soft cloth. To avoid damage, always wipe the disc gentry in directions perpendicular to the edge of the disc.

Other problems

- Your CD writing software does not recognize the **CRW2200UX** drive. In order for CD writing software to recognize your drive, it must support the **CRW2200UX** drive. Contact the manufacturer of your CD writing software to see whether the software supports the **CRW2200UX** drive.

Recording Methods

Disc-at-Once (DAO)

This method is used to write all data onto a disc in one operation. This method writes multiple pieces of data successively without placing space between them, starting in the innermost track of the disc. Once data is recorded by this method, no data can be added to the same disc even if there is enough space left on it. This method is very useful for making a backup copy of an entire CD.

Example: Ordinary CD-ROM

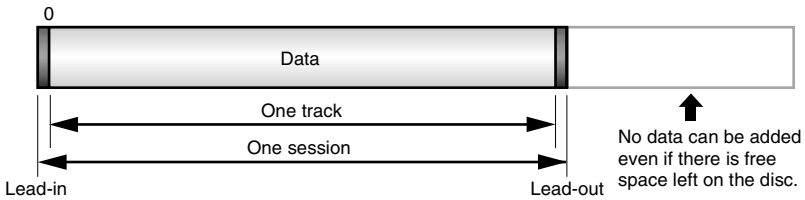

Example: Audio CD

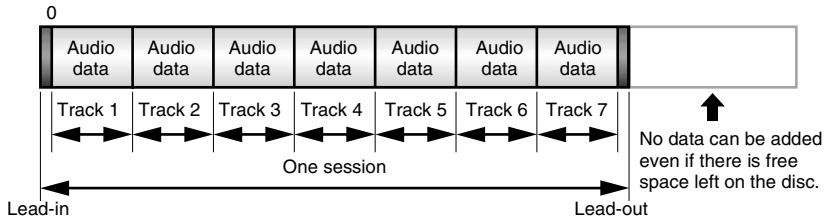

About lead-in and lead-out

Refer to signals written on a disc to indicate the start and end points of a session, respectively. These signals are not included in the data, but they are written in the same session as session management information. In other words, a session is made up of a lead-in, data, and a lead-out.

Track-at-Once (TAO)

This method is used to write data on a disc on a track-by-track basis. A track can be defined as the smallest unit of area that contains an ordinary program, pictorial data, text data, etc. This method allows you to add data to the same disc, one track of data at a time, as long as there is free space left on the disc. Discs that contain data recorded in several different sessions (writing of tracks) are referred to as multi-session discs.

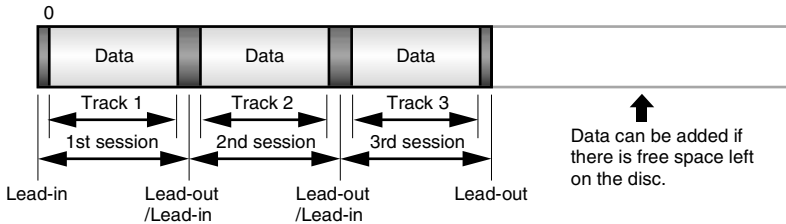

Note

Multi-session discs cannot be played on any ordinary audio CD players, except when data is recorded in a single session (or except for the first session).

Session-at-Once (SAO)

This method is used to write data on a disc on a session-by-session basis. Unlike Track-at-Once described on the previous page, Session-at-Once allows you to record multiple tracks onto a disc at a time. CD EXTRA, for example, uses this method to record multiple pieces of audio data (or multiple tracks) in the first session and information required for computers in the second session. This method allows you to add data to the same disc, one session at a time, as long as there is free space left on it. As is the case with discs containing data recorded by Track-at-Once method, discs containing data recorded by this method can also be called multi-session discs, provided that data is written in several different sessions.

Example: CD EXTRA

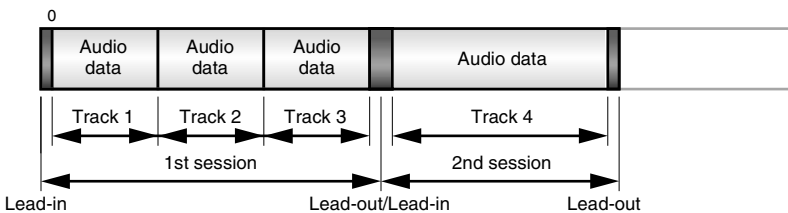

Packet Writing

This method is used to record data onto a disc on a file-by-file basis. This method divides a track into small segments called “packets” so that data can be written on a packet-by-packet basis, which means that you can record data in much the same way as you copy data to a floppy or hard drive by dragging and dropping it on your desktop. With such handiness, Packet Writing is suitable for daily data backup. Also, Packet Writing allows you to add packets to a disc as long as there is free space left on the disc.

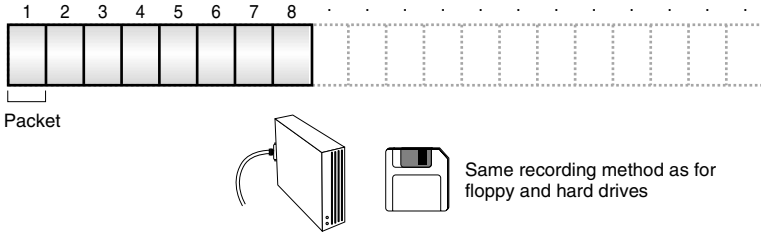

Notes

- Discs need to be formatted before use. Packet Writing allows you to delete data copied (written) on a disc. For CD-RW discs, however, added data is written successively in areas freed up by deleting other data, so that you can record data any number of times until the disc fills up.
- Formatting a CD-RW, using packet writing software, causes its storage capacity (rated capacity printed on the disc) to reduce by about 100 MB because disk space is required for packet writing itself.
- For CD-R discs, deleting data means masking data but not actually removing data. Therefore, deleting data from a CD-R does not increase free space on it. Data can be erased and rewritten 100 times maximum.

About the Firmware

The firmware refers to the operating software designed for your CD-R/RW drive. It is stored in drive's flash memory, so that it can be erased and rewritten. To enhance operation reliability, YAMAHA will continue improving the firmware and make updates to it available. You can find information about the latest firmware in the YAMAHA CD-R/RW Drive web site.

YAMAHA CD-R/RW Drive web site

URL: <http://www.yamaha.co.jp/english/product/computer/>

Europe

URL: <http://www.yamaha-it.de/>

The most up-to-date user support information, including information about the firmware, is available from the above YAMAHA CD-R/RW Drive web site. Please visit the YAMAHA web site regularly to check this information.

Checking the Firmware Version of the CRW2200UX Drive

For Windows 98 Second Edition/Me

Select **Control Panel, System, Device Manager, YAMAHA CRW2200E Properties**, and open the **Settings** tab.

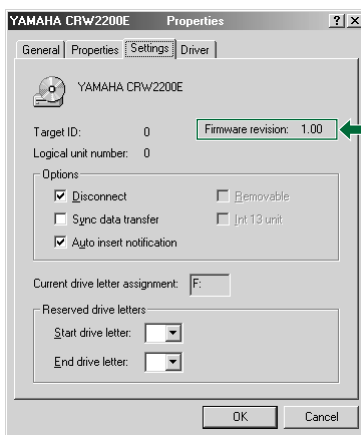

The revision number shown here varies depending on the firmware version of the drive.

** Screen displayed in Windows Me environment.*

For Windows 2000 Professional

The firmware version cannot be displayed, using **Device Manager**. Use your CD writing software to check the firmware version.

LED Indicator Messages

The following table shows the various LED signals and meanings when the CRW2200UX drive is turned on.

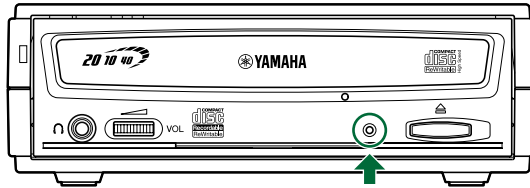

Status	Indicator Messages	LED Color
Ready (with disc)	Lit	Green
Ready (no disc)	Lit	Orange
Tray operation (opening/closing)	Blinking (constant)	Green
Tray fully opened	Out	—
Reading disc information (TOC)	Blinking (constant)	Green
Initial access in writing	Blinking (constant)	Orange
Writing (test mode)	Blinking (constant)	Orange
Writing	Blinking fast (constant)	Orange
Reading	Flashing (inconstant)	Green
Playing	Blinking fast (constant)	Green
Failure	Flashing (inconstant)	Orange

CRW2200UX Specifications

Supported Formats

	Write	Read	Play
CD-DA	●	●	● (*4)
CD TEXT	●	●	●
CD-ROM (*1)	●	●	●
Mixed Mode CD-ROM (CD-ROM+CD-DA)	●	●	● (*4)
CD-ROM XA (*1)	●	●	● (*4)
Photo CD (*1)	● (*2)(*3)	●	● (*4)
Video CD	●	●	● (*4)
CD-i	●	● (*3)	
CD EXTRA (*1)	●	●	● (*4)

*1: includes multisession

*2: suitable disc required

*3: suitable application
software required*4: suitable application software
required for playback

Note

Excludes ADPCM Encode/Decode & Video Encode/Decode functions.

CRW2200UX

Writing Methods

Disc-at-Once (DAO)
Session-at-Once (SAO)
Track-at-Once (TAO)
Packet Writing

Writing/Reading Speed

Writing	CD-R	1X, 2X, 4X, 8X, 12X (CLV), 16X (12X – 16X Partial CAV), 20X (12X – 20X Partial CAV)
	CD-RW	2X, 4X, 8X, 10X (CLV) 4X – 10X Full CAV
Reading	40X (max.) Full CAV	Note) • DATA: 40X (max.) • CD-DA: 40X (max.) in audio extraction • CD-DA: 1X only in audio play • Video CD: 10X (max.) • Session closed disc: 40X (max.) • Session unclosed disc: 12X (max.)
	CD-R	1X, 2X, 4X, 8X, 12X, 16X (12X – 16X Partial CAV), 20X (12X – 20X Partial CAV) writing: CD-R discs specified in Orange Book Part II Ver. 3.1. Note) For 8X or faster writing, use CD-R discs matched their respective writing speeds.
	CD-RW	• 2X writing/rewriting: Rewritable discs specified in Orange Book Part III Volume 1 Version 1.0. • 2X or 4X writing/rewriting: Rewritable discs specified in Orange Book Part III Volume 1 Version 2.0. • 4X, 8X, 10X (CLV), 4X – 10X Full CAV writing/rewriting: Rewritable discs specified in Orange Book Part III Volume 2 Version 1.0.

Data Capacity	700 MB (79 min.) 650 MB (74 min.) 550 MB (63 min.)
Data Transfer Rate (Mode 1)	1X: 150 KB/sec. 16X: 2,400 KB/sec. 2X: 300 KB/sec. 20X: 3,000 KB/sec. 4X: 600 KB/sec. 24X: 3,600 KB/sec. 8X: 1,200 KB/sec. 32X: 4,800 KB/sec. 10X: 1,500 KB/sec. 40X: 6,000 KB/sec. 12X: 1,800 KB/sec.
Data Buffer Size	8 MB (3,224 sectors)
Average Random Access Time	150 msec. (reading)
Sector Size	2,048 – 2,352 bytes
Interface	USB 2.0/1.1
Burst Transfer Rate	USB 2.0 (High speed mode): 480 MB/sec. (max) USB 1.1 (Full speed mode): 12 MB/sec. (max)
Installing Style	Horizontal
Disc Loading Type	Front auto-loading tray loading
Audio Out	Line Out Frequency range: 20 – 20,000 Hz Output level: 700 mVrms
Power Consumption	SKB2505A (100 – 120 V AC) : • 19 W (when writing or reading) • 10 W (standby) SMB2505A (220 – 240 V AC) : • 18 W (when writing or reading) • 9 W (standby)
Operating Environment	Temperature 5 – 35 °C Humidity 25 – 80% RH (no condensation)
Dimensions (includes projection)	Width: 164.0 mm Height: 56.0 mm Depth: 266.2 mm
Weight	1.5 kg

AC adapter

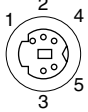
Rated Input Voltage	SKB2505A : 100 – 120 V AC \pm 10% SMB2505A : 220 – 240 V AC \pm 10%										
Rated Input Current	SKB2505A : 0.64 A (100 – 120 V AC) SMB2505A : 0.4 A (220 – 240 V AC)										
Rated Output Voltage	+5 V, +12 V DC										
Rated Output Current	1.5 A										
Terminal Output Polarity	 <table style="display: inline-table; vertical-align: middle;"> <tr><td>1 :</td><td>+12 V DC</td></tr> <tr><td>2 :</td><td>GND</td></tr> <tr><td>3 :</td><td>+5 V DC</td></tr> <tr><td>4 :</td><td>GND</td></tr> <tr><td>5 :</td><td>+5 V DC</td></tr> </table>	1 :	+12 V DC	2 :	GND	3 :	+5 V DC	4 :	GND	5 :	+5 V DC
1 :	+12 V DC										
2 :	GND										
3 :	+5 V DC										
4 :	GND										
5 :	+5 V DC										
Operating Environment	Temperature 0 – 40 °C Humidity 20 – 90% RH (no condensation)										
Dimensions (includes projection)	Width: 63.0 mm Height: 31.5 mm Depth: 112.0 mm										
Weight (includes the power cable)	SKB2505A : 400 g (approx.) SMB2505A : 350 g (approx.)										

The CRW2200UX series complies with the following specifications

Country / Region	Compliance Specifications			Details
	Category	Item	Standards	
USA	Safety	Electrical	UL60950	Information Technology Equipment
		Laser	21CFR1040.10 FDA Chapter 1, Subchapter J	Class 1 Laser Product
	EMC	Emission	47CFR15 FCC Part 15, Subpart B	Class B Computing Device
Canada	Safety	Electrical	CSA C22.2 No. 60950	Information Technology Equipment
	EMC	Emission	ICES-003	Class B Computing Device
EU	Safety	Electrical	EN60950	Information Technology Equipment
		Laser	EN60825	Class 1 Laser Product
	EMC	Emission	EN55022	Class B Information Technology Equipment
		Immunity	EN55024 EN61000-3-2 EN61000-3-3	Information Technology Equipment
Australia New Zealand	EMC	Emission	AS/NZ 3548	Class B Equipment
Japan	EMC	Emission	VCCI	Class B Equipment

Index

A

- AC adapter 13
- Audio CD 26

B

- Buffer Underrun 3
- Buffer Underrun Error 3
- Buffer Underrun Protection 1, 3

C

- CAV 7
- CD EXTRA 27
- CD TEXT 2
- CD Writing Software 5
- CD-DA 7
- CD-R discs 6
- CD-ROM 7, 26
- CD-RW discs 6
- CLV 7
- Configuring for the Operating System
..... 16

D

- Data CD 7
- DC-IN connector 10, 13
- Disc tray 9, 18
- Disc-at-Once (DAO) 26
- Disconnecting the CRW2200UX Drive
..... 20
- Disk image files 5

E

- Eject button 9, 18
- Ejecting a Disc 18
- Ejecting a Disc in an Emergency 19
- Extraction of digital audio data 2

F

- Firmware 29
- Front Panel 9
- Full CAV 8

H

- Hard Drive Space 5
- Headphone jack 9
- Headphone volume control 9
- High Speed CD-RW discs 6
- Hot swapping 1, 20

I

- Install the Device Drivers 15

J

- Jitter value 1

L

- Lead-in 26
- Lead-out 26
- LED 9, 30
- LINE OUT jacks (L/R) 10
- Loading a Disc 18

M

- Manual eject hole 9, 19
- Multi-session 27

O

- Optimum Write Speed Control 1
- Orange Book 7

P

- Packet 28
- Packet Writing 28
- Paper clip 19
- Partial CAV 7
- Power cable 13
- Power LED 9, 14
- Power switch 10, 12, 14
- Pure-Phase Laser System 1

R

- Rear Panel 10
- Recording methods 26
- Running OPC 1

S

SafeBurn™..... 1
Serial Number 8
Series A plug 12
Series B plug 12
Session 26
Session-at-Once (SAO)..... 27
Single session..... 27
Supported Discs 6
Supported Formats 31
System Requirements..... 4

T

Test-writing..... 3
Track 26
Track-at-Once (TAO) 27

U

Unplug or Eject Hardware 20
USB 2.0..... 1
USB 2.0 Interface Card..... 4
USB cable 5, 12, 15
USB port 10, 12, 15

V

Video CD 7

Y

YAMAHA CD-R/RW Drive web site
..... 4, 6, 11, 21, 29

Distributors and Head Offices / Vertriebs- und Hauptgeschäftsstelle Distributeurs et sièges sociaux / Distribuidores y Casas matrices

If you have any questions, please contact your dealer or one of the following companies.

Bei weiteren Fragen wenden Sie sich bitte an Ihren Händler oder eine der folgenden Firmen.

Pour plus de détails sur les produits, veuillez vous adresser à Yamaha ou au distributeur le plus proche figurant dans la liste suivante :

Si tiene alguna pregunta, por favor póngase en contacto con su distribuidor o una de las siguientes empresas:

EUROPE, EASTERN EUROPE and RUSSIA

**Yamaha Elektronik Europa GmbH
IT-Sales Division**
Siemensstrasse 22-34,
D-25462 Rellingen, GERMANY
URL: <http://www.yamaha-it.de/>

TEL: +80092624222

(AUSTRIA, BELGIUM, DENMARK, FINLAND,
FRANCE, GERMANY, HUNGARY, ICELAND,
IRELAND, ITALY, LUXEMBOURG,
NETHERLANDS, NORWAY, PORTUGAL,
SPAIN, SWEDEN, SWITZERLAND, UNITED
KINGDOM)

TEL: +80093067
(MONACO)

If you are calling from outside the countries mentioned
above, or if you can't get through on the Yamaha toll-
free number, use the following number instead:

TEL: +3214400793

U.S.A.

Yamaha Electronics Corporation, USA
6660 Orangethorpe Avenue,
Buena Park, CA 90620, U.S.A.
TEL: +1 714 522 9105
FAX: +1 714 670 0108
URL: <http://www.yamaha.com/>

CANADA

Yamaha Canada Music Ltd.
135 Milner Avenue, Scarborough,
Ontario M1S 3R1, CANADA
TEL: +1 416 298 5664
FAX: +1 416 292 0732
URL: <http://www.yamaha.ca/>

AUSTRALIA

Yamaha Music Australia Pty., Ltd.
Level 1, 99 Queensbridge Street
Southbank, Victoria 3006
AUSTRALIA
TEL: +61 3 9693 5111
FAX: +61 3 9699 2332

SINGAPORE, MALAYSIA, THAILAND, PHILIPPINES, INDIA, VIETNAM, CAMBODIA, MYANMAR, INDONESIA and IRAN

Yamaha Electronics Asia Pte Ltd.
138 Cecil Street
#05-02/03 Cecil Court, Singapore 069538
SINGAPORE
TEL: +65 223 3992
FAX: +65 223 9810

TAIWAN

Yamaha KHS Music Co., Ltd.
11F, No.150, Tun Hua North Rd.
Taipei, TAIWAN R.O.C.
TEL: +886 2 2713 8999
FAX: +886 2 2713 8666
URL: <http://www.yamahakhs.com/>

JAPAN

**Yamaha Corporation
AV & IT Business Group
IT Sales & Marketing Division**
203 Matsunokijima, Toyooka-mura, Iwata-gun,
Shizuoka-ken 438-0192, JAPAN
TEL: +81 539 62 6558
FAX: +81 539 62 5346
URL: <http://www.yamaha.co.jp/english/>



COMPACT
disc
Recordable
ReWritable

COMPACT
disc
ReWritable
High Speed

YAMAHA CORPORATION
X0410A0 CRW2200UX(W)
Printed in Malaysia