

# YAMAHA RX-V590RDS

*Natural Sound Stereo Receiver*

*Récepteur stéréo "Son Naturel"*

*Natural Sound Stereoreceiver*

*Natural Sound Stereoreceiver*

*Sintonizzatore stereo a suono naturale*

*Receptor estéreo de Sonido Natural*

*Natural Sound Stereo Ontvanger*

**OWNER'S MANUAL  
MODE D'EMPLOI  
BEDIENUNGSANLEITUNG  
BRUKSANVISNING  
MANUALE DI ISTRUZIONI  
MANUAL DE INSTRUCCIONES  
GEBRUIKSAANWIJZING**

**SUPPLIED ACCESSORIES**  
**ACCESSOIRES FOURNIS**  
**MITGELIEFERTE ZUBEHORTEILE**  
**MEDFOLJANDE TILLBEHOR**  
**ACCESSORI IN DOTAZIONE**  
**ACCESORIOS INCLUIDOS**  
**BIJGELEVERDE ACCESSOIRES**

- After unpacking, check that the following parts are included.
- Après le déballage, vérifiez que les pièces suivantes sont incluses.
- Nach dem Auspacken überprüfen, ob die folgenden Teile vorhanden sind.
- Kontrollera efter det apparaten packats upp att följande delar finns med.
- Verificare che tutte le parti seguenti siano contenute nell'imballaggio dell'apparecchio.
- Desembale el aparato y verificar que los siguientes accesorios están en la caja.
- Controleer na het uitpakken of de volgende onderdelen voorhanden zijn.

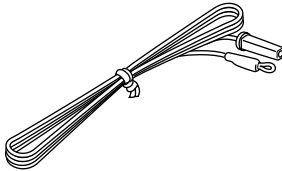
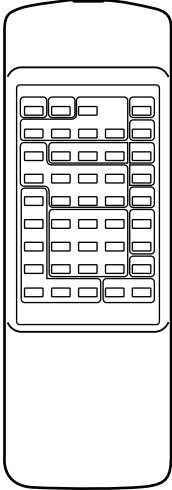
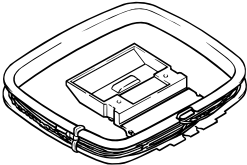
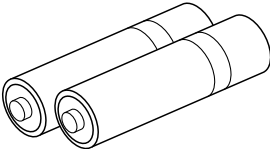
<ul style="list-style-type: none"> <li>• Indoor FM Antenna</li> <li>• Antenne FM intérieure</li> <li>• UKW-Innenantenne</li> <li>• FM inomhusantenn</li> <li>• Antenna FM per interni</li> <li>• Antena FM interior</li> <li>• FM Binnenantenne</li> </ul> 	<ul style="list-style-type: none"> <li>• Remote Control Transmitter</li> <li>• Emetteur de télécommande</li> <li>• Fernbedienungsgeber</li> <li>• Fjärrkontrollsändare</li> <li>• Telecomando</li> <li>• Transmisor del control remoto</li> <li>• Afstandbediening</li> </ul> 
<ul style="list-style-type: none"> <li>• AM Loop Antenna</li> <li>• Cadre-antenna AM</li> <li>• MW-Rahmenantenne</li> <li>• AM ramantenn</li> <li>• Antenna AM ad anello</li> <li>• Antena de cuadro de AM</li> <li>• AM Lusantenne</li> </ul> 	<ul style="list-style-type: none"> <li>• Batteries (size AA, R6, UM-3)</li> <li>• Piles (taille AA, R6, UM-3)</li> <li>• Batterien (Größe AA, R6, UM-3)</li> <li>• Batterier (storlek AA, R6, UM-3)</li> <li>• Batterie (dimensioni AA, R6, UM-3)</li> <li>• Pilas (tamaño AA, R6, UM-3)</li> <li>• Batterijen (maat AA, R6, UM-3)</li> </ul> 

This product complies with the radio frequency interference requirements of the Council Directive 82/499/EEC and/or 87/308/EEC.

Cet appareil est conforme aux prescriptions de la directive communautaire 87/308/CEE.

Diese Geräte entsprechen der EG-Richtlinie 82/499/EWG und/oder 87/308/EWG.

Detta apparat överholder det gældende EF-direktiv vedrørende radiostøj.

Questo apparecchio è conforme al D.M.13 aprile 1989 (Direttiva CEE/87/308) sulla soppressione dei radiodisturbi.

Este producto está de acuerdo con los requisitos sobre interferencias de radio frecuencia fijados por el Consejo Directivo 87/308 CEE.

Dit product voldoet aan de EEG normen betreffende radio-frekventie storingen 82/499/EEG en/of 87/308/EEG.

## FEATURES

---

- **5 Speaker Configuration**
  - Front: 70W + 70W (8Ω) RMS Output Power, 0.04% THD, 20–20,000 Hz
  - Center: 70W (8Ω) RMS Output Power, 0.07% THD, 1 kHz
  - Rear: 20W + 20W (8Ω) RMS Output Power, 0.3% THD, 1 kHz
- **Digital Sound Field Processor**
  - 6 Programs for Digital Sound Field Processing
  - 2 Programs for Dolby Surround Decoding (DOLBY PRO LOGIC and DOLBY PRO LOGIC ENHANCED)
- **Automatic Input Balance Control for Dolby Surround**
- **Test Tone Generator for Easier Speaker Output Balance Adjustment**
- **3 Center Channel Modes (NORMAL/WIDE/PHANTOM)**
- **Multi-Functions for RDS Broadcast Reception**
- **40-Station Random Access Preset Tuning**
- **Automatic Preset Tuning**
- **Preset Station Shifting Capability (Preset Editing)**
- **IF Count Direct PLL Synthesizer Tuning System**
- **Video Signal Input/Output Capability (Including S Video Connections)**
- **SLEEP Timer**
- **Remote Control Capability**

## CONTENTS

---

Supplied Accessories .....	2	Receiving RDS Stations .....	23
Caution .....	4	Using Digital Sound Field Processor (DSP) .....	27
Profile of This Unit .....	5	Setting the SLEEP Timer .....	31
Speaker Setup for This Unit .....	6	Remote Control Transmitter .....	32
Connections .....	7	Notes about the Remote Control Transmitter .....	33
Speaker Balance Adjustment .....	13	Troubleshooting .....	34
Basic Operations .....	16	Specifications .....	35
Tuning Operations .....	19		
Preset Tuning .....	20		

# CAUTION : READ THIS BEFORE OPERATING YOUR UNIT.

1. To assure the finest performance, please read this manual carefully. Keep it in a safe place for future reference.
2. Install this unit in a cool, dry, clean place – away from windows, heat sources, sources of excessive vibration, dust, moisture and cold. Avoid sources of humming (transformers, motors). To prevent fire or electrical shock, do not expose the unit to rain or water.
3. Never open the cabinet. If something drops into the set, contact your dealer.
4. Do not use force on switches, controls or connection wires. When moving the unit, first disconnect the power plug and the wires connected to other equipment. Never pull the wires themselves.
5. The openings on the cabinet assure proper ventilation of the unit. If these openings are obstructed, the temperature inside the cabinet will rise rapidly and eventually damage the circuits. Therefore, avoid placing objects against these openings and do not install the unit where the flow of air through the ventilation openings could be impeded.
6. Always set the VOLUME control to “– ∞” before starting the audio source play. Increase the volume gradually to an appropriate level after playback has been started.
7. Do not attempt to clean the unit with chemical solvents; this might damage the finish. Use a clean, dry cloth.
8. Be sure to read the “TROUBLESHOOTING” section regarding common operating errors before concluding that the unit is faulty.
9. When not planning to use this unit for long periods of time (ie., vacation, etc.), disconnect the AC power plug from the wall outlet.
10. To prevent lightning damage, disconnect the AC power plug and disconnect the antenna cable when there is an electrical storm.
11. Grounding or polarization – Precautions should be taken so that the grounding or polarization of an appliance is not defeated.
12. AC outlet  
Do not connect audio equipment to the AC outlet on the rear panel if that equipment requires more power than the outlet is rated to provide.

## IMPORTANT

Please record the serial number of this unit in the space below.

Serial No.:

The serial number is located on the rear of the unit. Retain this Owner's Manual in a safe place for future reference.

## WARNING

TO REDUCE THE RISK OF FIRE OR ELECTRIC SHOCK, DO NOT EXPOSE THIS UNIT TO RAIN OR MOISTURE.

## For U.K. customers

If the socket outlets in the home are not suitable for the plug supplied with this appliance, it should be cut off and an appropriate 3 pin plug fitted. For details, refer to the instructions described below.

**Note:** The plug severed from the mains lead must be destroyed, as a plug with bared flexible cord is hazardous if engaged in a live socket outlet.

## Special Instructions for U.K. Model

### IMPORTANT

THE WIRES IN THE MAINS LEAD ARE COLOURED IN ACCORDANCE WITH THE FOLLOWING CODE:

Blue: NEUTRAL

Brown: LIVE

As the colours of the wires in the main lead of this apparatus may not correspond with the coloured markings identifying the terminals in your plug, proceed as follows:

The wire which is coloured BLUE must be connected to the terminal which is marked with the letter N or coloured BLACK. The wire which is coloured BROWN must be connected to the terminal which is marked with the letter L or coloured RED. Make sure that neither core is connected to the earth terminal of the three pin plug.

The apparatus is not disconnected from the AC power source as long as it is connected to the wall outlet, even if the apparatus itself is turned off.

You are the proud owner of a Yamaha stereo receiver –an extremely sophisticated audio component. The Digital Sound Field Processor (DSP) built into this unit takes full advantage of Yamaha’s undisputed leadership in the field of digital audio processing to bring you a whole new world of listening experiences. Follow the instructions in this manual carefully when setting up your system, and this unit will sonically transform your room into a wide range of listening environments –movie theater, concert hall, and so on. In addition, you get incredible realism from Dolby-encoded video sources using the built-in Dolby Pro Logic Surround Decoder. Please read this operation manual carefully and store it in a safe place for later reference.

## Digital Sound Field Processing

---

What is it that makes live music so good? Today’s advanced sound reproduction technology lets you get extremely close to the sound of a live performance, but chances are you’ll still notice something missing: the acoustic environment of the live concert hall. Extensive research into the exact nature of the sonic reflections that create the ambience of a large hall has made it possible for Yamaha engineers to bring you this same sound in your own listening room, so you’ll feel all the sound of a live concert.

What’s more, our technicians, armed with sophisticated measuring equipment, have even made it possible to capture the acoustics of a variety of venues such as an actual concert hall, theater, etc. to allow you to accurately recreate one of several actual live performance environments, all in your own home.

## Dolby Pro Logic Surround

---

The Dolby Pro Logic Surround Decoder program lets you experience the dramatic realism and impact of Dolby Surround movie theater sound in your own home. Dolby Pro Logic gets its name from its professional-grade steering logic circuitry, which provides greater effective front and rear channel separation for a much higher degree of realism than the “passive” Dolby Surround circuits found in less sophisticated home audio/video equipment. Dolby Pro Logic Surround provides a true center channel, so that there are four independent channels, unlike passive Dolby Surround which has in effect only three channels: left, right, and rear. This center channel allows listeners seated in even less-than-ideal positions to hear the dialog originating from action on the screen while getting a stereo effect as well.

This Dolby Pro Logic Surround Decoder employs a digital signal processing system. This system increases sound stability at each channel and minimizes crosstalk between channels compared to conventional analog Dolby signal processing.

In addition, this unit features a built-in automatic input balance control. This circuit always presents you the best surround conditions without performing manual adjustments.

## Dolby Pro Logic Surround + DSP

---

You can also enjoy a combination of Dolby Pro Logic Surround and DSP in the sound field program “  PRO LOGIC ENHANCED”.

It recreates the surround effect of a movie theater, effectively duplicating its multiple surround loudspeaker system, completely surrounding the listener with the sounds of the action taking place on the screen.

# SPEAKER SETUP FOR THIS UNIT

## SPEAKERS TO BE USED

This unit is designed to provide the best sound-field quality with a 5 speaker configuration. The speakers to be used with this unit will be mainly front speakers, rear speakers, and a center speaker. (You can omit the center speaker. Refer to the “**4-Speaker Configuration**” shown below.)

The front speakers are used for the main source sound and the effect sound. They will probably be the speakers of your present stereo speaker system. The rear speakers are used for the effect sound. And the center speaker is used for the center sound (dialog etc.) encoded with the Dolby Surround. The rear and center speakers do not need to be equal in power to the front speakers. However, all the speakers should have high enough power handling to accept the maximum output of this unit.

## SPEAKER CONFIGURATION

### 5-Speaker Configuration

This configuration is the most effective and recommended one. In this configuration, the center speaker is necessary as well as the rear speakers. If the digital sound field program **DOLBY PRO LOGIC** or **DOLBY PRO LOGIC ENHANCED** is selected, conversations will be output from the center speaker and the ambience will be excellent.

- Set the center channel mode to the “**NORMAL**” or “**WIDE**” position. (For details, refer to page 14.)

### 4-Speaker Configuration

The center speaker is not used in this configuration. If the digital sound field program **DOLBY PRO LOGIC** or **DOLBY PRO LOGIC ENHANCED** is selected, the center sound is output from the left and the right front speakers. However, the sound effect of other programs can be the same as that of the 5-speaker configuration.

- Be sure to set the center channel mode to the “**PHANTOM**” position. (For details, refer to page 14.)

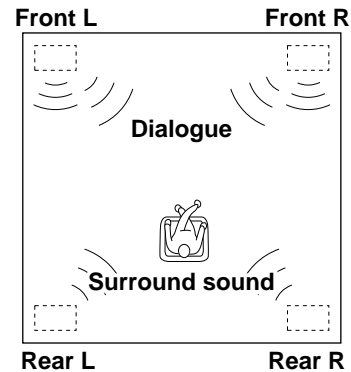
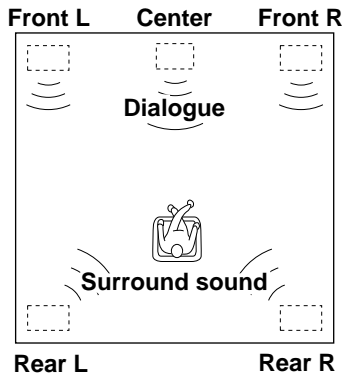

## SPEAKER PLACEMENT

The recommended speaker configuration, the 5-speaker configuration, will require two speaker pairs: **front speakers** (your normal stereo speakers), and **rear speakers**, plus a **center speaker**. When you place these speakers, refer to the following.

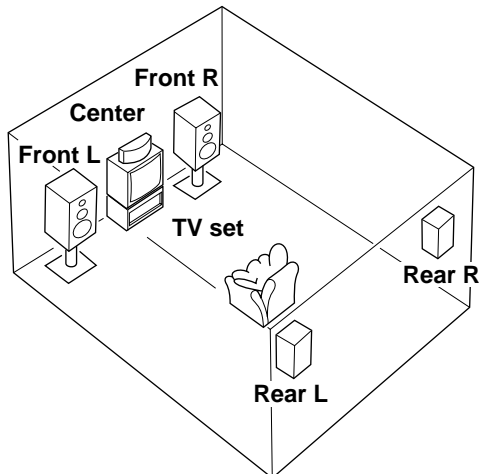

- Front:** In normal position. (The position of your present stereo speaker system.)
- Rear:** Behind your listening position, facing slightly inward. Nearly six feet (approx. 1.8 m) up from the floor.
- Center:** Precisely between the front speakers. (To avoid interference with TV sets, use a magnetically shielded speaker.)

# CONNECTIONS

Before attempting to make any connections to or from this unit, be sure to first switch OFF the power to this unit and to any other components to which connections are being made.

## CONNECTIONS WITH OTHER COMPONENTS

When making connections between this unit and other components, be sure all connections are made correctly, that is to say L (left) to L, R (right) to R, “+” to “+” and “-” to “-”. Also, refer to the owner’s manual for each component to be connected to this unit.

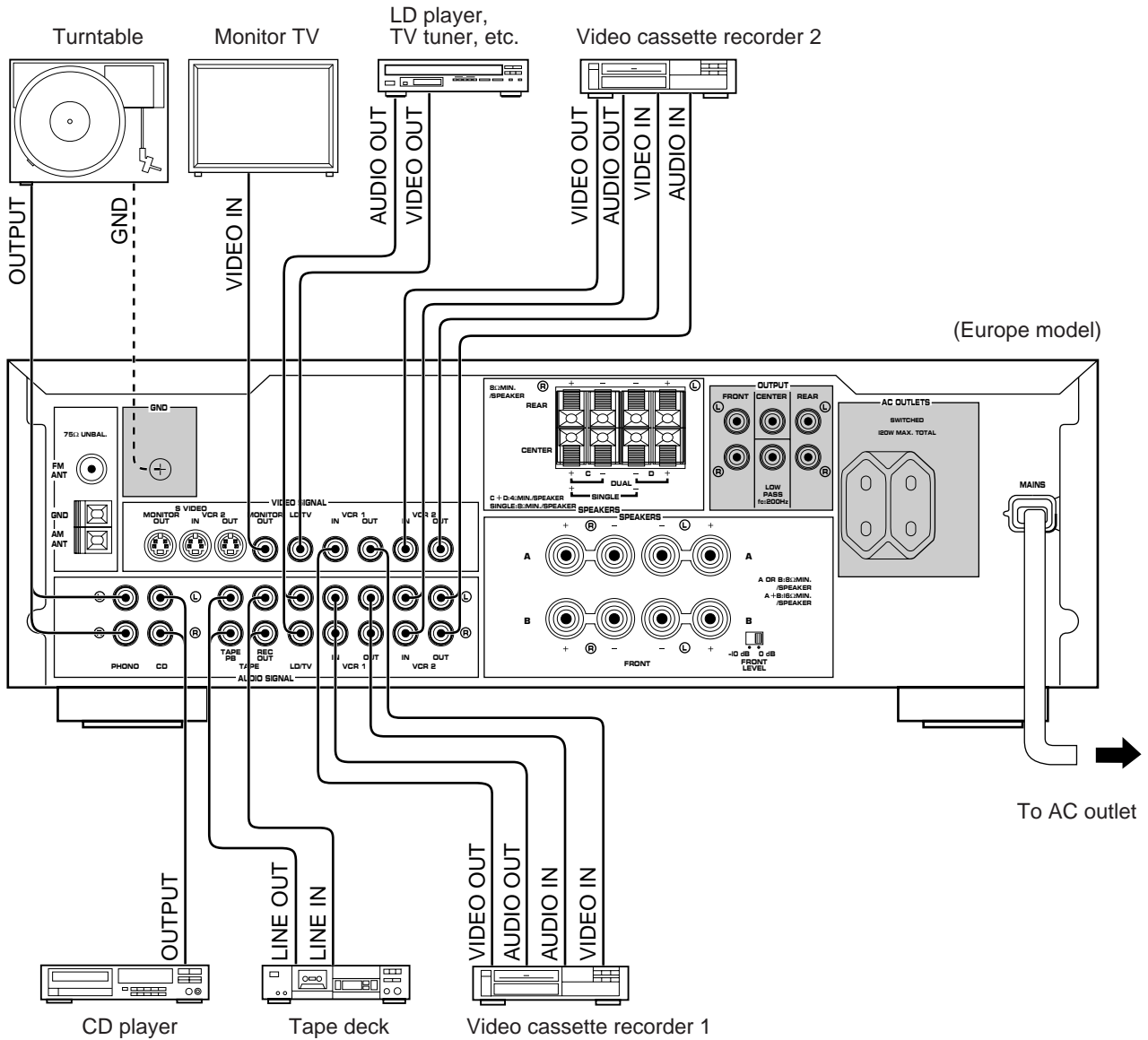

 : Refer to “**ABOUT THE ACCESSORY TERMINALS**” on page 11.

## CONNECTING TO S VIDEO TERMINALS

If you have a video cassette recorder and a monitor equipped with "S" (high-resolution) video terminals, those terminals can be connected to this unit's **S VIDEO** terminals. Connect the video cassette recorder's "S" video input and output terminals to this unit's **S VIDEO VCR 2 IN** and **OUT** terminals respectively, and connect the monitor's "S" video input terminal to this unit's **S VIDEO MONITOR OUT** terminal. Otherwise, connect the video cassette recorder's composite video terminals to this unit's composite video terminals, and connect the monitor's composite video input terminal to this unit's composite **MONITOR OUT** terminal.

**Note**  
If video signals are sent to both **S VIDEO** input and composite input terminals, the signals will be sent to their respective output terminals independently.

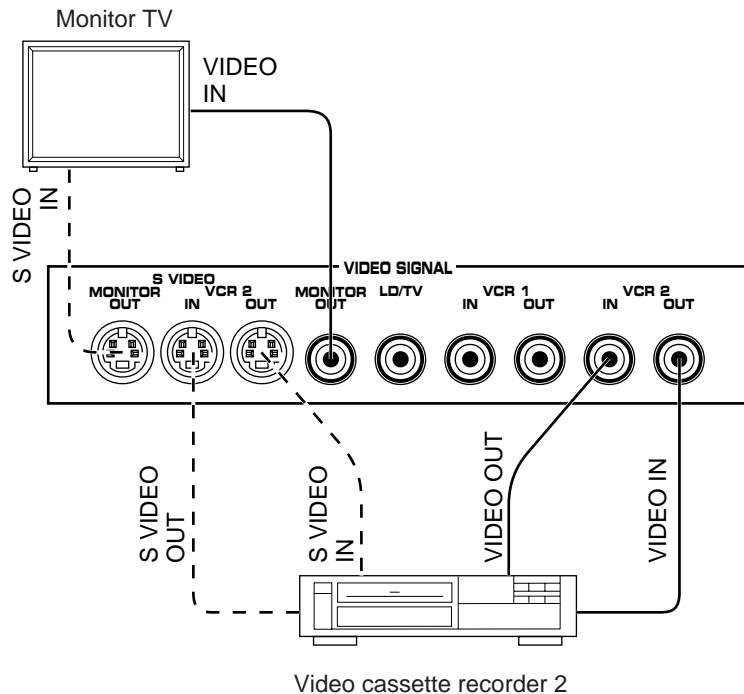

## CONNECTING TO VIDEO AUX TERMINALS (ON THE FRONT PANEL)

These terminals are used to connect any video input source such as a camcorder to this unit.

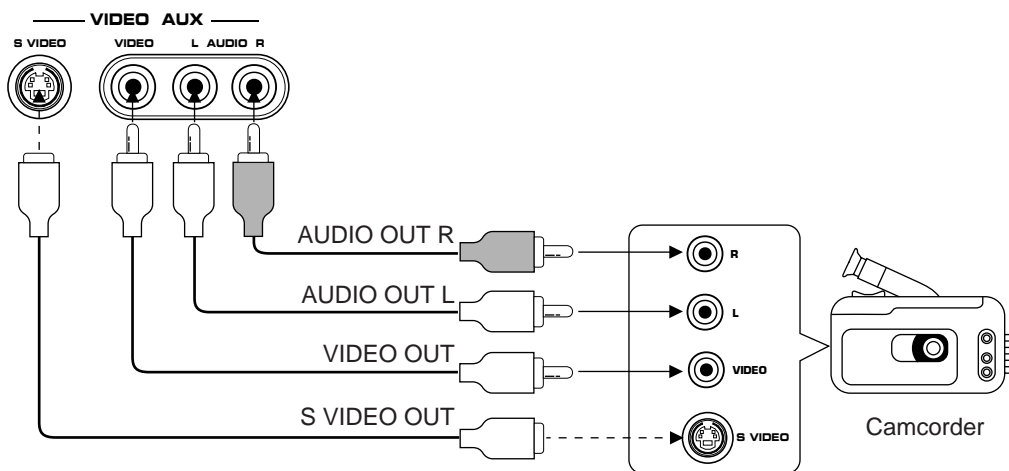



# CONNECTING SPEAKERS

Connect the respective speakers to this unit as figured below.

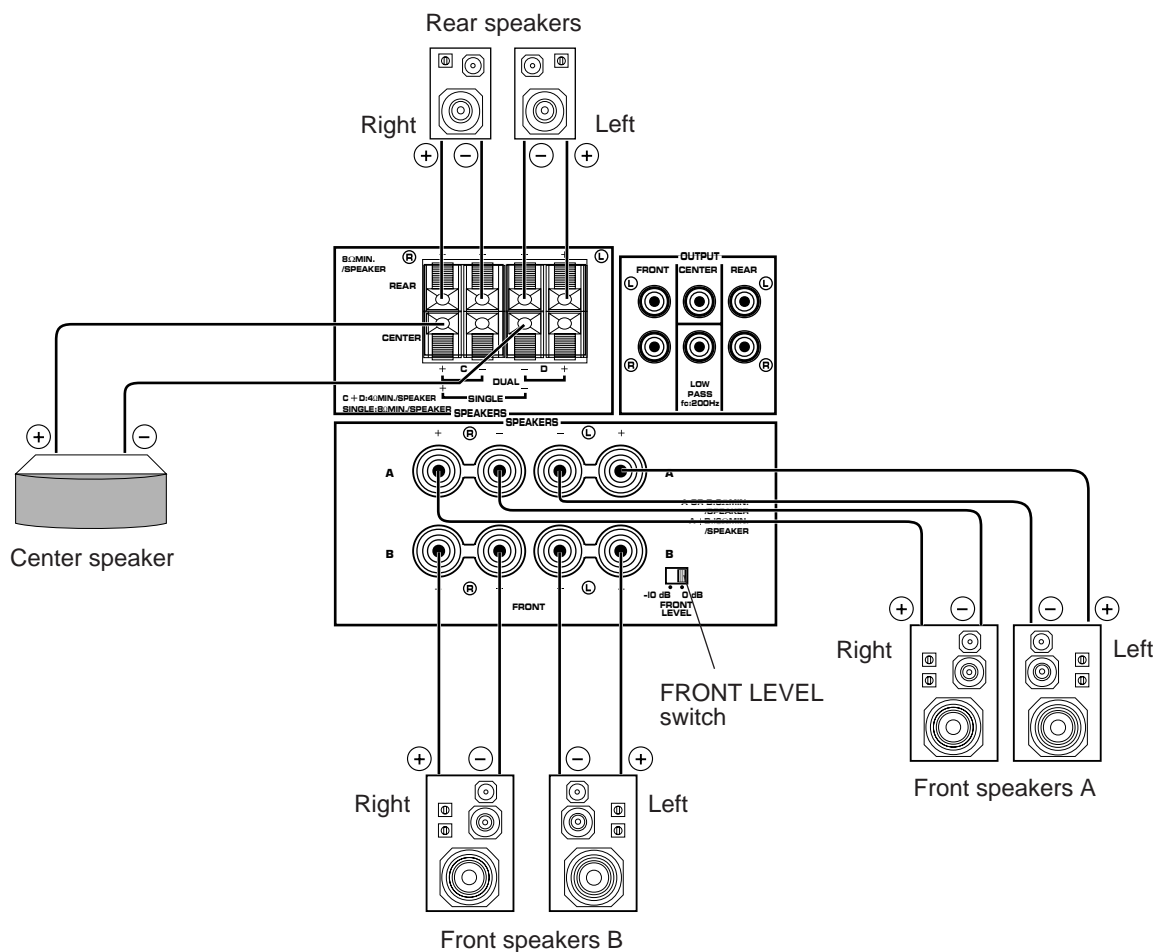

### Note on front speaker connection:

One or two speaker systems can be connected to this unit. If you connect only one speaker system, connect it to either the **SPEAKERS A** or **B** terminals.

### Note on center speaker connection:

One or two center speakers can be connected to this unit. If you cannot place the center speaker on or under the TV, it is recommended to use two center speakers and place them on both sides of the TV to orient the center sound at the center position. For connecting two center speakers, follow the method shown below.

**FRONT LEVEL switch**  
 Normally set to "0 dB". If desired, you can decrease the output level at the **FRONT SPEAKERS** terminals by 10 dB by setting this switch to "-10 dB".

-10 dB    0 dB  
**FRONT LEVEL**

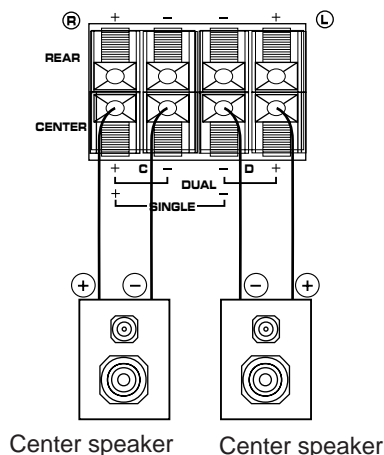

## How to Connect:

Connect the **SPEAKERS** terminals to your speakers with wire of the proper gauge, cut as short as possible. If the connections are faulty, no sound will be heard from the speakers. Make sure that the polarity of the speaker wires is correct, that is, + and – markings are observed. If these wires are reversed, the sound will be unnatural and will lack bass.

**Do not let the bare speaker wires touch each other and do not let them touch the metal parts of this unit as this could damage this unit and/or speakers.**

### Note

Use speakers with the specified impedance shown on the rear of this unit.

### For connecting to the FRONT SPEAKERS terminals

Red: positive (+)  
Black: negative (-)

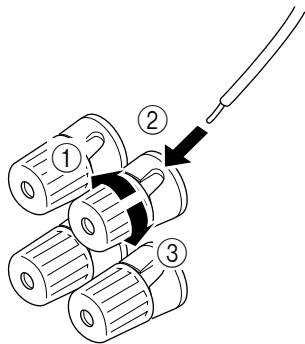

- ① Unscrew the knob.
- ② Insert the bare wire.  
[Remove approx. 5mm (1/4") insulation from the speaker wires.]
- ③ Tighten the knob and secure the wire.

### For connecting to the REAR and CENTER SPEAKERS terminals

Red: positive (+)  
Black: negative (-)

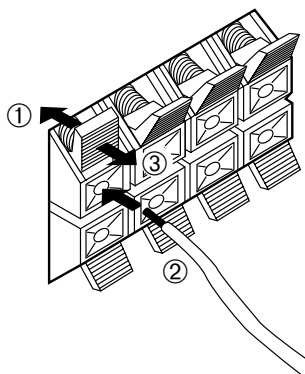

- ① Press up the tab.
- ② Insert the bare wire.  
[Remove approx. 5mm (1/4") insulation from the speaker wires.]
- ③ Release down the tab and secure the wire.

## ABOUT THE ACCESSORY TERMINALS

### AC OUTLET(S) (SWITCHED)

(Europe model) ..... 2 SWITCHED OUTLETS  
 (U.K. model) ..... 1 SWITCHED OUTLET  
 Use these to connect the power cords from your components to this unit.

The power to the **SWITCHED** outlets is controlled by this unit's **POWER** switch or the provided remote control transmitter's **POWER** key. These outlets will supply power to any component whenever this unit is turned on.

The maximum power (total power consumption of components) that can be connected to the **SWITCHED AC OUTLET(S)** is 120 watts.

### GND terminal (For turntable use)

Connecting the ground wire of the turntable to this terminal will normally minimize hum, but in some cases better results may be obtained with the ground wire disconnected.

### LOW PASS terminal

This terminal is for output to a monaural amplifier driving a subwoofer. Only frequencies below 200 Hz from the front and center channels are output.

### FRONT OUTPUT terminals

These terminals are for front channel line output. There is no connection to these terminals when you use the built-in amplifier.

However, if you drive front speakers with an external stereo power amplifier, connect the input terminals of the external amplifier (MAIN IN or AUX terminals of a power amplifier or an integrated amplifier) to these terminals.

### REAR OUTPUT terminals

These terminals are for rear channel line output. There is no connection to these terminals when you use the built-in amplifier.

However, if you drive rear speakers with an external stereo power amplifier, connect the input terminals of the external amplifier (MAIN IN or AUX terminals of a power amplifier or an integrated amplifier) to these terminals.

### CENTER OUTPUT terminal

This terminal is for center channel line output. There is no connection to this terminal when you use the built-in amplifier. However, if you drive a center speaker with an external power amplifier, connect the input terminal of the external amplifier to this terminal.

#### ADDING A SUBWOOFER

You may wish to add a subwoofer to reinforce the bass frequencies.

Connect the **LOW PASS** terminal to the INPUT terminal of the subwoofer amplifier, and connect the speaker terminals of the subwoofer amplifier to the subwoofer.

With some subwoofers, including the Yamaha Active Servo Processing Subwoofer System, the amplifier and subwoofer are in the same unit.

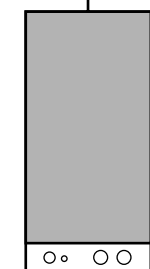
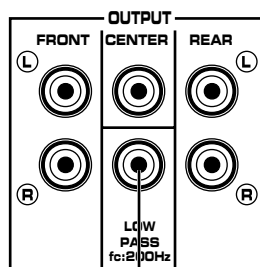

Subwoofer system

# ANTENNA CONNECTIONS

- Each antenna should be connected to the designated terminals correctly, referring to the following diagram.
- Both AM and FM indoor antennas are included with this unit. In general, these antennas will probably provide sufficient signal strength. Nevertheless, a properly installed outdoor antenna will give clearer reception than an indoor one. If you experience poor reception quality, an outdoor antenna may result in improvement.

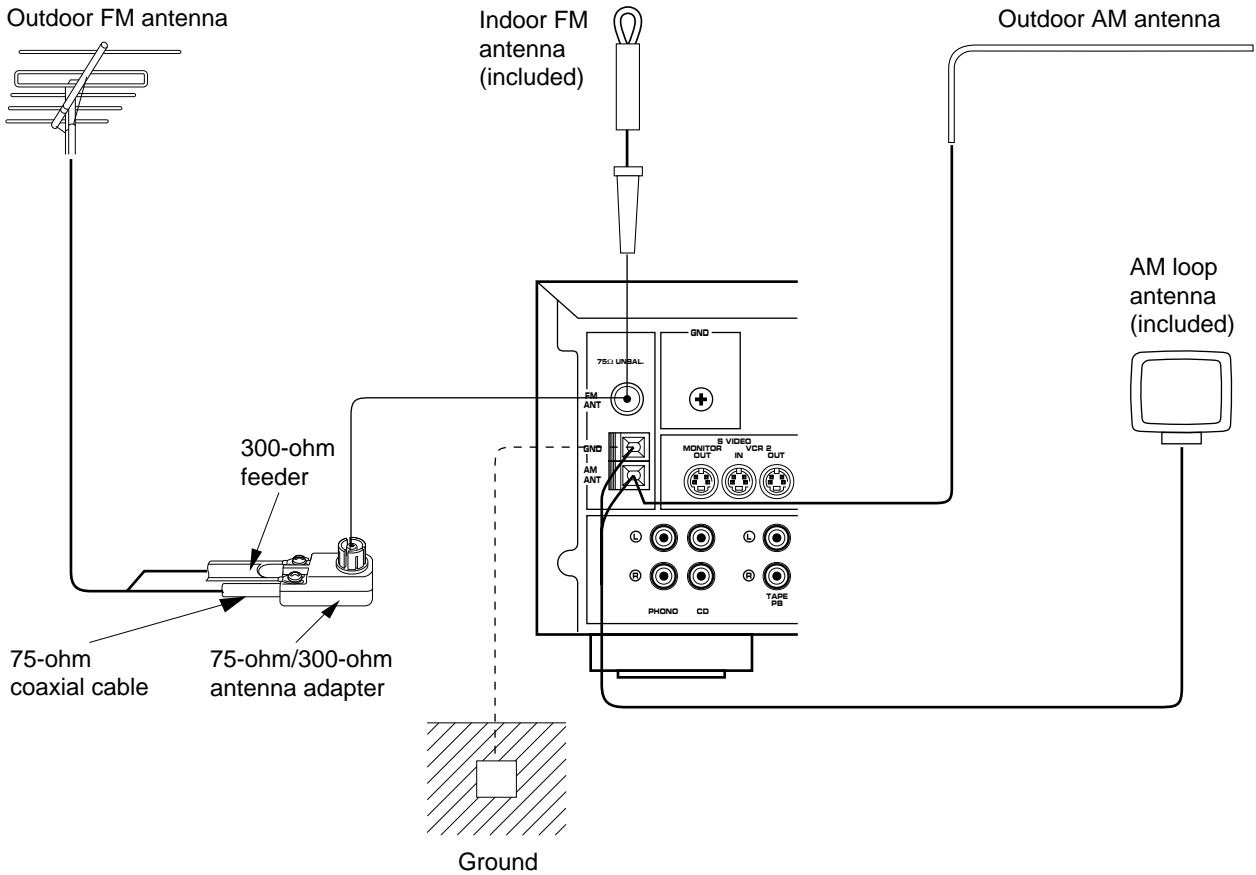

## Connecting the AM loop antenna

1

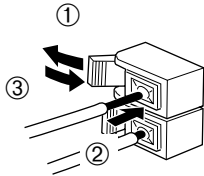

2

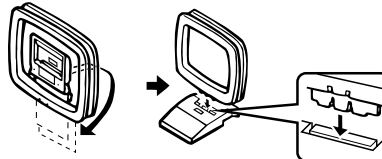

3



Orient so that the best reception is obtained.

- \* The AM loop antenna should be placed apart from the main unit. The antenna may be hung on a wall.
- \* The AM loop antenna should be kept connected, even if an outdoor AM antenna is connected to this unit.

## GND terminal

For maximum safety and minimum interference, connect the **GND** terminal to a good earth ground. A good earth ground is a metal stake driven into moist earth.

## Notes

- When connecting the indoor FM antenna, insert its connector into the **FM ANT** terminal firmly.
- If you need an outdoor FM antenna to improve FM reception quality, either 300-ohm feeder or coaxial cable may be used. In locations troubled by electrical interference, coaxial cable is preferable.

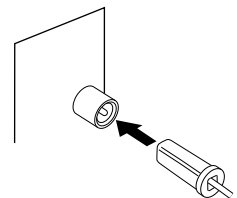

# SPEAKER BALANCE ADJUSTMENT

This procedure lets you adjust the sound output level balance between the front, center, and rear speakers using the built-in test tone generator. With this adjustment, the sound output level heard at the listening position will be the same from each speaker. This is important for the best performance of the digital sound field processor.

**The adjustment of each speaker output level should be done at your listening position with the remote control transmitter. Otherwise, the result may not be satisfactory.**

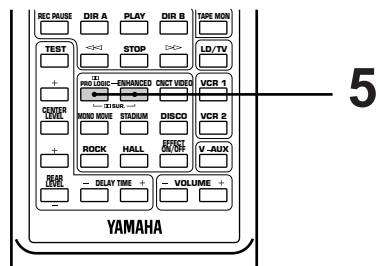
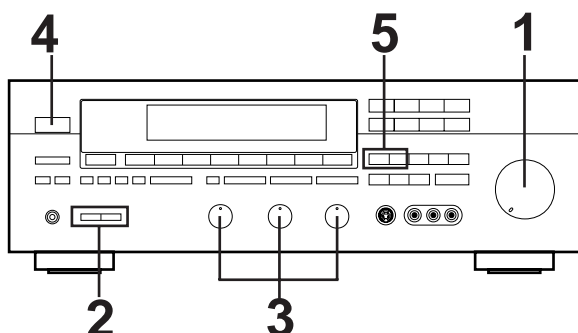

**1**

Set to the "∞" position.

**2** Select the front speakers to be used.

\* If you use two front speaker systems, press both the A and B switches.

**3**

Set to the "0" position.

**4**

**5** Select the  PRO LOGIC or  PRO LOGIC ENHANCED mode, so that the corresponding name is illuminated on the display.

**CONTINUED**

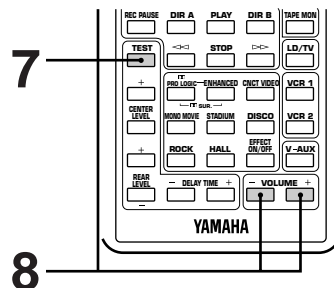
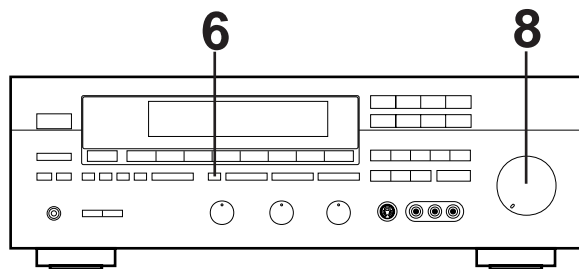

**6** Select the center channel output mode according to your speaker configuration.  
(Refer to “**SPEAKER CONFIGURATION**” on page 6.)

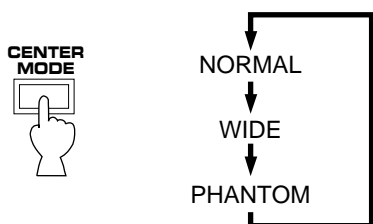

On the feature of each mode, refer to the “**Note**” shown below.

**Note**

In step 6, when you select the center channel output mode, note the following.

**For 5 speaker configuration)**

**NORMAL:** Select this mode when you use a center speaker that is smaller than the front speakers. In this mode, the bass tone will be output from the front speakers.

**WIDE:** Select this mode when you use the center speaker approximately same sized as the front speakers.

**For 4 speaker configuration)**

**PHANTOM:** Select this mode when you do not use the center speaker. The center sound will be output from the left and right front speakers.

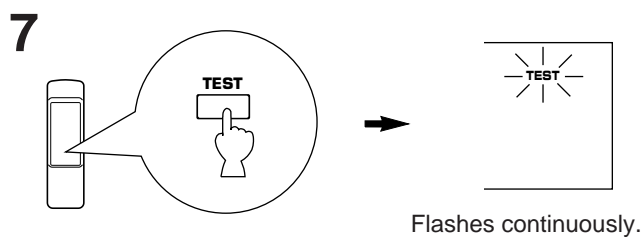

**8** Turn up the volume.

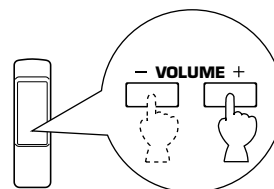

You will hear a test tone (like pink noise) from the left front speaker, then the center speaker, then the right front speaker, and then the rear speakers, for about two seconds each. The display changes as shown below.

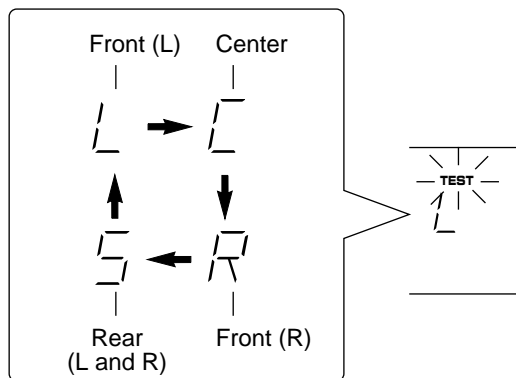

\* The test tone from the left rear speaker and the right rear speaker will be heard at the same time.

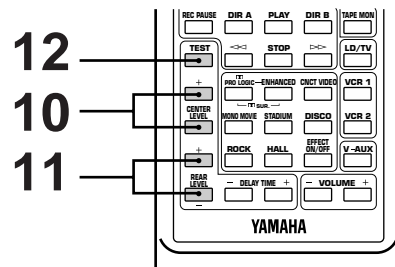
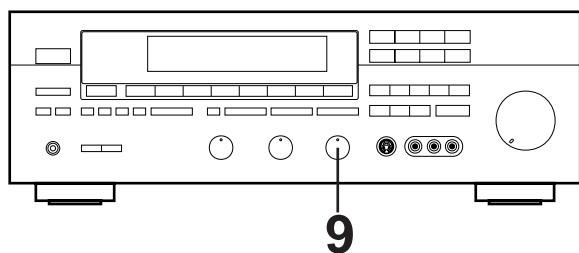

**9** Adjust the **BALANCE** control so that the effect sound output level of the left front speaker and the right front speaker are the same.



**10** Adjust the sound output level of the center speaker to be at the same level as that of the front speakers with the **CENTER LEVEL** keys.

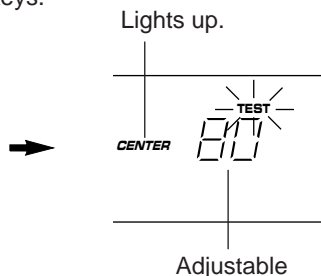
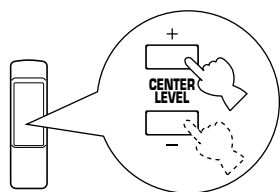

**11** Adjust the sound output level of the rear speakers to be at the same level as that of the front speakers with the **REAR LEVEL** keys.

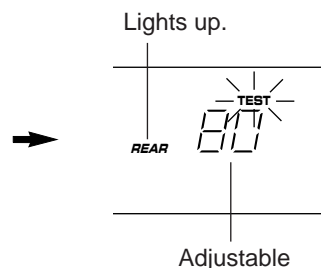
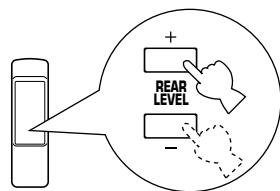

**12** Cancel the test tone.

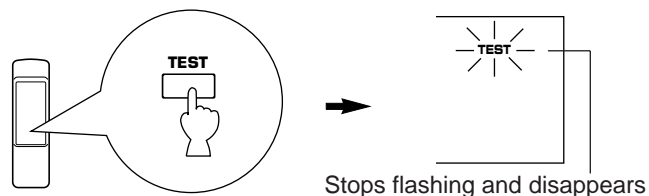

**Notes**

- Once you have completed these adjustments, you can adjust whole sound level on your audio system by using the **VOLUME** control (or the **VOLUME** keys on the remote control transmitter).
- If you use external power amplifiers, their volume controls may also be adjusted to achieve proper balance.
- In step 10, if the center channel mode is in the "PHANTOM" position, the sound output level of the center speaker cannot be adjusted. This is because in this mode, the center sound is automatically output from the left and right front speakers.
- If there is insufficient sound output from the center and rear speakers, you may decrease the front speaker output level by setting the **FRONT LEVEL** switch on the rear panel to "−10 dB".

# BASIC OPERATIONS

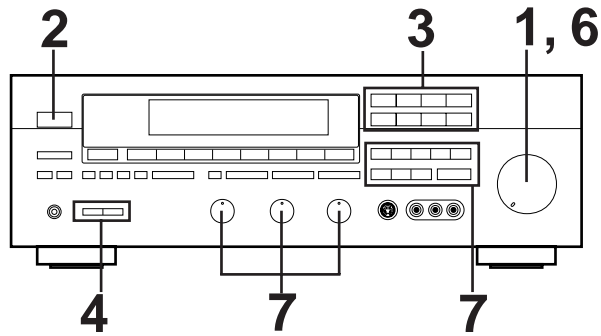

## TO PLAY A SOURCE

1

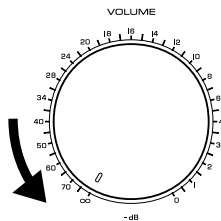

Set to the "∞" position.

2

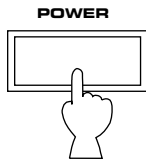

3

Select the desired input source by using the input selector buttons.  
(For video sources, turn the TV/monitor ON.)

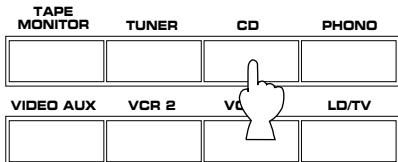

\* The name of the selected input source will appear in the display.

4

Select the front speakers to be used.

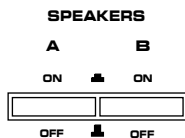

\* If you use two front speaker systems, press both the A and B switches.

5

Play the source. (For detailed information on the tuning operation, refer to page 19.)

6

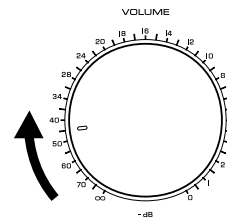

Adjust to the desired output level.

7

If desired, adjust the **BASS, TREBLE, BALANCE** controls, etc. (refer to page 18) and use the digital sound field processor. (Refer to page 29.)

### Notes on using the input selector buttons

- Note that pressing on each input selector button selects the source which is connected to the corresponding input terminals on the rear panel.
  - \* To select the source connected to the **VIDEO AUX** terminals on the front panel, press **VIDEO AUX**.
- The selection of **TAPE MONITOR** cannot be canceled by pressing another input selector button. To cancel it, press **TAPE MONITOR** again.
  - When you select a button other than **TAPE MONITOR**, make sure that **TAPE MONITOR** is not also selected.
- If you select the input selector button for a video source without canceling the selection of **TAPE MONITOR**, the playback result will be the video image from the video source and the sound from the audio tape.
- Once you play a video source, its video image will not be interrupted even if the input selector button for an audio source is selected.

### To turn off the power

Press the **POWER** switch again.



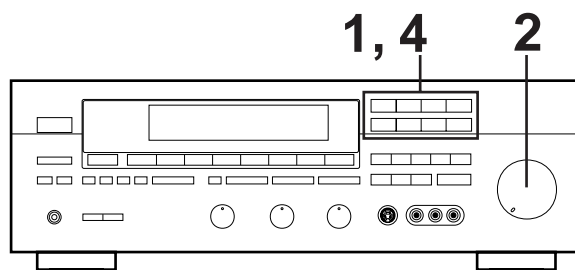

## TO RECORD A SOURCE TO TAPE (OR DUB FROM TAPE TO TAPE)

- 1** Select the source to be recorded.

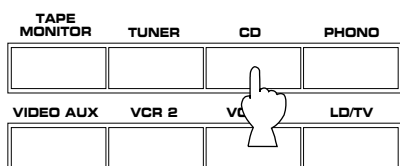

- 2** Play the source and then turn the **VOLUME** control up to confirm the input source. (For detailed information on the tuning operations, refer to page 19.)

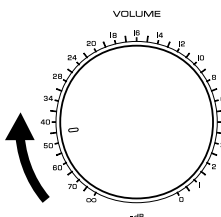

- 3** Set the tape deck or VCR to the recording mode.

- 4** If the tape deck is used for recording, you can monitor the sounds being recorded by pressing **TAPE MONITOR**.

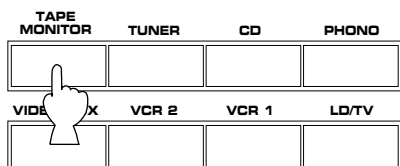

**Note**  
**DSP, VOLUME, BASS, TREBLE** and **BALANCE** control settings have no effect on the material being recorded.

## Selecting the SPEAKER system

Because one or two speaker systems (as front speakers) can be connected to this unit, the **SPEAKERS** switches allow you to select speaker system **A** or **B**, or both at once.

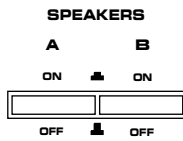

## Adjusting the BALANCE control

Adjust the balance of the output volume to the left and right speakers to compensate for sound imbalance caused by speaker location or listening room conditions.



### Note

This control is effective only for the sound from the front speakers.

## Adjusting the BASS and TREBLE controls

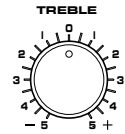

**BASS** : Turn this clockwise to increase (or counter-clockwise to decrease) the low frequency response.

**TREBLE** : Turn this clockwise to increase (or counter-clockwise to decrease) the high frequency response.

### Note

These controls are effective only for the sound from the front speakers.

## When you listen with headphones

Connect the headphones to the **PHONES** jack. You can listen to the sound to be output from the front speakers through headphones.

When listening with headphones privately, set both the **SPEAKERS A** and **B** switches to the **OFF** position and switch off the digital sound field processor (so that no DSP program name is illuminated on the display) by pressing the **EFFECT** switch.

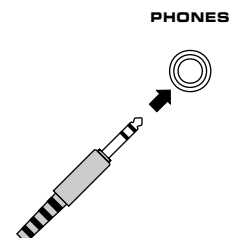

# TUNING OPERATIONS

Normally, if station signals are strong and there is no interference, quick automatic-search tuning (AUTOMATIC TUNING) is possible. However, if signals of the station you want to select are weak, you must tune to it manually (MANUAL TUNING).

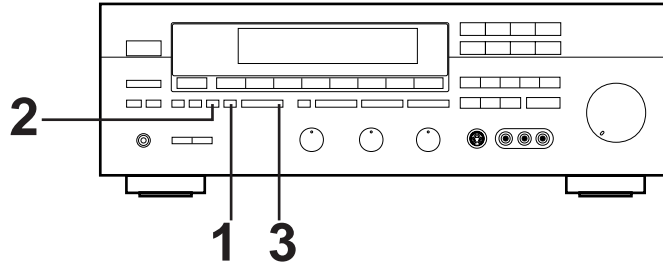

## AUTOMATIC TUNING

- 1** Select the reception band (FM or AM) while watching the display.
- 2**
- 3**

To tune to a higher frequency, press the right side once.  
To tune to a lower frequency, press the left side once.

  - \* If the station where tuning search stops is not the desired one, press again.
  - \* If the tuning search does not stop at the desired station (because the signals of the station are weak), change to the MANUAL TUNING method.

## MANUAL TUNING

- 1** Select the reception band (FM or AM) while watching the display.
- 2**
- 3** Tune to a desired station manually.

  - \* To continue tuning search, press and hold the button.

### Note

If you tune to an FM station manually, it is received in monaural mode automatically to increase the signal quality.

## Display information

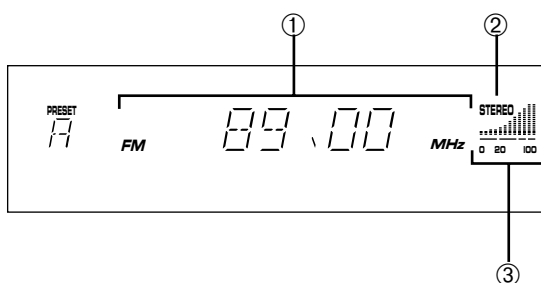

- ① Displays the band and frequency of the received station.  
\* If an RDS station is received, the frequency is then replaced by the station name. (However, if the PS data cannot be received within 5 seconds, "NO PS" flashes, and then it returns to the frequency display.) Refer to page 24 for details.
- ② Lights up when an FM stereo broadcast is received in stereo.
- ③ Indicates the signal level of the received station.

# PRESET TUNING

## MANUAL PRESET TUNING

This unit can store station frequencies (selected by tuning operation) by using the preset station buttons. With this function, you can select any desired station by only pressing the corresponding preset station button. Up to 40 stations (8 stations x 5 pages) can be stored.

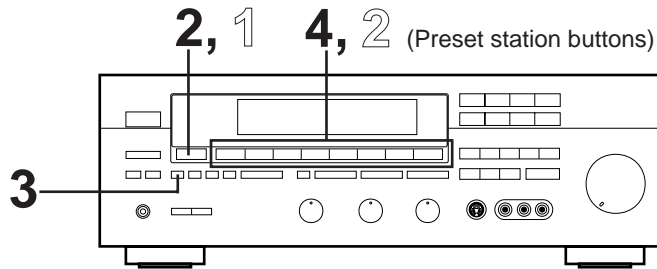

### To store stations

**1** Tune to a desired station.  
(Refer to the previous page for tuning procedure.)

**2** Select a desired page (A – E) of preset station buttons while watching the display.

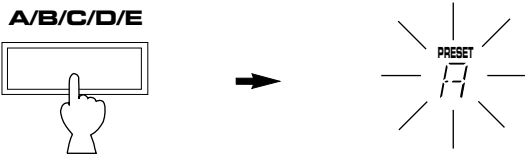

**3** **MEMORY** flashes on and off for about 5 seconds.

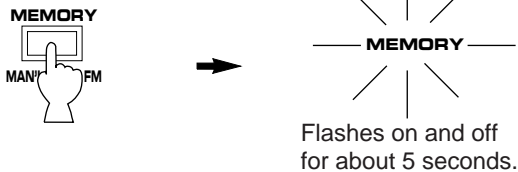

**4** Press a preset station button before “MEMORY” goes off from the display.

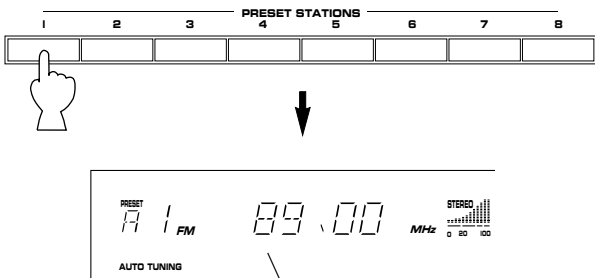

Shows the displayed station has been programmed to A1.

- \* In the same way, program other stations to A2, A3 ... A8.
- \* You can program more stations to the preset station buttons on other pages in the same way by selecting other pages in step 2.

### To recall a preset station

**1** Select the page of preset station buttons.

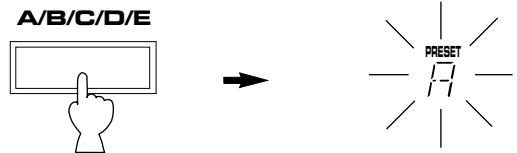

**2** Select the desired preset station button.

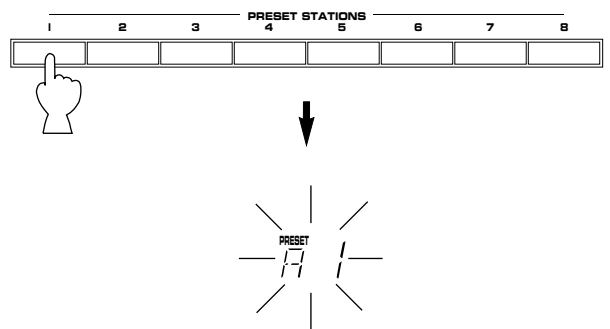

#### Notes

- A new setting can be programmed in place of the former one.
- For presets, the setting of the reception mode (stereo or monaural) is stored along with the station frequency.

#### Memory back-up

The memory back-up circuit prevents the programmed data from being lost even if the **POWER** switch is set off or the power plug is disconnected from the AC outlet or the power is cut due to temporary power failure. If, however, the power is cut for more than one week, the memory may be erased. If so, it can be re-programmed by simply following the PRESET TUNING steps.

## AUTOMATIC PRESET TUNING

You can also make use of an automatic preset tuning function for RDS stations only. By this function, this unit performs automatic tuning and stores RDS stations with strong signals sequentially. Up to 40 stations are stored automatically in the same way as in the manual preset tuning method on page 20.

\* Refer to page 23–26 for details on RDS stations.

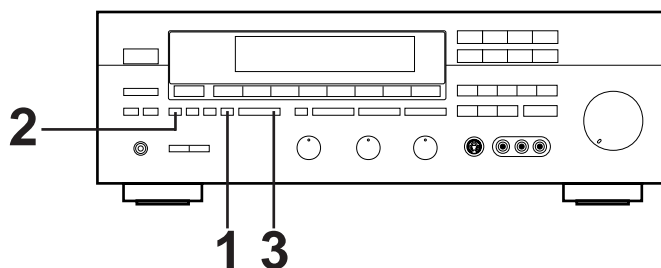

### To store stations

<b>1</b>	
<b>2</b>	<p>Press and hold for about 3 seconds.</p> <p style="text-align: center;">Flashes.</p>
<b>3</b>	<p>To tune to higher frequencies, press right side once. To tune to lower frequencies, press left side once. * If the <b>TUNING</b> button is not pressed, in a while, the automatic preset tuning begins automatically toward higher frequencies.</p> <p>The automatic preset tuning begins from the frequency currently displayed. Received stations are programmed to A1, A2 ... A8 sequentially. * If more than 8 stations are received, they are also programmed to the preset station numbers on other pages (B, C, D and E) in that order.</p>

### When the automatic preset tuning is finished

The display shows the frequency of the last preset station. Check the contents and the number of preset stations by following the procedure of the section "To recall a preset station" on page 20.

### To recall a preset station

Simply follow the procedure of the section "To recall a preset station" on page 20.

\* A recalled station is shown by the frequency or station name on the display.

### Notes

- You can replace a preset station by another FM or AM station manually by simply following the procedure of the section "To store stations" on page 20.
- The automatic preset tuning search will be performed through all RDS network frequencies until stations are stored up to E8. If the number of received stations is not enough to be stored up to E8, the search is finished automatically after searching through all frequencies.
- With this function, only RDS stations with sufficient signal strength are stored automatically. If the station you want to program is weak in signal strength, tune to it in monaural manually and program it by following the procedure of the section "To store stations" on page 20.  
\* There may be a case that this function cannot receive a station which could be received by the automatic tuning method. This is because this function receives a large volume of PI (Program Identification) data along with the station.

### If you want to store the first station received by the automatic preset tuning to a desired preset station number.

If, for example, you want to store the first received station to C5, select "C5" by using the **A/B/C/D/E** button and the preset station buttons after pressing the **MEMORY** button in step 2. Then press the **TUNING** button. The first received station is stored to C5, and next stations to C6, C7 ... sequentially. If stations are stored up to E8, the automatic preset tuning is finished automatically.

# EXCHANGING PRESET STATIONS

You can exchange the places of two preset stations with each other as shown below.

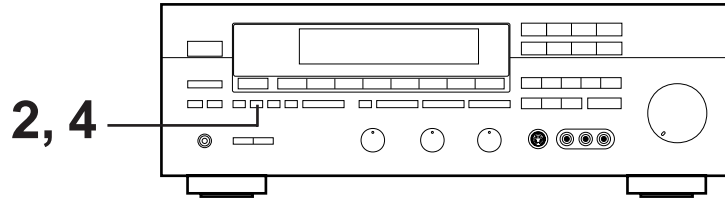

## Example)

If you want to shift the preset station on E1 to A5, and vice versa.

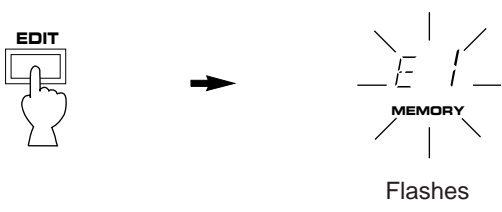
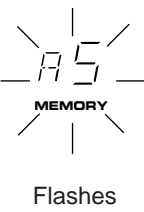
<b>1</b>	Recall the preset station on E1 (by following the method of "To recall a preset station" on page 20).
<b>2</b>	
<b>3</b>	Next, recall the preset station on A5 by following the same method with step 1. 

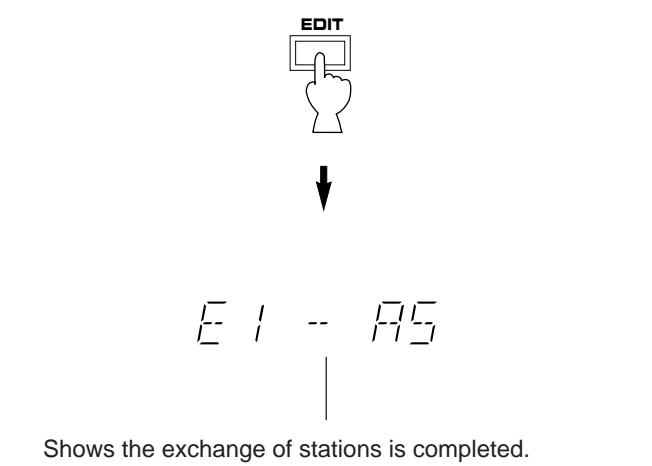
<b>4</b>	
----------	---

# RECEIVING RDS STATIONS

RDS (Radio Data System) is a data transmission system gradually being introduced by FM stations in many countries. Stations using this system transmit an inaudible stream of data in addition to the normal radio signal.

RDS data contains various information, such as AF (Alternative Frequencies for the same program station), PI (Program Identification), PS (Program Service station name), PTY (Program Type name), etc.

RDS function is carried out among the network stations.

\* This unit utilizes PI, PS and PTY to receive RDS broadcast stations.

## Displaying RDS data

This unit can be turned into the following two modes to display RDS data.

### PS (Program Service station name) mode:

Displays the name of the RDS station now being received instead of the frequency.

**BBC R3**

### PTY (Program Type name) mode:

Displays the program type of the RDS station now being received. There are 15 program types to classify RDS stations as follows.

#### **NEWS**

**News:**

Short accounts of facts, events and publicly expressed views, reportage and actuality.

#### **VARIED**

**Varied:**

Used for mainly speech-based programs usually of light-entertainment nature, not covered by above categories. Examples are: quizzes, panel games, personality interviews, comedy and satire.

#### **AFFAIRS**

**Current affairs:**

Topical program expanding or enlarging upon the news, generally in different presentation style or concept, including documentary debate, or analysis

#### **POP M**

**Pop:**

Commercial music, which would generally be considered to be of current popular appeal, often featuring in current or recent record sales charts.

#### **INFO**

**Information:**

Program whose purpose is to impart advice in the widest sense, including meteorological reports and forecasts, consumer affairs, medical help, etc.

#### **ROCK M**

**Rock:**

Contemporary modern music, usually written and performed by young musicians.

#### **SPORT**

**Sport:**

Program concerned with any aspect of sport.

#### **MOR M**

**M.O.R.:**

(Middle of the Road Music). Common term to describe music considered to be "easy-listening", as opposed to Pop, Rock or Classical. Music in this category is often but not always, vocal, and usually of short duration (<5 min.)

#### **EDUCATE**

**Education:**

Program intended primarily to educate, of which the formal element is fundamental.

#### **LIGHT M**

**Light classics:**

Classical Musical for general, rather than specialist appreciation. Examples of music in this category are instrumental music, and vocal or choral works.

#### **DRAMA**

**Drama:**

All radio plays and serials.

#### **CLASSICS**

**Serious classics:**

Performances of major orchestral works, symphonies, chamber music etc., and including Grand Opera.

#### **CULTURE**

**Culture:**

Programs concerned with any aspect of national or regional culture, including religious affairs, philosophy, social science, language, theatre, etc.

#### **OTHER M**

**Other music:**

Musical styles not fitting into any of the above categories. Particularly used for specialist music, of which Jazz, Rhythm & Blues, Folk, Country, and Reggae are examples.

#### **SCIENCE**

**Science:**

Programs about the natural sciences and technology.

## To turn the unit into the PS mode or PTY mode

Press the **FREQ/PS/PTY** button. Whenever pressed, the mode changes into the PS mode, PTY mode and returns to usual mode in turn.

\* When an RDS station is received, the display is automatically turned into the PS mode. Do not press the **FREQ/PS/PTY** button until the display is turned into the PS mode. If the button is pressed before the display mode is changed, it may occur that "NO PS" flashes on the display. This is because the unit has not received all of the RDS data on the station yet.

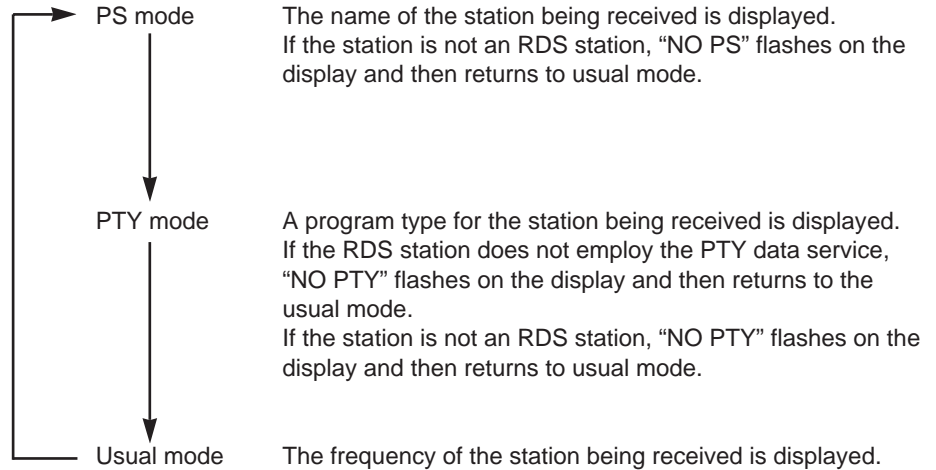

### Note

When PS or PTY data reception is not possible due to poor reception conditions, "NO PS" or "NO PTY" flashes on the display in each mode. In such a case, press the **TUNING MODE** button so that "AUTO TUNING" goes off from the display. Though the reception mode is changed to monaural by this operation, when you changes to the PS or PTY mode, PS or PTY data may be displayed.



## Calling a preset RDS station by the station name (PS SEEK)

You can call a desired RDS station stored in this unit by only inputting the name of the station in the PS mode. By this operation, this unit searches all preset stations for the station. You do not have to input a full name, even only the first letter can be used for calling. As many as 8 letters and/or numerals can be selected for inputting a name.

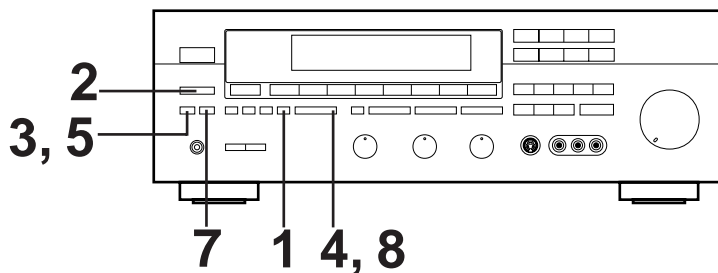

<b>1</b>		→	
<b>2</b>		→	A station name is displayed or "NO PS" flashes.
<p>* If "NO PS" flashes, proceed to the next step while flashing. If "NO PS" disappears before you proceed to the next step, press the <b>FREQ/PS/PTY</b> button again.</p>			
<b>3</b>		→	 Flashes.
<b>4</b>		→	
<p>* By pressing the <b>TUNING</b> button repeatedly or by pressing and holding it, the display will change letters and numerals in sequence.</p> <p>* If you will not input the second letter, skip to step 7.</p>			
<b>5</b>		→	 "A" will flash on the second letter or numeral position.

<b>6</b>		→	 Flashes.
<p>Repeat steps 4 and 5 for other letters and/or numerals, if necessary.</p>			
<b>7</b>		→	 Flashes.
<p>When inputting the name is finished, press the <b>ENTER</b> button.</p>			
<b>8</b>		→	Press once.
<p>The unit begins searching for the station, and it is continued until the station is found.</p>			

### You do not have to input a full name for searching for the station

You may input only the first letter of the station name. If doing so, you can skip steps 5 and 6. In step 8, the unit searches for and calls a nearest station which has the letter you input. If the station is not the desired one, press the **TUNING** button again. The unit will begin searching for another station which has the same letter.

### To cancel this function

Press the **FREQ/PS/PTY**, **SHIFT**, **ENTER**, **FM/AM** or **MEMORY** button.

### Note

This function is useful especially for calling a station with weak signals which cannot be received by the automatic tuning method. By only storing such a station, you can call it any time easily.

## Calling a preset RDS station by the program type (PTY SEEK)

By designating a program type, the unit automatically searches all preset stations for RDS stations of that program type.

\* There are 15 program types to classify RDS stations. For details, refer to page 23.

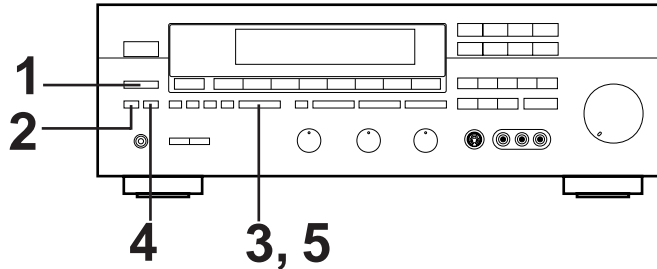

**1** Turn the unit into the PTY mode.

**PS/PTY SEEK**  
**FREQ/PS/PTY**

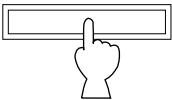

Press once or twice until a program type is displayed or "NO PTY" flashes.

\* If "NO PTY" flashes, proceed to the next step while flashing. If "NO PTY" disappears before you proceed to the next step, press the **FREQ/PS/PTY** button once or twice.

**2**

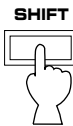

**NEWS**

The program type of the station now being received or "NEWS" flashes on the display.

**3** Select the desired program type.

**DOWN TUNING UP**

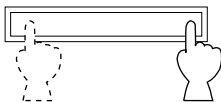

\* By pressing the **TUNING** button repeatedly or by pressing and holding it, the display will change program types in sequence.

**4** When the desired program type appears, press the **ENTER** button.

**ENTER**

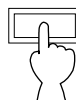

Flashes.

**5**

**DOWN TUNING UP**

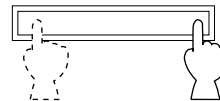

Press once.

The unit begins searching all preset stations, and calls a station of the program type if such a station is found.

\* When the right side of the **TUNING** button is pressed, the search is performed from "A1" toward higher numbers of the preset stations (A1, A2 ... A8, B1, B2, ...). If, however, "A3" is currently being called for example, the search begins from the next station "A4".

When the left side of the **TUNING** button is pressed, the search is performed in reverse order.

If the called station is not the desired one, press the **TUNING** button again to search for another station of the same program type.

### To cancel this function

Press the **FREQ/PS/PTY**, **SHIFT**, **ENTER**, **FM/AM** or **MEMORY** button.

# USING DIGITAL SOUND FIELD PROCESSOR (DSP)

This unit incorporates a sophisticated, multi-program digital sound field processor, which allows you to expand and shape the audio sound field from both the audio and video sources, for a theater-like experience in the listening/viewing room.

This digital sound field processor has 8 programs; 6 programs for digital sound field processing and 2 programs for the Dolby Pro Logic Surround sound system (**DOLBY PRO LOGIC** and **DOLBY PRO LOGIC ENHANCED**). You can create an excellent audio sound field by selecting the suitable program and adding desired adjustments. In addition, when the **DOLBY PRO LOGIC** or **DOLBY PRO LOGIC ENHANCED** program is selected, the built-in automatic input balance control functions. This presents you the best surround condition without manual adjustment.

## Front Panel

Displays your selection on the DSP or other informations.

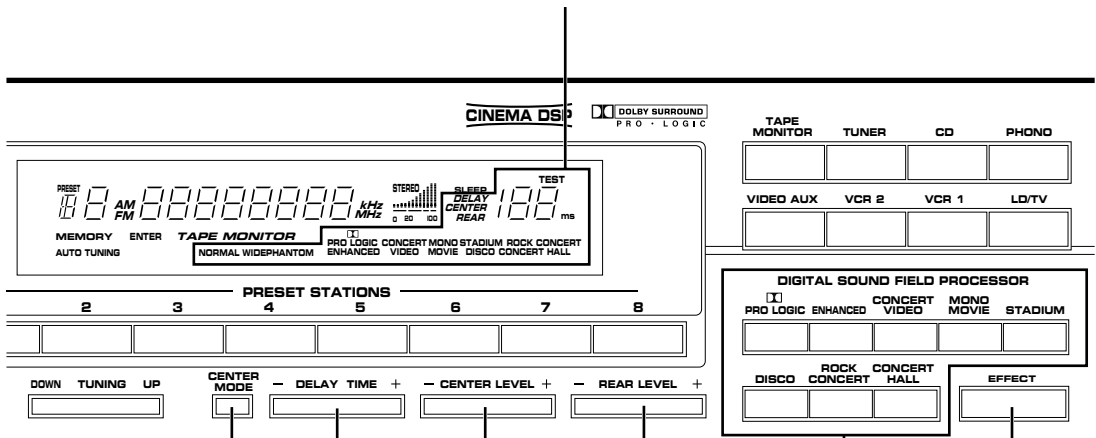

Selects the center channel output mode. (For details, refer to page 14.)

Adjusts the delay time. (For details, refer to page 30.)

Adjusts sound output level at each speaker. (For details, refer to page 29 and 30.)

Switches on/off the digital sound field processor (DSP)

Selects a digital sound field program.

## Remote Control Transmitter

Used for speaker balance adjustment (For details, refer to page 13, 14 and 15.)

Adjusts sound output level at each speaker. (For details, refer to page 29 and 30.)

Selects a digital sound field program.

Switches on/off the digital sound field processor (DSP).

Adjusts the delay time. (For details, refer to page 30.)

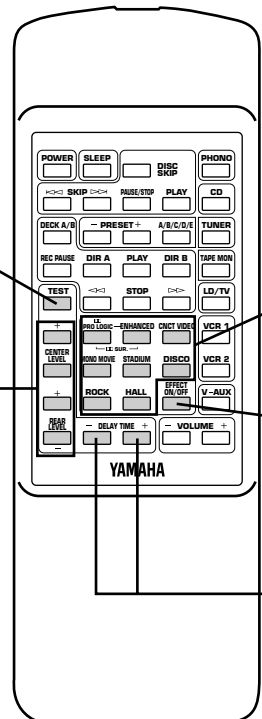

## Description of Each Sound Field Program

The following list gives brief descriptions of the sound fields produced by each of the DSP programs. Keep in mind that most of these are precise digital recreations of actual acoustic environments. The data for them was recorded at the locations described using sophisticated sound field measurement equipment.

**Note**

**The channel level balance between the left rear effect speaker and the right rear effect speaker may vary depending on the sound field you are listening to. This is due to the fact that most of these sound field recreations are actual acoustic environments.**

PROGRAM	FEATURE
<b>PRO LOGIC</b>	This program is effective for playback of sources encoded with Dolby Surround. The employment of the digital signal processing system improves crosstalk and transfers the sound source more smoothly and precisely, compared to the conventional type. A stable movie sound field is recreated.
<b>PRO LOGIC ENHANCED</b>	This program is effective for playback of sources encoded with Dolby Surround. Enhancing the "Normal" Dolby Pro Logic, the DSP technology simulates the multi-surround speaker systems of a 35 mm film theater, thus widening the surrounded-sound field with greater presence.
<b>CONCERT VIDEO</b>	This program is effective for music videos and gives excellent depth and clarity for vocals. For opera, the orchestra and stage are ideally recreated, letting you feel as if you were in an actual concert hall.
<b>MONO MOVIE</b>	This program is designed specifically to enhance mono source programs. Compared to a strictly mono setting, the sound image created in this mode is wider and slightly forward of the speaker pair, lending an immediacy to the overall sound. It is particularly effective when used with old mono movies, news broadcasts and dialog.
<b>STADIUM</b>	This program gives you long delays between direct sounds and effect sounds, and extraordinarily spacious feel of a large stadium.
<b>DISCO</b>	This program recreates the acoustic environment of a lively disco in the heart of a very lively city. The sound is dense and highly concentrated. It is also characterized by a high-energy, "immediate" sound.
<b>ROCK CONCERT</b>	This program is suitable for rock music. A big, powerful sound is reproduced lively and dynamically.
<b>CONCERT HALL</b>	In this program, the center seems deep behind the front speaker pair, creating an expansive, large hall ambience.

### Description of Dolby Pro Logic Surround

**DOLBY PRO LOGIC SURROUND:** This unit employs the Dolby Pro Logic Surround system. This system is similar to professional Dolby Stereo decoders used in movie theaters. By employing a four-channel system, the Dolby Pro Logic Surround system divides the input signals into four levels: the left and right main channels, the center channel (to characterize dialog), and the rear surround-sound channels (to characterize sound effects, background noise and other ambient noise).

Dolby Surround is encoded on the sound track of commercially available video cassettes and video discs as well. When you play a source encoded with Dolby Surround on your home video system, the Dolby Pro Logic Surround system in this unit decodes the signal and feeds the surround-sound effects. The Dolby Pro Logic Surround mode may not be always effective on video sources not encoded with Dolby Surround.

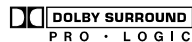

Manufactured under license from Dolby Laboratories Licensing Corporation. Additionally licensed under Canadian patent number 1,037,877. "Dolby", "Pro Logic", and the double-D symbol are trademarks of Dolby Laboratories Licensing Corporation.

## To play a source with the digital sound field processor

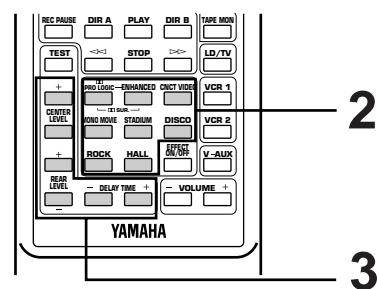
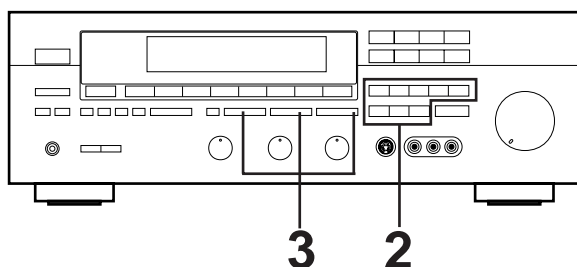

**1** Follow steps 1 – 6 shown in “**BASIC OPERATIONS**” on page 16.

**2** Select the desired program that is suitable for the source.

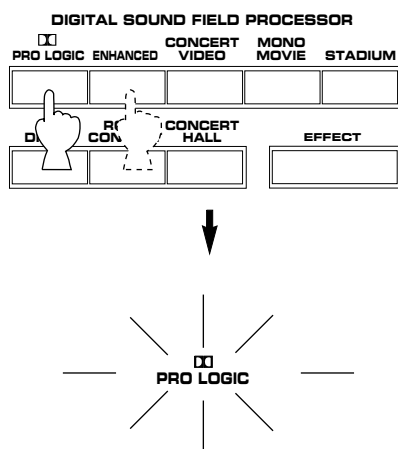

The selected program name is shown on the display.

**3** If desired, adjust the delay time and the output level of each speaker. (For details, refer to the corresponding descriptions on this page and the next page.)

### Notes

- If you prefer to cancel the DSP, press the **EFFECT** switch. The sound will be the normal 2-channel stereo without surround sound effect.
- When **CONCERT VIDEO**, **MONO MOVIE**, **STADIUM**, **DISCO**, **ROCK CONCERT** or **CONCERT HALL** is selected, no sound is heard from the center speaker.
- When a monaural sound source is played with **DOLBY PRO LOGIC** or **DOLBY PRO LOGIC ENHANCED**, no sound is heard from the front speakers and the rear speakers. Sound is heard only from the center speaker. However, if the center channel mode is in **PHANTOM**, the front speakers output the sound of the center channel.
- When this unit's Dolby Pro Logic Surround system is used, if the main-source sound is considerably altered by overadjustment of the **BASS** or **TREBLE** controls, the relationship between the center and rear channels may produce an unnatural effect.

\* The following adjustments can be done on the remote control transmitter as well as on the front panel.

## Adjustment of the CENTER LEVEL

If desired, you can adjust the sound output level of the center speaker even if the output level is already set in “**SPEAKER BALANCE ADJUSTMENT**” on page 15.

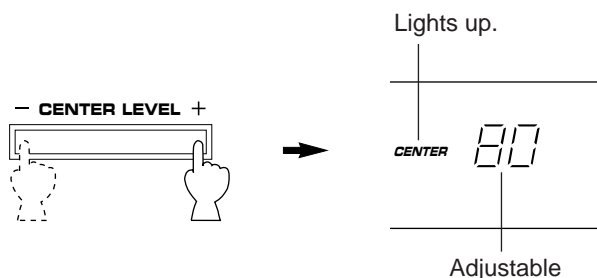

By continuously pressing “+” or “-” on the **CENTER LEVEL** control, the level value changes continuously. However, the value stops changing momentarily at the preset point (80).

- If the digital sound field program **CONCERT VIDEO**, **MONO MOVIE**, **STADIUM**, **DISCO**, **ROCK CONCERT** or **CONCERT HALL** is selected, the **CENTER LEVEL** control cannot function.
- Once the output level is adjusted, the level value will be the same in the **DOLBY PRO LOGIC** and **DOLBY PRO LOGIC ENHANCED** programs.
- If a digital sound field program is not used, the **CENTER LEVEL** control will not function.

## Adjustment of the REAR LEVEL

If desired, you can adjust the sound output level of the rear speakers even if the output level is already set in “**SPEAKER BALANCE ADJUSTMENT**” on page 15.

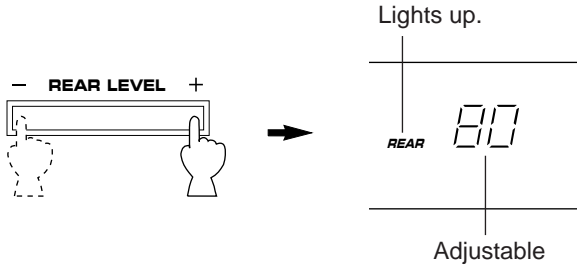

By continuously pressing “+” or “-” on the **REAR LEVEL** control, the level value changes continuously. However, the value stops changing momentarily at the preset point (80).

- Once the output level is adjusted, the level value will be the same in all the digital sound field programs.
- If **DOLBY PRO LOGIC** or a digital sound field program is not used, the **REAR LEVEL** control will not function.

## Adjustment of DELAY TIME

You can adjust the time difference between the beginning of the source sound and the beginning of the effect sound with the **DELAY TIME** control.

The **DELAY TIME** control is effective with all programs. By applying more or less delay, sound effects, background noise, and ambient noise coming at you from the rear speakers can be enhanced or subdued for extra effect.

1.  **PRO LOGIC** : from 15 to 30 milliseconds  
(Preset value: 20 milliseconds)
2.  **PRO LOGIC ENHANCED** : from 15 to 30 milliseconds  
(Preset value: 20 milliseconds)
3. **CONCERT VIDEO** : from 1 to 100 milliseconds  
(Preset value: 28 milliseconds)
4. **MONO MOVIE** : from 1 to 100 milliseconds  
(Preset value: 20 milliseconds)
5. **STADIUM** : from 1 to 50 milliseconds  
(Preset value: 45 milliseconds)
6. **DISCO** : from 1 to 100 milliseconds  
(Preset value: 14 milliseconds)
7. **ROCK CONCERT** : from 1 to 100 milliseconds  
(Preset value: 17 milliseconds)
8. **CONCERT HALL** : from 1 to 100 milliseconds  
(Preset value: 30 milliseconds)

By continuously pressing “+” or “-” on the **DELAY TIME** control, the value changes continuously. However, the value stops changing momentarily at the preset point.

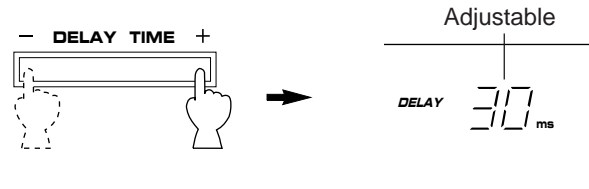

### Note

Adding too much delay will cause an unnatural effect with some sources. Experiment with the **DELAY TIME** control to create the effect that you find most suitable.

### Note

The values of the **DELAY TIME**, **CENTER LEVEL** and **REAR LEVEL** you set the last time will remain memorized even when the power of this unit is off.

However, if the power cord is kept disconnected for more than one week, these values will be automatically changed back to the original factory settings.

# SETTING THE SLEEP TIMER

If you use the SLEEP timer of this unit, you can make this unit turn off automatically. When you are going to sleep while enjoying a broadcast or other desired input source, this timer function is helpful.

## Notes

- The SLEEP timer can be controlled only with the remote control transmitter.
- The components on which the SLEEP timer is effective are the sources connected to the **SWITCHED AC OUTLET(S)** on the rear panel of this unit.

## To set the SLEEP time

**1**

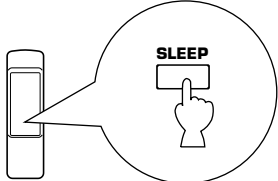

Press once or more to select the desired SLEEP time.

↓

Indicates the SLEEP time.



Flashes on and off continuously.

Whenever the **SLEEP** key is pressed, the SLEEP time will change as follows.

(Minutes)

120 → 90 → 60 → 30

The SLEEP timer is OFF.  
(The indication before the **SLEEP** key is pressed.)

After a while, the display returns to the indication before the SLEEP timer is set, and the "SLEEP" indicator stops flashing and lights up.

**2** The unit will be turned off automatically at the selected SLEEP time.

## To cancel the selected SLEEP time

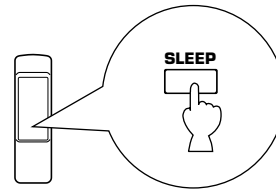

Press once or more so that the display returns to the indication before the SLEEP timer is set. ("SLEEP" will go off from the display.)

## Note

The SLEEP timer setting can also be canceled by turning off the power with the **POWER** switch or disconnecting the power plug of this unit from the AC outlet.

# REMOTE CONTROL TRANSMITTER

The remote control transmitter provided with this unit is designed to control all the most commonly used functions of the unit. If the CD player and tape deck connected to this unit are YAMAHA components, then this remote control transmitter will also control various functions of each component.

## KEY FUNCTIONS

### For Control of This Unit

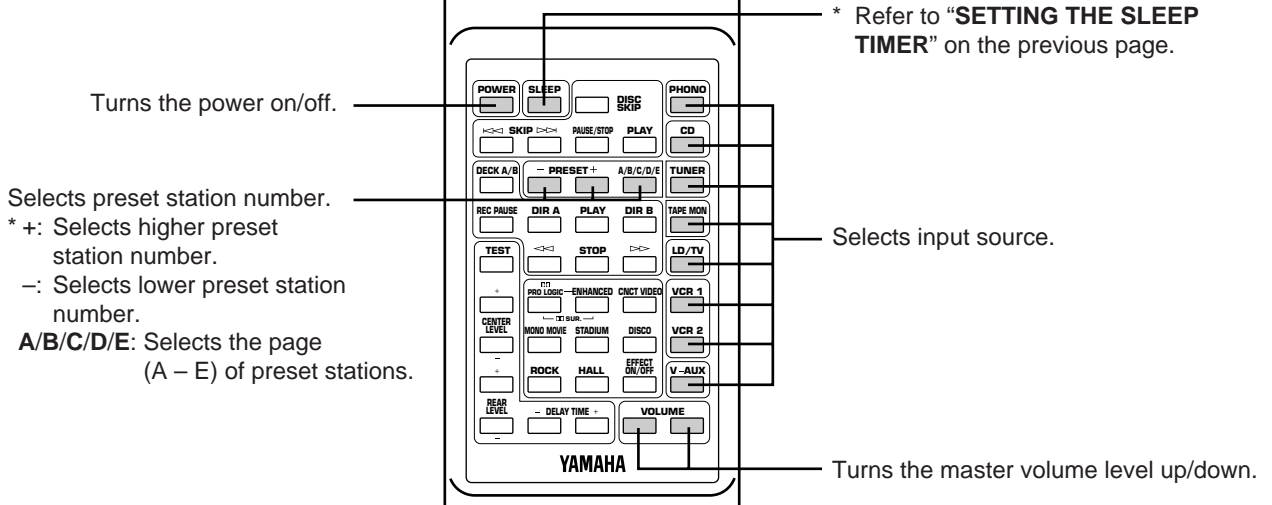

\* For the DSP control keys, refer to the page 27.

### For Other Component Control

Identify the remote control transmitter keys with your component's keys. If these keys are identical, their function will be the same. On each key function, refer to the corresponding instruction on your component's manual.

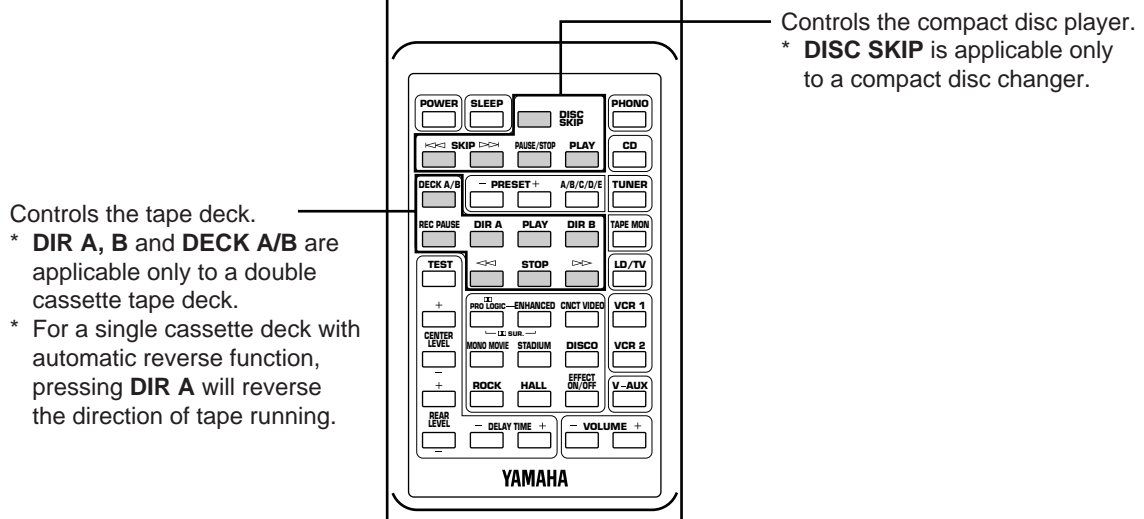



## STANDBY mode

While the power is on, pressing the **POWER** key on the remote control transmitter switches the unit to the **STANDBY** mode. (In this mode, the indicator is half illuminated.)

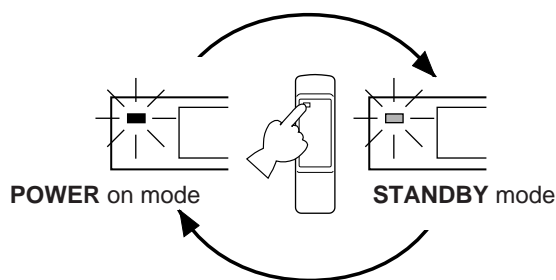

## NOTES ABOUT THE REMOTE CONTROL TRANSMITTER

### Battery installation

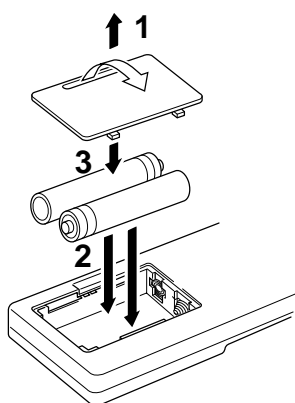

### Battery replacement

If you find that the remote control transmitter must be used closer to the main unit, the batteries are weak. Replace both batteries with new ones.

#### Notes

- Use only AA, R6, UM-3 batteries for replacement.
- Be sure the polarities are correct. (See the illustration inside the battery compartment.)
- Remove the batteries if the remote control transmitter will not be used for an extended period of time.
- If batteries leak, dispose of them immediately. Avoid touching the leaked material or letting it come in contact with clothing, etc. Clean the battery compartment thoroughly before installing new batteries.

### Remote control transmitter operation range

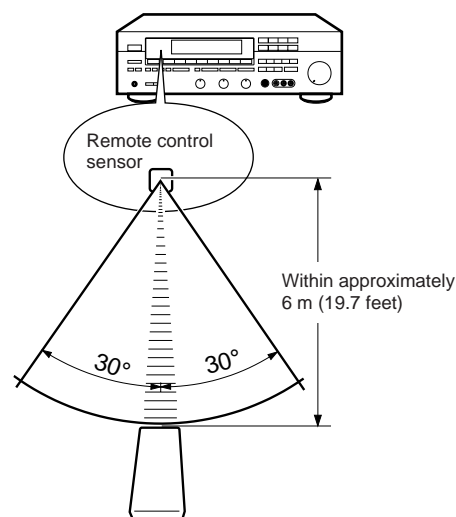

#### Notes

- There should be no large obstacles between the remote control transmitter and the main unit.
- If the remote control sensor is directly illuminated by strong lighting (especially an inverter type of fluorescent lamp etc.), it might cause the remote control transmitter not to work correctly. In this case, reposition the main unit to avoid direct lighting.

# TROUBLESHOOTING

If the unit fails to operate normally, check the following points to determine whether the fault can be corrected by the simple measures suggested. If it cannot be corrected, or if the fault is not listed in the SYMPTOM column, disconnect the power cord and contact your authorized YAMAHA dealer or service center for help.

	SYMPTOM	CAUSE	REMEDY
Amplifier	The unit fails to turn on when the POWER switch is pressed.	Power cord is not plugged in or is not completely inserted.	Firmly plug in the power cord.
	No sound or no picture.	Incorrect output cord connections.	Connect the cords properly. If the problem persists, the cords may be defective.
		Appropriate input selector is not pressed.	Press the appropriate input selector corresponding to the input source.
	The sound suddenly goes off.	The protection circuit has been activated because of short circuit etc.	Turning the unit off and then on will reset the protection circuit.
		The SLEEP timer functioned.	Do not make the SLEEP timer function.
	Only one side speaker outputs the sound.	Incorrect setting of the BALANCE control.	Adjust it to the appropriate position.
		Incorrect cord connections.	Connect the cords properly. If the problem persists, the cords may be defective.
	Sound "hums".	Incorrect cord connections.	Firmly connect the audio plugs. If the problem persists, the cords may be defective.
		No connection from the turntable to the GND terminal.	Make the GND connection between the turntable and this unit.
	The volume level is low while playing a record.	The record is being played on a turntable with an MC cartridge.	The player should be connected to the unit through the MC head amplifier.
	The volume level cannot be increased, or sound is distorted.	The power to the component connected to the REC OUT terminals of this unit is off.	Turn the power to the component on.
	No sound from the rear speakers.	The sound output level to the rear speakers is set to 0.	Turn up the sound output level with the REAR LEVEL control.
		The monaural sound source is played in DOLBY PRO LOGIC or DOLBY PRO LOGIC ENHANCED mode.	Select another program suitable for the monaural sound source.
	No sound from the center speaker.	The sound output level to the center speaker is set to 0.	Turn up the sound output level with the CENTER LEVEL control.
The center channel mode is in PHANTOM mode.		Select NORMAL or WIDE.	
Incorrect sound field program selection.		Select the appropriate program.	
No sound field program is selected.			
FM	FM stereo reception is noisy.	Because of the characteristics of FM stereo broadcasts, this is limited to cases where the transmitter is too far away or the antenna input is poor.	Check the antenna connections. Try using a multiple element FM antenna.
	There is distortion and clear reception cannot be obtained even with a good FM antenna.	There is multipath interference.	Adjust antenna placement to eliminate multipath interference.
	A desired station cannot be tuned in with Auto tuning.	The station is too weak.	Use Manual tuning mode. Use a high quality directional FM antenna.
AM	A desired station cannot be tuned in with Auto tuning.	Weak signal or loose antenna connections.	Tighten the AM loop antenna connections and rotate it for best reception.
			Use Manual tuning mode.
	There are continuous crackling and hissing noises.	Noises will result from lightning, fluorescent lamps, motors, thermostats and other electrical equipment.	Use an outdoor antenna and a ground wire. This will help somewhat but it is difficult to eliminate all noise.
Remote control transmitter	The remote control transmitter does not work.	Direct sunlight or lighting (of an inverter type of fluorescent lamp etc.) is striking the remote control sensor of the main unit.	Change the position of the main unit.
		The batteries of this remote control transmitter are too weak.	Replace the batteries with new ones.
Others	The sound is degraded when monitoring is performed by using the headphones connected to the compact disc player or cassette deck which are connected with this unit.	The power to this unit is off.	Turn the power to this unit on.

# SPECIFICATIONS

## AUDIO SECTION

Minimum RMS Output Power per Channel  
Front L, R  
8 ohms, 20 Hz to 20 kHz, 0.04% THD  
.....70W+70W  
Center  
8 ohms, 1 kHz, 0.07% THD .....70W  
Rear L, R  
8 ohms, 1 kHz, 0.3% THD .....20W+20W  
Dynamic Power per Channel  
(by IHF Dynamic Headroom measuring  
method)  
8/6/4/2 ohms .....95/120/150/170W  
DIN Standard Output Power per Channel  
4 ohms, 1 kHz, 0.7% THD  
[Europe model only] .....100W  
IEC Power  
8 ohms, 1 kHz, 0.1% THD  
[Europe model only] .....78W  
Power Band Width  
8 ohms, 30W, 0.08% THD  
.....10 Hz to 50 kHz  
Damping Factor (SPEAKERS A)  
8 ohms, 20 Hz to 20 kHz .....80 or more  
Input Sensitivity/Impedance  
PHONO MM .....2.5 mV/47 k-ohms  
CD/TAPE/LD-TV/VCR .....150 mV/47 k-ohms  
Maximum Input Signal (1 kHz, 0.5% THD)  
PHONO MM .....115 mV  
CD/TAPE/LD-TV/VCR (EFFECT ON)  
.....2.2V  
Output Level/Impedance  
REC OUT .....150 mV/1.0 k-ohms  
PRE OUT .....2.2V/1.2 k-ohms  
LPF (EFFECT OFF) .....3.5V/1.5 k-ohms  
Headphone Jack Rated Output/Impedance  
Output Level (8 ohms, 1 kHz, 150 mV)  
.....0.5V  
Impedance .....390 ohms  
Frequency Response (20 Hz to 20 kHz)  
CD/TAPE/LD-TV/VCR (FRONT L/R)  
.....0±0.5 dB  
RIAA Equalization Deviation  
PHONO MM .....0±0.5 dB  
Total Harmonic Distortion  
PHONO MM to REC OUT  
20 Hz to 20 kHz, 1V .....0.02% or less  
CD/TAPE/LD-TV/VCR to SP OUT  
FRONT L/R (EFFECT OFF)  
20 Hz to 20 kHz, 30W/8 ohms  
.....0.02% or less  
REAR L/R  
1 kHz, 10W/8 ohms .....0.3% or less

Signal-to-Noise Ratio (IHF-A Network)  
PHONO MM to REC OUT (5 mV Input  
Shorted) .....82 dB or more  
CD/TAPE/LD-TV/VCR to SP OUT (Input  
Shorted, EFFECT OFF) .....99 dB or more  
Residual Noise (IHF-A Network)  
FRONT L/R .....140 µV or less  
Channel Separation  
(Vol. -30 dB, EFFECT OFF)  
PHONO MM  
(Input Shorted, 1 kHz/10 kHz)  
.....60 dB or more/50 dB or more  
CD/TAPE/LD-TV/VCR  
(Input 5.1 k-ohms Shorted, 1 kHz/10 kHz)  
.....60 dB or more/44 dB or more  
Tone Control Characteristics  
BASS: Boost/cut .....±10 dB (50 Hz)  
Turnover Frequency .....(350 Hz)  
TREBLE: Boost/cut .....±10 dB (20 kHz)  
Turnover Frequency .....(3.5 kHz)  
Filter Characteristics  
LPF (fc=200 Hz) .....6 dB/oct  
Gain Tracking Error (0 to -60 dB)  
.....3 dB or less

## VIDEO SECTION

Video Signal Level .....1 Vp-p/75 ohms  
S-Video Signal Level  
Y .....1 Vp-p/75 ohms  
C .....0.286 Vp-p/75 ohms  
Maximum Input Level .....1.5 Vp-p or more  
Signal-to-Noise Ratio .....50 dB or more  
Monitor Out Frequency Response  
.....5 Hz to 10 MHz, -3 dB

## FM SECTION

Tuning Range .....87.5 to 108.0 MHz  
Usable Sensitivity (75 ohms)  
DIN, Mono (S/N 26 dB) .....0.9 µV  
DIN, Stereo (S/N 46 dB) .....24 µV  
Image Response Ratio .....80 dB  
IF Response Ratio .....80 dB  
Spurious Response Ratio .....70 dB  
AM Suppression Ratio .....55 dB  
Capture Ratio .....1.5 dB  
Selectivity (two signals, 40 kHz Dev.)  
.....70 dB  
Signal-to-Noise Ratio  
(DIN-Weighted, 40 kHz Dev.)  
Mono/Stereo .....74 dB/69 dB  
Harmonic Distortion (1 kHz, 40 kHz Dev.)  
Mono/Stereo .....0.1/0.2%

Stereo Separation (1 kHz, 40 kHz Dev.)  
.....50 dB  
Frequency Response  
20 Hz to 15 kHz .....0 ±1.5 dB

## AM SECTION

Tuning Range .....531 to 1,611 kHz  
Usable Sensitivity .....100 µV/m  
Selectivity .....32 dB  
Signal-to-Noise Ratio .....50 dB  
Image Response Ratio .....40 dB  
Spurious Response Ratio .....50 dB  
Harmonic Distortion (1 kHz) .....0.3%

## AUDIO SECTION

Output Level/Impedance  
FM (1 kHz, 40 kHz Dev.)  
.....400 mV/2.2 k-ohms  
AM (30% mod., 1 kHz)  
.....150 mV/2.2 k-ohms

## GENERAL

Power Supply  
[U.K. model] .....AC 240V, 50 Hz  
[Europe model] .....AC 230V, 50 Hz  
Power Consumption .....300W  
AC Outlets  
2 SWITCHED OUTLETS  
[Europe model] .....120W max. total  
1 SWITCHED OUTLET  
[U.K. model] .....120W max. total  
Dimensions (W x H x D)  
.....435 x 146 x 386 mm  
(17-1/8" x 5-3/4" x 15-3/16")  
Weight .....10 kg (22 lbs. 0 oz.)  
Accessories .....AM loop antenna  
Indoor FM antenna  
Remote control transmitter  
Batteries

Specifications are subject to change without notice.

# YAMAHA

---

YAMAHA ELECTRONICS CORPORATION, USA 6660 ORANGETHORPE AVE., BUENA PARK, CALIF. 90620, U.S.A.  
YAMAHA CANADA MUSIC LTD. 135 MILNER AVE., SCARBOROUGH, ONTARIO M1S 3R1, CANADA  
YAMAHA ELECTRONIK EUROPA G.m.b.H. SIEMENSSTR. 22-34, D-25462 RELLINGEN BEI HAMBURG, F.R. OF GERMANY  
YAMAHA ELECTRONIQUE FRANCE S.A. RUE AMBROISE CROIZAT BP70 CROISSY-BEAUBOURG 77312 MARNE-LA-VALLEE CEDEX02, FRANCE  
YAMAHA ELECTRONICS (UK) LTD. YAMAHA HOUSE, 200 RICKMANSWORTH ROAD WATFORD, HERTS WD1 7JS, ENGLAND  
YAMAHA SCANDINAVIA A.B. J A WETTERGRENS GATA 1, BOX 30053, 400 43 VÄSTRA FRÖLUNDA, SWEDEN  
YAMAHA MUSIC AUSTRALIA PTY, LTD. 17-33 MARKET ST., SOUTH MELBOURNE, 3205 VIC., AUSTRALIA

YAMAHA CORPORATION

VT04810