

YAMAHA MX-55

Natural Sound 2-/4-Channel Dual-Mode Power Amplifier

Selectable 2-/4-Channel Operation

High Power Output: 106W into 8 Ohms (2-Channel), 52W into 8 ohms (4-Channel)

Adjustable Front/Rear Speaker Level (4-Channel)

Thank you for purchasing the YAMAHA MX-55 power amplifier.

CENTER

CONTENTS

Safety Instructions	1
Controls and Their Functions	3
Connections	5
Troubleshooting	10
Specifications	Back cover

OWNER'S MANUAL



IMPORTANT!

Please make a note of the serial number of this unit in the space indicated below.

Model: **MX-55**

Serial no:

The serial number can be found on the rear panel of this unit.
Keep this Owner's Manual in a safe place for future reference.

SAFETY INSTRUCTIONS

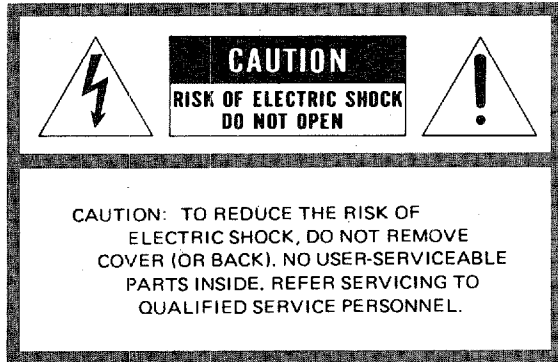

• Explanation of Graphical Symbols



The lightning flash with arrowhead symbol, within an equilateral triangle, is intended to alert you to the presence of uninsulated "dangerous voltage" within the product's enclosure that may be of sufficient magnitude to constitute a risk of electric shock to persons.

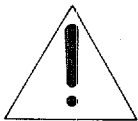

The exclamation point within an equilateral triangle is intended to alert you to the presence of important operating and maintenance (servicing) instructions in the literature accompanying the appliance.

WARNING

To reduce the risk of fire or electric shock, do not expose this appliance to rain or moisture.

- 1** Read Instructions – All the safety and operating instructions should be read before the appliance is operated.
- 2** Retain Instructions – The safety and operating instructions should be retained for future reference.
- 3** Heed Warnings – All warnings on the appliance and in the operating instructions should be adhered to.
- 4** Follow Instructions – All operating and other instructions should be followed.
- 5** Water and Moisture – The appliance should not be used near water – for example, near a bathtub, washbowl, kitchen sink, laundry tub, in a wet basement, or near a swimming pool, etc.
- 6** Carts and Stands – The appliance should be used only with a cart or stand that is recommended by the manufacturer.
- 6A** An appliance and cart combination should be moved with care. Quick stops, excessive force, and uneven surfaces may cause the appliance and cart combination to overturn.
- 7** Wall or Ceiling Mounting – The appliance should be mounted to a wall or ceiling only as recommended by the manufacturer.



- 8** Ventilation – The appliance should be situated so that its location or position does not interfere with its proper ventilation. For example, the appliance should not be situated on a bed, sofa, rug, or similar surface, that may block the ventilation openings; or cabinet that may impede the flow of air through the ventilation openings.
- 9** Heat – The appliance should be situated away from heat sources such as radiators, stoves, or other appliances that produce heat.
- 10** Power Sources – The appliance should be connected to a power supply only of the type described in the operating instructions or as marked on the appliance.
- 11** Power-Cord Protection – Power-supply cords should be routed so that they are not likely to be walked on or pinched by items placed upon or against them, paying particular attention to cords at plugs, convenience receptacles, and the point where they exit from the appliance.
- 12** Cleaning – The appliance should be cleaned only as recommended by the manufacturer.
- 13** Nonuse Periods – The power cord of the appliance should be unplugged from the outlet when left unused for a long period of time.
- 14** Object and Liquid Entry – Care should be taken so that objects do not fall into and liquids are not spilled into the inside of the appliance.

CAUTION: READ THIS BEFORE OPERATING YOUR MX-55

15 Damage Requiring Service – The appliance should be serviced by qualified service personnel when:

- A.** The power-supply cord or the plug has been damaged; or
- B.** Objects have fallen, or liquid has been spilled into the appliance; or
- C.** The appliance has been exposed to rain; or
- D.** The appliance does not appear to operate normally or exhibits a marked change in performance; or
- E.** The appliance has been dropped, or the cabinet damaged.

16 Servicing – The user should not attempt to service the appliance beyond those means described in the operating instructions. All other servicing should be referred to qualified service personnel.

17 Power Lines – An outdoor antenna should be located away from power lines.

18 Grounding or Polarization – The precautions that should be taken so that the grounding or polarization of an appliance is not defeated.

1 To ensure the finest performance, please read this manual carefully. Keep it in a safe place for future reference.

2 Install your unit in a cool, dry, clean place – away from windows, heat sources, and too much vibration, dust, moisture or cold. Avoid sources of hum (transformers, motors). To prevent fire or electrical shock, do not expose to rain and water.

3 Do not operate the amplifier upside-down. It may overheat, possibly causing damage.

4 Never open the cabinet. If a foreign object drops into the set, contact your dealer.

5 Do not place records or other objects on top of the amplifier; this will block the ventilation holes, cause the internal temperature to rise and may result in a failure.

6 Do not use force on switches, knobs or cords. When moving the set, first turn the unit off. Then gently disconnect the power plug and the cords connecting to other equipment. Never pull the cord itself.

7 Do not attempt to clean the unit with chemical solvents; this might damage the finish. Use a clean, dry cloth.

8 Be sure to read the "Troubleshooting" section on common operating errors before concluding that your unit is faulty.

9 Do not connect audio equipment to the AC outlets on the rear panel if that equipment requires more power than the outlets are rated to provide.

CONTROLS AND THEIR FUNCTIONS

FRONT PANEL

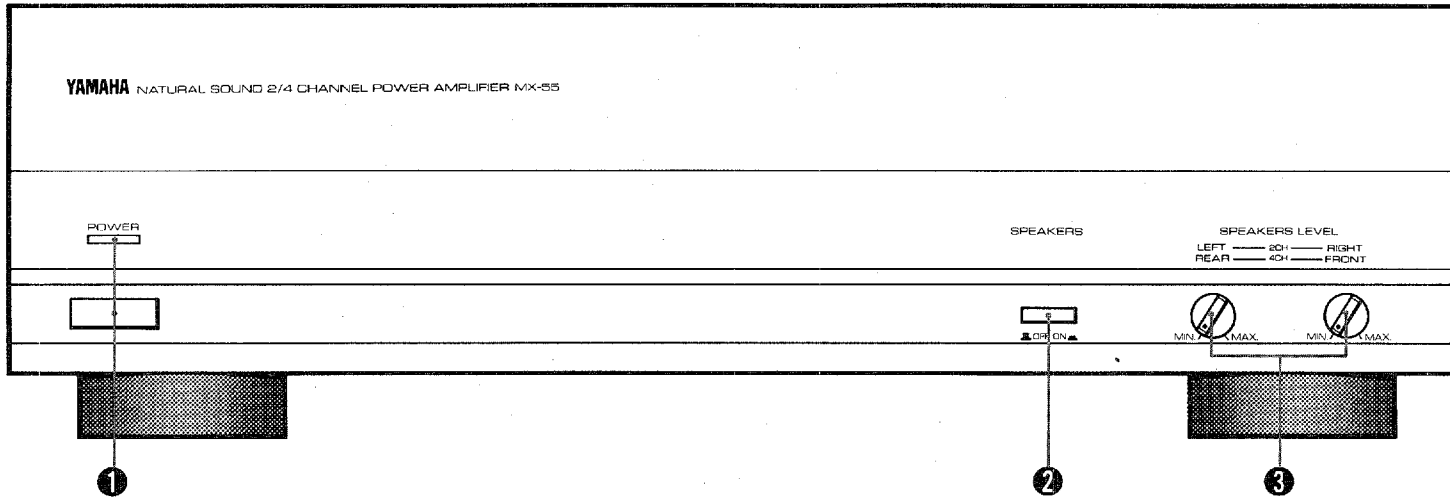

REAR PANEL

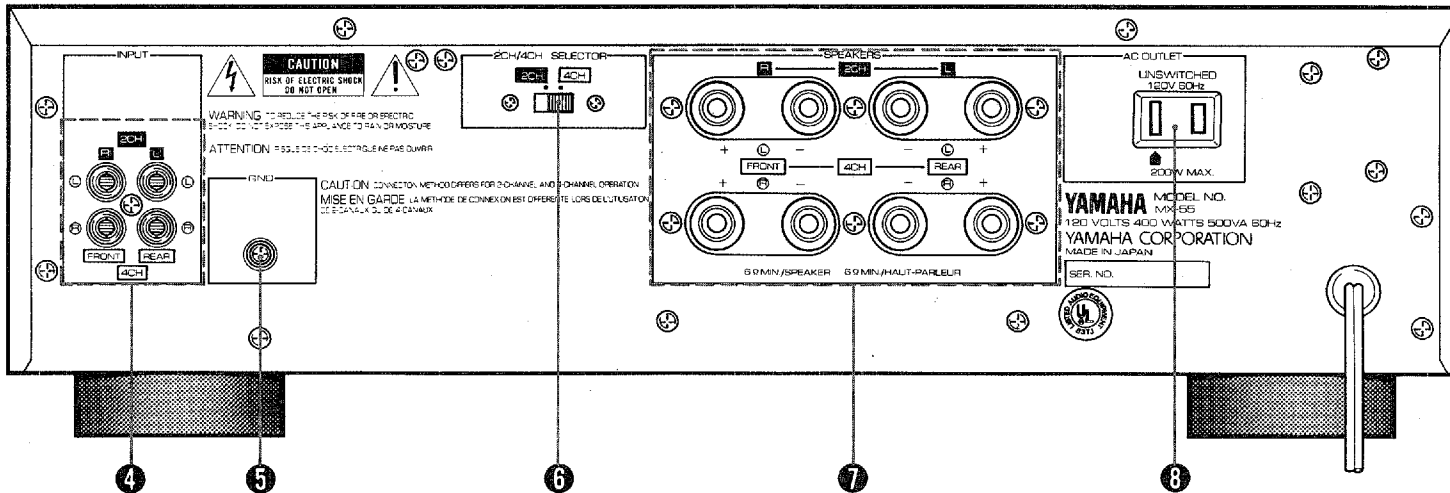

① POWER switch/indicator (POWER)

Press this switch to switch ON the power. The indicator above it will illuminate while the power is ON.

Press the switch again to switch OFF the power. Note the following cautions.

- Before switching ON the power, be sure to set the volume control(s) of other components (such as the control amplifier, surround-sound processor, etc.) to the lowest setting in order to avoid damage to the speakers.
- The speaker-protection circuit functions to mute speaker sound reproduction for a few seconds after the power is switched ON.

② SPEAKERS switch (SPEAKERS ON/OFF)

Sound is reproduced through the speaker systems connected to this unit when this switch is pressed inward. No sound is reproduced when the switch is pressed again to release it outward.

③ SPEAKERS LEVEL controls (SPEAKER LEVEL)

These controls are used for adjustment of the volume level of the sound reproduced through the speaker systems connected to this unit. Turning a control clockwise increases the volume level from the speaker system(s) corresponding to that control.

Note that the function of these controls differs depending upon whether the unit is being used for 2-channel operation or 4-channel operation, as follows.

(1) Two-channel operation:

The control at the right is used to adjust the volume of sound from the right speaker system, and the control at the left is for the left speaker system.

(2) Four-channel operation:

The control at the right is used to adjust the volume of sound from the front speaker systems, and the control at the left is for the rear speaker systems.

- Note that, for four-channel operation, these controls cannot be used for adjustment of the left/right balance of the sound. If such an adjustment is necessary, it should be made by using the control on the control amplifier.

- Normally, during 4-CHANNEL operation, these controls should be set to the fully clockwise (MAX) position, and then the left control should be turned counterclockwise if it is necessary to make an adjustment of the front/rear balance of the sound.
- To make an overall adjustment of the level of the sound, do so by using the control on the control amplifier.

④ INPUT terminals

These terminals are for connections from a control amplifier, surround-sound processor, etc. Note that the connections differ depending upon whether this unit is to be used for two-channel operation or four-channel operation.

- Refer to the section "CONNECTIONS" for detailed information.

⑤ Ground (GND) terminal knob

Make a connection between this terminal and the same terminal of the control amplifier if making the connection results in less hum or other noise.

⑥ 2-/4-CHANNEL selector (2CH/4CH SELECTOR)

Set this selector to the "2CH" position if the unit is to be used for two-channel operation, or to the "4CH" position for four-channel operation.

⑦ SPEAKERS terminals

These terminals are for connections to the speaker systems. Just as for the INPUT terminals, note that the connections differ depending upon whether this unit is to be used for two-channel operation or four-channel operation.

- Refer to the section "CONNECTIONS" for detailed information.

⑧ UNSWITCHED AC outlet

This unswitched AC outlet can be used for connection of the power cord from another audio component. Note that the power to that component is not affected by the ON or OFF setting of the POWER switch of this unit.

Note: The component connected here should have a rating of no more than 200W.

CONNECTIONS

- Before attempting to make any connections to or from this unit, be sure to first switch OFF the power to this unit and to any other components to which connections are being made.

- Note that the arrangement of connections differs depending upon whether this unit is to be used for two-channel operation or four-channel operation.

■ CONNECTIONS FOR 4-CHANNEL OPERATION

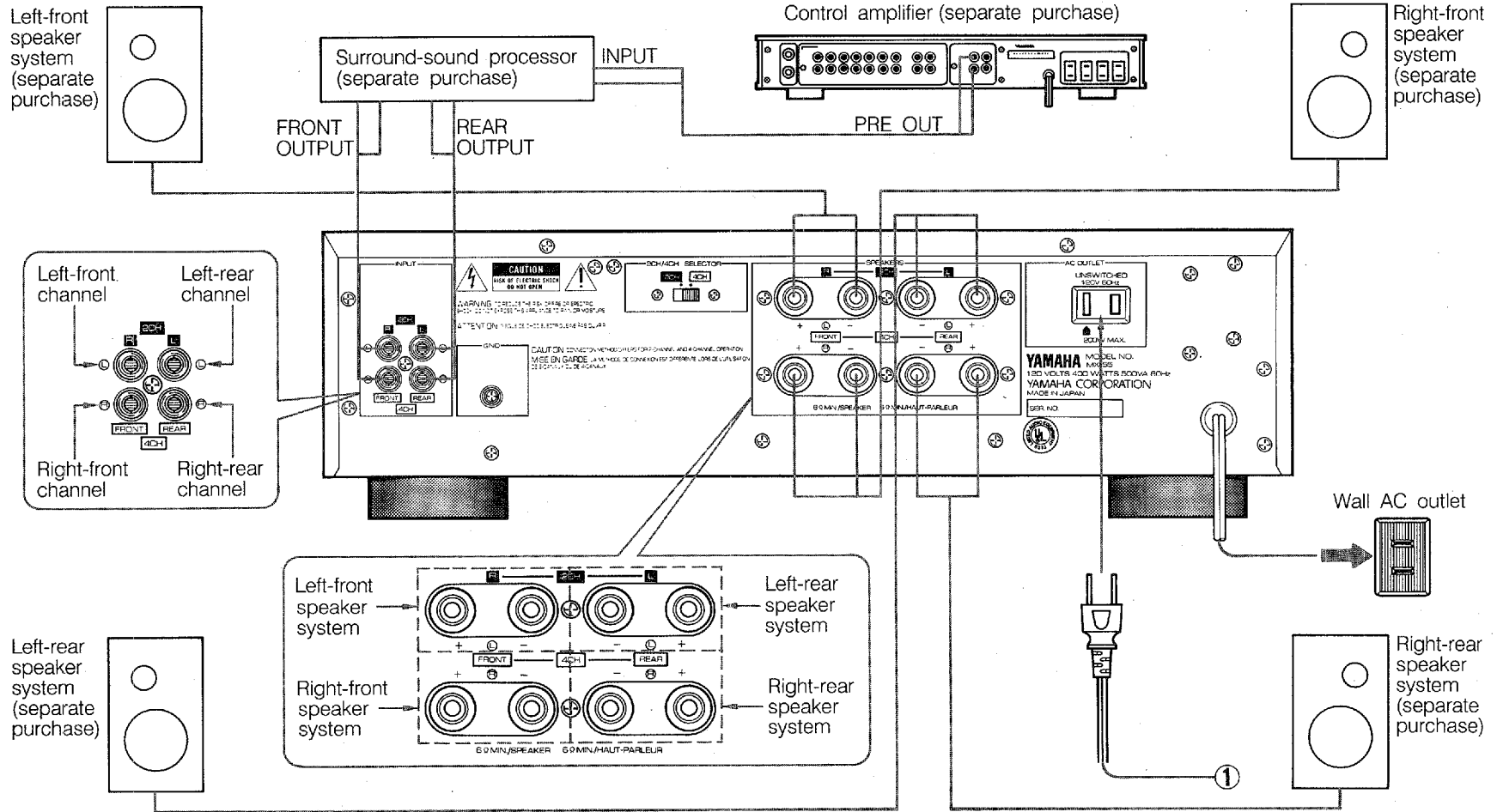

-
1. Set the 2-/4-CHANNEL selector to the "4CH" position.
 2. Make connections from the "PRE OUT" terminals of a control amplifier to the "INPUT" terminals of a surround-sound processor, and then from the "FRONT OUTPUT" terminals of the surround-sound processor to the left pair of "INPUT" terminals of this unit, and from the "REAR OUTPUT" terminals of the surround-sound processor to the right pair of "INPUT" terminals of this unit, as illustrated on the previous page.
 3. Then make the connections from this unit to the speaker systems.
 - Make connections from the upper left pair of speaker terminals on this unit to the left front speaker system.
 - Make connections from the lower left pair of speaker terminals on this unit to the right front speaker system.
 - Make connections from the upper right pair of speaker terminals on this unit to the left rear speaker system.
 - Make connections from the lower right pair of speaker terminals on this unit to the right rear speaker system.
- * Be sure all connections are to the correct respective positive ("+") and negative ("-") terminals of the speaker systems.
- * Concerning the connections of other components, refer to the Owner's Manual for each component.

① **AC outlet**

A maximum of 200W can be supplied to another component connected here. Note that this outlet is "unswitched" (i.e., is not affected by the POWER switch of this unit).

■ CONNECTIONS FOR 2-CHANNEL OPERATION

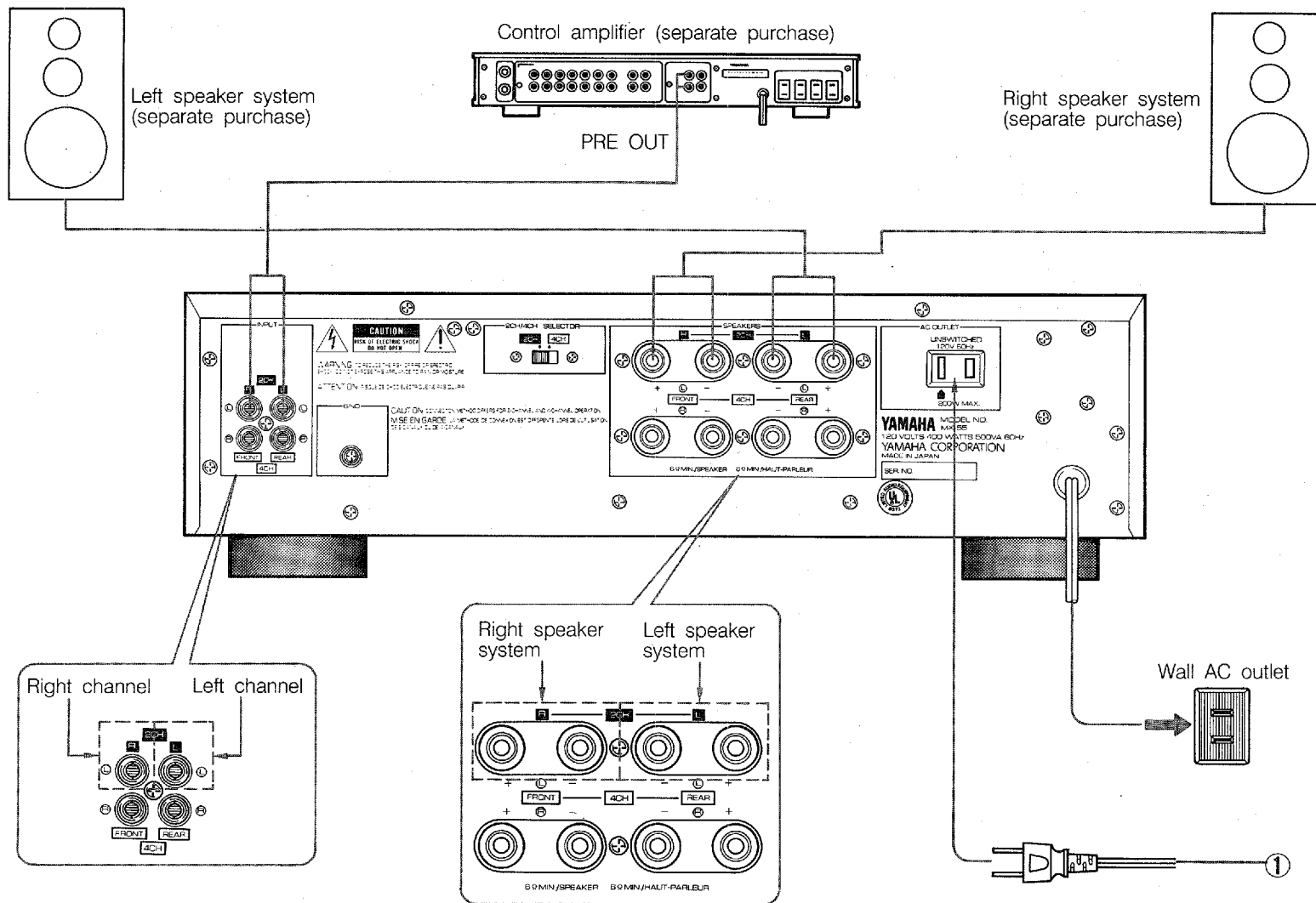

-
1. Set the 2-/4-CHANNEL selector to the "2CH" position.
 2. Make connections from the "PRE OUT" terminals of a control amplifier to the upper pair of "INPUT" terminals of this unit, as illustrated on the previous page.
 3. Then make the connections from this unit to the speaker systems.
 - * Be sure all connections are to the correct respective positive ("+") and negative ("-") terminals of the speaker systems.
 - * Concerning the connections of other components, refer to the Owner's Manual for each component.

① **AC outlet**

A maximum of 200W can be supplied to another component connected here. Note that this outlet is "unswitched" (i.e., is not affected by the POWER switch of this unit).

■ SPEAKER CONNECTIONS

1. Strip off about 10 mm (3/8 in.) of the insulation (leaving only the core wire) from the end of each speaker connection wire to be connected to this unit.
2. Unscrew the knob (for the SPEAKER connection terminal to which the speaker connection wire is to be connected) until the wire can be inserted into the hole at the top of the rear part of the knob. Each speaker connection wire should be inserted securely, taking care that it does not contact any other terminal. Then turn the knob to tighten the knob securely.

Red: positive (+)
Black: negative (-)

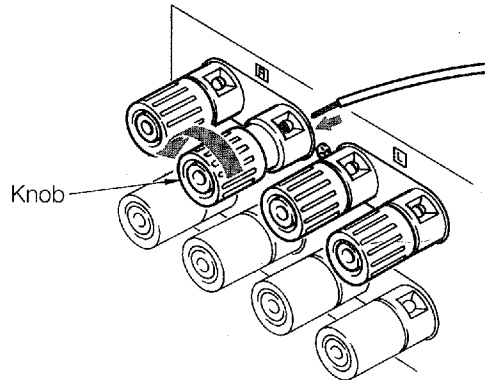

The speaker connection wires should be no longer than necessary.

- * Be sure that the connection wires are each connected to the speaker system that corresponds to that terminal.
- * Note that there are two terminals (one positive and one negative) for each speaker system cabinet. The red terminal must be connected to the positive (+) terminal on the speaker system, and the black terminal to the negative (-) terminal on the speaker system.
If connections are not correct, the sound reproduced from the speaker systems will seem unnatural, with insufficient stereo effect, sound will seem localized between the speaker systems, and low-range sound will be unsatisfactory.
- * Be sure that the impedance of the speaker systems is within the specified range for this unit.

TROUBLESHOOTING

If the unit fails to operate normally, check the following points to determine whether the problem can be corrected by the simple measures suggested. If it cannot, or if the problem is not listed in the SYMPTOM column, disconnect the unit's power cord and contact your dealer or service center for assistance.

Symptom	Probable Cause	Remedy
The power is not switched ON when the POWER switch is pressed.	The power cord plug is not connected securely to the wall power outlet.	Connect it securely.
No sound is heard.	The SPEAKERS switch is released outward to the "OFF" position.	Press it inward to the "ON" position.
	The SPEAKER LEVEL controls are set all the way to the "MIN" position.	Turn them clockwise.
	The connection cords are not connected securely to the INPUT jacks.	Connect them securely.
	The speaker systems are not properly connected to this unit.	Connect them correctly.
No sound is heard from the front and/or rear speaker systems, or from the left and/or right speaker systems.	The speaker systems are not properly connected to this unit.	Connect them correctly.
	One of the SPEAKER LEVEL controls is set to the fully counterclockwise position.	Turn that SPEAKER LEVEL control clockwise.
	The 2-/4-CHANNEL selector is not set to the correct position.	Set it correctly.
The balance between the left and right cannot be adjusted during four-channel operation.	During four-channel operation, the left/right balance adjustment cannot be made by using the controls on this unit.	Make the adjustment by using the controls on the control amplifier.
The acoustic "image" is unstable, characterized by unnatural sound and insufficient low-range tonal quality.	The positive (+) and negative (-) polarities (of this unit and the speaker systems) are not matched.	Reconnect the speaker systems to this unit so that the polarities are aligned.
Hum noise is heard from the speakers.	The connection cords are not connected securely to the INPUT jacks.	Connect them securely.

SPECIFICATIONS

Rated outputs

Minimum RMS output power per channel	
Two-channel operation (20 Hz – 20 kHz)	
0.003% THD, 8 ohms	70W
0.003% THD, 6 ohms	80W
Four-channel operation (20 Hz – 20 kHz)	
0.005% THD, 8 ohms	35W
0.005% THD, 6 ohms	40W

Dynamic Power per channel

Two-channel operation	
(1 kHz, 8 ohms/6 ohms)	106W/126W
Four-channel operation	
(1 kHz, 8 ohms/6 ohms)	52W/62W

Dynamic Headroom

Two-channel operation	
(8 ohms/6 ohms)	1.80 dB/1.97 dB
Four-channel operation	
(8 ohms/6 ohms)	1.72 dB/1.90 dB

Power Band Width

Four-channel operation	
(0.03% THD, 17.5W/8 ohms)	5 Hz – 100 kHz

Damping Factor (1 kHz, 8 ohms) 170

Input Sensitivity/Input Impedance

Two-channel operation	1.0V/20 k-ohms
Four-channel operation	0.7V/20 k-ohms

Frequency Response 20 Hz – 20 kHz, +0/-0.3 dB

Total Harmonic Distortion

Two-channel operation (1 kHz, 35W/8 ohms)	0.002%
Four-channel operation (1 kHz, 17.5W/8 ohms)	0.003%

Signal-to-Noise Ratio (IHF-A-Network, Input short-circuit)

Two-channel operation	122 dB
Four-channel operation	119 dB

Residual Noise (IHF-A-Network) 16 μ V

Channel Separation

(1 kHz, vol. -30 dB, Input shorted)

Two-channel operation	110 dB
Four-channel operation	90 dB

Power Supply AC 120V, 60 Hz

Rated Power Consumption 400W 500 VA

AC Outlet (unswitched) 200W max.

Dimensions (W x H x D) 435 x 129 x 379 mm
(17-1/8" x 5-1/16" x 14-15/16")

Weight 9.5 kg (20 lbs. 14 oz.)

* Please note that the design and all specifications are subject to change without notice.