

POWER AMPLIFIER

MA2120

Setup Guide
Installationsanleitung
Guide de configuration
Guía de configuración
Guida alla configurazione
Guia de Configuração
Руководство по настройке
設置指南
セットアップガイド

EN
DE
FR
ES
PT
IT
RU
ZH
JA

English

Deutsch

Français

Español

Português

Italiano

Русский

中文

日本語

Contents

Connections 3

Attaching Euroblock Plugs.....	3
Connecting Speaker Cables.....	3
Connecting Microphones or External Devices	4
Connecting Microphones	4
Connecting External Devices	4
Using the Mono Sum Input.....	4
Connecting the PA2120 Power Amplifier.....	5
Connecting a Control Panel.....	6
Functions Operated Via the Control Panel	6
Using the [REMOTE] Connector (Euroblock 3-pin)	7

Setup Mode (Advanced settings) 8

Setup Mode Operation Procedure.....	8
Indication of Parameter Settings.....	8
Operation Procedure	9
Turning Off the Microphone Input High-Pass Filter	9
Applying Compressor to the Microphone Input	9
Applying EQ (equalizer) to the Input Signal	10
Applying Echo/Reverb to the Input Signal.....	11
Adjusting the Reverb Mix Level	11
Adjusting the Ducker Sensitivity	12
Regulating BGM Volume (Leveler)	12
Setting the Chime Volume	13
Adjusting the Line Out Volume by Using the [VOLUME] Knob	13
Microphone Feedback Suppressor	14
Initializing the settings via connected controll panels (DCP Setup).....	14
List of DIP Switch Settings	15
[SETUP] DIP switches.....	15
[SPEAKER A] and [SPEAKER B] DIP switches	16

Appendix 17

List of Functions Operated Via the Control Panel.....	17
High-Impedance and Low-Impedance Connections	18
Multiple Speaker System Drive Capability.....	18

Technical Specifications 163

This Setup Guide explains settings to make after installation, and connecting control panels and remote controller.

- The illustrations as shown in this manual are for instructional purposes only, and may appear somewhat different from those on your device.
- The company names and product names in this manual are the trademarks or registered trademarks of their respective companies.

Connections

Attaching Euroblock Plugs

Example (Connection to the [REMOTE] connector)

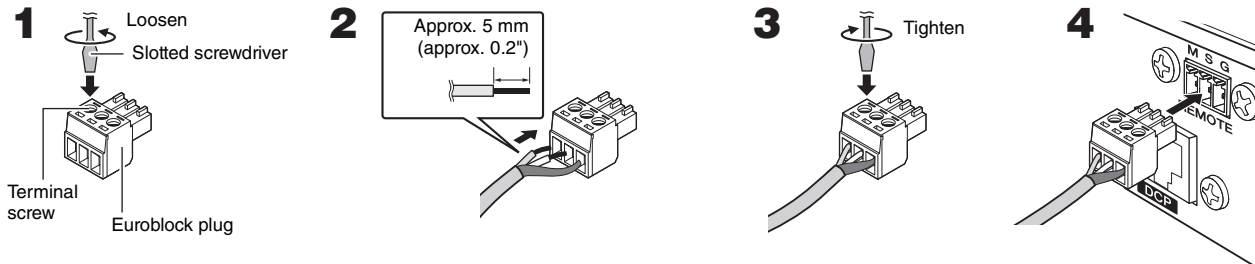

NOTE

- You must use the supplied Euroblock plugs. If the plugs have been lost, please contact your Yamaha dealer.
- Use the 6-pin Euroblock plugs when connecting to the [INPUT] connectors 1-6.
- To prepare the cable for attachment to a Euroblock connector, strip the wire as shown in the illustration using stranded wire to make connections. With a Euroblock connection, stranded wires may be prone to breakage because of metal fatigue due to the weight of the cable or due to vibration. When rack mounting your device, use a lacing bar when possible to bundle and fasten the cables.
- Do not tin (solder) the exposed end.

- 1 Loosen terminal screws.**
- 2 Insert cables.**
- 3 Securely tighten terminal screws.**
- 4 Insert the Euroblock plug into a terminal of this device.**

Connecting Speaker Cables

The [SPEAKERS] output connectors on the rear panel are barrier strip type connectors. The connections are described below for two methods: using a spade lug and using a bare conductor.

⚠ Caution

- Ensure that load is not applied to the speaker cable.
- This device uses a BTL (Balanced Transformer-Less) connection method for the amplifier output. As the amplifier output is sent to the positive and negative connectors, any contact with other terminals or the device chassis may lead to malfunction.

NOTE

Connect the cables so that the amplifier's "+" and "-" symbols match those of the speaker. If they are reversed, the phase will be reversed and the sound will not be output correctly.

When using a spade lug

Loosen the screw, insert the spade lug all the way from below, and tighten the screw.

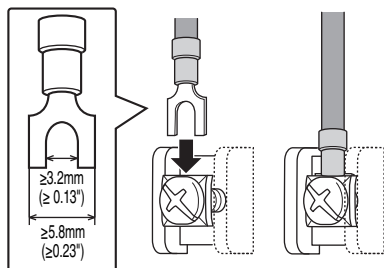

When using a bare conductor

Loosen the screw, wrap the conductor wire around the barrier strip terminal, and tighten the screw. Be sure that the bare wire does not touch the chassis.

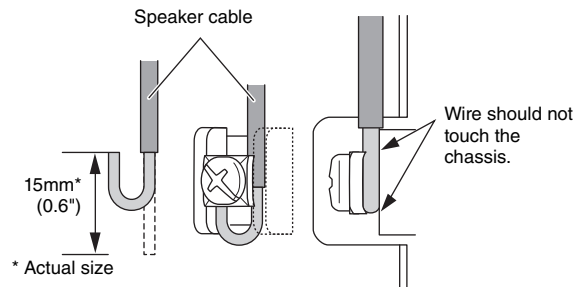

Connecting Microphones or External Devices

Connect a microphone, BGM tuner, CD player or other portable audio player to an [INPUT] connector/jack using an appropriate cable when the device is powered off. After finishing all connections, connect the power cord to an AC outlet.

⚠ Warning

When connecting the power cord to an AC outlet, an input signal will turn on the power of this device by the auto-wake function. To avoid unexpected loud sounds, be sure to connect microphones and external devices with the power off status.

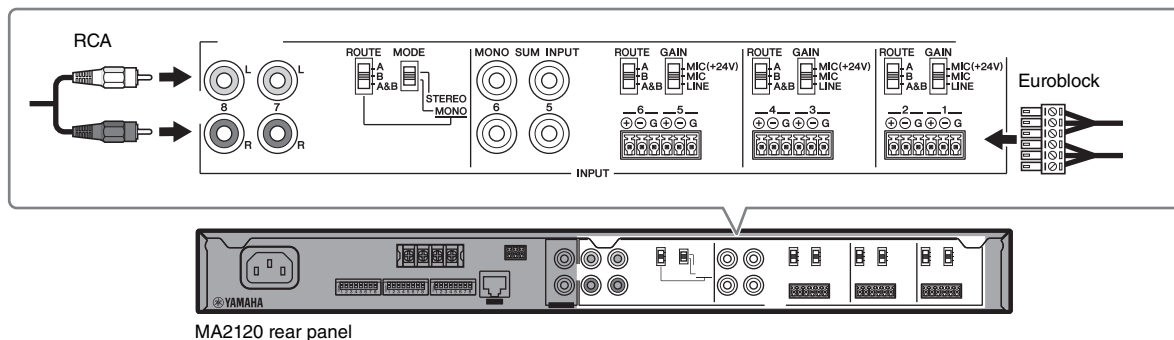

MA2120 rear panel

NOTE

Refer to "Attaching Euroblock Plugs" for Euroblock plug installation.

■ Connecting Microphones

Connect microphones to [INPUT] connectors 1 - 6 using a Euroblock plug.

When using a microphone that requires phantom power (+24V), set the [GAIN] switch to "MIC(+24V)".

For microphones that do not require phantom power, set the [GAIN] switch to "MIC".

⚠ Caution

- Only switch the phantom power on/off when the [VOLUME A] and [VOLUME B] knobs are turned all the way down.
- Keep the phantom power turned off when it is not required, or if you wish to connect a non-supporting device.
- Do not connect or disconnect the cable while phantom power is left on.

■ Connecting External Devices

Use the following procedure to connect a line level external device.

Use a Euroblock plug to connect via [INPUT] connectors 1 - 6. At this time, set the [GAIN] switch to "LINE".

If the external device has an extremely low output level, set the [GAIN] switch to "MIC" to improve the input gain.

Use an RCA cable to connect to [INPUT] jacks 7 and 8. If the source is stereo and you are using zone A and zone B as stereo, set the [MODE] switch to "STEREO". If you are using zone A and zone B separate from each other, set the [MODE] switch to "MONO" and use the [ROUTE] switch to select which zone receives the audio output.

Use a mini-stereo plug to connect via the [AUX IN] jack on the front panel. The signal from the [AUX IN] jack is mixed into the same signal path as [INPUT] jack 8.

■ Using the Mono Sum Input

[INPUT 5] and [INPUT 6] are equipped with mono sum input. Each can be used for summing a line level stereo source, or two separate mono sources. The input signal is mixed directly to mono and output to the zone that was selected using the [ROUTE] switch for [INPUT] jack 5 and 6. Use of the [MONO SUM INPUT] jacks can allow a large number of external devices to be connected without the need for a separate mixer. However, note that when there is also input via Euroblock plugs for [INPUT] connector 5 or 6, the signal input from [MONO SUM INPUT] is mixed in with the signal from [INPUT] connector 5 or 6.

Connecting the PA2120 Power Amplifier

When using a large number of speakers that the MA2120 is not capable of handling alone, it is possible to connect a PA2120 power amplifier to provide extra capacity.

To utilize this functionality, connect the [LINE OUT] jack of the MA2120 to the [INPUT] jack of the PA2120 using an RCA cable when all devices are powered off. If you wish to further expand capacity, it is possible to connect another PA2120 power amplifier. Simply connect the [THRU OUT] jacks of the PA2120 to the [INPUT] jacks of the additional PA2120 power amplifier. After finishing all connections, connect the power cord to an AC outlet.

⚠ Warning

When connecting the power cord to an AC outlet, an input signal will turn on the power of this device by the auto-wake function. To avoid unexpected loud sounds, be sure to connect microphones and external devices with the power off status.

NOTE

When lowering the output level with the [VOLUME] knobs or an external control panel, the Auto-wake function of PA2120 may not work properly because of an absence of input level. Be sure to set the output level to the PA2120 enough for the Auto-wake function to work properly.

MA2120 rear panel

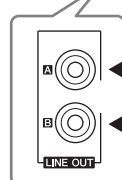
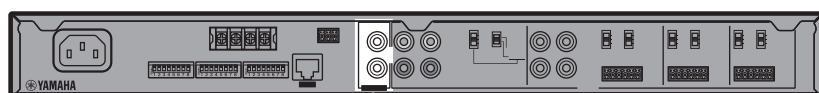

PA2120 rear panel



Further expanding

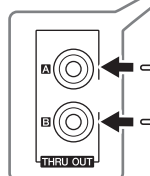

PA2120 rear panel



In setup mode, you can set whether the output level from the MA2120 [LINE OUT] jacks is linked with the output level from the MA2120 [SPEAKERS] terminals, or independently controlled. Set the [VOLUME] knobs of the PA2120 to maximum to adjust the level of PA2120 to the same level of MA2120. Linked operation when using the control panel can be set using the [SETUP] DIP switch.

Connecting a Control Panel

Connecting Yamaha Digital Control Panel (DCP1V4S, DCP4S, DCP4V4S) to MA2120 enables you to control the volume, to switch inputs, etc. remotely. You can connect up to two control panels. The total length of the cables from the MA2120 to the last control panel must not exceed 800 meters in the case of 24AWG.

NOTE

When connecting control panels via DCH8, the total length of the cables to the final control panel must be less than 200m (according to DCH8 specifications). If you need a longer connection, we recommend not using the DCH8, but connecting the devices in a daisy-chain configuration.

Precautions when connecting two control panels:

- Connect them in a daisy-chain configuration.
- Set the panel IDs separately.
- Set the second control panel DIP switch 4 to ON. (termination setting)
This setting is only for the second device when connecting two devices.
- Ensure that the total Ethernet cable length does not exceed 800 meters in the case of 24AWG.

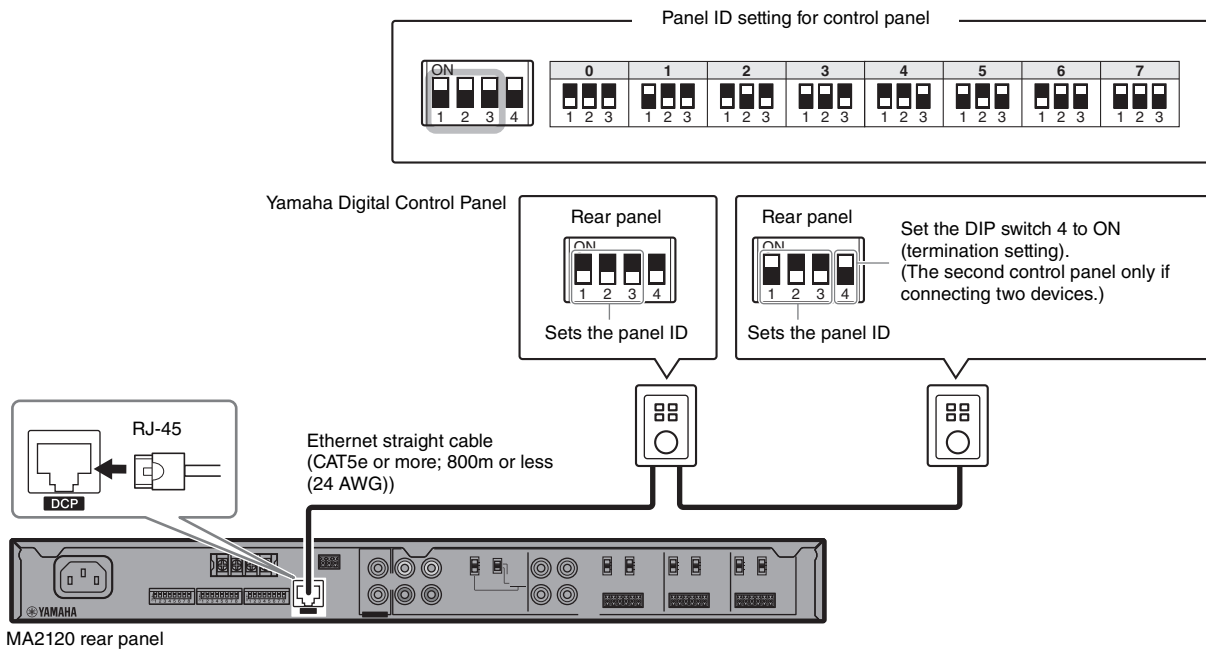

■ Functions Operated Via the Control Panel

Several useful features of the MA2120 power amplifier can be utilized by connecting a control panel.

Linked operation of output levels from [SPEAKERS] terminals and [LINE OUT] jacks

Set the [SETUP] DIP switch on the rear panel to [SPEAKERS+LINE OUT] to allow the output level of the [SPEAKERS] and [LINE OUT] to be controlled together via the control panel.

Input Signal On/Off Switching and Linked Operation

The input channel of a device such as a microphone can be switched on and off by using the switch on the control panel. It is also possible to link on/off operation so that it triggers a chime, or mutes the input signal from [INPUT] jacks 7 and 8.

Using the [REMOTE] Connector (Euroblock 3-pin)

You can connect switches to the rear panel [REMOTE] connector, and use them to remotely mute/unmute outputs of all channels, or switch the power standby/on status.

From the left, the [REMOTE] connector consists of M (mute all), S (standby), and G (ground) pins.

The [REMOTE] connector uses a Euroblock plug. For details on how to connect Euroblock plugs, refer to “Attaching Euroblock Plugs.”

Muting/unmuting all channels

Turning mute on

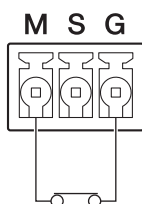

Turning mute off

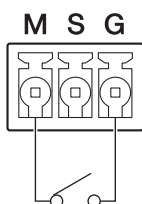

Switching the power standby/on status

Switching the power to standby

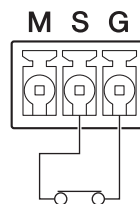

Turning the power on

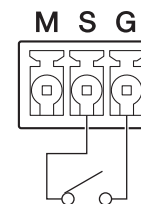

NOTE

- When the device is put into standby mode via the [REMOTE] connector, it is not possible to turn the power back on by pressing the [⏻] button on the front panel, or by the auto-wake function with input signal detection. The power can only be turned on via the [REMOTE] connector.
- When the device is put into mute mode via the [REMOTE] connector, the [🔇] button will flash in green.

Operation Procedure

■ Turning Off the Microphone Input High-Pass Filter

The microphone input high-pass filter (Cut-off frequency: 120Hz) is turned on by default. This can reduce wind or popping noise when using a microphone.

The high-pass filter is enabled for the input channel when the [GAIN] switch is set to either "MIC(+24V)" or "MIC".

NOTE

The high-pass filter is also applied to the [MONO SUM INPUT] when the [GAIN] switch for INPUT 5 and 6 is set to either "MIC(+24V)" or "MIC".

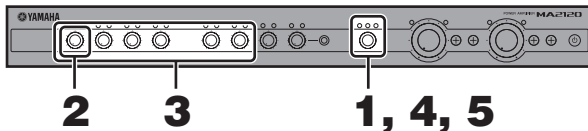

- 1** Press and hold the [SETUP] encoder for at least one second.
- 2** Press input level knob 1.
- 3** Press input level knobs 1 - 6 to select to which input channel you would like to apply the high-pass filter.
- 4** Turn the [SETUP] encoder to switch between on and off.

Off: 

On: (Default setting)

- 5** Press the [SETUP] encoder to apply the setting.

The status is back to the channel select (Step 3).

■ Applying Compressor to the Microphone Input

The microphone input can be run through a compressor that appropriately compresses the input signal, and adjusts the output level automatically.

The compression level is shown as one of seven levels with higher values indicating a higher level of compression.

The compressor is enabled for the input channel when the [GAIN] switch is set to either "MIC(+24V)" or "MIC".

NOTE

The compressor is applied to the [MONO SUM INPUT] when the [GAIN] switch for INPUT 5 and 6 is set to either "MIC(+24V)" or "MIC".

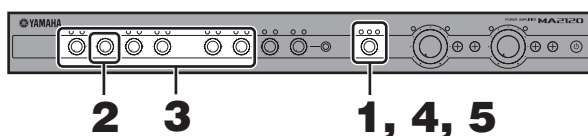

- 1** Press and hold the [SETUP] encoder for at least one second.
- 2** Press input level knob 2.
- 3** Press input level knobs 1 - 6 to select to which input channel you would like to apply the compressor.
- 4** Turn the [SETUP] encoder to adjust the level of compression.

The parameter value changes with each click of the encoder.

Off:  (Default setting)

1:

2 and 3: 

4:

5 and 6: 

7:

- 5** Press the [SETUP] encoder to apply the setting.

The status is back to the channel select (Step 3).

■ Applying EQ (equalizer) to the Input Signal

A two-band EQ (TREBLE and BASS) can be applied to the input signal to adjust the sound quality. The EQ range is $\pm 10\text{dB}$ and can be set in intervals of 1dB.

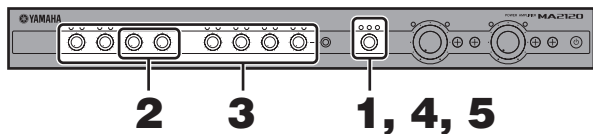

- 1** Press and hold the [SETUP] encoder for at least one second.
- 2** Press input level knob 3 (BASS), or input level knob 4 (TREBLE).
- 3** Press input level knobs 1 - 8 to select to which input channel you would like to apply the EQ.
- 4** Turn the [SETUP] encoder to adjust the level of EQ.

The parameter value changes with each click of the encoder.

-10dB:	<input checked="" type="radio"/>	<input type="radio"/>	<input type="radio"/>	
-9 to -6dB:	<input checked="" type="radio"/>	<input checked="" type="radio"/>	<input type="radio"/>	
-5dB:	<input checked="" type="radio"/>	<input checked="" type="radio"/>	<input type="radio"/>	
-4 to -1dB:	<input checked="" type="radio"/>	<input checked="" type="radio"/>	<input type="radio"/>	
0dB:	<input type="radio"/>	<input checked="" type="radio"/>	<input type="radio"/>	(Default setting)
+1 to +4dB:	<input type="radio"/>	<input checked="" type="radio"/>	<input checked="" type="radio"/>	
+5dB:	<input type="radio"/>	<input checked="" type="radio"/>	<input checked="" type="radio"/>	
+6 to +9dB:	<input type="radio"/>	<input checked="" type="radio"/>	<input checked="" type="radio"/>	
+10dB:	<input type="radio"/>	<input type="radio"/>	<input checked="" type="radio"/>	

NOTE

If the set EQ value for [INPUT 7] and [INPUT 8] exceeds +5dB, the enhancer function starts and harmonic overtones are added.

- 5** Press the [SETUP] encoder to apply the setting.

The status is back to the channel select (Step 3).

■ Applying Echo/Reverb to the Input Signal

Echo/Reverb can be applied to the INPUT 1 and INPUT 3 input signals to add extra sound reverberation. The "Echo" type, which allows for the adjustment of reverberation time, or three "Reverb" types are available.

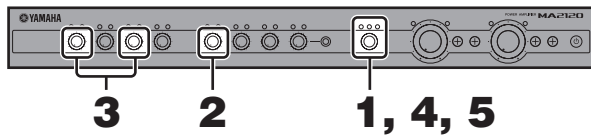

- 1** Press and hold the [SETUP] encoder for at least one second.
- 2** Press input level knob 5.
- 3** Press input level knob 1, or input level knob 3 to select to which input channel you would like to apply the echo/reverb.
- 4** Turn the [SETUP] encoder to select the echo/reverb preset.

The parameter value changes with each click of the encoder.

Off:  (Default setting)

Echo:  (As the echo time is increased, the center indicator flash time becomes longer. The maximum value is indicated by a flash that has a 740ms light-on time.)

Reverb:  (Right indicator flashes for type A and type B. It stays on for type C.)

- 5** Press the [SETUP] encoder to apply the setting.

The status is back to the channel select (Step 3).

■ Adjusting the Reverb Mix Level

You can adjust the mix level of the reverb that is applied to the [INPUT 1] and [INPUT 3] input signals. The percentage of reverb applied to the original signal can be set from 0% to 100%. There are ten possible levels with intervals of 10%.

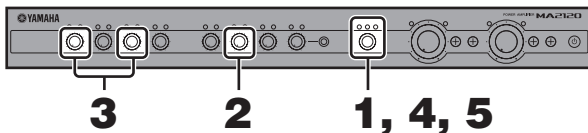

- 1** Press and hold the [SETUP] encoder for at least one second.
- 2** Press input level knob 6.
- 3** Press input level knob 1, or input level knob 3 to select to which input channel you would like to adjust reverb mix level.
- 4** Turn the [SETUP] encoder to adjust the reverb mix level.

The parameter value changes with each click of the encoder.

0%: 

10%:

20% to 40%: 

50%: (Default setting)

60% to 90%: 

100%:

- 5** Press the [SETUP] encoder to apply the setting.

The status is back to the channel select (Step 3).

■ Adjusting the Ducker Sensitivity

You can adjust the sensitivity of the ducker function. When there is an input signal to [INPUT 1] or [INPUT 3], this function can mute the microphone input for channels outside that particular output zone, or lower their line input volume by 24dB.

The ducker input sensitivity can be set to "Low", "Mid", or "High".

NOTE

The ducker function can be turned on or off by switching [SETUP] DIP switches 7 and 8 when the device is powered off or in standby mode.

For more information, refer to "Controls and Functions" of the owner's manual, or "List of DIP Switch Settings" on page 15.

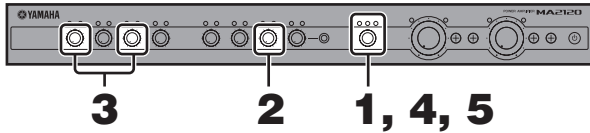

1 Press and hold the [SETUP] encoder for at least one second.

2 Press input level knob 7.

3 Press input level knob 1, or input level knob 3 to select to which input channel you would like to adjust the sensitivity of ducker function.

4 Turn the [SETUP] encoder to adjust the ducker sensitivity.

The parameter value changes with each click of the encoder.

Low:

Mid: (Default setting)

High:

5 Press the [SETUP] encoder to apply the setting.

The status is back to the channel select (Step 3).

■ Regulating BGM Volume (Leveler)

You can select the target level for the leveler function. This function adjusts the volume to an almost constant range when there are [INPUT 7]/[INPUT 8] input signals that have a significant variation in volume.

The leveler function can be used to adjust a signal with a range of up to ± 6 dB. The target level can be set to "Off," "Low" or "Normal."

NOTE

Channels with the leveler function enabled have an output signal delay of approximately 20ms due to the required arithmetic processing.

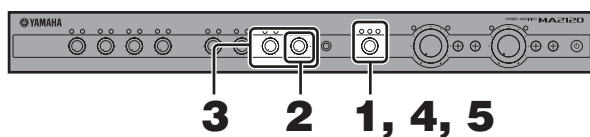

1 Press and hold the [SETUP] encoder for at least one second.

2 Press input level knob 8.

3 Press input level knob 7, or input level knob 8 to apply the leveler function.

4 Turn the [SETUP] encoder to select the target level.

Off: (Default setting)

Low:

Normal:

5 Press the [SETUP] encoder to apply the setting.

The status is back to the channel select (Step 3).

■ Setting the Chime Volume

You can set the volume of the chime that is emitted when the microphone input is turned on or off via by the control panel switch. The volume can be set to "Mute", "-12dB", or "-6dB". You can set different volumes for each zone.

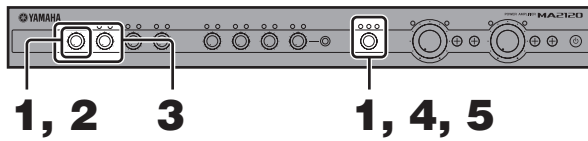

- 1** Press and hold the [SETUP] encoder and input level knob 1 simultaneously for at least one second.
- 2** Press input level knob 1.
- 3** Press input level knob 1 (Zone A), or input level knob 2 (Zone B) to select to which output channel you would like to set the chime volume.
- 4** Turn the [SETUP] encoder to set the volume.
The parameter value changes with each click of the encoder.

Off:

-12dB:

-6dB: (Default setting)

0dB:

- 5** Press the [SETUP] encoder to apply the setting.

The status is back to the channel select (Step 3).

■ Adjusting the Line Out Volume by Using the [VOLUME] Knob

You can turn the linked operation function for [SPEAKERS] and [LINE OUT] on or off. This function allows the output signal level from the [LINE OUT] jack to be simultaneously adjusted when the [VOLUME A] and [VOLUME B] knobs are operated.

NOTICE

When switching this parameter, set the volume of the device connected to the [LINE OUT] connector to minimum.

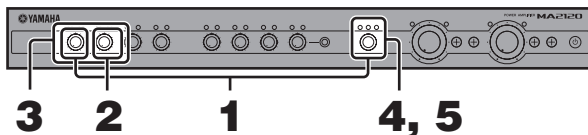

- 1** Press and hold the [SETUP] encoder and input level knob 1 simultaneously for at least one second.
- 2** Press input level knob 2.
- 3** Press input level knob 1 (Zone A), or input level knob 2 (Zone B) to select to which output channel you would like to adjust the line out volume by using the [VOLUME] knob.
- 4** Turn the [SETUP] encoder to turn the linked operation function for [SPEAKERS] and [LINE OUT] on or off.

Off: (Default setting)

On:

- 5** Press the [SETUP] encoder to apply the setting.

The status is back to the channel select (Step 3).

■ Microphone Feedback Suppressor

You can turn the feedback suppressor function on or off. This function automatically suppresses microphone feedback when detected. The feedback suppressor is enabled for the input channel when the [GAIN] switch is set to either "MIC(+24V)" or "MIC".

NOTE

The feedback suppressor is applied to the [MONO SUM INPUT] when the [GAIN] switch for INPUT 5 and 6 is set to either "MIC(+24V)" or "MIC".

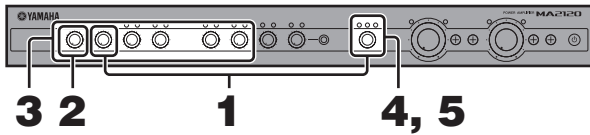

- 1** Press and hold the [SETUP] encoder and input level knob 2 simultaneously for at least one second.
- 2** Press input level knob 1.
- 3** Press input level knobs 1 - 6 to select for which input channels you would like to use the feedback suppressor.
- 4** Turn the [SETUP] encoder to switch between the feedback suppressor on and off.

Off:

On: (Default setting)

- 5** Press the [SETUP] encoder to apply the setting.

The status is back to the channel select (Step 3).

■ Initializing the settings via connected controll panels (DCP Setup)

When turning on the power, this sets whether resuming the settings of connected control panels or initializing.

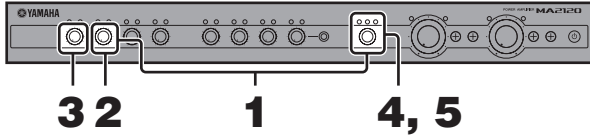

- 1** Press and hold the [SETUP] encoder and input level knob 2 simultaneously for at least one second.
- 2** Press input level knob 2.
- 3** Press input level knob 1.
- 4** Turn the [SETUP] encoder to switch between resuming the previous settings or initializing the settings when turning on the power.

Resume: (Default setting)

Initialize:

- 5** Press the [SETUP] encoder to apply the setting.

The status returns to Step 3.

List of DIP Switch Settings

DIP switch functions are also listed in the “Controls and Functions” section of the owner’s manual.

Only operate DIP switches when the device is powered off or in standby mode. The setting change will be applied after carrying out a power cycle by pressing the [⏻] button on the front panel.

■ [SETUP] DIP switches

DIP switch 1/2: Panel lock

Set knobs and controls to be locked on the panel.

1	2	Setting
<input type="checkbox"/>	<input type="checkbox"/>	Panel lock off (All controls are enabled)
<input type="checkbox"/>	<input checked="" type="checkbox"/>	Locks the [SETUP] knob
<input type="checkbox"/>	<input checked="" type="checkbox"/>	Locks controls other than [VOLUME] knobs
<input checked="" type="checkbox"/>	<input checked="" type="checkbox"/>	Panel lock on (All controls are disabled)

DIP switches 3/4: Auto-wake

Enable the function where the device automatically turns on from standby mode upon detection of an input signal.

3	4	Setting
<input type="checkbox"/>	<input type="checkbox"/>	Auto-wake function on
<input type="checkbox"/>	<input checked="" type="checkbox"/>	Auto-wake function on. Only when the system is switched from AC off to standby mode due to insertion of the AC plug, or put into standby mode by the auto-standby function.
<input checked="" type="checkbox"/>	<input checked="" type="checkbox"/>	Auto-wake function off

NOTE

The auto-wake function is completely disabled if the device has been put into standby mode through operation via the [REMOTE] connector.

DIP switch 5: A - B volume link

Sets whether SPEAKER A and SPEAKER B volume is linked. When linked, the volume for both speakers can be controlled with the [VOLUME A] knob.

5	Setting
<input type="checkbox"/>	Link off (SPEAKER A and SPEAKER B volume levels are independently controlled)
<input checked="" type="checkbox"/>	Link on (SPEAKER A and SPEAKER B volume levels are both controlled via the [VOLUME A] knob)

NOTE

If you turn on “A - B volume link” when the function to allow control of the line out volume A and B by the [VOLUME] knob is enabled in setup mode, LINE OUT A and B are also linked.

DIP switch 6: DCP volume link

Sets whether the [SPEAKERS] and [LINE OUT] jack output levels are linked, when changing the volume via the DCP.

6	Setting
<input type="checkbox"/>	Link off ([SPEAKERS] and [LINE OUT] jack volume levels are controlled separately)
<input checked="" type="checkbox"/>	Link on ([SPEAKERS] and [LINE OUT] jack output is controlled together)

NOTE

When the link function is on, you can control the volume by using both of [SPEAKER] and [LINE OUT] on the control panel.

DIP switches 7/8: Ducker

Configure the settings for the Ducker function. This can mute the microphone input of other channels, and lower the volume of line input when signals are input to [INPUT 1] or [INPUT 3].

7	8	Setting
<input type="checkbox"/>	<input type="checkbox"/>	Ducker off
<input type="checkbox"/>	<input checked="" type="checkbox"/>	Ducker on when signals are input to [INPUT 1].
<input checked="" type="checkbox"/>	<input type="checkbox"/>	Ducker on when signals are input to [INPUT 3].
<input checked="" type="checkbox"/>	<input checked="" type="checkbox"/>	Ducker on when signals are input to [INPUT 1] or [INPUT 3]. If signals are input to both of them, [INPUT 1] is given precedence.

■ [SPEAKER A] and [SPEAKER B] DIP switches

DIP switches 1, 2, and 3: Amplifier mode setup

DIP switches 1, 2, and 3: Amplifier mode setup

NOTICE

If the DIP switch settings do not match the actual speaker impedance or input power rating, the device may have poor performance, and it may even lead to malfunction or sound dropout. Always ensure that appropriate settings are chosen.

1	2	3	Setting
<input type="checkbox"/>	<input type="checkbox"/>	<input type="checkbox"/>	Amplifier output 120W, High-impedance 100V
<input type="checkbox"/>	<input type="checkbox"/>	<input checked="" type="checkbox"/>	Amplifier output 120W, High-impedance 70V
<input type="checkbox"/>	<input type="checkbox"/>	<input type="checkbox"/>	Amplifier output 200W, High-impedance 100V, Output only from [SPEAKERS] output terminal A
<input checked="" type="checkbox"/>	<input type="checkbox"/>	<input type="checkbox"/>	Amplifier output 200W, High-impedance 70V, Output only from [SPEAKERS] output terminal A
<input type="checkbox"/>	<input type="checkbox"/>	<input type="checkbox"/>	Amplifier output 100W, Low-impedance 8Ω or more
<input type="checkbox"/>	<input type="checkbox"/>	<input type="checkbox"/>	Amplifier output 120W, Low-impedance from 4Ω to less than 8Ω
<input type="checkbox"/>	<input type="checkbox"/>	<input type="checkbox"/>	Amplifier output 100W, Low-impedance from 3Ω to less than 4Ω
<input type="checkbox"/>	<input type="checkbox"/>	<input type="checkbox"/>	Output muted

DIP switches 4, 5, and 6: Speaker EQ

Sets the speaker EQ that corrects the output signal to match the type of speakers that are connected.

4	5	6	Setting
<input type="checkbox"/>	<input type="checkbox"/>	<input type="checkbox"/>	Off
<input type="checkbox"/>	<input type="checkbox"/>	<input type="checkbox"/>	High pass filter 150Hz
<input type="checkbox"/>	<input type="checkbox"/>	<input type="checkbox"/>	Low pass filter 150Hz
<input type="checkbox"/>	<input type="checkbox"/>	<input type="checkbox"/>	Low pass filter 200Hz
<input type="checkbox"/>	<input type="checkbox"/>	<input type="checkbox"/>	Frequency correction tailored for Yamaha VXS series speakers
<input type="checkbox"/>	<input type="checkbox"/>	<input type="checkbox"/>	Frequency correction tailored for the Yamaha VXS10S/VXS10ST subwoofer (45-150Hz)
<input type="checkbox"/>	<input type="checkbox"/>	<input type="checkbox"/>	Frequency correction tailored for Yamaha VXC series speakers

Appendix

List of Functions Operated Via the Control Panel

DCP1V4S

Panel ID	Encoder	Switch 1	Switch 2	Switch 3	Switch 4
0, 1	Volume control	_____	_____	Encoder operation target: SPEAKERS A	Encoder operation target: SPEAKERS B
2, 3	Volume control	[INPUT 1] on/off Chime on	[INPUT 3] on/off Chime on	Encoder operation target: SPEAKERS A	Encoder operation target: SPEAKERS B
4, 5	Volume control	[INPUT 1] on/off Chime on Mute [INPUT] 7 and 8	[INPUT 3] on/off Chime on Mute [INPUT] 7 and 8	Encoder operation target: SPEAKERS A	Encoder operation target: SPEAKERS B
6, 7	Volume control	Encoder operation target: LINE OUT A	Encoder operation target: LINE OUT B	Encoder operation target: SPEAKERS A	Encoder operation target: SPEAKERS B

DCP4S

Panel ID	Switch 1	Switch 2	Switch 3	Switch 4
0, 1	Volume up: SPEAKERS A	Volume down: SPEAKERS A	Volume up: SPEAKERS B	Volume down: SPEAKERS B
2, 3	Volume up: LINE OUT A	Volume down: LINE OUT A	Volume up: LINE OUT B	Volume down: LINE OUT B
4, 5	[INPUT 1] on/off Chime on	[INPUT 3] on/off Chime on	_____	_____
6, 7	[INPUT 1] on/off Chime on Mute [INPUT] 7 and 8	[INPUT 3] on/off Chime on Mute [INPUT] 7 and 8	_____	_____

DCP4V4S

Panel ID	Encoder 1	Encoder 2	Encoder 3	Encoder 4
0, 1	Volume control LINE OUT A	Volume control LINE OUT B	Volume control SPEAKERS A	Volume control SPEAKERS B
2	Volume control INPUT 1	Volume control INPUT 2	Volume control INPUT 3	Volume control INPUT 4
3	Volume control INPUT 5	Volume control INPUT 6	Volume control INPUT 7	Volume control INPUT 8
4, 5	Volume control INPUT 1	Volume control INPUT 3	Volume control SPEAKERS A	Volume control SPEAKERS B
6, 7	Volume control INPUT 7	Volume control INPUT 8	Volume control SPEAKERS A	Volume control SPEAKERS B

Panel ID	Switch 1	Switch 2	Switch 3	Switch 4
0, 1	_____	_____	_____	_____
2	[INPUT 1] on/off	[INPUT 2] on/off	[INPUT 3] on/off	[INPUT 4] on/off
3	[INPUT 5] on/off	[INPUT 6] on/off	[INPUT 7] on/off	[INPUT 8] on/off
4, 5	[INPUT 1] on/off Chime on Mute [INPUT] 7 and 8	[INPUT 3] on/off Chime on Mute [INPUT] 7 and 8	_____	_____
6, 7	_____	_____	_____	_____

High-Impedance and Low-Impedance Connections

For a high-impedance connection, a speaker transformer that raises the impedance to several hundred or thousand ohms is added to the speaker system. This allows the speaker system to be effectively driven with much lower current than is required for a low-impedance connection. Therefore, a large number of speaker systems can be connected. Even over long distances, there is very little transmission loss due to the cable resistance being negligible in relation to the impedance of the speaker system. High-impedance speaker connections usually operate at a specific maximum power amplifier voltage of 100 or 70 volts.

The more orthodox low-impedance connection does not use a speaker transformer. The speaker systems are directly connected to the power amplifier with a rated impedance generally around 4 - 16 ohms. For short distances over which cable resistance is insignificant, low-impedance connections deliver a sound quality that is superior to high-impedance connections. The differences between connection methods are explained as follows.

Multiple Speaker System Drive Capability

High-Impedance Connections

As long as the total nominal power input rating for all speakers is within the power output capability of the amplifier, any number of speaker systems can be connected in parallel. The power input rating is determined by the speaker systems and speaker transformers used. It is also possible to connect speaker systems that have different input power ratings. In the case of speaker systems that are capable of changing their input power rating (Yamaha VXC and VXS series, etc.), this can be utilized to vary the volume of each speaker.

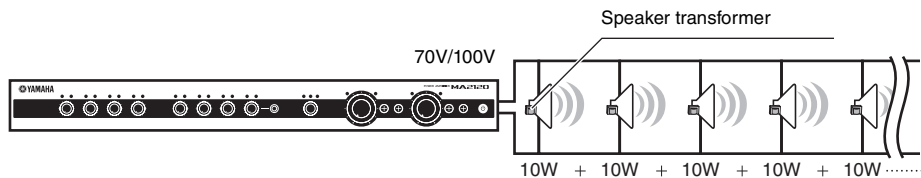

Low-Impedance Connections

When connecting multiple low-impedance speaker systems to a single channel, the following methods are possible.

Parallel Connection

When multiple speaker systems having the same impedance are connected in parallel, the total impedance becomes the individual speaker system impedance divided by the number of systems connected.

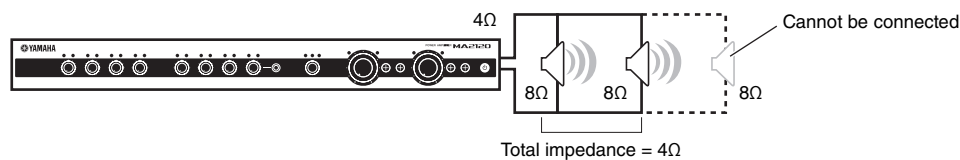

Serial Connection

When connected in series, the total impedance is simply the sum of the impedances of the speaker systems connected. However, if one speaker system happens to fail, the electrical signal will not be passed on and subsequent speaker systems will be affected.

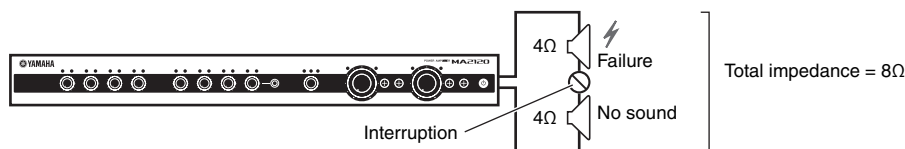

Technical Specifications

Specification

Outputs (SPEAKER OUT)

Output Power 20msec Burst (THD+N=1%)	AMP MODE = 3Ω	100W x 2ch
	AMP MODE = 4Ω	120W x 2ch
	AMP MODE = 8Ω	100W x 2ch
	AMP MODE = 70V/120W	120W x 2ch
	AMP MODE = 100V/120W	120W x 2ch
	AMP MODE = 70V/200W	200W x 1ch
	AMP MODE = 100V/200W	200W x 1ch
Terminal	7.62mm BARRIER STRIP 4pin	

Outputs (LINE OUT)

LINE OUT	Actual source impedance	600Ω
	For use with nominal	10kΩ Lines
Output Level	Nominal	-10dBV (316mV)
Terminal	MONO RCA PIN x2, unbalanced	

Inputs

MIC IN (INPUT 1-6) Input Level INPUT 1-6, Euro, balanced	Sensitivity	-56dBu (1.23mV)	
	Nominal	-36dBu (12.3mV)	
	Max before clip	-8dBu (0.309V)	
LINE IN (INPUT 1-8) Input Level INPUT 1-6, Euro, balanced	Sensitivity	-24dBu (48.9mV)	
	Nominal	-4dBu (0.489V)	
	Max before clip	+24dBu (12.3V)	
	Input Level INPUT 5-8, RCA, unbalanced	Sensitivity	-30dBV (31.6mV)
		Nominal	-10dBV (316mV)
		Max before clip	+10dBV (3.16V)
Input Level INPUT 8, ST mini phone, unbalanced	Sensitivity	-30dBV (31.6mV)	
	Nominal	-10dBV (316mV)	
	Max before clip	+10dBV (3.16V)	
Terminal	MIC/LINE IN	INPUT 1-6 3.5mm Euro Block 6pin x3 balanced	
	LINE IN	INPUT 5-6 MONO RCA PIN x4 unbalanced	
		INPUT 7-8 STEREO RCA PIN x2 unbalanced	
		INPUT 8 (Front Panel) 3.5mm STEREO mini phone x1 unbalanced	

Electrical Characteristics

Amplifier type (Output circuitry)		Class D
THD+N	LINE IN to SPEAKER OUT, Half power@1kHz AMP MODE = 3Ω, 4Ω, 8Ω	≤ 0.2%
	LINE IN to SPEAKER OUT, Half power@1kHz AMP MODE = 70V, 100V/120W	≤ 0.2%
	LINE IN to SPEAKER OUT, Half power@1kHz AMP MODE = 70V, 100V/200W	≤ 0.2%
Frequency Response	LINE IN to SPEAKER OUT, 50Hz to 20kHz@1W AMP MODE = 3Ω, 4Ω, 8Ω	0dB, -3.0dB, +1.0dB
	LINE IN to SPEAKER OUT, 90Hz to 20kHz@1W AMP MODE = 70V, 100V/120W	0dB, -3.0dB, +1.0dB
	LINE IN to SPEAKER OUT, 90Hz to 20kHz@1W AMP MODE = 70V, 100V/200W	0dB, -3.0dB, +1.0dB
	LINE IN to LINE OUT, 20Hz-20kHz	0dB, -2.5dB, +1.0dB
Crosstalk	MIC/LINE IN to other MIC/LINE IN	≤ -70dB
Load Protection	POWER/STANDBY SW on/off	Mute the output
	Output Voltage Protection	Compress output voltage when needed
	DC-fault	Power Supply shutdown
Amplifier Protection	Thermal	Limit output → Mute → Shutdown
	Over current	Mute the output (with automatic restoration)
	Integrated Power Limit	Compress output
Power Supply Protection	Thermal	Power supply shutdown
	Over voltage	Power supply shutdown
	Over current	Limit power → Power supply shutdown
Cooling		Conventional cooling, bottom to up airflow
Controls	Front Panel	POWER/STANDBY SW, INPUT volume x 8, SETUP encoder x 1 OUTPUT volume x 2, BASS EQ volume x 2, TREBLE EQ volume x 2
	Rear Panel	SETUP DIP SW x1, SPEAKER A/B DIP SW x2, ROUTE SW x4, GAIN SW x3, MODE SW x1
Connectors	Analog In (MIC/LINE)	3.5mm Euro Block 6pin x3 (Rear)
	Analog In (LINE)	MONO RCA PIN x4 (Rear), STEREO RCA PIN x2 (Rear), 3.5mm STEREO mini phone x1 (Front)
	Analog Out	MONO RCA PIN x2 (Rear/LINE OUT)
	Speakers	7.62mm BARRIER STRIP 4pin x1 (Rear)
	Remote	RJ45 x1 (Rear/DCP), 3.5mm Euro Block 3pin x1 (Rear/REMOTE)
Indicators		POWER x1 (Green/Orange), INPUT SIGNAL x8 (Green), INPUT PEAK x8 (Red), SETUP x3 (Green), OUTPUT SIGNAL x2 (Green), OUTPUT LIMIT x2 (Red)
AC Power Requirement		100V, 120V, 230V-240V 50Hz/60Hz (*1) *1 It has confirmed that it is working with ±10% of the voltage of the rated supply voltage.

Power Consumption	Standby, default setting AMP MODE = All	≤ 1W
	Idle AMP MODE = 3Ω, 4Ω, 8Ω	15W
	Idle AMP MODE = 70V, 100V	20W
	1/8 Output, Pink noise AMP MODE = 4Ω	60W
	1/8 Output, Pink noise AMP MODE = 70V/120V	60W
ENERGY STAR		<ul style="list-style-type: none"> • It automatically enters into standby mode when no input signal is detected for 25 minutes in order to save power while not in use. • Amplifier efficiency: 44% and more. • Less than 1W in standby.

General Specifications

Precautions for rack mounting	Rack mountable (Leave more than 1U of spaces between this unit and others.)
Operating temperature	0°C to +40°C
Storage temperature	-20°C to +60°C
Dimensions (W x H x D, not including knob)	480 x 44 x 351 mm 18.90 x 1.73 x 13.82 inch
Net Weight	4.9kg
Included Accessories	AC power cord (2.0m) x1, 3.5mm Euroblock plug (6pin) x3, 3.5mm Euroblock plug (3pin) x1, Owner's Manual x1, Setup Guide x1
Optional accessories	Digital Control Panel (DCP1V4S-US/EU, DCP4V4S-US/EU, DCP4S-US/EU)

Dimensions

(unit: mm)

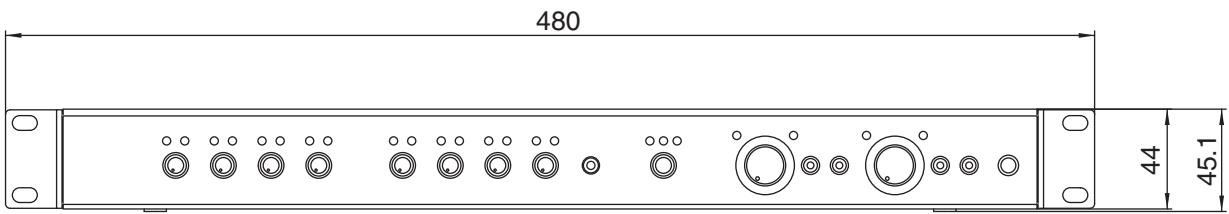
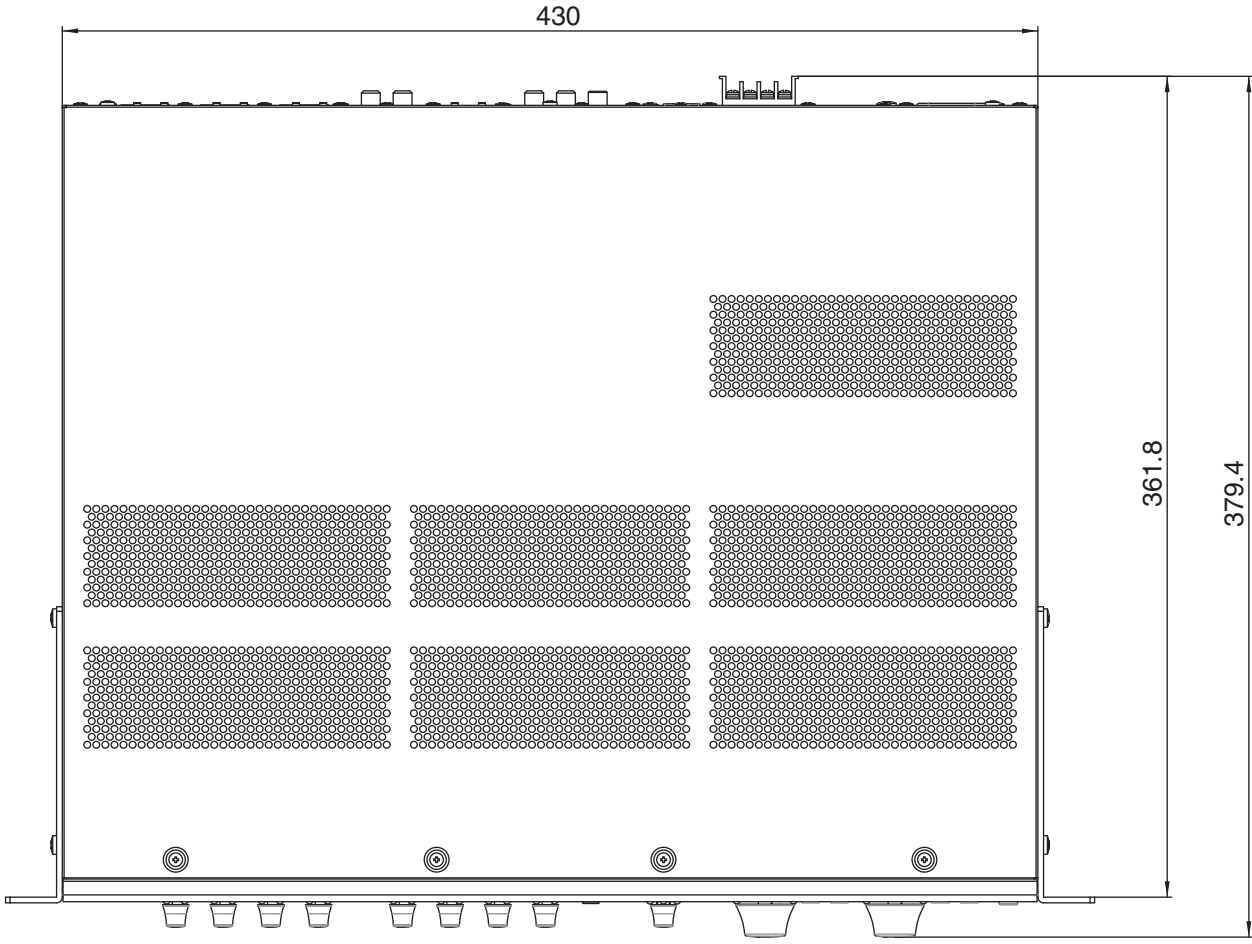

Block Diagram

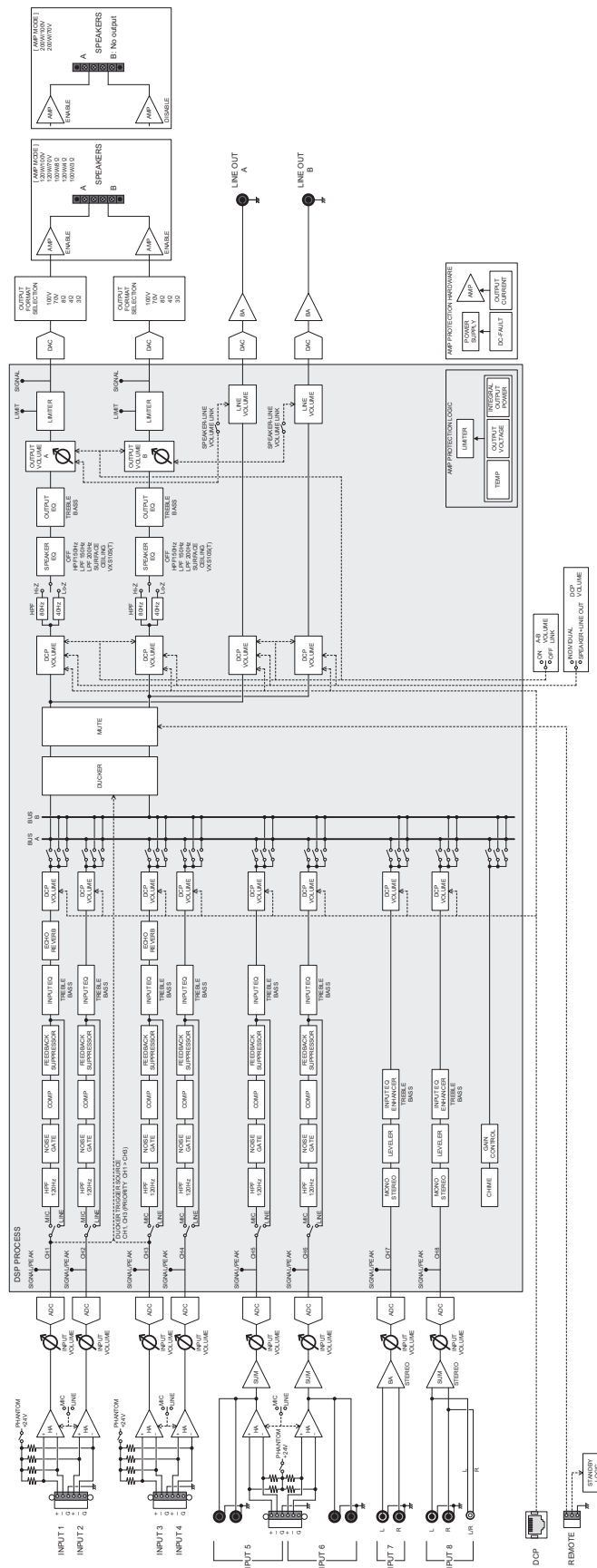

Level Diagram

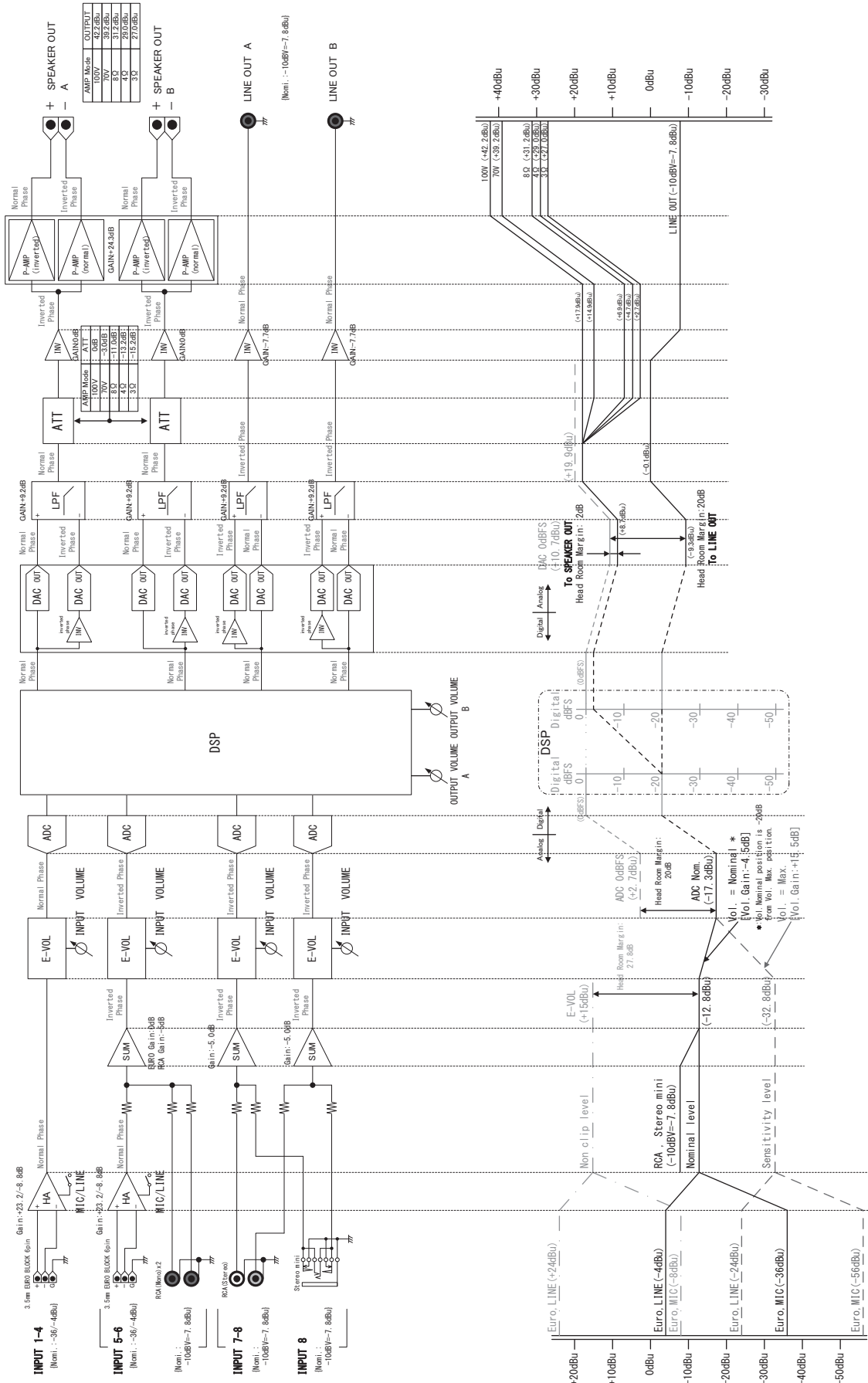

Current Draw

1/8 power is typical of program material with occasional clipping. Refer to these figures for most applications.

1/3 power represents program material with extremely heavy clipping

Test signal: Pink Noise, bandwidth limited from 22Hz to 22kHz

1W = 0.860kcal/h, 1BTU = 0.252kcal

Note that Line Voltage [V] x Line Current [A] = [VA], not equals to [W]

230V/50Hz		Line Current (A)	Watt (W)			Thermal Dissipation	
		230V	In	Out	Dissipated	Btu/h	kcal/h
Sleep		0.10	3.3	0.0	3.3	11.3	2.9
Idle	AMP-MODE : 3Ω/4Ω/8Ω	0.21	18	0.0	18	60	15
	AMP-MODE : 120W-70V/100V	0.26	23	0.0	23	79	20
	AMP-MODE : 200W-70V/100V	0.22	18	0.0	18	63	16
1/8 output power	AMP-MODE : 3Ω	0.54	52	23	29	99	25
	AMP-MODE : 4Ω	0.57	56	26	30	103	26
	AMP-MODE : 8Ω	0.52	50	24	26	89	22
	AMP-MODE : 120W-70V	0.55	53	25	28	96	24
	AMP-MODE : 120W-100V	0.55	53	26	27	93	23
	AMP-MODE : 200W-70V	0.49	47	23	24	82	21
	AMP-MODE : 200W-100V	0.48	46	23	23	79	20
1/3 output power	AMP-MODE : 3Ω	1.02	106	61	45	154	39
	AMP-MODE : 4Ω	1.10	115	68	47	161	41
	AMP-MODE : 8Ω	0.98	101	63	38	130	33
	AMP-MODE : 120W-70V	1.01	105	67	38	130	33
	AMP-MODE : 120W-100V	1.02	106	69	37	127	32
	AMP-MODE : 200W-70V	0.91	94	60	34	117	29
	AMP-MODE : 200W-100V	0.90	92	61	31	106	27

120V/60Hz		Line Current (A)	Watt (W)			Thermal Dissipation	
		120V	In	Out	Dissipated	Btu/h	kcal/h
Sleep		0.08	2.5	0.0	2.5	8.6	2.2
Idle	AMP-MODE : 3Ω/4Ω/8Ω	0.28	16	0.0	16	54	14
	AMP-MODE : 120W-70V/100V	0.37	21	0.0	21	72	18
	AMP-MODE : 200W-70V/100V	0.30	17	0.0	17	57	14
1/8 output power	AMP-MODE : 3Ω	0.87	52	23	29	99	25
	AMP-MODE : 4Ω	0.92	55	25	30	103	26
	AMP-MODE : 8Ω	0.82	49	24	25	86	22
	AMP-MODE : 120W-70V	0.88	52	25	27	93	23
	AMP-MODE : 120W-100V	0.88	52	26	26	89	22
	AMP-MODE : 200W-70V	0.78	46	23	23	79	20
	AMP-MODE : 200W-100V	0.77	45	23	22	75	19
1/3 output power	AMP-MODE : 3Ω	1.65	107	61	46	158	40
	AMP-MODE : 4Ω	1.78	117	68	49	168	42
	AMP-MODE : 8Ω	1.59	102	63	39	134	34
	AMP-MODE : 120W-70V	1.64	106	67	39	134	34
	AMP-MODE : 120W-100V	1.65	107	69	38	130	33
	AMP-MODE : 200W-70V	1.49	94	60	34	117	29
	AMP-MODE : 200W-100V	1.46	93	61	32	110	28

100V/50Hz		Line Current (A)	Watt (W)			Thermal Dissipation	
		100V	In	Out	Dissipated	Btu/h	kcal/h
Sleep		0.07	2.4	0.0	2.4	8.2	2.1
Idle	AMP-MODE : 3Ω/4Ω/8Ω	0.31	16	0.0	16	54	14
	AMP-MODE : 120W-70V/100V	0.42	21	0.0	21	73	18
	AMP-MODE : 200W-70V/100V	0.33	17	0.0	17	57	14
1/8 output power	AMP-MODE : 3Ω	0.99	52	23	29	99	25
	AMP-MODE : 4Ω	1.05	55	25	30	103	26
	AMP-MODE : 8Ω	0.94	49	23	26	89	22
	AMP-MODE : 120W-70V	1.00	53	25	28	96	24
	AMP-MODE : 120W-100V	1.00	53	26	27	93	23
	AMP-MODE : 200W-70V	0.90	46	23	23	79	20
	AMP-MODE : 200W-100V	0.87	45	23	22	75	19
1/3 output power	AMP-MODE : 3Ω	1.90	108	61	47	161	41
	AMP-MODE : 4Ω	2.05	119	68	51	175	44
	AMP-MODE : 8Ω	1.83	103	63	40	137	35
	AMP-MODE : 120W-70V	1.89	107	67	40	137	35
	AMP-MODE : 120W-100V	1.91	108	69	39	134	34
	AMP-MODE : 200W-70V	1.71	95	60	35	120	30
	AMP-MODE : 200W-100V	1.68	94	61	33	113	29



雅马哈乐器音响（中国）投资有限公司
上海市静安区新闻路1818号云和大厦2楼
客户服务热线：4000517700
公司网址：<http://www.yamaha.com.cn>

厂名：雅马哈电子（苏州）有限公司
厂址：江苏省苏州市苏州新区鹿山路18号

Yamaha Pro Audio global website
<http://www.yamahaproaudio.com/>

Yamaha Downloads
<http://download.yamaha.com/>

Manual Development Department
© 2016 Yamaha Corporation

Published 02/2016 发行 KSHD-A0
Printed in China

ZT16370